

# **Low Impact Development Appendix to the *Connecticut Stormwater Quality Manual***

## **Partners for the Connecticut Low Impact Development and Stormwater General Permit Evaluation** Connecticut

August 2011



146 Hartford Road  
Manchester, CT 06040

# Table of Contents

## Low Impact Development Appendix to the *Connecticut Stormwater Quality Manual*

### Partners for the Connecticut Low Impact Development and Stormwater General Permit Evaluation

---

<b>1</b>	<b>Introduction to Low Impact Development.....</b>	<b>1</b>
<b>2</b>	<b>LID Planning and Design Process .....</b>	<b>4</b>
2.1	<b>Basic Planning Principles.....</b>	<b>5</b>
2.2	<b>Site Planning and Design Process.....</b>	<b>8</b>
2.2.1	Step 1 – Define Basic Project Objectives and Goals.....	9
2.2.2	Step 2 – Site Evaluation and Analysis.....	9
2.2.3	Step 3 – Optimize Conservation of Natural Features at the Larger Watershed Scale .....	10
2.2.4	Step 4 – Minimize Impacts at the Lot Level.....	11
<b>3</b>	<b>Use of Integrated Management Practices in Various Settings..</b>	<b>12</b>
3.1	<b>Integrated Management Practices in a Residential Setting .....</b>	<b>12</b>
3.2	<b>Integrated Management Practices for High Density Industrial, Commercial and Residential Development .....</b>	<b>14</b>
3.3	<b>LID Roadway Designs .....</b>	<b>16</b>
3.3.1	Open Section Roadways .....	16
3.3.2	CUL-DE-SAC Designs.....	18
3.3.3	Divided Highways.....	19
3.3.4	Highly Urbanized LID Street Design .....	20
3.3.5	Porous Surfaces.....	20
3.3.6	Other LID Roadway Design Considerations .....	21
3.4	<b>Urban Retrofit and Redevelopment .....</b>	<b>22</b>
3.4.1	Retrofit Case Studies .....	22
<b>4</b>	<b>Design Standards for Low Impact Development Controls ....</b>	<b>25</b>
4.1	<b>Approaches that Optimize Conservation .....</b>	<b>25</b>
4.1.1	Limits of Clearing and Grading.....	25
4.1.2	Preserving Natural Areas .....	27
4.2	<b>Approaches that Mimic Natural Water Balance .....</b>	<b>32</b>
4.3	<b>Approaches to Minimizing and Disconnecting Impervious Surface.....</b>	<b>36</b>
4.3.1	Roadways .....	36
4.3.2	Buildings.....	38
4.3.3	Parking Footprints.....	40
4.3.4	Parking Lot Islands.....	42
4.3.5	Permeable Pavement .....	43
4.3.6	Disconnecting Impervious Areas .....	44



# Table of Contents

## Low Impact Development Appendix to the *Connecticut Stormwater Quality Manual*

### Partners for the Connecticut Low Impact Development and Stormwater General Permit Evaluation

Figures	Page	
3.8	Examples of center median infiltration/filtration systems	19
3.9	Shoulder Treatment Systems using detention and filtration design	20
3.10	Examples of planter box designs in high density development	20
3.11	Porous surfaces	21
3.12	Permeable pavement and rain garden/bioretention retrofits along North Main Street in Bridgeport, CT	23
3.13	Green roof on subsurface building at Hartford Green Capitols Project	23
3.14	Construction of a rain garden at Hartford Green Capitols Project.	23
3.15	Permeable pavement at Hartford Green Capitols Project.	24
3.16	Retrofit and redevelopment techniques in Connecticut	24
4.1	Reduced limits of disturbance minimize water quality impacts	26
4.2	Site map with natural areas delineated	28
4.3	Riparian buffer along the French River in Thompson, CT	28
4.4	Three-zone riparian buffer	29
4.5	Rock trench level spreader for low flows	30
4.6	Alternative roadway design in Waterford, CT	35
4.7	Different Styles of turnarounds	36
4.8	Cul-de-sac infiltration island accepts stormwater from surrounding pavement	36
4.9	Reduced road widths	37
4.10	Reduced side yards	39
4.11	Examples of nontraditional lot designs	40
4.12	Parking deck – New Haven, CT	41
4.13	Bioretention in a parking lot island in Branford, CT	42
4.14	Parking lot with islands attractively integrated	43
4.15	Permeable pavement	43
4.16	Standards for disconnecting impervious surface via sheet flow	46
4.17	Standards for disconnecting impervious surface via downspouts	47
4.18	Vegetative filter strip	48
4.19	Drawing of a vegetative filter strip	49
4.20	Vegetated drainage way	49
4.21	Aetna Building, Hartford, CT	50
4.22	Roof ponding rings	55
4.23	Example Vegetated Rooftop Cross-section	57
4.24	Example of a rain barrel	58
4.25	Schematic of drywell with optional sump to facilitate cleanout	59
4.26	Bioretention at University of Connecticut Storrs Campus	60
4.27	Rain garden	61
4.28	Infiltration trench	61

# 1 Introduction to Low Impact Development

Traditionally, stormwater has been managed using large, structural practices installed at the low end of development sites—essentially as an afterthought—on land segments left over after subdividing property. This approach, sometimes referred to as end-of-pipe management, yields the apparent advantages of centralizing control and limiting expenditure of land. Unfortunately, end of pipe technology has been shown to have many economic and environmental limitations such as failure to meet receiving water protection goals, high construction, operation and maintenance costs, certain health and safety risks and limited use for urban retrofit. In response to these deficiencies an alternative technological approach has emerged that is generally more economical and potentially provides far better environmental protection. This new approach is referred to as LID.

In contrast to conventional centralized end-of-pipe management, LID uses numerous site design principles and small-scale treatment practices distributed throughout a site to manage runoff volume and water quality at the source. For new development, LID uses a planning process to employ site design techniques to first optimize conservation of natural hydrologic functions to prevent runoff. If these conservation practices are insufficient to meet required stormwater goals then engineered at the source treatment practices are used to meet volume and water quality objectives.

LID's distributed techniques provide retention, detention and filtration of runoff in a manner that more closely mimics the natural water balance (interception, interflow, infiltration and evapotranspiration). This is accomplished through the cumulative effects of using an array of runoff reduction techniques, small scale nonstructural or engineered practices to treat runoff. Further the uniform distribution of controls throughout a site increases runoff time of travel and concentration dramatically reducing discharge flows and increasing opportunities for infiltration and filtration within landscape features.

With appropriate selection, application and design, LID principles and practices can be used in any land planning type, soils, climate or hydrologic regime. For example, in soils with high infiltration rates LID practices may heavily rely on infiltration. For high density urban or retrofit development infiltration may not be desirable or possible; therefore, filtration, detention and runoff capture-and-use practices would be more applicable. In cold climate filtration-infiltration practices must be designed to minimize freezing allowing treatment when needed. LID principles and practices are highly adaptable and can be customized for any development scenario or receiving water goal.

The creation of LID's wide array of small-scale management principles and practices has led to the development of new tools to retrofit existing urban development. Small-scale practices can be easily integrated into existing green space, streetscapes and parking lots as part of the redevelopment process or through routine maintenance and repair of urban infrastructure. As urban areas redeveloped with integrated LID techniques, over time it will be possible to dramatically reduce pollutant loads to receiving waters to restore impaired waters.

However, the use of LID practices does not necessarily supplant the need for end-of-pipe technology. Hybrid approaches, which incorporate both types of practices, may be needed to

meet stringent water quality and flood control requirements. However, as LID's decentralized practices can better reduce adverse environmental impact, Connecticut regulatory agencies will typically expect permit applicants first carefully consider all opportunities to use such practices prior to exploring end-of-pipe management. The use LID techniques alone or in combination with conventional techniques will not only reduce adverse water quality impact, but will help to restore vital ecological processes necessary to restore or sustain the ecological integrity and quality of our water resources.

LID represents an alternative approach to controlling stormwater runoff that provides effective new tools to restore or maintain a watershed's hydrologic functions for both new and existing development. LID is still relatively new and rapidly evolving stormwater management technology. It was first described in 1999 in the Prince George's County, Maryland, *Low-Impact Development Design Strategies: An Integrated Design Approach*. However, today due to LID's many economic and environmental advantages over conventional end-of-pipe technology, it has been widely and rapidly adopted throughout the country. This LID design guidance has been developed using the latest information and past lessons learned to provide the most up to date design guidance.

LID practices are commonly used on reparations made to current structures that have caused issues with stormwater runoff and the resulting water quality. However, LID practices can also be considered during new building construction and implementation. LID uses many decentralized small-scale management practices strategically located throughout a development to conserve and engineer the urban landscape in a manner that mimics predevelopment hydrologic conditions. Ideally, these LID practices are seamless in the developed environment as all traditional site features are designed to be multifunctional. Residential, commercial, and industrial properties look the same but the landscape features are designed to provide water quality and hydrologic functions to storage, detain, filter, and infiltrate runoff. Typical advantages of LID's integrated approach over the conventional end-of-pipe approach include:

- Reduced consumption of land for stormwater management – LID practices provide opportunities to integrated controls into all aspects of a site's hardscape and landscape features. This allows multifunctional use of the entire developed site for controls allowing the most cost effective use of land. Less land is needed or consumed for end-of-pipe controls often allowing for more developable space.
- LID does not dictate particular land-use controls – Since LID is a technological approach there is no need to change conventional zoning or subdivision codes accept to allow LID's use. This means LID does not reduce development potential and with less land consumed for stormwater controls lot yields may increase.
- Reduced construction costs – Traditional stormwater management requires significant storm sewer and earthwork. LID practices apply controls as close to sources of runoff as possible. Wherever practicable, conveyances incorporate natural flow paths and swales instead of pipes. Structures installed are small, thus reducing the need for excavation and construction materials.

- Ease of maintenance – LID landscape practices require limited maintenance or no increase in maintenance beyond typical landscape care. Much of the maintenance required can be accomplished by the average landowner. Further many LID site planning, conservation, and grading techniques require no maintenance.
- Takes advantage of site hydrology – Conservation of natural resources, topography, land cover, soils, and drainage features preserve the natural hydrologic functions allowing absorption of runoff from impervious surfaces. Runoff that is absorbed recharges groundwater and stream base flow and does not need to be managed or controlled by an end-of-pipe practice. Preserving and maintaining the natural hydrology also better protects streambank stability and riparian habitat.
- Better quality of discharge – Recent research indicates conventional end-of-pipe controls are unable reduce pollutant concentrations below certain thresholds, which may exceed water quality standards. However, LID techniques have shown to be far more effective in reducing the annual pollutant loads through both volume reduction and filtration of runoff. Use of natural landscape features and use of lot-level bioretention and swales may, in many cases, allow for retention all runoff from events smaller than the 2-year, 24-hour storm and significantly reduce peak discharges from larger storms.
- More aesthetically pleasing development – Traditional stormwater management tends to incorporate the use of large, unnatural looking practices such as detention ponds. When neglected, these practices may present drowning and mosquito breeding hazards. Nonstructural and upland practices optimize use of landscape features that are more aesthetically pleasing and fit well into the natural landscape.
- Multiple benefits – LID has shown to provide multiple benefits such as reducing energy cost by using green roofs and proper location of trees for shading and water conservation by using rain water as a supplemental water supply.
- Improved profit margin – The advantages of nonstructural and upland management translate into the marketplace. The value added is significant. Several studies indicate that the cost of applying these nonstructural and upland stormwater management techniques is about half that of the traditional approach. The results of one example of such a study are summarized in *Table 1.1* below (Schuler, 2000). Properties developed using nonstructural and upland stormwater practices tend to command higher sale prices.



**Table 1.1  
Cost Analysis for Conventional and Alternative Development**

<b>Cost Categories</b>	<b>Conventional Development</b>	<b>Alternative Development<sup>a</sup></b>
Engineering	\$79,600	\$39,800
Road Construction	(20,250 linear ft.) \$1,012,500	(9,750 linear ft.) \$487,500
Sewer and Water	\$25,200	\$13,200
Other Costs	\$111,730	\$54,050
<b>Total</b>	<b>\$1,229,030</b>	<b>\$594,550</b>

Source: Center for Watershed Protection, 2000, *The Practice of Watershed Protection*, page 175.

Notes:

<sup>a</sup>Alternative development cost analysis was done for cluster development, which is similar to conservation development.

## 2 LID Planning and Design Process

LID represents a new philosophy in stormwater management. Runoff is viewed as a resource and hydrology used as an organizing principle for site design. Learning how to work with rain water in the landscape rather than just quickly disposing of it. LID is an ecologically friendly approach to site development and stormwater management that aims not just to minimize development impacts (reduce impervious surfaces), but instead restore vital watershed ecological processes (natural hydrologic regime) necessary to restore and maintain the physical and biological integrity of waters and the quality of life.

LID uses new management principles such as conservation of soils and drainage patterns; using integrated decentralized controls; uniform distribution of lot-level controls to increase runoff storage, contact time and time of travel; and, multifunction landscape features engineered to make the most cost effective use of space. The landscape is comprehensively engineered and optimized for stormwater controls. All of these principles are in direct contrast to conventional end-of-pipe treatment. *Figure 2.1* and *Figure 2.2* contrasts conventional centralized controls with a LID decentralized approach.



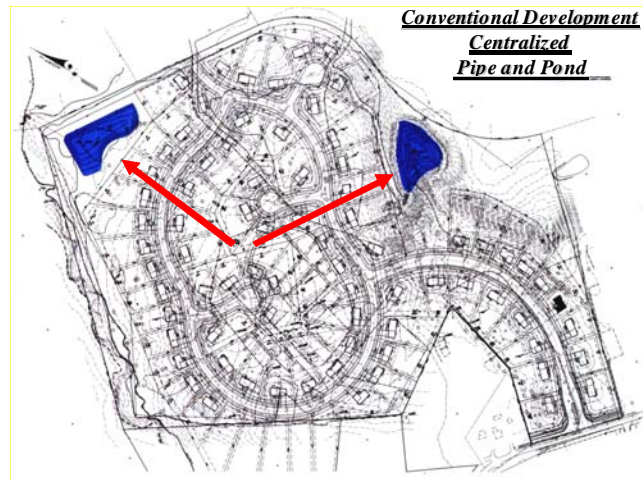

**Figure 2.1 – Conventional Controls.** A conventional approach requires clear cutting, mass grading and use impervious surfaces, gutters pipes and ponds to collect and treat runoff. This approach completely alters and destroys the natural hydrology and ability of the landscape to absorb rainwater and capture pollutants.

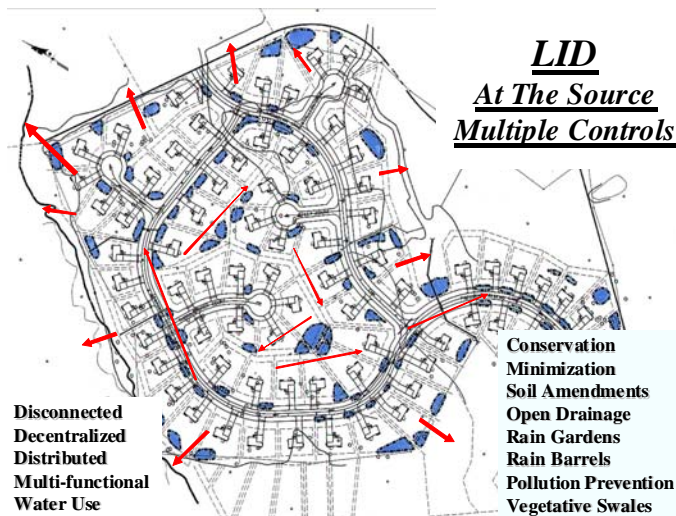

**Figure 2.2 – LID Controls.** A LID approach use a wide array of techniques that work with the landscape, soils, drainage patterns and vegetation to minimize impacts and integrated management controls to retain, detain, infiltrate and filter runoff. LID can provide better stormwater controls by mimicking the pre-development hydrology. Often LID designs increase lot yield and reduce infrastructure cost.

To optimize the benefits of LID, there is also a specific site planning and design process to follow. This process includes optimizing conservation at the larger project level; minimize impacts at site level, maintaining drainage features and use of engineered integrated management practices. The principles and design processes are explained in more detail below.

## 2.1 Basic Planning Principles

A well-designed integrated stormwater management system will minimize the volume of runoff generated and maximize the treatment capabilities of the landscape. A LID design controls runoff as close to the source as possible. A well-designed system should also be easy to

maintain, not interfere with the typical use of the property, and be aesthetically pleasing. To optimize a LID design, it is important to consider a number of site planning principles and follow a systematic design processes from the very beginning. Each site has a unique set of characteristics and will require the use of a unique blend of site specific LID planning and treatment techniques. In considering the advantages and constraints of each site, four fundamental concepts should remain preeminent:

**1. Minimizing site disturbance**

Undisturbed lands possess a natural capacity to store runoff waters. Development sites may include areas that are relatively sensitive to impact from construction (e.g., erosion) or may encompass particularly rare or valuable environmental features. Protecting susceptible natural features provides the multiple benefits of preserving important resources, reducing development impact and providing capacity for prevention of erosion.

Generally, developers should inventory and map natural features such as surface waters, vegetated wetlands and highly erodible soils, for preservation early in the site planning process. This helps to define a practicable development envelope. Preserved areas must be protected throughout construction and demarcated for conservation in land records.

**2. Working with site hydrology**

Traditional erosion prevention seeks to eliminate the annoyance and hazard of runoff by rapidly conveying it away from development—typically, via closed drainage systems such as storm sewers. This approach works efficiently to remove water from streets and sidewalks, but it expends significant capital for constructed systems that interrupt the recharge of groundwater resources. By contrast, LID techniques work to reduce stormwater generation or retain it in the upland where it can percolate naturally into the soil and replenish groundwater resources.

**3. Minimizing and disconnecting impervious surface**

Runoff comes primarily from impervious surface, such rooftops, roadways or any smooth hard surface that prevents water from absorbing into the ground. Traditional developments tend to include superfluous impervious surface, which may be minimized with thoughtful site planning. Techniques to limit impervious area include reducing road widths and lengths as well as the area of rooftops (e.g., preference for multi-story over single-story buildings).

To the extent possible, developers should promote contact between runoff and pervious land surface. Technically, this is done by increasing time of concentration—length of time required for runoff to concentrate and flow off site—and by reducing the runoff curve number.

**4. Applying small-scale controls at the source**

Small-scale practices applied at the source—or as close as practicable—can offer significant advantages over conventional, engineered facilities such as ponds or concrete conveyances. They can decrease the use of typical engineering materials such as steel and concrete. By using materials such as native plants, soil and gravel these systems can be more easily integrated into the landscape and appear to be much more natural than

engineered systems. The natural characteristics may also increase homeowner acceptance and willingness to adopt and maintain such systems. Small, distributed systems also offer a major technical advantage—one or more of the systems can fail without undermining the overall integrity of the site control strategy.

Small-scale practices reduce safety concerns as they feature shallow basin depths and gentle side slopes. The integration of these facilities into the landscape throughout the site offers more opportunities to mimic the natural hydrologic functions and add aesthetic value. The adoption of these landscape features by the general public and individual property owners can result in significant maintenance and upkeep savings to the homeowners association, municipality or other management entity.

Another important factor in LID design is that it is best applied by a multidisciplinary team of professionals. The contributions of soils scientist, biologist, landscape architects, urban planners, and engineers are all equally important. It is not just about meeting the volume storage and flow regulatory requirements, it is about professionals using their combined knowledge and skills to create and design the most ecologically functional, economically viable, aesthetically pleasing livable community possible.

Several basic LID planning principles should remain in the forefront throughout the various steps of the site planning and design process. These principles require a completely different way of thinking about site design than current convention.

For example, an important LID concept is to keep water on the site as long as possible using the landscape to treat runoff, but without causing flooding problems or interfering with the typical use of the property.

This is in contrast to the current practice of grading a site to quickly move water away from buildings and roadways. Until LID designs become the normal way of doing business a good design will require more time and creativity to manage runoff within the landscape effectively.

Basic LID principles include:

1. Optimize conservation – Save natural resource areas, vegetation and soils and wisely use them to reduce and treat runoff to maintain the site's ability to retain and detain runoff.
2. Mimic the natural water balance – To the extent possible continue to store detain and infiltrate water in the manner and rate as predevelopment. This requires careful evaluation of site soils in order to save sandy soils and use these areas as part of the LID



Figure 2.3 – Key elements of LID.

control strategy. Conserving natural drainage features and topography will help to maintain the natural frequency of discharges.

3. Disconnect Impervious Surfaces – Always disconnect impervious surfaces. The site's runoff characteristics are completely changed when impervious surfaces drain to landscape features or engineered LID practices. This approach prevents the adverse cumulative effects of collecting and concentrating flows and helps to reduce erosion problems.
4. Decentralize and Distribute Controls – The more LID techniques used and the more uniformly distributed throughout the landscape the more effective LID becomes. Increasing runoff time of travel significantly reduces flows and discharge frequencies. Increasing storage features decreases runoff volume and reduces annual pollutant loads. Utilizing all landscape features for filtration increases its capacity to capture and cycle pollutants.
5. Multifunctional/Multipurpose Landscapes – Every aspect of the urban landscape can be design to either reduce or restore hydrologic functions. Every landscape feature should be optimized to provide beneficial hydrologic and water quality functions by preventing, storing, retaining, detaining, and treating runoff.
6. Cumulative Impacts of Multiple Systems – LID relies on cumulative beneficial impacts of an array of LID planning and design principles and various treatment practices. As more LID techniques are used to store or detain runoff, the developed site also more closely replicates the natural hydrologic regime. One interesting aspect of LID--because so many techniques are used, failure of a few practices does not significantly compromise management objectives. Contrast this with using one large stormwater pond—if that one big pond fails, the entire system fails.
7. Prevention, Outreach and Education – All efforts should be made to reduce the introduction of pollutants into the environment. Therefore, a good LID program or project also includes effective public education and outreach to help ensure proper use, handling, disposal of pollutants, and maintenance of LID practices.

The first three of these principles lend themselves to development of specific design standards and are used in *Section 4* of this guidance to organized LID practices.

---

## 2.2 Site Planning and Design Process

The LID approach emphasizes the use of site design and planning techniques to conserve natural systems and hydrologic functions. LID is also a highly engineered design and management strategy, which integrates practices throughout a development.

The simplest and least costly LID technique is good site planning; and an important goal of LID is to mimic the predevelopment hydrology to the extent practicable. To accomplish this, LID projects require a thorough understanding of the site's soils, drainage patterns, and natural features.

Developers should use natural features, hydrology and soils as a design element. In order to minimize the runoff potential an understanding of site drainage patterns and soils can suggest locations both for green areas and potential building sites. Integration of natural features into the site design creates a more ecologically functional site and a more aesthetically pleasing landscape that will be a vital functioning part of the ecosystem. Outlined below is the basic LID site process.

## 2.2.1 Step 1 – Define Basic Project Objectives and Goals

Identifying the project objectives not only includes identifying regulatory needs, but also ecological needs. Ecological needs include these fundamental aspects:

- Runoff volume to match predevelopment.
- Peak runoff rate to meet regulatory needs.
- Flow frequency and duration to match redevelopment.
- Water quality to meet regulatory requirements.
- Stream or wetland base flow needs.
- Recharge areas.
- Natural resource conservation requirements.

To ensure ecological needs receive appropriate attention, the developer should prioritize and rank objectives and determine the type controls required to meet objectives such as infiltration, filtration, discharge frequency, volume of discharges and groundwater recharge. Determine the feasibility for type and proper location of LID controls to best address volume, flows, discharge frequency, discharge duration and water quality.

## 2.2.2 Step 2 – Site Evaluation and Analysis

A site evaluation will facilitate design by providing details that will help to customizing LID techniques for the sites unique constraints, regulatory requirements and receiving water goals.

1. Conduct a detailed investigation of the site using available documents such as drainage maps, utilities information, soils maps, land use plans, and aerial photographs.
2. Evaluate site constraints such as available space, soil infiltration characteristics, water table, slope, rock outcrop, drainage patterns, sunlight and shade, wind, critical habitat, existing buildings, infill opportunities, circulation and underground utilities.
3. Identify protected areas, setbacks, easements, topographic features, sub drainage divides, and other site features that should be protected such as floodplains, steep slopes, and wetlands.



4. Delineate the watershed and micro-watershed areas. Take into account previously modified drainage patterns, roads, infill opportunities, and stormwater conveyance systems.

Many other unique site features may influence the site design including historical features, view sheds, climatic factors, energy conservation, noise, watershed goals, onsite wastewater disposal and off-site flows. All of these factors help to define the development area and natural features to be integrated into the LID design.

### 2.2.3 Step 3 – Optimize Conservation of Natural Features at the Larger Watershed Scale

LID does not promote the use of any particular style site development such as traditional neighborhood design, conventional grid patterns, cluster development, conservation design or new urbanism. Regardless of the development style, LID techniques can always be used throughout the site. The examples to the right (*Figure 2.4*) demonstrate integration of resource conservation into a conventional design. Natural features are saved to reduce impacts and allow for greater use of natural features to treat runoff. Conserving natural features not only reduces impacts but preserves habitat and natural ecological processes to be used for stormwater controls.

The most successful LID design begins with understanding of the site’s natural resources and how best to save these features and incorporate them into the stormwater management system. To the extent practicable and in accordance with current regulations, natural features (wetlands, trees/vegetation, good soils) should be conserved and integrated into the overall site plan. The conservation features should continue to be used by directing runoff to the natural features in the same manner as the predevelopment conditions. The greater use of natural features generally means reduction of clearing and grading and lower cost.

Locating infrastructure to direct runoff to buffers, vegetative filters, existing drainage features will help to reduce runoff quantity and improve water quality. This approach reduces disturbance of the natural soils and vegetation allowing more areas for infiltration and runoff contact with the landscape. To optimize the use of green space requires an ability to lay out the site infrastructure in a way that allows saving sensitive the natural features and their functions. The basic strategy is shown in *Figure 2.4*.

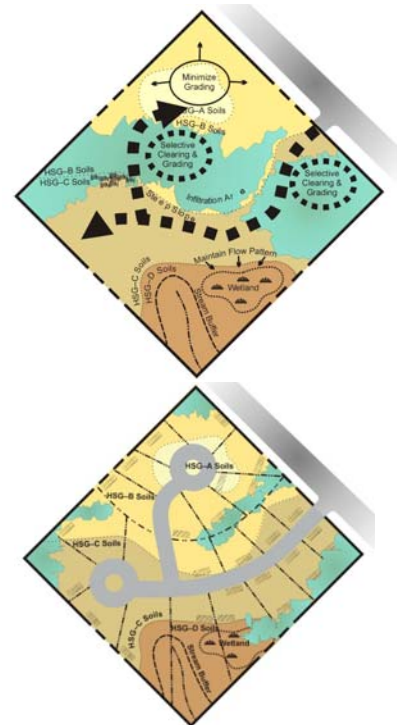

Figure 2.4 – Optimizing the use of green space.

There are many techniques that should be considered including:

- Minimizing and properly stage grading and clearing for roadways and building pads as only necessary.
- Locating, saving and utilizing pervious soils.
- Locating treatment practices in pervious hydrologic soil groups A and B.
- *Where feasible*, constructing impervious surfaces on less pervious hydrologic soil groups C and D.
- Disconnecting impervious surfaces by draining them to natural features.
- Flattening slopes where possible.
- Re-vegetating cleared and graded areas.
- Utilizing existing drainage patterns.
- Routing flow over longer distances.
- Using overland sheet flow.
- Maximizing runoff storage in natural depressions.

## 2.2.4 Step 4 – Minimize Impacts at the Lot Level

To the extent practicable, conserve trees, natural drainage patterns, pervious soils and depressions at the lot level. This often means less clearing and grading. *Figure 2.5* contrasts the conventional approach of draining runoff to the streets vs. a LID design using site fingerprinting where runoff is directed to the natural features.

The key to preventing excessive runoff from being generated is slow down velocities by directing it toward areas where it can be absorbed. The reliance on many small measures used throughout the site will serve this purpose better than a single large control measure.

There are many lot level techniques that should be considered including:

- Avoiding installation of roof drains.
- Directing flows to vegetated areas.
- Directing flows from paved areas to stabilized vegetated areas.
- Breaking up flow directions from large paved surfaces.
- Encouraging sheet flow through vegetated areas.
- Locating impervious areas so that they drain to permeable areas.
- Maximizing overland sheet flow.
- Lengthening flow paths and increase the number of flow paths.
- Maximizing use of open swale systems.

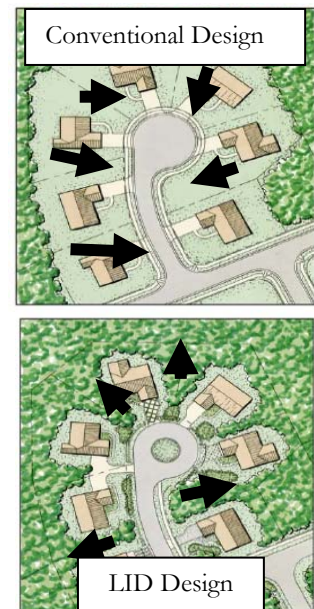

Figure 2.5 – Contrasting runoff patterns in conventional and LID design.



Figure 2.6 – Lot level techniques.



- Increasing (or augmenting) the amount of vegetation on the site.
- Using site fingerprinting. Restricting ground disturbance to the smallest possible area.
- Reducing paving.
- Reducing compaction or disturbance of highly permeable soils.
- Avoiding removal of existing trees.
- Reducing the use of turf and use more natural land cover.
- Maintaining existing topography and drainage divides.
- Locating structures, roadways on Type C soils *where feasible*.<sup>1</sup>

Various lot level techniques are illustrated in *Figure 2.6*.

### 3 Use of Integrated Management Practices in Various Settings

IMPs are those techniques used to treat additional runoff volume needed to meet regulatory needs or receiving water goals that were not obtained during the site planning process. These practices create additional volume storage, detention and filtration opportunities to increase the treatment capacity of the landscape.

IMPs can be applied in a variety of settings. The remainder of this section focuses on the use of IMPs in several specialized settings:

- Low- to medium-density residential settings.
- Commercial, industrial and high-density residential settings.
- Roadways.
- Retrofits and redevelopment.

#### 3.1 Integrated Management Practices in a Residential Setting

In addition to the many possible site planning techniques used, additional treatment can be provided using the following engineered practices listed below. *Figure 3.1* provides a schematic example of a combination of practices. Some potential applications of IMPs are discussed below.

- Bioretention or Rain Gardens – Vegetated depressions that collect

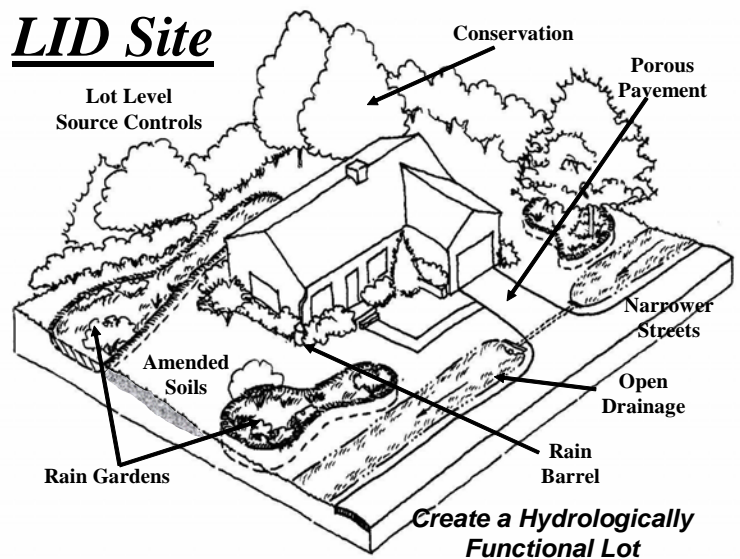

Figure 3.1 – Schematic of engineered practices.

<sup>1</sup> Because Type C and D soils tend to be poorly suited to construction, site structures on them may be ineffective from a cost-benefit standpoint or technically impractical.

runoff and either filter before discharge or infiltrate it into the ground.

- Dry Wells – Gravel- or stone-filled pits that are located to catch water from roof downspouts or paved areas.
- Filter Strips – Bands of dense vegetation planted immediately downstream of a runoff source designed to filter runoff before entering a receiving structure or water body.
- Grass Swales – Shallow channels lined with grass and used to convey and store runoff.
- Infiltration Trenches – Trenches filled with porous media such as bioretention material, sand, or aggregate that collect runoff and exfiltrate it into the ground.
- Permeable Pavement – Asphalt or concrete rendered porous by the aggregate structure.
- Permeable Pavers – Manufactured paving stones containing spaces where water can penetrate into the porous media placed underneath.
- Rain Barrels and Cisterns – Containers of various sizes that store the runoff delivered through building downspouts. Rain barrels are generally smaller structures, located above ground. Cisterns are larger, are often buried underground, and may be connected to the building's plumbing or irrigation system.
- Soil amendments – Minerals and organic material added to soil to increase its capacity for infiltration, absorbing moisture and sustaining vegetation.
- Planter box filters – Curbside containers placed below grade, covered with a grate, filled with filter media and planted with a tree in the center.
- Vegetated Buffers – Natural or man-made vegetated areas adjacent to a waterbody, providing erosion control, filtering capability, and habitat.
- On-lot tree-save areas – Runoff can be directed to existing on-lot tree conservation areas to encourage stormwater retention.
- Small detention features – For example driveway culverts can be undersized to detain flow and encourage stormwater retention.
- Infiltration Swales – Swales designed with infiltration trenches.

### 3.2 Integrated Management Practices for High Density Industrial, Commercial and Residential Development

It is relatively easy to understand how LID principals and practices can be applied to single family residential development where there is ample space. High density development seems much more challenging with little green space available for LID practices. However, there is little difference in the application of LID site design principles nor the use of small scale engineered practices for volume and water quality control. The only difference is LID practices must be designed to accommodate building architecture, sidewalks, parking lots, streets and landscaping.

It is still important to optimize the conservation and use of natural resources and soils on the larger project level and where feasible minimize impacts internal to the site.

The examples shown in *Figure 3.2* provide general LID design strategies for office buildings, small commercial buildings and big box sites. These site designs include a variety of techniques.

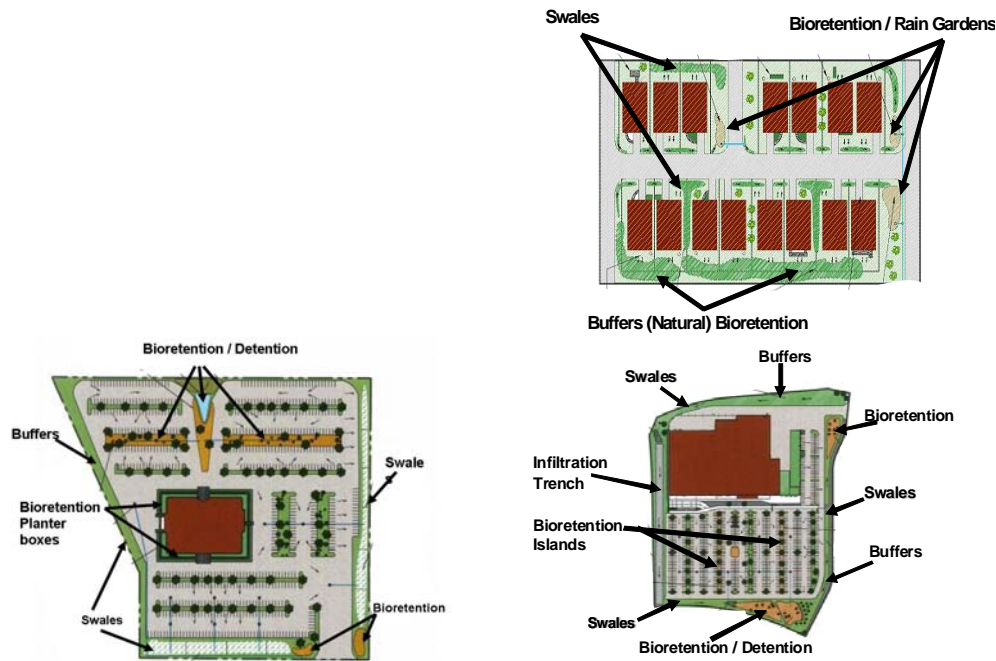
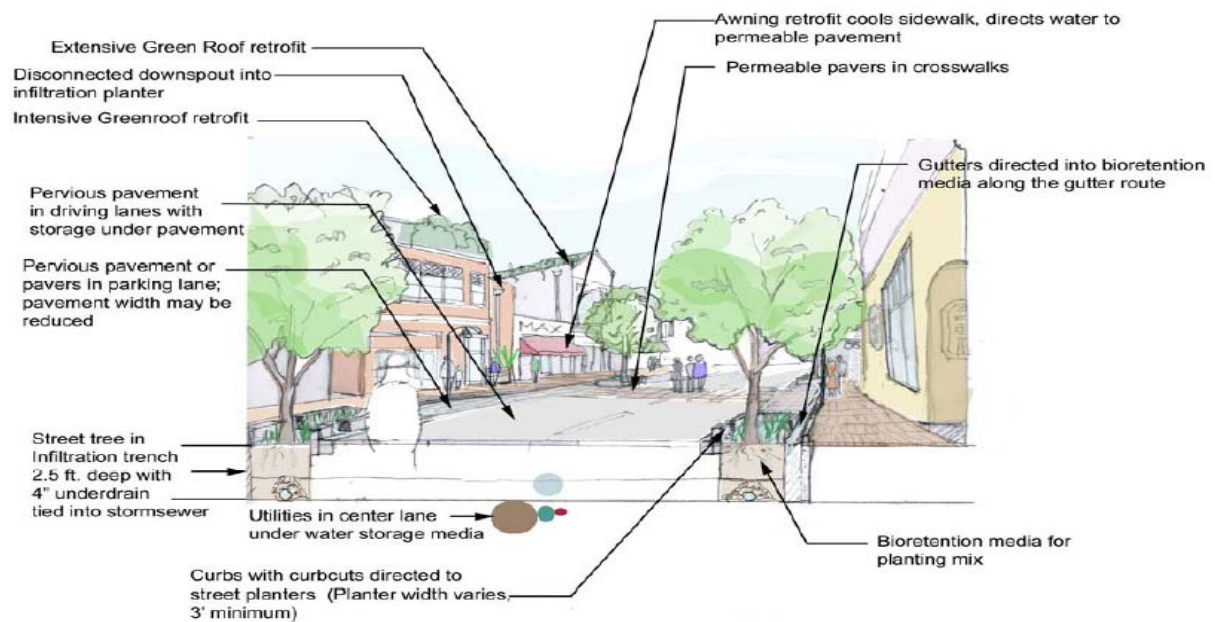

Figure 3.2 – LID design strategies for office buildings, small commercial buildings, and big box sites.

Typical LID techniques used for high-density developments include: perimeter buffers, swales and bioretention systems; parking lot bioretention/detention islands, planter boxes, green roofs, porous pavers/pavement and infiltration devices and underground storage. Runoff can be stored for use or controlled under buildings, parking lots and sidewalks using porous pavers and volume storage devices.

LID techniques can be integrated throughout the available green space using a range of bioretention techniques such as planter boxes, swales and street trees. In addition to the LID techniques previously listed, other engineered practices for high density development are included below. *Figure 3.3* provides a schematic example.

- Planter Boxes – Bioretention systems within containers designed for filtration and or infiltration.
- Green Roofs – Vegetated roofs designed for retention / detention storage and, filtration.
- Underground Storage – Use of cisterns, pipes, vaults or other storage devices for retention or detention storage.
- Porous Pavers and Surfaces – Porous surfaces design in combination gravel storage or other.
- Manufactured Devices – Numerous commercial devices are available for filtration, screening, storage and treatment that can be integrated in the high density development.
- Building Architecture – Buildings can be designed to capture hold and use more runoff with, cisterns, planter boxes and wall planting systems.



**Decentralized Stormwater Controls in Urban Retrofit Streetscape**

Figure 3.3 – Schematic example of engineered practices in an urban retrofit streetscape.

### 3.3 LID Roadway Designs

Roadways generate a major portion of runoff in urban areas and present significant engineering challenges in developing effective LID roadway controls. Despite the challenges there are effective LID design principles and engineering practices available for any roadway system to meet water quality objectives. However, use of some techniques may require modification roadway design standards. Further, in highly urbanized development, site constraints (limited space, poor soils and utility conflicts) often require more extensive engineering and use of more expensive structural LID practices.

A LID roadway design does not require reduction of impervious surface but rather optimizing the integration of LID practices by engineering the roadway itself or the surrounding landscape/streetscape to provide storage, detention or filtration as applicable. Reduction of the roadway surfaces is most useful in creating additional space for the use LID practices. Consider opportunities to hydrologically disconnect roadway surfaces by directing runoff to LID practices for storage, detention or infiltration.

#### 3.3.1 Open Section Roadways

Open section roadways consist of a variable-width gravel or grass shoulder, usually wide enough to accommodate a parked car, and an adjoining grassed swale that conveys and treats runoff. When feasible, reducing road width provides greater opportunities to increase the width of grass shoulders and swales for treatment.

Street pavements width should be adjusted accordingly depending on off-street parking availability and shoulder requirements. Where feasible preserve existing vegetation and drainage features adjacent to the shoulder or swale. Also consider placing utilities under street pavements to eliminate conflicts with tree roots, grassed swales, and bioretention areas.

A primary goal of LID is to work with landscape hydrology and make it more functional (i.e., to use the surrounding landscape to absorb and filter water). *Figure 3.4* shows a 60-foot roadway design with sidewalks on both sides. The important LID feature is the use of wider more functional swales for treatment and control. Notice that the swales are located between the road surface and sidewalks providing greater protection to pedestrians.

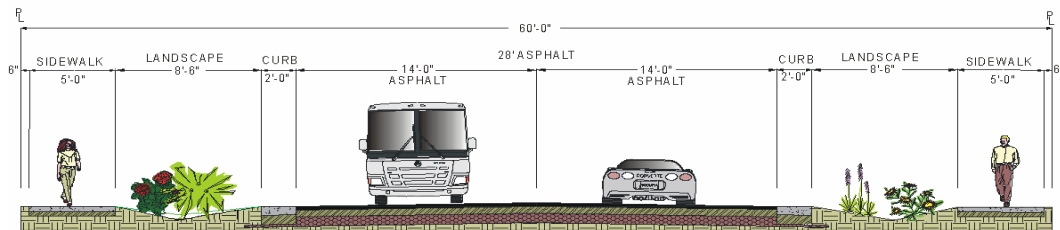

Figure 3.4 – Open section roadways.

The figure below (*Figure 3.5*) shows a narrow road section with sidewalks, shallow swale and porous pavement shoulders. The paver blocks provide a rough surface to alert drivers if their



tires leave the road surface. The pavers also protect the edge of the asphalt surface from breaking off. Generally, very shallow and broad swales are preferred as they provide more surface area to treat and absorb runoff. Swale performance can be greatly enhanced when you can take advantage of infiltration.



Figure 3.5 - Narrow low-volume road section with sidewalks, shallow swale and porous pavement shoulders.

The figure below (*Figure 3.6*) shows an example of how to design a swale to enhance its ability to filter and infiltrate runoff. In this case several features have been incorporated into the design including using the culvert as a weir for detention control; check dams to increase ponding time and decrease velocities; trench drain along the bottom of the swale to encourage infiltration and increase runoff storage in the engineered soil. Road water quality treatment swales should be designed to be shallow with under drains if possible to encourage good drainage and discourage standing water and associated nuisance problems.

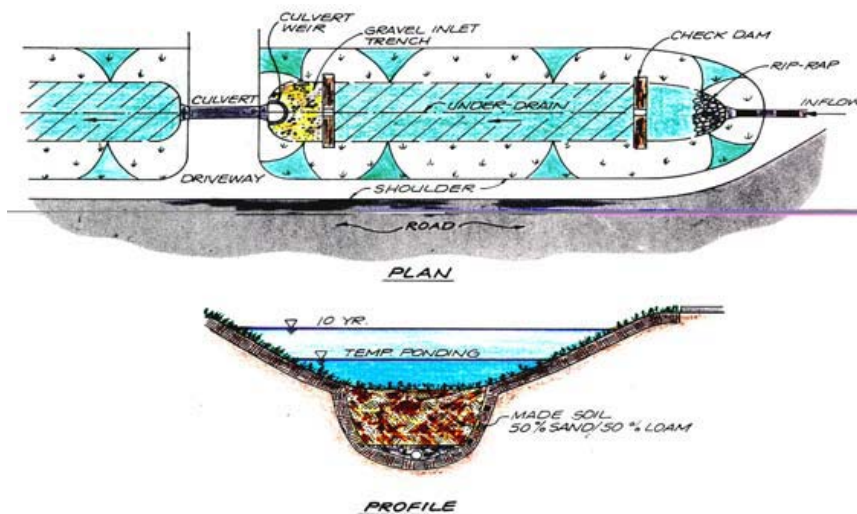

Figure 3.6 - Swale design to enhance its ability to filter and infiltrate runoff.

When it is possible to use narrower roadways the table below (*Table 3.2*) provides suggested general guidance. Even a narrow street width of 22 feet can still accommodate parking on one side of the roadway and leave ample room for a safe travel lane that is generous enough to accommodate most fire trucks, school buses, and garbage trucks.

**Table 3.2  
General Guidance for Narrower Roadways**

Local Streets	
No On-Street Parking	18 feet
Parking on One Side	22 feet
Parking on Both Sides	28 feet

Adapted from *Designing Walkable Urban Thoroughfares (ITE, 2010)*.

Local Streets are intended to provide access to individual lots. They should provide low-speed bicycle and vehicle routes and while accommodating pedestrians. In comparison to other types of streets, local streets should generally be short in total distance.

In residential areas, “yield” local streets provide the preferred cross-section to encourage equal priority among all users. These streets are characterized by a relatively narrow unstriped travelway shared by all vehicles, and also have comfortable pedestrian facilities. “Narrow” local streets may be used where most parking is handled off-street. This is typical in a traditional neighborhood design (TND) context. Where on-street parking is expected to be more heavily used, yield streets may not be appropriate.

Each local street type should feature a 14-foot minimum clear travel path so as to appropriately accommodate emergency vehicles.

### 3.3.2 CUL-DE-SAC Designs

Homebuyers often prefer cul-de-sac properties for many reasons, and thus cul-de-sacs have become quite common. Depending on a subdivision’s lot size and street frontage requirements, five to ten houses can usually be located around a standard cul-de-sac perimeter. The bulb shape allows vehicles up to a certain turning radius to navigate the circle. To allow emergency vehicles to turn around, cul-de-sac radii can vary from as narrow as 30 feet to upwards of 60 feet, with right-of-way widths usually extending ten feet beyond these lengths. *Figure 3.7* shows an open section roadway with on lot bioretention and a cul-de-sac with a bioretention area in the center for roadway runoff.

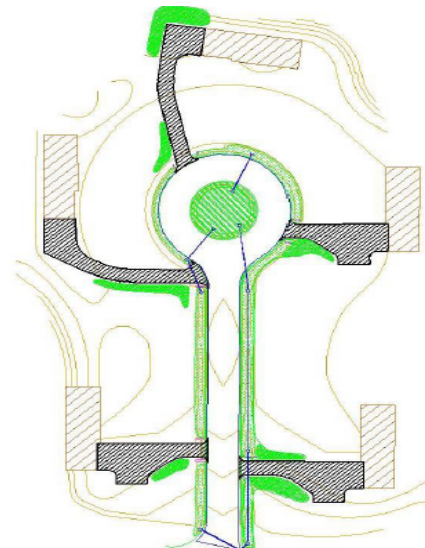

Figure 3.7 – Cul-de-sac designs.



### 3.3.3 Divided Highways

The wider right-of-ways of divided highways provide many opportunities for LID practices on the shoulders and in the median. *Figure 3.8* and *Figure 3.9* provides examples of these options.



Figure 3.8 – Examples of center median infiltration/filtration systems

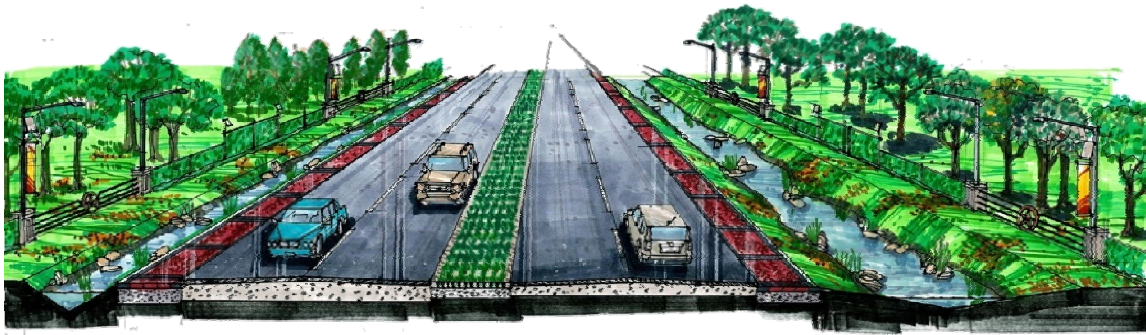

Figure 3.9 - Shoulder Treatment Systems using detention and filtration design.

### 3.3.4 Highly Urbanized LID Street Design

Below are two examples of planter box designs in high density development (*Figure 3.10*). The image on the left is a slow flow system that requires very large surface areas to treat the water quality volume. The image on the right is a very high flow media system that has an extremely small foot print saving space reducing overall construction and maintenance costs. However, both provide the same water quality treatment benefits. Both systems can be designed with underground storage for detention infiltration or retention to be used for irrigation. There are many devices that can be used for underground storage ranging from metal, plastic or concrete pipes to a variety of plastic prefabricated storage devices.



Figure 3.10 – Examples of planter box designs in high density development in Connecticut.

### 3.3.5 Porous Surfaces

Porous pavers, asphalt and concrete are all other design options to provide a hard surface suitable for roadways that allow runoff to percolate into underground gravel beds or other



storage devices for detention or infiltration. An example is provided below as *Figure 3.11*. To reduce the cost these surfaces they should not be placed over the entire roadway but rather strategically placed and sized to allow sufficient runoff volume to enter the underlying storage device.



Figure 3.11 – Porous surfaces

### 3.3.6 Other LID Roadway Design Considerations

- Maximize natural drainage – when planning streets, consider preserving natural drainage patterns and soil permeability by preserve natural drainage patterns and avoid locating streets in low areas or highly permeable soils.
- Uncurbed roads – where feasible, build uncurbed roads using vegetated swales as an alternative.
- Urban curb/swale system – runoff runs along a curb and enters a surface swale via a curb cut, instead of entering a catch basin to the storm drain system.
- Dual drainage system – a pair of catch basins with the first sized to capture the water quality volume into a swale while the second collects the overflow into a storm drain.
- Concave medians – median is depressed below the adjacent pavement and designed to receive runoff by curb inlets or sheet flow. Can be designed as a landscaped swale or a biofilter.
- Street Length – Reduce the length of residential streets by reviewing minimum lot widths and exploring alternative street layouts.
- Access – Consider access for large vehicles, equipment, and emergency vehicles when designing alternative street layouts and widths.

- Right-of-way – should reflect the minimum required to accommodate the travel lane, parking, sidewalk, and vegetation, if present.
- Permeable materials – use in alleys and on-street parking, particularly pull out areas.

---

## 3.4 Urban Retrofit and Redevelopment

The poor state of our surface waters is the direct result of increased runoff volume and pollution loads from existing development. If impaired receiving waters are to be restored the impacts from existing development must be addressed. LID practices allow for retrofit of developed areas by integrating small-scale management techniques into the urban landscape (roads, sidewalks, parking areas, buildings, etc.). In most cases existing landscape features can simply be converted into bioretention systems for filtration, detention and infiltration. In more difficult cases storage can be provided under sidewalks and parking lots or on rooftops.

The most economical way to retrofit existing development is to ensure that all infill development, redevelopment and reconstruction projects include the LID practices. Over time as urban areas are redeveloped and rebuilt with LID practices much of the urban runoff can be treated greatly reducing water quality impacts and reducing flooding potential. The City of Portland, OR has evaluated such an urban retrofit program and has found over a 50-year period much of the City's runoff can be controlled and treated by green roofs and bioretention streetscape systems for roadway and parking lot runoff.

When selecting the most appropriate retrofit techniques it is important to select LID practices that can best address receiving water quality and volume needs. For example, where receiving waters are impaired by heavy metals or bacteria bioretention filtration and/or infiltration techniques would be most appropriate. Where volume control is necessary for detention porous surfaces or filtration devices in combination with underground storage detention and/or infiltration practices are best.

### 3.4.1 Retrofit Case Studies

Retrofit and redevelopment projects utilizing LID techniques have been implemented throughout the country in recent years. Multiple projects have occurred in Connecticut. For example, a traffic control project calling for access management adjacent to North Main Street in the City of Bridgeport, CT, incorporated rain gardens/bioretention and permeable pavement into project design. Specifically, North Main Street was narrowed and permeable pavement was installed alongside portions of the roadway to accommodate vehicular parking and treat storm water runoff. Additionally, series of rain gardens were installed along the sidewalk to receive and treat storm water runoff. Photographs of the LID techniques implemented along Main Street are provided as *Figure 3.12*.



Figure 3.12 – Permeable pavement (left photograph) and rain garden/bioretention (right photograph) retrofits along North Main Street in Bridgeport, CT.

Another example of green infrastructure retrofit project is the Hartford Green Capitols project. This project focused on Connecticut’s capitol building in Harford, CT and included installation of porous pavement, green roofs, and rain gardens, as well as rain harvesting techniques. Such techniques served to improve water quality and educate state residents about green infrastructure. Photographs of the LID techniques implemented as part of the Hartford Green Capitols Project are provided as *Figures 3.13-3.15*.



Figure 3.13 – Bioretention retrofit.



Figure 3.14 – Construction of a rain garden at Hartford Green Capitols Project. Source: Camp Dresser & McKee.





Figure 3.15 – Permeable pavement at Hartford Green Capitols Project. Source: Camp Dresser & McKee.

Additional examples of techniques used in Connecticut for both retrofit and redevelopment projects are provided as *Figure 3.16*.



Bioretention area at University of Connecticut Storrs Campus.



Roads are narrowed and permeable pavement is installed along roadways to provide additional parking and treat runoff.



Figure 3.16 – Retrofit and redevelopment techniques in Connecticut. Source: Connecticut Department of Environmental Protection.

## 4 Design Standards for Low Impact Development Controls

This section discusses design standards for LID controls. It provides a general description of each control, its advantages, general use, and standards for its application. These standards are intended to elaborate on the narrative description of LID best management practices provided in chapter 4 of the *Connecticut Stormwater Quality Manual*.

- Approaches that Optimize Conservation
  - Limits of Clearing and Grading
  - Preserving Natural Areas
  - Avoid Disturbing Long, Steep Slopes
  - Minimize Siting on Porous and Erodible Soils
- Approaches that Mimic Natural Water Balance
- Approaches that Minimize and Disconnect Impervious Surface
  - Roadways
  - Buildings
  - Parking Footprints
  - Parking Lot Islands
  - Permeable Pavement
  - Disconnecting Impervious Area
- Integrated Management Practices at the Source
  - Vegetated Filter Strips
  - Natural Drainage Ways
  - Green Roofs and Façade
  - Rain Barrels and Cisterns
  - Dry Wells
  - Bioretention and Rain Gardens
  - Infiltration

---

### 4.1 Approaches that Optimize Conservation

#### 4.1.1 Limits of Clearing and Grading

Perhaps the most potentially destructive stage in land development is the preparation of a site for building—clearing of vegetation and soil grading (Schueler, 1995). The limits of clearing and grading refer to the part of the site where development will occur. This includes all impervious areas such as roads, sidewalks, rooftops, as well as areas such as lawn and open drainage systems.

To minimize impacts, the area of development should be located in the least sensitive areas available. At a minimum, developers should avoid streams, floodplains, wetlands, and steep slopes. Where practicable, developers should also avoid soils with high infiltration rates as these will aid in reducing runoff volumes.



## Advantages

- Preserves more undisturbed natural areas on a development site.
- Uses techniques to help protect natural conservation areas and other site features.
- Promotes evapotranspiration and infiltration to reduce need for treatment and peak volume control at end-of-pipe.
- Reduces generation of stormwater.
- Helps to demonstrate compliance with regulatory standards (e.g., freshwater wetlands, coastal resources, water quality, wildlife, local environmental protection, etc.) for avoidance and minimization as well as setbacks from sensitive features.
- Maintains predevelopment hydrology, natural character and aesthetic features that may increase market value.
- Promotes stable soils.
- May reduce landscaping costs.

## Use

Establishing a limit of disturbance based on maximum disturbance zone radii/lengths. These maximum distances should reflect reasonable construction techniques and equipment needs together with the physical situation of the development site such as slopes or soils. Limits of disturbance may vary by type of development, size of lot or site, and by the specific development feature involved.

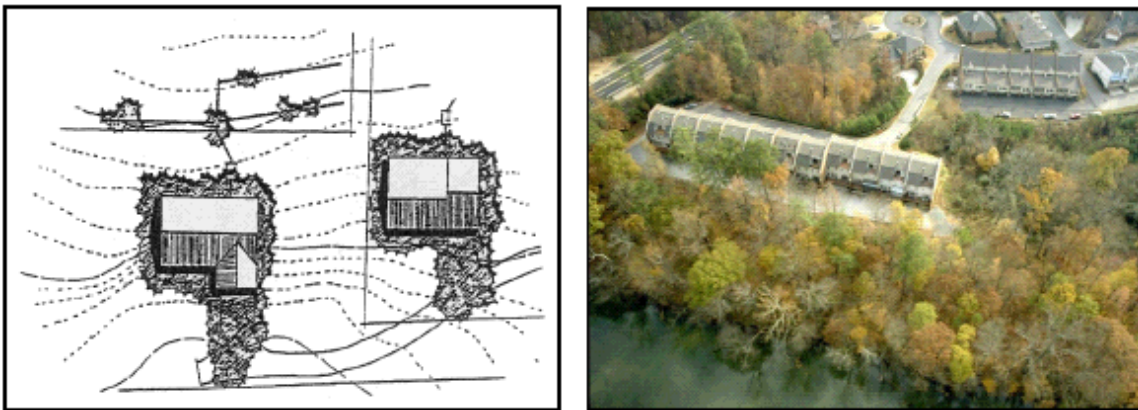

Figure 4.1 - Reduced limits of disturbance minimize water quality impacts. Source: Atlanta Regional Commission, 2001.

## Standards

Generally speaking, limits of disturbance need not comprise more than:

- a) Area of the building pad and utilities (e.g., onsite wastewater treatment systems and wells) plus 25 feet.
- b) Area of a roadbed and shoulder plus 9 feet. (This is not intended to limit lawn areas.)

## 4.1.2 Preserving Natural Areas

Natural areas include woodlands, riparian corridors, areas contiguous to wetlands and other hydrologically sensitive and naturally vegetated areas. To the extent practicable these areas should be preserved.

Natural areas can be one of the most important components within a development scheme, not only from a stormwater management perspective, but in reducing noise pollution and providing valuable wildlife habitat and scenic values. New development tends to fragment large tracts of undisturbed areas and displace plant and animal species; therefore it is essential to maintain these buffers in order to minimize impacts. Areas adjacent to waterbodies (both freshwater and coastal) are protected under state law and cannot be altered without a state agency permit.

### Advantages

- Promotes evapotranspiration and infiltration to reduce need for treatment and peak volume control at end-of-pipe.
- Reduces generation of stormwater.
- Helps to demonstrate compliance with regulatory standards (e.g., freshwater wetlands, coastal resources, water quality, wildlife, local environmental protection, etc.) for avoidance and minimization as well as setbacks from sensitive features.
- Reduces safety and property-damage risks where flood hazard areas are incorporated into preservation.
- Maintains predevelopment hydrology, natural character and aesthetic features that may increase market value.
- Promotes stable soils.
- Establishes and maintains open space corridors.

### Use

- a) Check all federal, state and local enforceable policy to ensure proper setbacks and identification of preservation areas. Identify areas for preservation through site analysis using maps and aerial or satellite photography or by conducting a site visit.
- b) Delineate areas for preservation via limits of disturbance before any clearing or construction begins and should be used to set the development envelope as well as guide site layout. Clearly mark areas for preservation on all construction and grading plans to ensure that equipment is kept out of these areas and that native vegetation is kept in an undisturbed state.
- c) Protect preservation areas in perpetuity by legally enforceable deed restrictions, conservation easements and maintenance agreements.

Figure 4.2 shows a site map with undisturbed natural areas delineated.

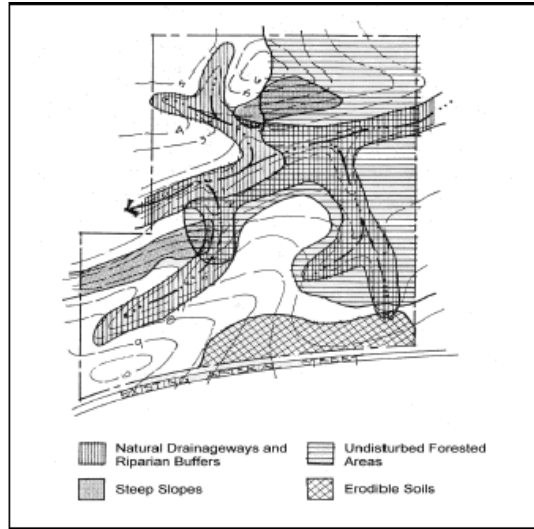

Figure 4.2 – Site map with natural areas delineated. Source: Atlanta Regional Commission, 2001.

## Special Considerations

### *Riparian Buffers*

A riparian buffer is a special type of preserved area along a watercourse where development is restricted or prohibited. Buffers protect and physically separate a watercourse from development. Riparian buffers also provide stormwater control flood storage and habitat values. An example of a riparian buffer is shown in *Figure 4.3*. Wherever possible, riparian buffers should be sized to include the 100-year floodplain as well as steep banks and freshwater wetlands.



Figure 4.3 – Riparian buffer along the French River, in Thompson, CT. Source: Connecticut Department of Environmental Protection.

Riparian buffers consist of three zones (see *Figure 4.4*):

- The inner zone consists of the jurisdictional riverbank wetland and should be sized accordingly. In addition to runoff protection, this zone provides bank stabilization as well as shading and protection for the stream. This zone should also include wetlands and any critical habitats, and its width should be adjusted accordingly. Permits should be sought for activities in the inner zone. Generally speaking, structural best management practices (BMPs) are not allowed in the inner zone.

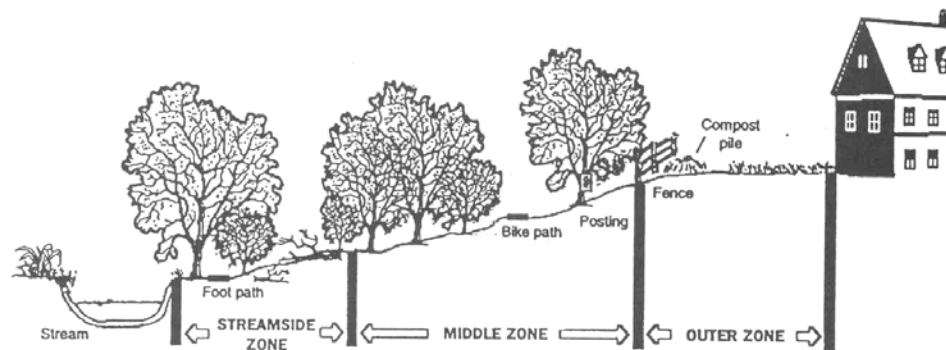

Figure 4.4 – Three-zone riparian buffer. Source: Atlanta Regional Commission, 2001.

- The middle zone provides a transition between upland development and the inner zone and should consist of managed woodland that allows for infiltration and filtration of runoff. A 25-foot width is recommended for this zone at a minimum. Forested riparian buffers should be maintained and reforestation should be encouraged where no wooded buffer exists. Proper restoration should include all layers of the forest plant community, including understory, shrubs and groundcover, not just trees.
- An outer zone allows more clearing and acts as a further setback for impervious surfaces. It also functions to prevent encroachment and filter runoff. A 25-foot width is recommended for this zone.

Ideally, all three zones of the riparian buffer should remain in their natural state. However, some maintenance is periodically necessary, such as planting to minimize concentrated flow, the removal of exotic plant species when these species are detrimental to the vegetated buffer and the removal of diseased or damaged trees.

## Floodplains

Floodplains are the low-lying flatlands that border streams and rivers. When a stream reaches its capacity and overflows its channel after storm events, the floodplain provides for storage and conveyance of these excess flows. In their natural state they reduce flood velocities and peak flow rates by the passage of flows through dense vegetation. Floodplains also play an important role in reducing sedimentation and filtering runoff, and provide habitat for both aquatic and terrestrial life. Development in floodplain areas can reduce the ability of the floodplain to convey stormwater, potentially causing safety problems or significant damage to the site in question, as well as to both upstream and downstream properties.

As such, floodplain areas should be avoided on a development site. Ideally, the entire 100-year floodplain at full buildout should be avoided for clearing or building activities, and should be preserved in a natural undisturbed state where possible. Maps of the 100-year floodplain can typically be obtained through the local review authority.

## Standards

### General

- a) No disturbance shall occur to preservation areas during project construction.
- b) Preserved areas shall be protected by limits of disturbance clearly shown on all construction drawings and clearly marked on site.
- c) Preservation areas shall be located within an acceptable conservation easement instrument that ensures perpetual protection of the proposed area. The easement must clearly specify how the natural area vegetation shall be managed and boundaries will be marked. [Note: managed turf (e.g., playgrounds, regularly maintained open areas) is not an acceptable form of vegetation management.]
- d) Preservation areas shall have a minimum contiguous area of 10,000 square feet or in the case of stream buffers must maintain a 50-foot set back from the jurisdictional wetland edge along the entire length of stream through the property of concern. Areas of smaller size may be incorporated for disconnection of impervious surface, but will be considered as open space in good condition.
- e) Incorporate level spreaders or other dispersion devices, where practicable, to ensure sheet flow. See *Figure 4.5*, which depicts a level spreader. (Please note that the level spreader shown here is for dispersion of low flows only.)

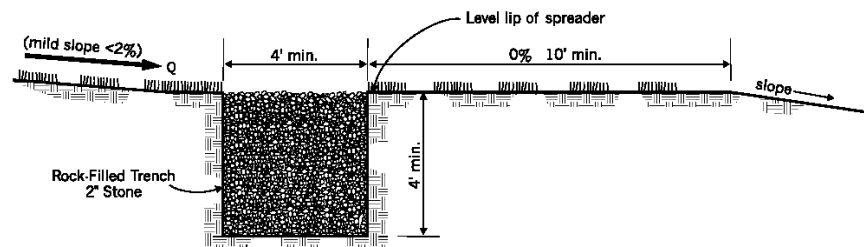

Figure 4.5 – Rock trench level spreader for low flows. Source: Prince George’s County, Maryland, 2000.

- f) Include bypass mechanisms for higher flow events to prevent erosion or damage to a buffer or undisturbed natural area.
- g) Consider incorporating constructed berms around natural depressions and below undisturbed vegetated areas to provide for additional runoff storage and infiltration. Proper use of berms is discussed in the section entitled vegetated filter strips.
- h) Where no berms are provided in Hydrologic Soil Group (HSG) type A and B soils, buffers may be used to attenuate and treat flows up to the water quality volume (i.e., volume equal to one inch over the impervious surface) in the following ratios:

**Table 4.1**  
**Ratio of Forested Buffer to Impervious Surface Required to Attenuate Runoff**  
**for Precipitation between 0.5 and 1.0 Inches<sup>a, b</sup>**

<b>HSG Soil Type</b>				
<b>Runoff (inches)</b>	<b>A</b>	<b>B</b>	<b>C</b>	<b>D</b>
1.0	1:3	2:1	N/A	N/A
0.9	1:4	1:1	N/A	N/A
0.8	1:6	2:3	N/A	N/A
0.7	1:9	2:5	N/A	N/A
0.6	1:15	1:4	1:1	N/A
0.5	1:25	1:8	1:2	N/A

Notes:

<sup>a</sup>Buffer size calculations based on TR-55. Calculations for precipitation depths less than 0.5 inches are not included as the empirical equations of TR-55 become less accurate for storms less than 0.5 inches.

<sup>b</sup>Standards for buffer width, area and length of contributing flow path, etc. must be met regardless of soil's capacity to attenuate flow.

- i) Land cover in buffers will be assumed to be woods in good condition (i.e., Curve number (CN) equal to 32 in type A soil and 55 in type B soil). Type C and D may not be used for this purpose as woods on these soil types cannot abstract the depth of rainfall associated with one inch of runoff from the impervious surface.
- j) Runoff must enter the buffer as overland sheet flow. The average contributing slope should be no less than 1% and no more 3%. Maximum average slope may be increased to 5% if a flow spreader is installed across the entire contributing length followed by a flat (i.e., 0% slope) 10-foot shelf across the length.

*Streambank Areas*

- a) The minimum undisturbed buffer width should be at least the wetland jurisdictional setback plus 50 feet.



### *Maintenance*

Except for routine debris removal, buffers shall remain in a natural and unmanaged condition.

---

## 4.2 Approaches that Mimic Natural Water Balance

LID controls mimic natural predevelopment hydrology in order to retain and attenuate stormwater runoff in upland areas. This reduces the amount of stormwater and intensity of flow at points of discharge. Flow attenuation prevents physical damage to waterways and reduces nonpoint source pollution. The remainder of *Section 4.2* discusses mimic natural water balance as a LID control.

### Advantages

- Decreased need for constructed BMPs.
- Maintain predevelopment hydrology and thus reduces generation of stormwater and associated pollution.
- Encourage groundwater recharge.

### Use

Mimicking predevelopment site hydrology involves a process of comparing and evaluating pre- and postdevelopment conditions that takes place in all stages of site planning. There are many methods of hydrologic analysis. This section of the manual relies on the use of the USDA-SCS Technical Release-55 (TR-55), entitled *Urban Hydrology for Small Watersheds* (1986).

#### *Time of Concentration and Time of Travel*

TR-55 focuses on the time of concentration ( $T_c$ ) as a primary influence in the shape and peak of runoff hydrographs. TR-55 defines time of concentration as the "time for runoff to travel from the hydraulically most distant point of the watershed to a point of interest within the watershed."

$T_c$  is calculated as follows:

$$T_c = T_t(1) + T_t(2) + \dots T_t(m)$$

Where:

$T_t$  (travel time) = time it takes runoff to move across a segment of the watershed.

$m$  = total number of travel segments in a watershed

$T_t$  is mathematically defined by TR-55 as being directly influenced by two factors velocity of runoff ( $V$ ) and length of runoff flow path ( $L$ ). Velocity is further defined as a function of slope ( $s$ ) and surface roughness (i.e., Manning's roughness coefficient for sheet flow) ( $n$ ).



Tt is calculated as follows:

$$T_t = \frac{L}{3600 V}$$

Where:

Tt = travel time in hours  
 L = flow length in feet  
 V = average velocity in feet per second  
 3600 = conversion factor for seconds to hours

*Total Volume and Peak Discharge*

TR-55 also notes that total runoff volume (Q) and peak runoff discharge (qp) tend to increase as a result of urbanization. Peak discharge is defined as a factor of Q and can be calculated using as follows:

$$q_p = q_u A_m Q F_p$$

Where:

qp = peak discharge in cubic feet per second  
 qu = unit peak discharge  
 Am = drainage area in square miles  
 Q = runoff in inches  
 Fp = pond and swamp adjustment factor

Q is derived as a factor of initial abstraction (Ia) and retention (S) and is calculated as follows:

$$Q = \frac{(P - I_a)^2}{(P - I_a) + S}$$

Where:

Q = runoff in inches  
 P = rainfall in inches  
 S = retention  
 Ia = initial abstraction

Initial abstraction is a measure of rainfall held in surface depressions, interception by vegetation, evapotranspiration and infiltration prior to the occurrence of runoff and is calculated as follows:

$$I_a = 0.02 S$$

Where:

Ia = initial abstraction  
 S = retention

Retention is a measure of total capacity for rainwater storage in a watershed during a rain event. In small agricultural watersheds retention is typically about 5 times greater than initial abstraction.

Retention is calculated as follows:

$$S = \frac{1000}{CN} - 10$$

Where:

S = retention

CN = curve number

Curve number is a coefficient ranging from 0 - 100, which is used to represent the conversion of rainfall to runoff. For example, an impervious surface such as concrete has a CN of 98, which is analogous to representing that 98% of rain that falls on concrete runs off.

*Identifying Hydrologic Benefits*

All nonstructural and distributed BMPs have one or more hydrologic benefits in relationship to TR-55. *Table 4.2* summarizes key hydrologic benefits of nonstructural and distributed BMPs recommended in this manual.

**Table 4.2  
Hydrologic Benefits of  
Nonstructural and Distributed Techniques and Controls**

<b>Techniques &amp; Controls</b>	<b>Decrease Curve Number</b>	<b>Reduce Slope</b>	<b>Lengthen Flow Path</b>	<b>Increase Roughness</b>	<b>Increase Initial Abstraction</b>	<b>Increase Total Retention</b>
Reduce Limits of Clearing and Grading	● <sup>a</sup>		● <sup>b</sup>	●	●	
Preserve Natural Features	●		●	●	●	
Avoid Long, Steep Slopes		●	●		●	
Avoid Erodible Soils				●	●	
Avoid Porous Soils	●			●	●	
Minimize Roadways	●		●	●	●	
Minimize Buildings	●		●	●	●	
Minimize Parking	●		●	●	●	
Disconnect Impervious Area	●		●	●	●	
Buffers and Undisturbed Areas	●		●	●	●	●

Techniques & Controls	Decrease Curve Number	Reduce Slope	Lengthen Flow Path	Increase Roughness	Increase Initial Abstraction	Increase Total Retention
Infiltration Swales	●	◐	◐	●	●	●
Vegetative Filter Strips	●			●	●	●
Bioretention	●				●	●
Nonstructural Conveyances	●		◐	●	●	
Drain Rooftop Runoff to Pervious Areas			●	●	●	
Rain Barrels and Cisterns					●	●
Dry Wells					●	●
Green Roofs and Walls					●	●

Notes

<sup>a</sup> Benefit always occurs.

<sup>b</sup> Benefit occurs sometimes.

## Standards

### *Time of Concentration*

The postdevelopment time of concentration ( $T_c$ ) should approximate the predevelopment  $T_c$ .

### *Travel Time*

The travel time ( $T_t$ ) throughout individual lots and areas should be approximately constant.

### *Flow Velocity*

Flow velocity in areas that are graded to natural drainage patterns should be kept as low as possible to avoid soil erosion.

Flows can be disbursed by installing a level spreader along the upland ledge of the natural drainage way buffer, and creating a flat grassy area about 30 feet wide on the upland side of the buffer where runoff can spread out. This grassy area can be incorporated into the buffer itself.



Figure 4.6– Alternative roadway design in Waterford, CT. Source: Tom Walsh, Shoreline Aerial Photography

## 4.3 Approaches to Minimizing and Disconnecting Impervious Surface

A key concept of LID is the minimization and disconnection of impervious surface. For the purposes of stormwater management, impervious surfaces are commonly considered to include roads, parking lots, and buildings.

### 4.3.1 Roadways

The greatest share of impervious cover in most communities is from paved surface such as roads and sidewalks. Roadway lengths and widths should be minimized on a development site where possible to reduce overall impervious surface.

Numerous alternatives create less impervious cover than the traditional 40-foot cul-de-sac. These alternatives include reducing cul-de-sacs to a 30-foot radius and creating hammerheads, loop roads, and pervious islands in the cul-de-sac center (see *Figures 4.7 through 4.9*).

#### Advantages

- Reduces the amount of impervious cover and associated runoff and pollutants generated.
- Reduces the costs associated with road construction and maintenance.

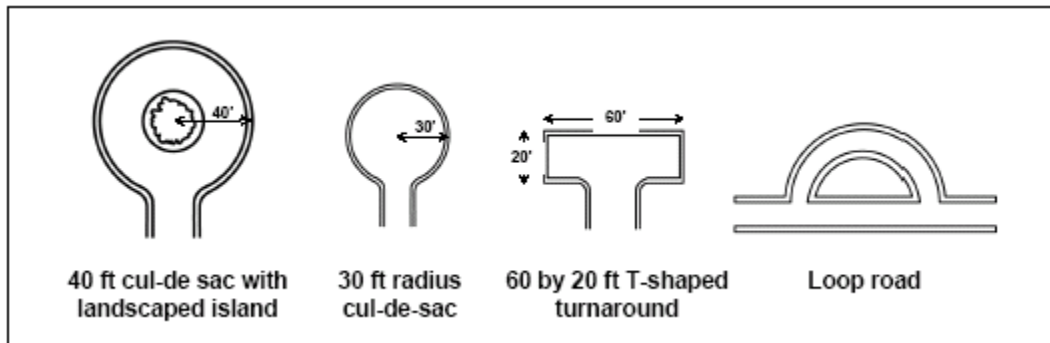

Figure 4.7 – Different styles of turnarounds. Source: Adapted from Atlanta Regional Commission, 2001.



Figure 4.8 – Cul-de-sac infiltration island accepts stormwater from surrounding pavement. Note flat curb. Source: Connecticut, 2004.

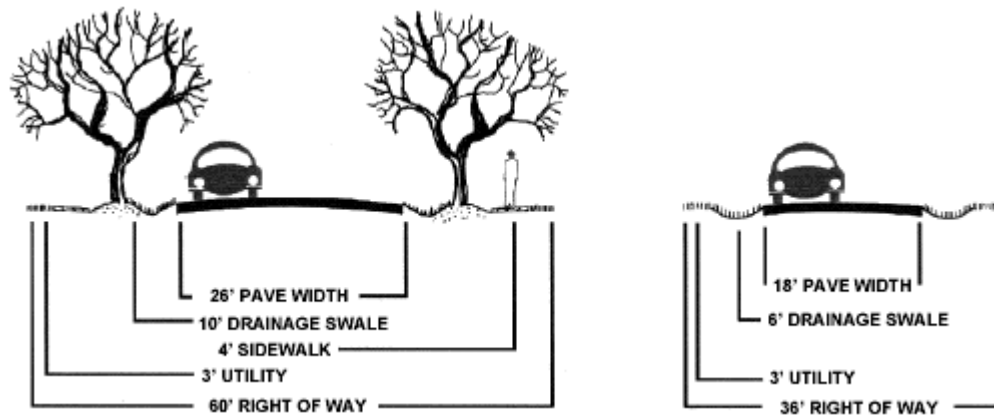

Figure 4.9 – Reduced road widths. Source: Atlanta Regional Commission, 2001.

## Use

Examine local ordinances and other requirements to determine standards and degree of flexibility available. Communities may have specific standards for setbacks and frontages or criteria for cul-de-sacs and other alternative turnarounds.

### *Reduce Roadway Lengths and Widths*

1. Consider site and road layouts that reduce overall street length.
2. Minimize street width by using narrower street designs as appropriate. Issues to consider include design speed, number of average daily trips (ADT), peak usage, need for on-street parking, sidewalks, design speed and right of way (see *Table 4.3*).

### *Reduce Surface Area of End-of-Street Turnarounds*

1. Consider types of vehicles that may need to access a street. Sufficient turnaround area is a significant factor to consider in the design of cul-de-sacs. Fire trucks, service vehicles and school buses are often cited as needing large turning radii. However, some fire trucks are designed for smaller turning radii. In addition, many newer large service vehicles are designed with a tri-axle (requiring a smaller turning radius) and school buses usually do not enter individual cul-de-sacs.
2. Minimize pavement at end-of-street turnarounds. Incorporate landscaped areas and consider alternatives to cul-de-sacs wherever practicable.

## Standards

### *Reduce Roadway Lengths and Widths*

The table below shows a recommended standard for five categories of street. Streets are categorized based on ADT and density of dwelling units (row 1 in the table).



**Table 4.3  
Roadway Design Standards for Five Street Types**

<b>Design Factor</b>	<b>Access</b>	<b>Local</b>	<b>Collector</b>	<b>Arterial</b>
<b>ADT</b>	0 – 500	500 – 5,000	2,500 – 10,000	7,500 – 20,000+
<b>Number of Lanes</b>	2	2	2	2 – 4
<b>Turn lanes</b>	None	None	Left (when needed)	Left and Right (when needed)
<b>Lane Width (feet)</b>	9 – 10	10 – 11	10 – 12	11 – 12
<b>On-Street Parking (feet)</b>	None	7 (parallel)	8 (parallel) 16 – 18 (angle)	None except for CBD
<b>Drainage</b>	Swale or curb/gutter	Swale or curb/gutter	Swale or curb/gutter	Swale or curb/gutter
<b>Target Speed (MPH)</b>	15 – 20	25	25 – 35	30 – 45
<b>Bicycle Lanes</b>	None	Shared	Shared or separate	Yes
<b>Sidewalks</b>	None or one-side	Two side	Two side	One side
<b>Frontage Lots</b>	Yes (may be rear)	Yes	Yes	Some

Average Daily Trips

$$\text{ADT} = 10 \times \text{Number of Dwelling Units} \quad [7]$$

Peak Trips Per Hour

$$\text{Peak Trips/Hour} = \text{Number of Dwelling Units} \quad [8]$$

Please note that local zoning may supersede these recommendations. Although, these recommended standards are intended to account for safety and snow disposal, greater widths may be appropriate in some instances.

*Reduce Surface Area of End-of-Street Turnarounds*

Where cul-de-sacs are necessary radii should be no more than 30 feet. Alternatives such as hammerheads, jug handles and donuts should also be considered.

### 4.3.2 Buildings

Imperviousness associated with buildings and accessories such as driveways can often be reduced with considerate planning in the early stages of site design. The techniques below should be considered and applied wherever practicable.

**Advantages**

- Reduces the amount of impervious cover and associated runoff and pollutants generated.

## Discussion

### *Footprints*

The building footprint is the surface area of ground covered by structure. The impervious footprint of commercial buildings and residences can be reduced by using multistory buildings. In comparison to single-story buildings, multistory buildings maintain floor area while covering less ground surface. Use alternate or taller building designs to reduce the impervious footprint of buildings. For example, in residential areas, consider colonial style homes instead of ranches.

### *Setbacks and Frontages*

Driveways generally extend from a roadway to a house. Therefore, driveway length is typically determined by building setback requirements. Driveways are noted to contribute up to 30 percent of impervious cover in residential areas (Schueler, 1995). Setback requirements of up to 75 feet are not uncommon. Notwithstanding, a driveway length of 20 to 30 feet is generally adequate to meet parking needs. A driveway width of 18 feet is generally adequate for parking two cars side-by-side.

Further, reducing side-yard widths and using narrower frontages can reduce total street length, especially important in cluster and open space designs. *Figure 4.10* shows residential examples of reduced front and side yard setbacks and narrow frontages.



Figure 4.10 – Reduced side yards and frontage at a development in Connecticut.

Flexible lot shapes and setback and frontage distances allow site designers to create attractive and unique lots that provide homeowners with enough space while allowing for the preservation of natural areas in a residential subdivision. *Figure 4.11* illustrates various nontraditional lot designs.

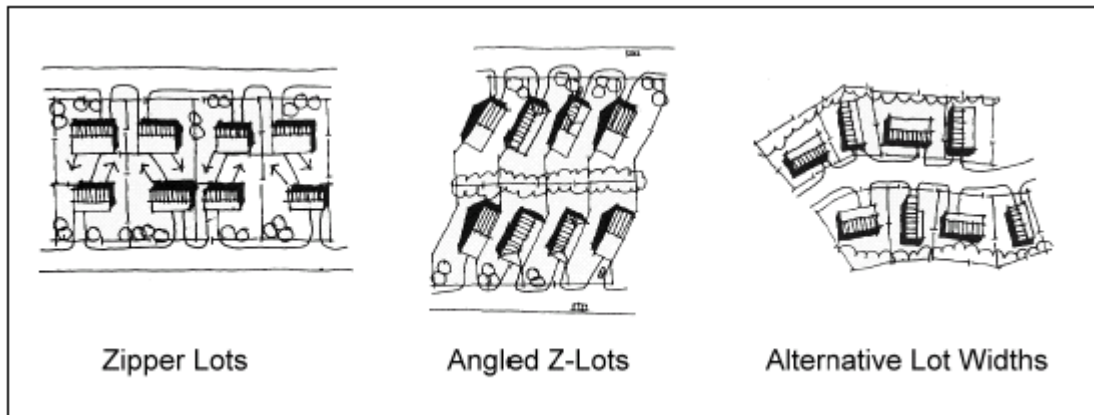

Figure 4.11 – Examples of nontraditional lot designs. Source: Adapted from Atlanta Regional Commission, 2001.

### Use

Use smaller front and side setbacks and narrower frontages to reduce total road length and driveway lengths.

Reduce building and home front and side setbacks to allow for narrow frontages. Consider narrower frontages.

- a) Consider alternative build styles that reduce ratio of footprint to floor area.
- b) Review local regulations. Communities may have specific design criteria for setbacks and frontages.
- c) Minimize setbacks and lot frontages.

### Standards

- a) Where practicable, reduce building setbacks to 20 - 30 feet and driveway widths to 18 feet.
- b) Where practicable, reduce frontages to 60 feet.

### 4.3.3 Parking Footprints

Setting maximums for parking spaces, minimizing stall dimensions, using structured parking and encouraging shared parking and using alternative porous surfaces can reduce the overall parking footprint and site imperviousness.

### Advantages

- Reduces the amount of impervious cover and associated runoff and pollutants generated.

## Use and Standards

Apply the following approach:

Examine local ordinances and other requirements to determine standards and degree of flexibility available. Communities may have specific standards for parking stall size and number of parking spaces. There may also be prohibitions against shared parking.

### *Use Average Demand to Size Lots*

- a) Many parking lot designs result in far more spaces than actually required. This problem is exacerbated by a common practice of setting parking ratios to accommodate the highest hourly parking during the peak season. By determining average parking demand instead, a lower maximum number of parking spaces can be set to accommodate most of the demand.
- b) If no local standards require a minimum number of spaces, apply the standards in *Table 4.4* as a maximum number of spaces.

**Table 4.4**  
**Recommended Maximum Number of Parking Spaces for Certain Land Uses**

Land Use	Maximum Parking Spaces
Single Family House	2 per DU <sup>a</sup>
Shopping Center	5 per 1000 ft <sup>2</sup> GFA <sup>b</sup>
Convenience Store	3.3 per 1000 ft <sup>2</sup> GFA
Industrial	1 per 1000 ft <sup>2</sup> GFA
Medical Dental	5.7 per 1000 ft <sup>2</sup> GFA

Source: Georgia Stormwater Manual, 2002.

Notes:

<sup>a</sup> DU means dwelling unit.

<sup>b</sup> GFA means gross floor area.

### *Minimize Parking Stall Size*

Another technique to reduce the parking footprint is to minimize the dimensions of the parking spaces. This can be accomplished by reducing both the length and width of the parking stall.

Parking stall dimensions can be further reduced if compact spaces are provided. While the trend toward larger sport utility vehicles (SUVs) is often cited as a barrier, stall width requirements in most local parking codes are much larger than the widest SUVs.



Figure 4.12 – Parking deck – New Haven,

*Use Parking Decks*

Structured parking decks can significantly reduce the overall parking footprint by minimizing surface parking. *Figure 4.12* shows a parking deck used for a commercial development.

*Encourage Shared Parking*

Shared parking in mixed-use areas and structured parking are techniques that can further reduce the conversion of land to impervious cover. For developments and blocks with a mix of land uses, perform a shared parking analysis in order to determine the peak demand for spaces for all uses rather than calculating each separately. Often mixed uses may be complimentary with regards to parking. For example, the peak demand for office buildings occurs during the period of minimal demand for residential buildings. The Urban Land Institute publication *Shared Parking*, Second Edition, 2005 provides a detailed methodology in order to determine the peak hour of parking demand and the overall number of spaces required for a mixed use development. This may reduce the number of spaces required by up to 20 percent.

### 4.3.4 Parking Lot Islands

A parking lot island is an area within a parking lot that includes one or more management practices and breaks up impervious surface (see *Figure 4.13*). Parking lot islands include small-scale management practices such as filter strips, dry swales, sand filters and bioretention.

**Advantages**

- Reduces the amount of impervious cover and associated runoff and pollutants generated.
- Provides an opportunity for the siting of structural control facilities.
- Trees in parking lots provide shading for cars and are more visually appealing.

**Use**

- Break up expanses of parking with landscaped islands, which include shade trees and shrubs.
- Fewer large islands will sustain healthy trees better than more numerous very small islands.



Figure 4.13 – Bioretention in use as a parking lot island in Branford, CT. Source: Connecticut Department of Environmental Protection.

Structural control facilities such as filter strips, dry swales and bioretention areas can be incorporated into parking lot islands. Stormwater is directed into these landscaped areas and temporarily detained. The runoff then flows through or filters down through the bed of the facility and is infiltrated into the subsurface or collected for discharge into a stream or another stormwater facility. These facilities can be attractively integrated into landscaped areas and can be maintained by commercial landscaping firms.



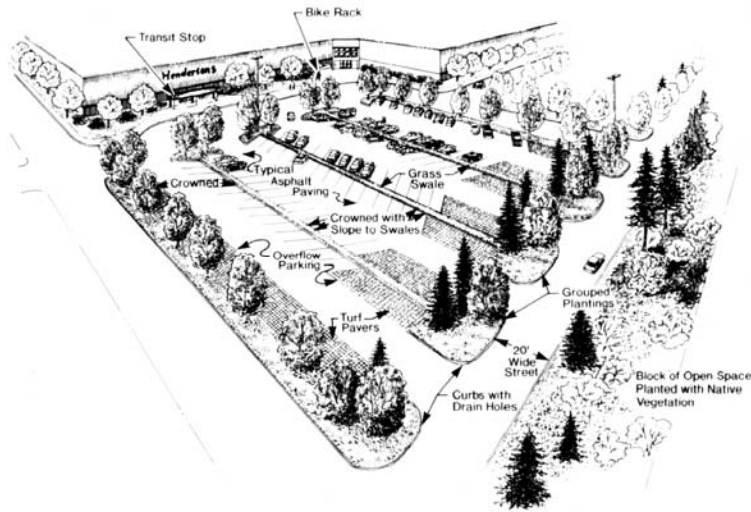

Figure 4.14 – Parking lot with islands attractively integrated. Source: Connecticut, 2004.

## Standards

Parking lot islands should:

- a) Be at least 8 feet wide.
- b) Be constructed with sub-surface drainage.
- c) Incorporate compaction resistant soil.

### 4.3.5 Permeable Pavement



Figure 4.15 – Permeable pavement. Source: Connecticut, 2004.

Permeable pavement is designed to allow rain and snowmelt to pass through it, thereby reducing runoff, promoting groundwater recharge, and filtering pollutants. Permeable paving materials include:

- Modular concrete paving blocks
- Modular concrete or plastic lattice
- Soil enhancement technologies
- Cast-in-place concrete grids
- Other materials such as gravel, Cobbles, wood, mulch, brick, and natural stone.

Porous asphalt or concrete (i.e., porous pavement or gap-graded pavement), which looks similar to traditional pavement but is manufactured without fine materials and incorporates additional void spaces, are only recommended for certain limited applications due to their potential for clogging and high failure rate in cold climates. Porous pavement is only recommended for sites that meet the following criteria:

- Low-traffic applications (generally 500 or fewer average daily trips or ADT).
- The underlying soils are sufficiently permeable (see Design Considerations below).
- Road sand is not applied.

Runoff from adjacent areas is directed away from the porous pavement by grading the surrounding landscape away from the site or by installing trenches to collect the runoff. Regular maintenance is performed (sweeping, vacuum cleaning).

### **Advantages**

- Reduces the amount of impervious cover and associated runoff and pollutants generated.
- Reduces the costs associated with road construction and maintenance.

### **Use**

- a) Applicable to small drainage areas.
- b) Low traffic (generally 500 ADT or less) areas of parking lots (i.e., overflow parking for malls and arenas), driveways for residential and light commercial use, walkways, bike paths, and patios.
- c) Roadside right-of-ways and emergency access lanes.
- d) Useful in stormwater retrofit applications where space is limited and where additional runoff control is required.
- e) In areas where snow plowing is not required.

### **Standards**

Chapter 11 of the current *Stormwater Quality Manual* includes specific design standards and considerations for permeable pavement, which should be followed when implementing these BMPs.

## **4.3.6 Disconnecting Impervious Areas**

Impervious surfaces that are separated from drainage collection systems by pervious surface or infiltrating BMPs contribute less runoff and reduced pollutant loading. Isolating impervious surface promotes infiltration and filtration of stormwater runoff.

### Advantages

- Promotes evapotranspiration and infiltration to reduce need for treatment and peak volume control at end-of-pipe.
- Reduces generation of stormwater.
- Maintains predevelopment hydrology, natural character and aesthetic features that may increase market value.

### Use

Use the following techniques to disconnect impervious surface from collection systems:

- Direct roof runoff and runoff from paved surfaces to stabilized vegetated areas such as buffers.
- Direct runoff from large impervious surfaces (over 5000 square feet) to more than one receiving area.
- Encourage sheet flow through vegetated areas.

### Standards

#### General

- Disconnect impervious surfaces to the extent practicable.
- Up to the first inch of runoff from an impervious surface may be disconnected to a pervious surface such as a lawn.

**Table 4.5**  
**Ratio of Open Space: Pervious Area Necessary to Attenuate Surface Runoff**  
**for Runoff Between 0.5 and 1.0 Inches<sup>a, b</sup>**

Runoff (inches)	HSG Soil Type			
	A	B	C	D
1.0	1:2	4:1	N/A	N/A
0.9	1:3	2:1	N/A	N/A
0.8	1:4	1:1	N/A	N/A
0.7	1:8	1:2	N/A	N/A
0.6	1:8	1:3	2:1	N/A
0.5	1:8	1:6	1:1	N/A

Notes:

<sup>a</sup>Buffer size calculations based on TR-55. Calculations for precipitation depths less than 0.5 inches are not included as the empirical equations of TR-55 become less accurate for storms less than 0.5 inches.

<sup>b</sup>Standards for buffer width and length of contributing flow path, etc. must be met regardless of soil's capacity to attenuate flow.

- c) Relatively permeable soils (hydrologic soil groups A and B) must be present for disconnection. Assume that the pervious surface is open space in good condition (i.e., CN of 39 for HSG A and 61 for HSG B). (If a forested buffer is being used refer to “Preserving Natural Areas” for appropriate standards.) The following impervious to pervious area ratios should be used. Type C and D may not be used for this purpose as open space on these soil types does not abstract the rainfall required to generate one inch of runoff from the impervious surface.
- d) The maximum contributing impervious flow path length should be no more than 75 feet.
- e) The disconnected area should drain continuously through a vegetated channel, swale, or filter strip to the property line or structural stormwater control.
- f) Flow from the impervious surface must enter the downstream pervious area as sheet flow.
- g) The length of the disconnected area should be equal to or greater than the contributing length.
- h) The entire disconnected area should maintain a slope less than or equal to 5 percent.
- i) The surface of the contributing imperviousness area should not exceed 5,000 square feet.

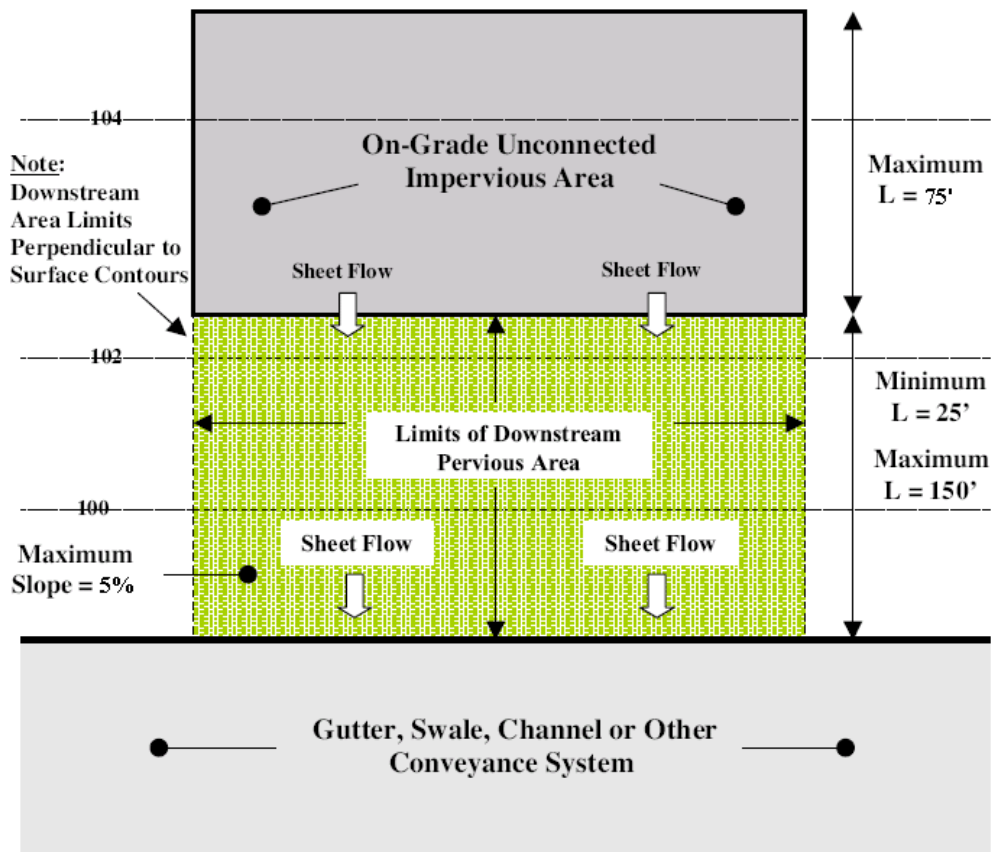

Figure 4.16 – Standards for disconnecting impervious surface via sheet flow. Source: New Jersey Department of Environmental Protection, 2004.

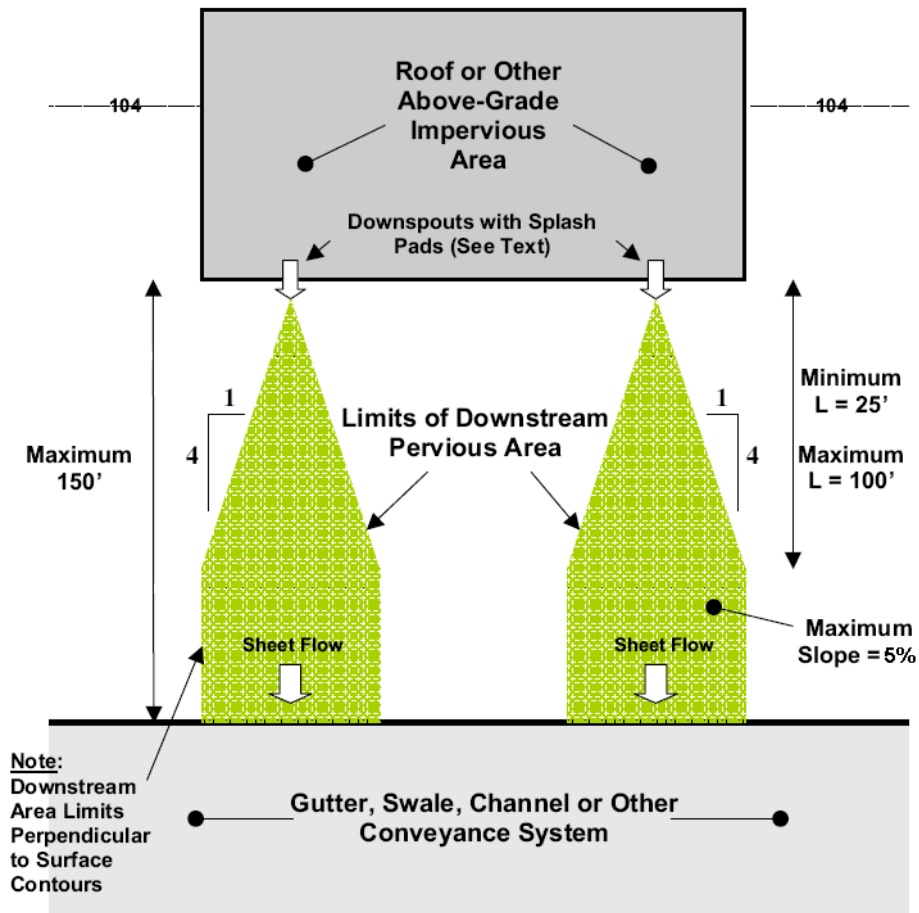

Figure 4.17 – Standards for disconnecting impervious surface via downspouts. Source: New Jersey Department of Environmental Protection, 2004.

### *Downspouts*

- Downspout outfall expands in width at a rate of 1:4 for a maximum length of 100 feet and a minimum length of 25 feet.
- No downspout may drain more than 600 square feet of roof.
- Downspouts should be at least 10 feet away from the nearest impervious surface (e.g., driveways) to discourage reconnections to those surfaces.
- Downspouts must be equipped with splash pads, level spreaders, or dispersion trenches that reduce flow velocity and induce sheet flow in the downstream pervious area.



## 4.4 Integrated Management Practices at the Source

### 4.4.1 Vegetated Filter Strips

A vegetated filter strip is an undisturbed densely vegetated area (e.g., well-tended lawn) contiguous with a developed area. These filter strips are most often located between a water resource and the developed portion of a site (see *Figure 4.18*).



Figure 4.18 – Vegetative filter strip. Source: Connecticut, 2004.

#### Advantages

Filter strips serve to improve runoff water quality, add or maintain wildlife habitat, and provide a screening effect for homeowners. This type of BMP is best suited for complementing other structural methods utilized on-site for stormwater management.

#### Use

Filter strips can be composed of an undisturbed-forested area or created from disturbed land by proper seeding and plantings. Where grass is being used, the most effective pollutant removal filter strip is composed of dense grassy vegetation that is properly maintained

Channelization of runoff within the filter strip significantly reduces the amount of infiltration and subsequent pollutant removal. Filter strips must have a level-spreading device incorporated into the design. Caution must be used when installing level spreaders to ensure long-term even flow and distribution of runoff to the filter strip. See *Figure 4.5* for an example of a level spreader. Low volume pedestrian pathways may be constructed through a buffer strip, provided they are no greater than 5 feet wide and take a winding course to reduce the potential for channelized runoff flow. Pesticides should not be applied in these areas, although minimal, fertilizer use is acceptable to help seeded areas become more quickly established. Incorporating organic material, such as mulch, into the topsoil is encouraged to promote better filter strip performance.

Soils with a high content of organic material will attenuate greater amounts of pollutants from stormwater runoff.

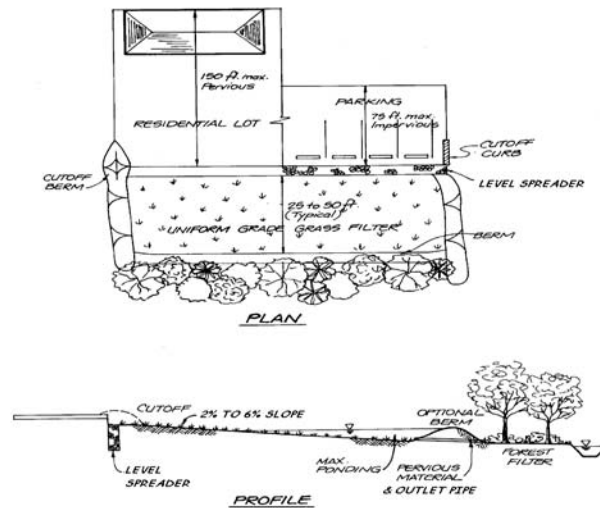

Figure 4.19 – Drawing of a vegetative filter strip. Source: Atlanta Regional Commission, 2001.

### Standards

Chapter 11 of the current *Stormwater Quality Manual* includes specific design standards and considerations for vegetative filter strips, which should be followed when implementing these BMPs.

## 4.4.2 Natural and Vegetated Drainage Ways

Structural drainage systems and storm sewers are designed to be hydraulically efficient for removing stormwater from a site. However, in doing so these systems tend to increase peak runoff discharges, flow velocities and the delivery of pollutants to downstream waters. An alternative is the use of natural drainage ways such as grass natural drainage systems (see *Figure 4.20*).

The use of natural open channels allows for more storage of stormwater flows on-site, lower stormwater peak flows, a reduction in erosive runoff velocities, infiltration of a portion of the runoff volume, and the capture and treatment of stormwater pollutants.



Figures 4.20 – Vegetated drainage way. Photograph courtesy of the University of Connecticut NEMO program, Kara Bonsack

### Advantages

- Reduces or eliminates the cost of constructing storm sewers or other conveyances, and may reduce the need for land disturbance and grading.
- Increases travel times and lower peak discharges.
- Can be combined with buffer systems to enhance stormwater filtration and infiltration.

### Use

- a) Use vegetated open channels in the street right-of-way to convey and treat stormwater runoff from roadways, particularly for low-density development and residential subdivisions where density, topography, soils, slope, and safety issues permit.
- b) Use vegetated open channels in place of curb and gutter to convey and treat stormwater runoff.
- c) Design drainage systems and open channels to:
  - i. Increase surface roughness to retard velocity.
  - ii. Include wide and flat channels to reduce velocity of flow and encourage sheet flow if possible.
  - iii. Increase channel flow path to increase time of concentration and travel time.

### Standards

Chapter 11 of the current *Stormwater Quality Manual* includes specific design standards and considerations for grass drainage channels, which should be followed when implementing these BMPs.

### 4.4.3 Green Roofs and Facades



Figure 4.21 – Aetna Building, Hartford, CT. Source: Connecticut Department of Environmental Protection.

Rooftop runoff management structures are modifications to conventional building design that retard runoff originating from roofs. The modifications include:

- Vegetated roof covers
- Roof gardens
- Vegetated building facades
- Roof ponding areas

Roofs are significant sources of concentrated runoff from developed sites. If runoff is controlled at the source, the size of other BMPs throughout the site can be minimal. Rooftop runoff management practices influence the runoff hydrograph in two ways:

- Intercept rainfall during the early part of a storm.
- Limit the maximum release rate.

In addition to achieving specific storm water runoff management objectives, rooftop runoff management can also be aesthetically and socially beneficial.

### **Advantages**

- Rooftop runoff management techniques can be retrofitted to most conventionally constructed buildings.
- Reduces energy consumption for heating and cooling.
- Conserves space.
- Reduces wear on roofs caused by UV damage, wind, and extremes of temperature. Vegetative roof covers can reduce bare roof temperatures in summer by as much as 40 percent.
- Roof gardens, vegetated roof covers, and vegetated facades add aesthetic value to residential and commercial property that attract songbirds, bees, and butterflies.
- Benefit water quality by reducing the acidity of runoff and trapping airborne particulates.
- May reduce the size of onsite runoff attenuation BMPs.

### **Use**

- a) Use vegetative roofs on residential, commercial and light industrial buildings.
- b) Vegetative roof systems are most appropriate on roofs with slopes of 12:1 to 4:1.
- c) Vegetative roofs may be used on flatter slopes if an underdrain is installed.

### **Design Variations**

- Vegetated roof cover – Vegetated roof covers, also called green roofs and extensive roof gardens, involve blanketing roofs with a veneer of living vegetation. Vegetative roof covers are particularly effective when applied to extensive roofs, such as those that typify commercial and institutional buildings. The filtering effect of vegetated roof covers results in a roof discharge that is free of leaves and roof litter. Therefore, it is recommended where roof runoff will be directed to infiltration devices (see Standards for Infiltration Practices and Dry Wells.)

Because of recent advances in synthetic drainage materials, vegetated covers now are feasible on most conventional flat roofs. An efficient drainage layer is placed between the growth media and the roof surface. This layer rapidly conveys water off of the roof surface and prevents water from “lying” on the roof. In fact, vegetated roof covers can be expected to protect roof materials and prolong their life.

If materials are selected carefully to reduce the weight of the system, vegetated roof covers generally can be created on existing flat roofs without additional structural support. Drainage nets or sheet drains constructed from lightweight synthetic materials can be used as underlayments to carry away water and prevent ponding. The total load of a fully vegetated and saturated roof cover system can be less than the design load computed for gravel ballast on conventional tar roofs.

Although vegetative roof covers are most effective during the growing season, they also are beneficial during the winter months as additional insulation if the vegetative matter from the dead or dormant plants is left in place and intact.

- Roof Gardens – Vegetated roof covers blanket an entire roof area and, although presenting an attractive vista, generally are not intended to accommodate routine traffic by people. Roof gardens, on the other hand, are landscaped environments, which may include planters and potted shrubs and trees. Roof gardens can be tailor-made natural areas, designed for outdoor recreation, and perched above congested city streets. Because of the special requirements for access, structural support, and drainage, roof gardens are found most frequently in new construction.

Roof gardens generally are designed to achieve specific architectural objectives. The load and hydraulic requirements for roof gardens will vary according to the intended use of the space. Intensive roof gardens typically include design elements such as planters filled with topsoil, decorative gravel or stone, and containers for trees and shrubs. Complete designs also may detain runoff ponding in the form of water gardens or storage in gravel beds. A wide range of hydrologic principles may be exploited to achieve storm water management objectives, including runoff peak attenuation and runoff volume control.

- Vegetated Building Facades – Vegetated facades provide many of the same benefits as vegetated roof covers and roof gardens, including the interception of precipitation and the retardation of runoff. However, their effectiveness is limited to small rainfall events.

Vertical facades and walls of houses can be covered with the foliage of self-climbing plants that are rooted in the ground and reach heights in excess of 80 feet. Vines can be evergreen or prolific deciduous flowering plants. As for roof gardens, the designer must be judicious in selecting plant species that will prosper in the constructed environment. Planters and trellises can be installed so that vegetation can be placed strategically.

- Roof Ponding – Roof ponding is applicable where the increased load of impounded water on a roof will not increase the building costs significantly or require extensive reinforcement. Roof ponding generally is not viable for large-area commercial buildings



where clear spans are required. Special consideration must be given to ensuring that the roof will remain watertight under a range of adverse weather conditions. Low-cost plastic membranes can be used to construct an impermeable lining for the containment area.

Flat roofs can be converted to ponding areas by restricting the flow to downspouts. Even small ponding depths of 1 or 2 inches can attenuate storm water-runoff peaks effectively for most storms.

### **Design Considerations**

Rooftop measures are primarily peak runoff attenuation measures. The methods for evaluating the peak attenuation properties of these measures are based on approaches used for other peak runoff attenuation BMPs. The emphasis of the design should be promoting rapid roof drainage and minimizing the weight of the system. By using appropriate materials, the total weight of fully saturated vegetated roof covers can readily be maintained below 20 pounds per square foot (psf). Because of the many factors that may influence the design of vegetated roof covers, it is advisable to obtain the services of installers that specialize in this area.

Rainfall retention properties are related to field capacity and wilting point. Appropriate media for this application should be capable of retaining water at the rate of 40 percent by weight, or greater. The media must be uniformly screened and blended to achieve its rainfall retention potential. During the early phases of a storm, the media and root systems of the cover will intercept and retain most of the rainfall, up to the retention capacity. For instance, 3-inch cover with 40 percent retention potential will effectively control the first 1.2 inches of rainfall. Although some water will percolate through the cover during this period, this quantity generally will be negligible compared to the direct runoff rate without the cover in place.

Once the field capacity of the cover is attained, water will drain freely through the media at a rate that is approximately equal to the saturated hydraulic conductivity for the media. Through the selection of the media, the maximum release rate from the roof can be controlled. The media is a mechanism for “buffering” or attenuating the peak runoff rates from roofed areas. Rooftop runoff management measures generally are more effective in controlling storms that generate 1 inch or less of runoff (i.e., 1.2-inch storm). However, because storms of this size constitute the majority of rainfall events, rooftop runoff measures can be important in planning for comprehensive storm water management. These measures are particularly useful when linked to groundwater recharge BMPs such as infiltration trenches, dry wells, and permeable pavements. By retaining rainfall for evaporation or plant transpiration, some rooftop runoff management measures, such as vegetated roof covers, can also achieve significant reductions in total annual runoff. This attenuation of runoff peaks from larger storms should be taken into account when sizing related runoff peak attenuation at the site.

By using specific information about the hydraulic properties of the cover media, the effect of the roof cover system on the runoff hydrograph can be approximated with numerical modeling techniques. As appropriate, the predicted hydrographs can be added into site-wide runoff models to evaluate the effect of the vegetative roof covers on site runoff. The hydraulic analysis of roof covers will require the services of a professional engineer who is experienced with drainage design.

### ***Impermeable Lining***

- a) In some instances, the impermeable lining can be the watertight tar surface, which is conventional for flat roof construction. However, where added protection is desired, a layer of plastic or rubber membrane can be installed immediately beneath the drainage net or sheet drain. This liner needs to be designed by a professional engineer to ensure proper function.
- b) If membranes are used, their resistance to ultraviolet (UV) radiation, extremes of temperature, and puncture must be known. In most cases, covering the sealing material with a protective layer of gravel or geotextile is advisable.

### ***Drainage***

- a) The drainage net or sheet drain is a continuous layer that underlies the entire cover system. A variety of lightweight, high-performance drainage products will function well in this environment. The product selected should be capable of conveying the discharge associated with the runoff peak attenuation storm without ponding water on top of the roof cover. When evaluating a drainage layer design, the roof topography should be evaluated to establish where the longest travel distances to a roof gutter, drain, or downspout occur. If flow converges near drains and gutters, the design unit-flow rate should be increased accordingly.
- b) Drainage nets or sheet drains with transmissivities of 15 gallons per minute per foot, or larger, are recommended.
- c) The drainage layer should be able to convey the design unit flow rate at the roof grade without water ponding on top of the cover media. For larger storms, direct roof runoff is permitted to occur. The design flow rates should be based on the largest runoff peak attenuation design storm considered in the design.
- d) To prevent the growth media from penetrating and clogging the drainage layer and to prevent roots from penetrating the roof surface, a geotextile should be installed immediately over the drainage net or sheet drain. Many vendors will bond the geotextile to the upper surface of the drainage material.
- e) Effective roof garden designs will ensure that all direct rainfall is cycled through one or more devices before being discharged to downspouts as runoff. For instance, rainfall collected on a raised tile patio can be directed to a media-filled planter where some water is retained in the root zone and some is detained and gradually discharged through an overflow to the downspout.
- f) In the case of roof ponding, devices such as the one shown in *Figure 4.22*, are easily fabricated. However, some form of emergency overflow also is advisable. Emergency overflow can be as simple as a free overfall through a notch in the roof parapet wall.

- g) In roof ponding systems, because the roof is impermeable, the runoff hydrograph is simply the rainfall distribution for the design storm multiplied by the area of the roof.

The depth to storage relationship can be computed from the topography of the roof. For perfectly flat roofs, the storage volume of a ponding level is equal to the roof area times the ponding level. The depth-discharge relationship in will be unique to the outlet device used. For simple ponding rings on flat roofs, the discharge rate will approximately equal:

$$q = 3.141 CD (d - H)^{3/2}$$

Where:

- q = outflow rate
- C = discharge coefficient (Varies based on design) Typical: C = 3.0
- D = diameter of the ring
- d = depth of ponding
- H = height of the ring

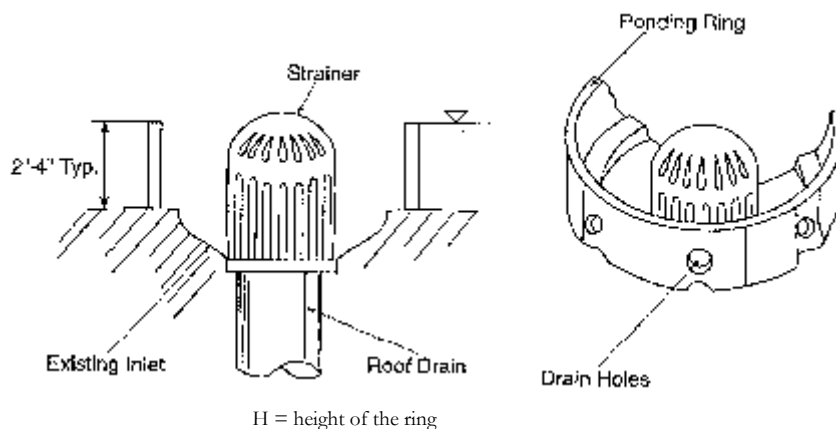

Figure 4.22 – Roof ponding rings. Source: Tourbier, 1974.

### ***Roof Loading***

The net weight of the fully vegetated roof cover should be compared against the design loads for the roof.

### ***Lightweight Growth Media***

- a) The depth of the growth media should be kept as small as the cover vegetation will allow. Typically, a depth of 3 to 4 inches will be sufficient. Low-density substrate materials with good water-retention capacity should be specified. Examples are mixtures containing crushed pumice and terra cotta. Media that are appropriate for this application will retain 40 to 60 percent water by weight and have bulk dry densities of between 35 and 50 lb/cubic foot. Earth and topsoil are too heavy for most applications.

- b) Hydrologic properties are specific to the growth medium. If the supplier does not provide information, prospective media should be laboratory tested to establish porosity, moisture content at field capacity, moisture content at the wilting point (nominally 0.33 bar), and saturated hydraulic conductivity.

### ***Adapted Plants and Grasses***

- a) A limited number of plants can thrive in the roof environment where periodic rainfall alternates with periods that are hot and dry. Effective plant species must:
  - i. Tolerate mildly acidic conditions and poor soil;
  - ii. Prefer very-well-drained conditions and full sun;
  - iii. Tolerate dry soil;
  - iv. Be vigorous colonizers.

Both annual and perennial plants can be used. Dozens of species have been successfully field-tested. Among these, some species of sedum (*Sedum*) have been shown to be particularly well adapted. Other candidates include hardy species of sedge (*Carex*), fescue (*Festuca*), feather grass (*Stipa*), and yarrow (*Achillea*).

- b) Vegetative roof covers may include provisions for occasional watering during extended dry periods. Conventional lawn sprinklers work well.
- c) The key to developing an effective vegetated facade is selecting plants that are well adapted to the conditions in which they must grow. For instance, depending on the location, plants may encounter shade or full sun. Plants that will provide thick foliage should be selected. Some plants with good climbing and foliage characteristics are ivy (*Hedera*), honeysuckle (*Lonicera*), wisteria (*Wisteria*), Virginia creeper (*Parthenocissus*), trumpet creeper (*Campsis*), and hardy cultivars of clematis (e.g., *Clematis paniculata*). Some of these plants will require a trellis or lattice to firmly support the vines.

### ***Inspection and Maintenance***

- a) Plans for water quality swales should identify detailed inspection and maintenance requirements, inspection and maintenance schedules, and those parties responsible for maintenance.
- b) All rooftop runoff management measures must be inspected and maintained periodically. Furthermore, the vegetative measures require the same normal care and maintenance that a planted area does. The maintenance includes attending to plant nutritional needs, irrigating as required during dry periods, and occasionally weeding.
- c) The cost of maintenance can be significantly reduced by judiciously selecting hardy plants that will outcompete weeds.
- d) In general, fertilizers must be applied periodically. Fertilizing usually is not a problem on flat or gently sloping roofs where access is unimpeded and fertilizers can be uniformly broadcast.

- e) Properly designed vegetated roof covers should not be damaged by treading on the cover system.
- f) When retrofitting existing roofs, preserve easy access to gutters, drains, spouts, and other components of the roof drainage system.
- g) It is good practice to thoroughly inspect the roof drainage system quarterly. Foreign matter, including leaves and litter, should be removed.

**Table 4.6  
Typical Maintenance Activities for Rooftop Runoff Structures**

Activity	Schedule
<ul style="list-style-type: none"> <li>• Inspect to ensure vegetative cover is established</li> <li>• Remove foreign matter, leaves, and litter</li> </ul>	Quarterly
<ul style="list-style-type: none"> <li>• Irrigate/Water</li> <li>• Weed</li> </ul>	As necessary
<ul style="list-style-type: none"> <li>• Apply fertilizers to flat or gently sloped roofs</li> </ul>	As necessary
<ul style="list-style-type: none"> <li>• Repair erosion on side slopes with seed or sod</li> </ul>	As necessary

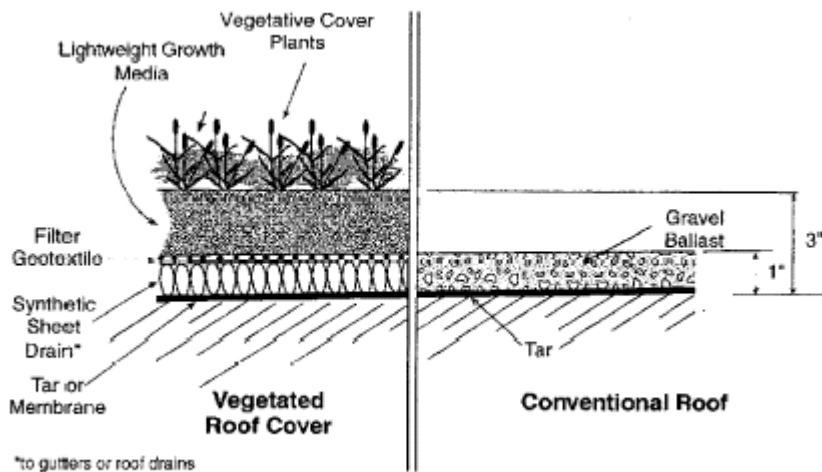

Figure 4.23 – Example Vegetated Rooftop Cross-Section

#### 4.4.4 Rain Barrels and Cisterns

Rain barrels and cisterns are rainwater collection and storage devices (see *Figure 4.24*). They are generally low-cost and easily maintainable. They are applicable, for purposes of retrofit, to residential, commercial and industrial sites to manage rooftop runoff. Rain barrels and cisterns are not generally given stormwater management credit on new development.



Cisterns are generally larger than rain barrels, with some underground cisterns having the capacity of 10,000 gallons or more. Water collected in cisterns is typically used for irrigation or in some instances as a potable supply.



Figure 4.24 – Example of a rain barrel. Source: Connecticut Department of Environmental Protection.

### Advantages

- Low cost.
- Applicable to a wide range of sites (e.g., residential, commercial industrial, etc.).
- Provide retention and detention of runoff from roofs.
- Can provide reuse of water for landscape irrigation.

### Use

- a) Use rain barrels and cisterns in commercial, industrial and domestic settings.
- b) Incorporate rain barrels and cisterns when a building is being designed so that they can be blended into the landscape. They can also be retrofitted.
- c) Size rain barrels and cisterns based on roof area. The required capacity of a rain barrel is a function of the rooftop surface evaporative water losses and initial abstraction.

Rain barrel volume can be determined by calculating the roof top water yield for any given rainfall, using Equation 10. A general rule of thumb to utilize in the sizing of rain barrels is that 1 inch of rainfall on a 1000-square-foot roof will yield approximately 600 gallons.

$$V = A^2 \times R \times 0.90 \times 7.5 \text{ gals/ft}^3$$

where:

- $V$  = volume of rain barrel (gallons)
- $A^2$  = surface area roof (square feet)
- $R$  = rainfall (feet)
- 0.9 = losses to system (no units)
- 7.5 = conversion factor (gallons per cubic foot)

Example: one 60-gallon barrel would provide runoff storage from a rooftop area of approximately 215 square feet for a 0.5 inch (0.042 ft.) of rainfall.

$$60 \text{ gallons} = 215 \text{ ft.}^2 \times 0.042 \text{ ft.} \times 0.90 \times 7.5 \text{ gallons/ft.}^3$$

- d) If collected water will be used as a drinking source, the system will generally require local authority review and approval.
- e) Assure long-term function by establishing maintenance agreements.

## Standards

Chapter 4 of the current *Stormwater Quality Manual* includes specific design standards and considerations for rain barrels and cisterns, which should be followed when implementing these BMPs.

### 4.4.5 Dry Wells

A dry well is a small, excavated pit, backfilled with stone aggregate. Dry wells function like infiltration systems to control roof runoff and are applicable for most types of buildings (see *Figure 4.25*).

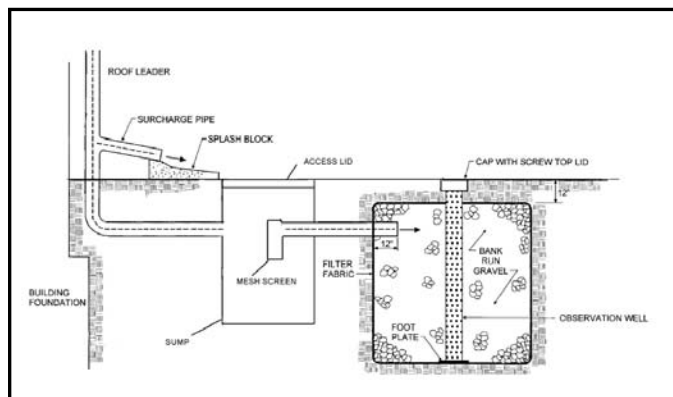

Figure 4.25 – Schematic of a drywell with optional sump to facilitate cleanout. Source: Adapted from New York, 2001.

#### Advantages

- Low cost.
- Applicable to a wide range of sites (e.g., residential, commercial industrial, etc.).
- Provides retention of runoff from roofs.
- Recharges groundwater.
- Reduces need for end-of-pipe treatment.

#### Use

- a) Dry wells can be useful for disposing of roof runoff and reducing the overall runoff volume from a variety of building sites.
- b) Infiltration of rooftop runoff from commercial or industrial buildings with pollution control, heating, cooling, or venting equipment may require UIC review and approval.

## Standards

Chapter 4 and 11 of the current *Stormwater Quality Manual* include specific design standards and considerations for dry wells, which should be followed when implementing these BMPs.

### 4.4.6 Bioretention and Rain Gardens



Figure 4.26 – Bioretention at University of Connecticut Storrs Campus –Mansfield. Source: Connecticut Department of Environmental Protection.

Bioretention and rain gardens are shallow landscaped depressions designed to manage and treat storm water runoff. Bioretention systems are a variation of a surface sand filter, where the sand filtration media is replaced with a planted soil bed designed to remove pollutants through physical and biological processes (EPA, 2002). The concept of bioretention originated with the Prince George's County, Maryland, Department of Environmental Resources in the early 1990s as an alternative to more traditional management practices. Storm water flows into the bioretention area, ponds on the surface, and gradually infiltrates into the soil bed. Treated water is allowed to infiltrate into the

surrounding soils or is collected by an underdrain system and discharged to the storm drain system or receiving waters. Small-scale bioretention applications (i.e., residential yards, median strips, parking lot islands) are commonly referred to as rain gardens (*Figure 4.27*).



Figure 4.27 – Rain garden. Source: Connecticut Department of Environmental Protection.

### Advantages

- Applicable to small drainage areas, storm water retrofits and highly developed sites.
- Can be applied to most sites due to relatively few constraints and many design variations (i.e., highly versatile).
- High solids, metals, and bacteria removal efficiency.
- Infiltrating bioretention can provide groundwater recharge.
- Helps to mimic predevelopment runoff conditions.
- Reduces need for end-of-pipe treatment.

### Use

- a) Bioretention may be used in a wide variety of settings including residential, commercial, and industrial areas.
- b) May be decentralized (e.g., as rain gardens on individual lots) or centralized in common areas to manage multiple properties.
- c) May be lined and underdrained; or designed to infiltrate and recharge groundwater.

### Standards

Chapter 4 and 11 of the current *Stormwater Quality Manual* include specific design standards and considerations for bioretention, which should be followed when implementing these BMPs.

#### 4.4.7 Infiltration Trenches

An infiltration trench is an excavated trench that has been back-filled with stone to form a subsurface basin. Stormwater runoff is diverted into the trench and is stored until it can be infiltrated into the soil, unusually over a period of 1 – 2 days.



Figure 4.28 – Infiltration trench. Source: Connecticut Department of Environmental Protection.

### Advantages

- Applicable to small drainage areas, storm water retrofits and highly developed sites.
- High bacteria removal efficiency.



- Infiltration provides groundwater recharge.
- Helps to mimic predevelopment runoff conditions.
- Reduces need for end-of-pipe treatment.

### **Use**

- a) Infiltration may be useful for disposing of roof runoff (e.g., dry wells), or runoff from parking lots and roadways.
- b) Infiltration trenches generally have a longer life cycle when hydrologically preceded by pretreatment such as a vegetated filter strip.
- c) Infiltration generally requires UIC review and approval.

### **Standards**

Chapter 11 of the current *Stormwater Quality Manual* includes specific design standards and considerations for infiltration, which should be followed when implementing infiltration BMPs.



## 5 References

- Atlantic Regional Commission (ARC). 2001. *Georgia Stormwater Management Manual*. [No municipality of publication].
- Bobrowski, Mark and Teitz, Andrew. 2001. *Model Land Use Ordinances*. Providence, RI.
- Burton, G.A., & R.E. Pitt, 2002. *Stormwater Effects Handbook. A Toolbox for Watershed Managers, Scientists, and Engineers*. Lewis Publishers. New York, NY.
- Center for Watershed Protection (CWP). 2000. *The Practice of Watershed Protection*. Ellicott City, Maryland.
- Center for Watershed Protection (CWP). 1996. *Review Draft: Pollutant Removal Database of Current Urban Stormwater Best Management Practices*. Silver Spring, Maryland.
- Center for Watershed Protection (CWP). [no publication date]. *Better Site Design: An Assessment of the Better Site Design Principles for Communities Implementing Virginia's Chesapeake Bay Preservation Act*. Ellicott City, Maryland.
- Center for Watershed Protection (CWP). 2000. *Better Site Design: A Handbook for Changing Development Rules in Your Community*. Ellicott City, Maryland.
- Center for Watershed Protection (CWP). 2002. *Vermont Stormwater Management Manual. Vermont Agency of Natural Resources*. Waterbury, VT.
- Center for Watershed Protection (CWP). [no publication date]. Better Site Design Fact Sheet: Narrow Residential Streets. [http://www.stormwatercenter.net/Assorted%20Fact%20Sheets/Tool4\\_Site\\_Design/narrow\\_streets.htm](http://www.stormwatercenter.net/Assorted%20Fact%20Sheets/Tool4_Site_Design/narrow_streets.htm)
- Connecticut Department of Environmental Protection (DEP). 1995. *Connecticut Stormwater Quality Manual (draft)*. Bureau of Water Management. Planning and Standards Division. Hartford, Connecticut.
- Connecticut Department of Environmental Protection (DEP). 1995. *Connecticut Stormwater Quality Planning: A Guide for Municipal Officials and Regional Planners (draft)*. Bureau of Water Management. Planning and Standards Division. Hartford, Connecticut.
- Cyre, Hector J. (1982). "Stormwater Management Financing." *Houston: American Public Works Association*.
- Cyre, Hector J. (1983). "New Options for Stormwater Financing." *APWA Reporter*. Houston: American Public Works Association.

- Frisman, Paul. (2004). "Storm Water Utilities." *Hartford: Office of Legal Research*.
- Malcolm Pirnie. (Interim Draft 2009). *Stormwater Pilot Program Interim Report*. White Planes: Author.
- Gibbons, Jim. 1999. Nonpoint Source Education for Municipal Officials: Roads. [http://www.nemo.uconn.edu/publications/tech\\_papers/tech\\_paper\\_9.pdf](http://www.nemo.uconn.edu/publications/tech_papers/tech_paper_9.pdf)
- Horsley and Whitten. [No publication date]. *Urban Stormwater Planning Handbook: A Survey of Innovative Structural Stormwater Best Management Practices*. [No municipality of publication].
- Institute of Transportation Engineers (ITE). 1987. Parking Generation. 2<sup>nd</sup> Edition. Institute of Transportation Engineers, Washington, DC. 220 pp.
- Metropolitan Council. 2001. *Minnesota Urban Small Sites BMP Manual: Stormwater Best Management Practices for Cold Climates*. Prepared by Barr Engineering Company. St. Paul, Minnesota.
- Metropolitan Council Environmental Services. 2003. *Urban Small Sites Best Management Practice Manual*. <http://www.metrocouncil.org/environment/Watershed/bmp/manual.htm>
- Milone & MacBroom, Inc. (2005). *Stormwater Utility Feasibility Study, Stonington, Connecticut*. Cheshire: Author.
- Milwaukee River Basin Partnership. [no publication date]. Protecting Our Waters: Streets and Roads. <http://clean-water.uwex.edu/plan/streetsroads.htm>
- Municipal Stormwater Authority Pilot Program, Public Act 7-154 (2007)*.
- Natural Resources Defense Council (NRDC). 1999. *Stormwater Strategies: Community Responses to Runoff Pollution*.
- New Jersey Department of Environmental Protection (NJDEP). 2000. *Revised Manual for New Jersey: Best Management Practices for Control of Nonpoint Source Pollution from Stormwater*, Fifth Draft, May 3, 2000.
- New York State Department of Environmental Conservation (NYDEC). 2001. *New York State Stormwater Management Design Manual*. Prepared by Center for Watershed Protection. Albany, New York.
- Nonpoint Education for Municipal Officials (NEMO) website, URL: <http://nemo.uconn.edu>.
- Pennsylvania Association of Conservation Districts, Keystone Chapter Soil and Water Conservation Society, Pennsylvania Department of Environmental Protection, and Natural Resources Conservation Service. 1998. *Pennsylvania Handbook of Best Management Practices for Developing Areas*. Prepared by CH2MHILL.
- Pitt, R. 1999. Department of Civil and Environmental Engineering, University of Alabama at Birmingham.

Prince Georges County, Maryland, Department of Environmental Resources (PGDER), 1999. *Low-Impact Development Design Strategies, An Integrated Design Approach*. Prince Georges County, Maryland.

Pudget Sound Action Team. 2003. *Natural Approaches to Stormwater Management: Low Impact Development in Pudget Sound*. Olympia, WA.

Rhode Island Department of Environmental Management (RIDEM). 1993. *State of Rhode Island, Stormwater Design and Installation Standards Manual*. Providence, RI.

Schueler, Tom. 1995. *Environmental Land Planning Series: Site Planning for Urban Stream Protection*. Silver Spring, MD.

Schueler, T.R., Kumble, P.A., and M.A. Heraty. 1992. *A Current Assessment of Urban Best Management Practices: Techniques for Reducing Non-Point Source Pollution in the Coastal Zone*. Department of Environmental Programs. Metropolitan Washington Council of Governments.

Schueler, T.R. 1994. "The Importance of Imperviousness". *Watershed Protection Techniques*. Vol. 1, No. 3.

Schueler, T.R. 1995. *Site Planning for Urban Stream Protection*. Metropolitan Washington Council of Governments. Washington, D.C.

Schueler, T.R. 1999. "Microbes and Urban Watersheds". *Watershed Protection Techniques*. Vol. 3, No. 1.

Schueler, T.R., Kumble, P.A., and M.A. Heraty. 1992. *A Current Assessment of Urban Best Management Practices: Techniques for Reducing Non-Point Source Pollution in the Coastal Zone*. Department of Environmental Programs, Metropolitan Washington Council of Governments.

Seattle Public Utilities District. 2003. Street Edge Alternatives (SEA Streets) Project. [http://www.seattle.gov/util/About\\_SPU/Drainage\\_&\\_Sewer\\_System/Natural\\_Drainage\\_Systems/Street\\_Edge\\_Alternatives/index.asp](http://www.seattle.gov/util/About_SPU/Drainage_&_Sewer_System/Natural_Drainage_Systems/Street_Edge_Alternatives/index.asp)

Soil Conservation Service. 1986. *Urban Hydrology for Small Watersheds, USDA Soil Conservation Service Technical Release No. 55*. Washington, D.C.

Stahre, Peter and Urbonas, Ben. 1990. *Stormwater Detention For Drainage, Water Quality, and CSO Management*. Prentice Hall: Englewood Cliffs, NJ.

Traintor, Frederick F. 2001 *Farming and Forestry Strategies*. Providence, RI.

Treadway, Elizabeth and Reese, Andrew. (2000). "Financial Strategies for Stormwater Management." *APWA Reporter*. Houston: American Public Works Association.

United States Environmental Protection Agency (EPA), 2002. *National Management Measures to Control Nonpoint Source Pollution from Urban Areas (Draft)*. Washington, D.C.

United States Environmental Protection Agency (EPA). 1983. *Results of the Nationwide Urban Runoff Program, Volume 1, Final Report*. Water Planning Division. Washington, D.C. NTIS No. PB 84-185 552.

United States Environmental Protection Agency (EPA). [no publication date]. *Post-Construction Storm Water Management in New Development & Redevelopment: Alternative Turnarounds*. [http://cfpub.epa.gov/npdes/stormwater/menuofbmps/post\\_2.cfm](http://cfpub.epa.gov/npdes/stormwater/menuofbmps/post_2.cfm)

US Environmental Protection Agency (EPA) New England. (2009). “*Funding Stormwater Programs*” (Report No. EPA 901-F-09-004).

Walker, W. 1990. *P8 Urban Catchment Model*. IEP, Inc. for the Narragansett Bay Project NBP-90-50. Narragansett Bay Project: Providence, RI.