

Traffic Control Signal Design Manual



Connecticut Department of Transportation
Bureau of Engineering and Construction
Division of Traffic Engineering
2009

Revision 3
May 2017



Traffic Control Signal Design Manual

Connecticut Department of Transportation
Bureau of Engineering and Construction
Division of Traffic Engineering
2009

This manual presumes that a traffic engineering study traffic signal control is needed. This document is intended to provide guidelines for certain considerations involved in the design of such devices.

Some of the information contained in this manual reflects departmental policy and State Traffic Commission Regulations as of July 2009. In the event that policy or regulations are changed such that they conflict with information in this manual, the revised policy/regulations will supersede.

REVISION 3 REVIEW COMMITTEE

Roger E. Beaudoin

Natasha A. Fatu, P.E., PTOE

David P. Rundio

Michael A. Chachakis

Michael A. Juliano

Gregory R. Palmer, P.E., Chairman

TABLE OF CONTENTS

LIST OF FIGURES	1	Rev. 3
REFERENCES	1	
1 PRELIMINARY CONSIDERATIONS	2-1	
2 DESIGN VOLUMES	2-1	
3 INTERSECTION CHANNELIZATION DESIGN GUIDELINES.....	3-1	
Left-Turn Lanes.....	3-1	
Right-Turn Lanes.....	3-2	
Dual Turn Lanes.....	3-2	
4 PHASING.....	4-1	
Phasing Sequences.....	4-1	
Left-Turn Display Options	4-3	
Permitted Only Phasing.....	4-3	
Advance Green Protected Only Phasing	4-3	
Advance Green Protected-Permitted Phasing	4-3	
Split Phasing	4-4	
Single Point Urban Interchange (SPUI)	4-4	
Prohibited Left-Turns.....	4-4	
Lag Green Signal Phasing	4-10	
Protected Only Lag Green Phasing	4-10	
Permitted/Protected Lag Green Phasing	4-10	
Lead-Lag Green Phasing.....	4-10	
Quad Signal Phasing.....	4-15	
Overlaps.....	4-20	
Standard Overlaps.....	4-20	
Non-Standard Overlaps.....	4-21	
Single Stage Crossing	4-25	
Two Stage Crossing	4-25	
Operation	4-25	
5 CAPACITY ANALYSIS	5-1	
Lost Time.....	5-1	
Cycle Length - Webster's Equation	5-1	
6 SIGNAL TIMING	6-1	
Maximum Green.....	6-1	
Minimum Green	6-1	
Vehicle Extension.....	6-1	
Gap Reduction	6-2	
Variable Initial.....	6-2	
Min/Max Timing Range (Town Signals)	6-3	
Clearance Intervals	6-3	

7	DETECTION	7-1	
	Detection.....	7-1	
	Controller Operation.....	7-1	
	Detection Mode/Features	7-1	
	Detection Area Design Guidelines	7-2	
	Dilemma Zone.....	7-3	
	Left-Turn Lane Detection	7-5	
	Side Street Detection.....	7-6	Rev. 3
	System Detection	7-6	
	Miscellaneous	7-6	
	Vehicular Detection Systems	7-7	
	Video Detection Guidelines	7-7	
	Wireless Detection Guidelines	7-10	
	Loop Detection Guidelines.....	7-11	
	Microwave Detection Guidelines	7-12	
	Bicycle Detection Guidelines	7-13	
8	FLASHING OPERATION	8-1	
	Flashing Operation	8-1	Rev. 3
	Maintenance Level	8-1	
9	PRE-EMPTION.....	9-1	
	Emergency Vehicle Pre-Emption	9-1	
	Railroad Pre-Emption.....	9-5	
	Ramp Pre-emption	9-8	
	Pre-Emption Definitions.....	9-10	
	Pre-Emption Settings Definitions.....	9-11	
10	TRAFFIC SIGNAL EQUIPMENT	10-1	
	Signal Head Location	10-1	
	Visual Shielding Devices	10-2	
	Visors.....	10-3	
	Louvers	10-3	
	Visibility Limiting Signals.....	10-3	
	Backplates.....	10-3	
	Signal Lens Size and Type	10-5	
	Signal Support Structures	10-5	
	Span Wire Design Guidelines	10-7	
	Mast Arm Design Guidelines	10-11	
11	PEDESTRIAN/BICYCLIST CONSIDERATIONS.....	11-1	
	Pedestrian Actuated Side Street Green.....	11-2	
	Pedestrian Actuated Walk/Don't Walk	11-2	
	Accessible Pedestrian Signals (APS)	11-3	
	Countdown Pedestrian Signals	11-4	
	Bicyclist Considerations.....	11-5	
12	SIGNING AND PAVEMENT MARKINGS	12-1	
13	MERRITT PARKWAY GUIDELINES	13-1	

14 FLASHING MESSAGE SIGNS.....	14-1
Inadequate Visibility to a Queue of Stopped Vehicles.....	14-2
Inadequate Visibility to Signal Heads	14-6
15 ELECTRICAL CONSIDERATIONS.....	15-1
Governing Codes, Regulations, and Standards	15-1
Pre-design Site Inspection	15-3
Handholes and Cast Iron Junction Boxes	15-4
Electrical Conduits	15-6
Installation Methods.....	15-7
<i>Surface</i>	15-7
Vehicle Detectors	15-8
Inductive Loop Detector (ILD).....	15-8
Video Image Detector System (VIDS).....	15-10
Microwave Detector.....	15-10
Others.....	15-10
Traffic Signal and Pedestrian Wiring.....	15-11
Utility Considerations.....	15-13
Electric Service.....	15-23
Source	15-23
Traffic Signal Requirements	15-23
Metered.....	15-24
Unmetered.....	15-24
Request for Service/Power Letter	15-24
Telephone Service	15-25
Powered Signs	15-25
Alternate Flashing Signals on Warning Sign.....	15-26
Internally Illuminated Warning or Advisory Sign	15-26
Interconnect	15-27
Type	15-27
<i>Twisted Pair Cable</i>	15-27
<i>Fiber Optic Cable</i>	15-28
<i>Signal Cable</i>	15-28
Plans, Specifications and Estimates	15-34
Plans.....	15-34
Specifications	15-34
Estimates	15-35
Miscellaneous	15-36
Location Numbering System.....	15-36
Uninterruptible Power Source.....	15-37
Illumination.....	15-37
Use of Construction Notes	15-38
Use of Technical Notes.....	15-38
Scrap and Salvaged Material.....	15-38
16 SIGNAL PLAN LAYOUT	16-1

17	SIGNAL SYSTEMS	17-1
	Signal System Coordination Types	17-1
	Procedure for Determining System Type	17-2
	Traffic Engineering Analysis	17-2
	Systems Analysis	17-3
	Selection of Alternative Systems.....	17-3
	Signal Coordination System Selection Work Sheet	17-4
	Signal System Concurrence Sheet	17-5
	Time-Space Diagrams	17-7
	Closed Loop System Design.....	17-10
	System Detection	17-12
	Time Base System Design	17-15
18	SIGNAL OWNERSHIP AND MAINTENANCE	18-1
	Ownership and Maintenance	18-1
	Installation Costs of Warranted Signals	18-2
	Electrical Energy Costs	18-4
19	SIGNAL DESIGN CHECK LIST.....	19-1
	Timing and Sequence	19-4
	Estimates for Projects	19-5
20	CLEAR ZONE CHART	20-1
21	DRAFTING GUIDELINES FOR CONSULTANTS	21-1
	Preliminary Design Requirements	21-1
	Semi-final Design Requirements	21-2
	Final Design Requirements	21-2
	Legend Used on Signal Plans	21-4
	Roadside and ROW Conventions	21-5
	Pavement Markings	21-6
	Signal Appurtenances	21-7
	Sample Intersection Layout	21-8
	CADD Text Sizes	21-9
	Traffic Signal Faces.....	21-10
	Movement Diagram	21-11
	Energy Block	21-12
	Metric Dimensional Guide	21-13
	Commonly Used Construction Notes	21-14
22	GLOSSARY	22-1
23	SIGNAL MANUAL COMMENT SHEET	23-1

LIST OF FIGURES

Page

FIGURE 3-1 DESIGN OF DUAL LEFT-TURN LANES	3-4	
FIGURE 4-1 NEMA SINGLE RING DIAGRAM	4-1	
FIGURE 4-2 NEMA DUAL RING, QUAD/SEQUENTIAL DIAGRAM	4-2	
FIGURE 4-3 NEMA DUAL RING, DUAL QUAD (QUAD LEFT-TURN) DIAGRAM	4-2	
FIGURE 4-4 NEMA DUAL RING, SEQUENTIAL/QUAD DIAGRAM.....	4-2	
FIGURE 4-5 PERMITTED ONLY PHASING.....	4-5	
FIGURE 4-6 ADVANCE GREEN (PROTECTED ONLY).....	4-6	
FIGURE 4-7A ADVANCE GREEN (PROTECTED/PERMITTED)	4-7	Rev. 3
FIGURE 4-7B ADVANCE GREEN (FIXED ADVANCE).....	4-8	
FIGURE 4-8 SPLIT PHASING	4-9	
FIGURE 4-9 LAG GREEN (PROTECTED ONLY).....	4-11	
FIGURE 4-10 LAG GREEN (PERMITTED/PROTECTED).....	4-12	Rev. 3
FIGURE 4-11 LEAD-LAG (PROTECTED ONLY).....	4-13	
FIGURE 4-12 LEAD-LAG (PROTECTED-PERMITTED).....	4-14	
FIGURE 4-13 QUAD SEQUENTIAL (PROTECTED ONLY)	4-16	
FIGURE 4-14 QUAD SEQUENTIAL (PROTECTED-PERMITTED)	4-17	
FIGURE 4-15 DUAL QUAD (PROTECTED ONLY)	4-18	
FIGURE 4-16 DUAL QUAD (PROTECTED-PERMITTED).....	4-19	
FIGURE 4-17 STANDARD OVERLAP	4-22	
FIGURE 4-18 NON-STANDARD OVERLAP (RIGHT-TURN WITHOUT CONFLICTING MOVEMENT)....	4-23	
FIGURE 4-19 RIGHT-TURN WITH CONFLICTING MOVEMENT (NOT AN OVERLAP).....	4-24	
FIGURE 4-20 SINGLE STAGE PHB CROSSING	4-26	
FIGURE 4-21 TWO STAGE PHB CROSSING.....	4-27	
FIGURE 6-1 CONFLICT POINTS	6-4	
FIGURE 7-1 DILEMMA ZONE TRAP CHECK (TWO DETECTORS)	7-4	Rev. 3
FIGURE 7-2 PLACEMENT OF LEFT-TURN LANE DETECTION	7-5	
FIGURE 7-3 LEFT-TURN LANE DETECTION	7-5	
FIGURE 7-4 PLACEMENT OF SIDE STREET DETECTION.....	7-6	
FIGURE 7-5 FIGURE 8 PATTERN BICYCLE LOOP.....	7-14	
FIGURE 7-6 BICYCLE BOX.....	7-14	
FIGURE 9-1 SAMPLE PRE-EMPTION SETTINGS BLOCK.....	9-4	
FIGURE 9-2 RAILROAD PRE-EMPTION TRACK CIRCUIT TIMING BLOCK	9-7	
FIGURE 10-1 TYPES OF VISIBILITY LIMITING DEVICES	10-4	
FIGURE 10-2 Y-TYPE SPAN SIGNAL SUPPORT	10-8	
FIGURE 10-3 MAST ARM ASSEMBLY PROFILE VIEW	10-15	

FIGURE 10-4 MAST ARM ASSEMBLY PLAN VIEW.....	10-16
FIGURE 14-1 LOCATING THE SIGN (INADEQUATE VISIBILITY TO A QUEUE).....	14-4
FIGURE 14-2 SEQUENTIAL PHASING WITH A “DUMMY” PHASE.....	14-5
FIGURE 14-3 LOCATING THE SIGN (INADEQUATE VISIBILITY TO SIGNAL HEADS)	14-9
FIGURE 14-4 QUAD PHASING WITH SIGN ON ONE ARTERY APPROACH.....	14-10
FIGURE 14-5 QUAD PHASING WITH SIGNS ON BOTH ARTERY APPROACHES	14-11
FIGURE 14-6 SEQUENTIAL PHASING WITH A “DUMMY” PHASE.....	14-12
FIGURE 15-1 COMMONLY USED CONDUIT.....	15-6
FIGURE 15-2 TRAFFIC SIGNAL CABLES.....	15-12
FIGURE 15-3 PRIVATELY OWNED POWER COMPANIES	15-13
FIGURE 15-4 MUNICIPAL OWNED POWER SERVICES	15-14
FIGURE 15-5 POWER COMPANY JURISDICTION IN CONNECTICUT	15-15
FIGURE 15-6 NORTHEAST UTILITIES DISTRICT OFFICES AND LOCATIONS.....	15-16
FIGURE 15-7 UTILITY POLE DATA	15-17
FIGURE 15-8 TYPICAL UTILITY POLE CONSTRUCTION	15-18
FIGURE 15-9 POLE-TO-POLE GUY	15-19
FIGURE 15-10 CALL-BEFORE-YOU-DIG COLOR CODE	15-21
FIGURE 15-11 SERVICE CONDUCTOR RESISTANCE	15-23
FIGURE 15-12 INTERCONNECT CABLE ATTACHMENT LIST	15-29
FIGURE 15-13 LOCATION NUMBERING SYSTEM	15-36
FIGURE 16-1 TYPICAL PHASE ASSIGNMENTS	16-2
FIGURE 16-2 SEQUENCE AND TIMINGS	16-3
FIGURE 16-3 SYSTEM INFORMATION BLOCKS.....	16-4
FIGURE 16-4 DESIGN INFORMATION BLOCKS	16-5
FIGURE 16-5 TRAFFIC CONTROL SIGNAL PLAN OFFICE RECORD	16-6
FIGURE 16-6 CONSTRUCTION NOTES SECTION	16-7
FIGURE 16-7 INTERSECTION LAYOUT	16-8
FIGURE 17-1 SIGNAL COORDINATION SYSTEM SELECTION WORK SHEET	17-4
FIGURE 17-2 SIGNAL SYSTEM CONCURRENCE SHEET	17-5
FIGURE 17-3 TIME SPACE DIAGRAM EXAMPLE	17-9
FIGURE 20-1 RECOMMENDED CLEAR ZONE DISTANCES.....	20-1
FIGURE 21-1 COMMONLY USED CONSTRUCTION NOTES	21-14

REFERENCES

1. "Traffic Signals: Capacity and Timing Analysis" by R. Akcelik, March 1981 Australian Road Research Board - Research Report ARR No. 123.
2. Connecticut Department of Transportation Highway Design Manual, latest edition.
Website: www.ct.gov/dot/
3. Highway Capacity Manual, Transportation Research Board, latest edition.
Website: www.trb.org/bookstore/
4. Highway Capacity Software, McTrans Center, University of Florida, Gainesville, Florida.
Website: www.mctrans.ce.ufl.edu/featured/
5. Manual of Traffic Signal Design – Institute of Transportation Engineers, latest edition.
6. Manual on Uniform Traffic Control Devices For Streets And Highways, US Department of Transportation Federal Highway Administration - latest edition.
Website: www.mutcd.fhwa.dot.gov/
7. NCHRP Synthesis 225 - "Left-Turn Treatments at Intersections" Transportation Research Board National Research Council, Washington, D.C. 1996.
Website: www.trb.org/bookstore/
8. National Electric Code - latest edition.
Website: www.nfpa.org/
9. National Electric Safety Code - latest edition.
Website: www.ieee.org/
10. NEMA Standards Publication No. TS-2 1992, Traffic Controller Assemblies.
Website: www.nema.org/
11. Public Roads Capacity Analysis Techniques for Design of Signalized Intersections, Reprinted from Public roads Vol. 34 No. 9 & 10 , August 1967 & October 1967, US Department of Transportation Federal Highway Administration.
12. Regulations of the Connecticut State Agencies Vol. II Section 16-243 -Construction and Maintenance Standards Governing Traffic Signals Attached to Public Service Company Poles.
Website: www.state.ct.us/dpuc/

13. Standard Specifications for Roads, Bridges and Incidental Construction - latest edition, Connecticut Department of Transportation, and supplement.
Website: www.ct.gov/dot/
14. State Traffic Commission Administrative Regulations - section 14-298-700 to 14-298-741.
Website: www.ct.gov/dot/
15. Traffic Control Systems Handbook FHWA – HOP – 06 – 006, Federal Highway Administration, Office of Transportation Management, October 2005.
Website: www.ops.fhwa.dot.gov/publications/publications.htm
16. Transportation and Traffic Engineering Handbook - fifth edition, Institute of Transportation Engineers.
17. Catalog of Signs – Connecticut Department of Transportation, latest edition.
18. CADD/Graphics/GIS Manual.
19. State of Connecticut, Department of Transportation, Bureau of Engineering and Highway Operations – Functional Specifications for Traffic Control Equipment, latest edition.
20. Transportation Quarterly – Signal Change Intervals and Intersection Geometry – January 1984, Volume XXXVIII, No. 1.
21. Consulting Engineer’s Manual, prepared by Bureau of Engineering and Construction, Office of Engineering, Division of Consultant Design – latest edition.

1 PRELIMINARY CONSIDERATIONS

Before a traffic control signal is designed it must be determined if the signal is warranted and needed through a review of the volumes, sight lines, accident experience, turning movements, geometry and input from local officials.

Once it is determined that a traffic control signal will be installed, it is necessary to perform preliminary analysis to determine geometry, lane arrangement and phasing. The geometric design of an intersection involves several critical decisions about the number and use of lanes to be provided on each approach. Factors to be considered include but are not limited to the functional classification of the roadway; the proximity of nearby signals; the degree of need for platoon cohesion; level of service and; volume to capacity ratios.

When installing or revising a traffic control signal, the designer must take into account the physical setting in which the signal will be located. Visiting the site to get a "feel for" the area is important so that the designer can understand the landscape and the community in which the design will have to assimilate. Sensitivity to the placement of appurtenances to minimize their aesthetic impact on adjacent development, particularly residential, should be considered. An effort should be made to limit environmental impacts while maintaining safety and mobility. The designer should always be cognizant of where signal equipment will be placed in relation to existing appurtenances. A survey may be needed to show above-ground and under-ground utilities. Also, test pits may be required depending on information from the survey. If the signal equipment cannot be located without potential utility conflicts, the designer should bring it to the attention of the Division of Traffic Engineering.

In some instances design criteria set forth by the Regulations of the State Traffic Commission (reference 14) are more stringent than those of the Manual on Uniform Traffic Control Devices (MUTCD) (reference 6). In those cases, the Regulations of the State Traffic Commission will govern.

2 DESIGN VOLUMES

In design projects, volumes are usually projected to some design year in the future, usually a 20 year projection. These future volumes should be used to determine traffic signal phasing, lane arrangements and storage length requirements. Signal timings and cycle length for these future volumes should also be evaluated to verify that proposed phasing and lane arrangements would remain valid. This information is also utilized in air quality analysis.

The traffic signal timings and cycle length needed for when the signal is first turned on should also be determined. These timings should be based on operational traffic volumes expected for approximately three years after completion of construction (five or more years after design). The 20 year traffic volumes should be adjusted to operational volumes by any appropriate method to provide for a.m., p.m., other peaks and off peaks, and appropriate timing plans should be included in the project.

Air Quality Assessment is required for projects where the anticipated level of service is D or worse. In those cases, localized carbon monoxide (CO) assessment must be conducted by the Bureau of Policy and Planning to determine air quality conformity.

3 INTERSECTION CHANNELIZATION DESIGN GUIDELINES

Left-Turn Lanes

1. Left-turn lanes should be considered to address **capacity concerns** or if land-use changes are expected to produce significant shifts in local traffic patterns such as increases in left-turn demand. Signalized capacity analysis procedures should be used to determine lane arrangements.
2. In terms of **safety**, left-turn lanes should be considered at intersection approaches that experience a significant number of accidents involving left-turning vehicles. Another safety application would be to include left-turn lanes where it is critical to protect queued left-turning vehicles from through traffic.
3. Left-turn lanes may also be considered based on **approach geometry**. One example of this would be at a location where the stopping sight distance to the intersection is limited. In this case it may be appropriate to include left-turn lanes regardless of demand volume. The provision of a left-turn lane under these conditions may help to reduce the potential for rear-end accidents.
4. In some cases left-turn lanes may be added without additional widening of the road by removing parking, narrowing lanes, or a combination of the two.
5. If left-turn lanes are provided on both approaches of the same road, it is preferable to locate them directly opposite each other. This allows the left-turning driver on each approach to view oncoming through traffic without obstruction by left-turning vehicles on the opposite approach.

Other Left-Turn Treatments

In some cases, the highway geometry and traffic characteristics prevent efficient operation of intersections with direct left-turns. Special solutions have been implemented to handle these situations. These include directional crossovers, jug handles and at-grade loops.

The intent of special design treatments is to eliminate the left-turn movement and its required signal phase, without prohibiting the actual movement. Traffic is diverted through the intersection as a right-turn or through movement, whereupon it completes the "left-turn" on a cross street again as either a right or through movement.

The operational advantages of these designs are that they enable simple phasing, thereby facilitating corridor signal progression schemes. Potential concerns with these applications relate to the weaving movement required in some cases and the result that "left-turn" traffic must go through the intersection twice.

Right-Turn Lanes

Right-turn lanes should also be considered to address **capacity concerns** or if land-use changes are expected to produce significant shifts in local traffic patterns such as increases in right-turn demand. Signalized capacity analysis procedures should be used to determine lane arrangements.

Dual Turn Lanes

The use of a dual or double turning lane either on two exclusive lanes or on one exclusive lane and a second combination lane should be considered when:

- There is not sufficient space to provide the calculated length of a single turn lane;
- The calculated length of a single turn lane becomes prohibitive;
- The necessary time for a protected left-turn phase becomes unattainable to meet the level-of-service criteria (average delay per vehicle); or
- The volume to capacity ratio is greater than or equal to 0.90.

Dual right-turn lanes do not work as well as dual left-turn lanes because the drivers are positioned on the opposite side of the vehicle from the turn which tends to restrict their view of the turn area. If practical, the designer should find an alternative means to accommodate the high number of right-turning vehicles. For example, a turning roadway may accomplish this purpose. Dual left-turn or right-turn lanes onto an expressway entrance ramp should be discouraged because of the potential negative impact on expressway operations.

Dual turn lanes (both lanes exclusive) can potentially discharge approximately 1.9 times the number of cars that could discharge from a single exclusive turn lane. However, to work properly, several design elements must be carefully considered. **Figure 3-1** presents both dual left-turn and right-turn lanes to illustrate the more important design elements. The designer should consider the following:

Throat Width

Because of the off-tracking characteristics of turning vehicles, the normal width of two travel lanes may be inadequate to properly receive two vehicles turning abreast. Therefore, the receiving throat width may need to be widened. For 90-degree intersections, the designer can expect that the throat width for dual turn lanes will be approximately 30-36 feet (9 - 11 m). If the angle of turn is less than 90-degrees, it may be acceptable to provide a narrower width. When determining the available throat width, the designer can assume that the paved shoulder, if present, will be used to accommodate two-abreast turns. It is also highly desirable to have a center island on the receiving leg of the turn, to provide good definition of the entry throat area.

Acceptance Carry Through Length

There should be an adequate length of two lanes provided on the downstream section of road receiving the double turn movement to safely merge back to a single lane. The Department's Highway Design Manual (reference 2) should be used for preliminary design purposes. A common practice in determining the length of carry through is to provide a length equal to twelve times the green interval allotted to the movement. In this case, the carry through length should be measured from the point where the turning vehicles have completed their turn maneuver and not from the stop bar.

Widening Approaching Through Lanes

If a 30 foot (9 m) or 36 foot (11 m) throat width is provided to receive dual turn lanes, the designer should also consider how this will affect the through traffic approaching from the other side. See **Figure 3-1**. The designer should also ensure that the through lanes line up relatively well to ensure a smooth flow of traffic through the intersection.

Special Pavement Markings

As illustrated on **Figure 3-1**, special pavement markings can effectively guide two lines of vehicles turning abreast. The guide markings are terminated when the turning movements are sufficiently oriented on the receiving through lanes. The Division of Traffic Engineering will help determine the selection and placement of any special pavement markings.

Signal Indications

Dual turn lanes provide for major traffic movements and require two signal faces.

Opposing Left-Turn Traffic

If simultaneous opposing left-turns will be allowed, the designer should ensure that there is sufficient space for all turning movements. This is always a factor, but dual left-turn lanes can cause special problems. If space is unavailable, it may be necessary to alter the signal phasing to allow the two directions of traffic to move through the intersection on separate phases.

Turning Templates

All intersection design elements for dual turn lanes must be checked by using the applicable turning templates.

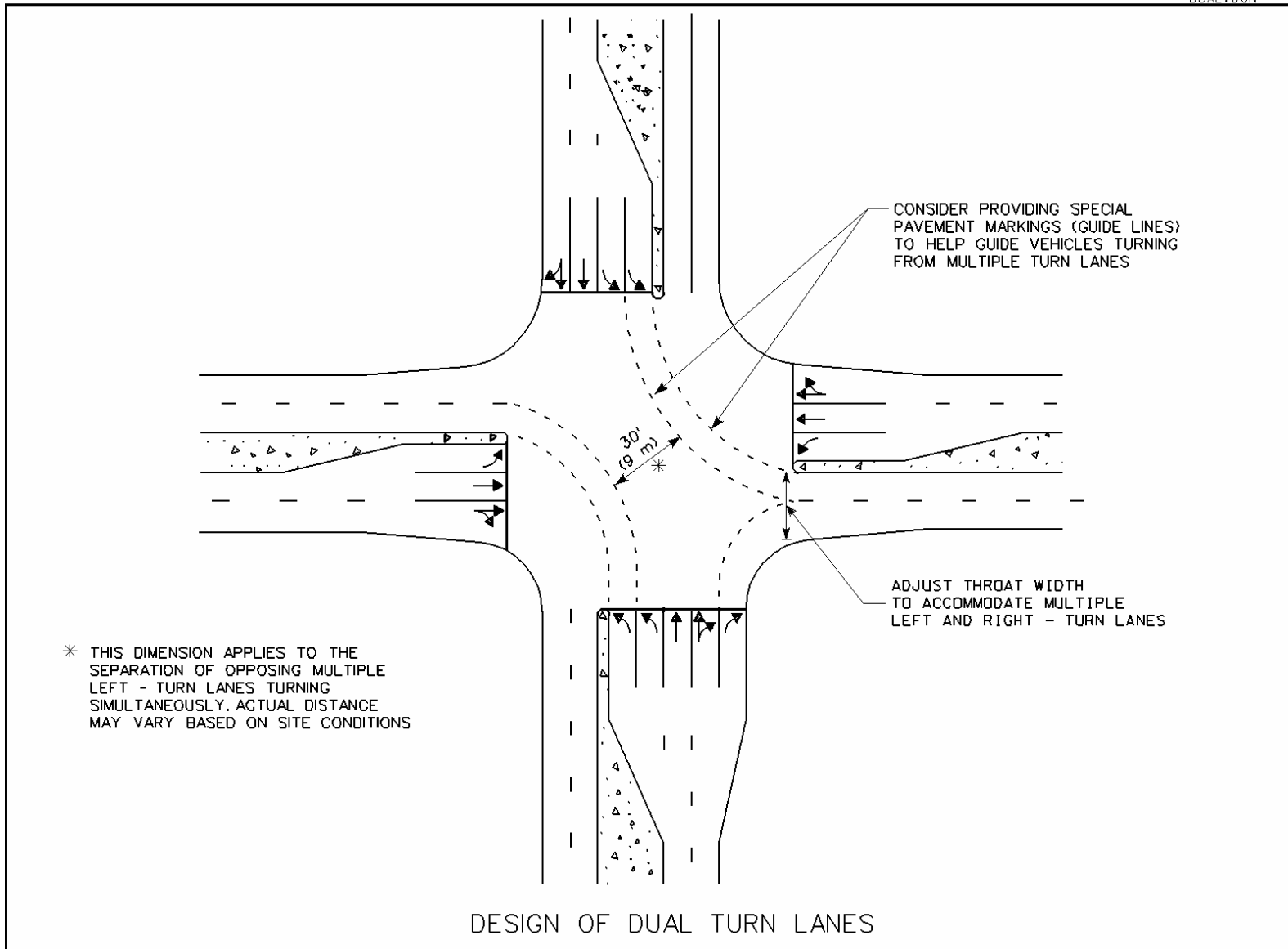

Figure 3-1 Design of Dual Left-Turn Lanes

4 PHASING

Phasing Sequences

General

The simplest and most common type of phasing is a two-phase operation with a phase for the artery and another for the cross street. The left-turn movements must yield to opposing traffic, turning only when there is an adequate gap.

The figures in this section represent typical signal face numbering convention for the respective scenario. A phasing diagram shall be provided on all signal plans. Technical notes should be limited only to situations where additional clarification is needed.

Refer to [Chapter 4D \(Traffic Control Signal Features\)](#) of the *Manual on Uniform Traffic Control Devices (MUTCD), 2009 Edition* ([reference 6](#)) for selection of signal face options.

NEMA Ring Diagrams

The controller unit (CU) is specified to meet the *National Electrical Manufacturers Association (NEMA) Standards TS2* ([reference 10](#)). Although the CU can be programmed to provide a variety of phasing configurations, the Department uses four basic sequences shown in **Figure 4-1**, **Figure 4-2**, **Figure 4-3**, and **Figure 4-4**. Most intersections owned and maintained by the Department are designed as one of these. Typical phase assignments are as follows:

- Phase 1 is an artery left-turn phase.
- Phase 2 is an artery through phase.
- Phase 3 is typically used for a pedestrian phase or a side street left-turn phase.
- Phase 4 is a side street through phase.
- Phase 5 is an artery left-turn phase.
- Phase 6 is an artery through phase.
- Phase 7 is a side street left-turn phase.
- Phase 8 is a side street through phase.
- Phase 9 is a pedestrian phase only used in dual ring, dual quad operation.

Sequence #1: Single Ring Operation

This is the most common sequence. One phase is serviced at a time and must terminate before another becomes active.

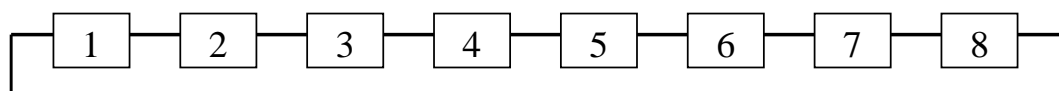

Figure 4-1 NEMA Single Ring Diagram

Sequence #2: Dual Ring Operation, Quad/Sequential

This is the most common dual ring sequence. It is usually used for an arterial quad left-turn.

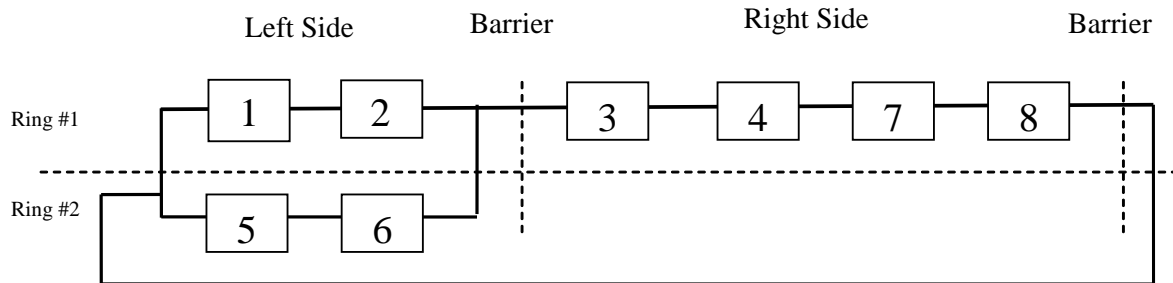

Figure 4-2 NEMA Dual Ring, Quad/Sequential Diagram

Sequence #3: Dual Ring Operation, Dual Quad (Quad Left-turn)

At applicable intersections, this sequence provides the most efficiency. It allows each phase to time concurrently with two other non-conflicting phases under the restraint of the barrier.

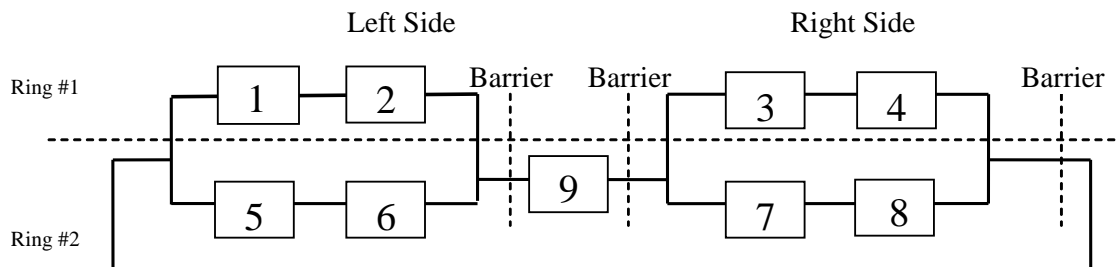

Figure 4-3 NEMA Dual Ring, Dual Quad (Quad Left-turn) Diagram

Sequence #4: Dual Ring Operation, Sequential/Quad

Of the four sequences this is used least. With it, the advantages of a quad left-turn may be applied to the side street movements.

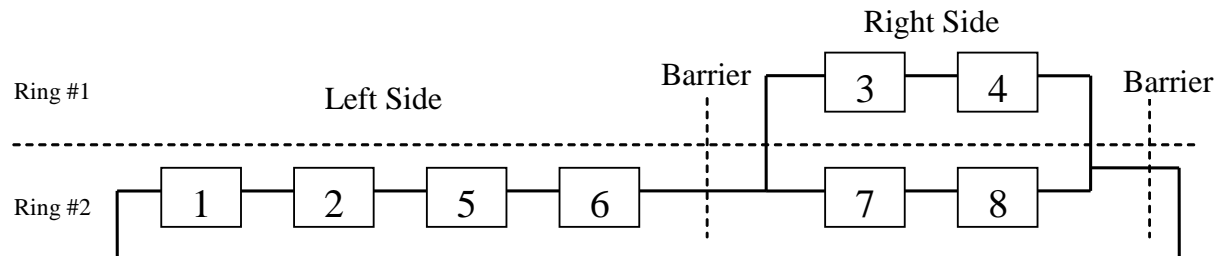

Figure 4-4 NEMA Dual Ring, Sequential/Quad Diagram

Left-Turn Display Options

General

Left-turning traffic causes more conflicts than any other vehicular movement. As a result, left-turn phasing is the most commonly added phase to a two-phase operation. The identification of such a conflict may be obtained through crash analysis or capacity analysis. The selection of any combination of lane assignments or signal treatments should be based upon the overall effectiveness of the control schemes available. These conflicts can be treated in a number of ways. The objective of any treatment is an increase in capacity, a decrease in crash potential, or a combination of both.

There are five options for the left-turn phasing at an intersection:

- Permitted only
- Protected only
- Protected-permitted
- Split phasing
- Prohibited

Permitted Only Phasing

A permitted only operation allows two opposing approaches to move concurrently, with left-turns allowed after yielding to conflicting traffic and pedestrians. Circular green indications are displayed during permitted phasing. See **Figure 4-5** for the signal indication displays for this type of phasing.

Advance Green Protected Only Phasing

A protected only operation is a sequence in which left-turning vehicles from one approach are allowed to move together with the through traffic on that approach, but then not be permitted to move during the opposing through phase that follows.

To implement this type of phasing, an exclusive left-turn lane is required. A green left arrow indication is displayed to control the left-turn movement. The protected left-turn advance phase is terminated by the display of a yellow left arrow indication followed by a red left arrow indication on the left-turn signal assembly. See **Figure 4-6** for the signal indication displays for this type of phasing.

Advance Green Protected-Permitted Phasing

A protected-permitted operation is a sequence in which left-turning vehicles from one approach are allowed to move together with the through traffic on that approach while the opposing traffic is stopped and then are permitted to move during the opposing through phase that follows.

A green left arrow indication and circular green indication are displayed on the left most signal assembly. The protected left-turn phase is terminated through the display of a yellow arrow and a circular green indication simultaneously. The advance left-turn phase can be either fixed time or actuated. See **Figure 4-7** for the signal indication displays for this type of phasing.

This type of phasing is preferable with the provision of an exclusive left-turn lane, but may also be used without an exclusive left-turn lane. If used without an exclusive left-turn lane, detection may be provided on the other side of the centerline such that the wheel path of a left turning vehicle will pass through the detection zone to extend the left-turn phase (see Chapter 7).

Split Phasing

Split phasing represents an assignment of the right-of-way to all movements of a particular approach followed by all movements of the opposing approach. Split phasing may be necessary when the intersection geometry results in conflicting vehicle paths through the intersection, such as interlocking left-turns, where left-turning vehicles would have to occupy the same space to complete their turns.

A green left arrow indication and circular green indication are displayed on the left most signal assembly. The phase is terminated with the display of a circular yellow indication. See **Figure 4-8** for the signal indication displays for this type of phasing.

Single Point Urban Interchange (SPUI)

A SPUI is a type of highway interchange design created in order to help move large volumes of traffic through limited amounts of space safely and efficiently. It is similar in form to a diamond interchange but has the advantage of allowing opposing left turns to proceed simultaneously by compressing the two intersections of a diamond into one single intersection over or under the free-flowing road. An example of a SPUI's traffic signal design can be viewed at Intersection No. 144-201, which is located in the town of Trumbull. Please note that a more conventional SPUI signal design would likely utilize quad phasing for the artery approaches and channelized right turns from the off ramps that are not included in the signal operation.

Prohibited Left-Turns

Prohibition of left-turns on an approach is an option that may be implemented in some cases to maintain mobility at an intersection. In this case, a sign shall be provided that indicates "No Left Turn". In certain circumstances, a vertical arrow indication may be used.

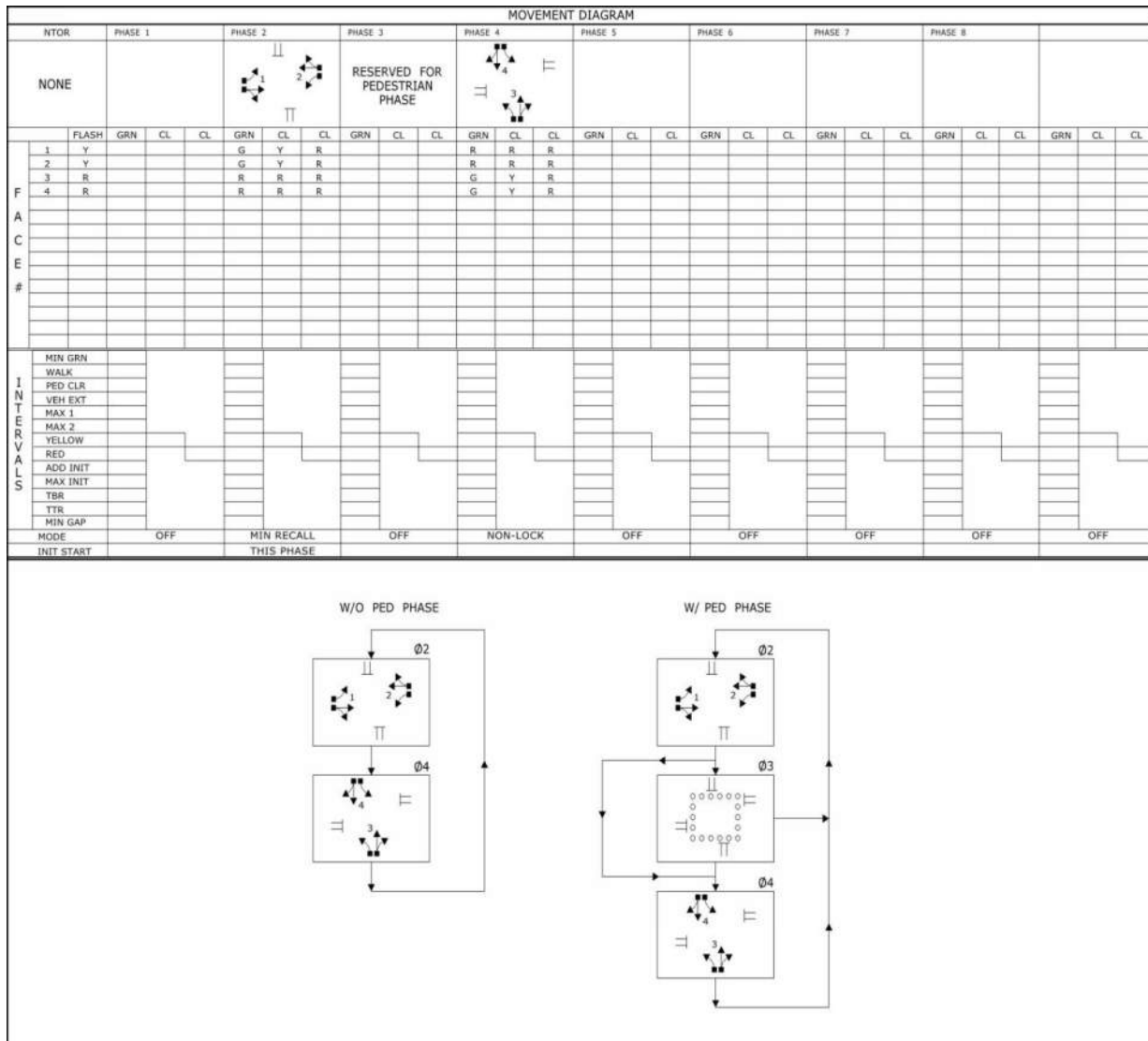

Figure 4-5 Permitted Only Phasing

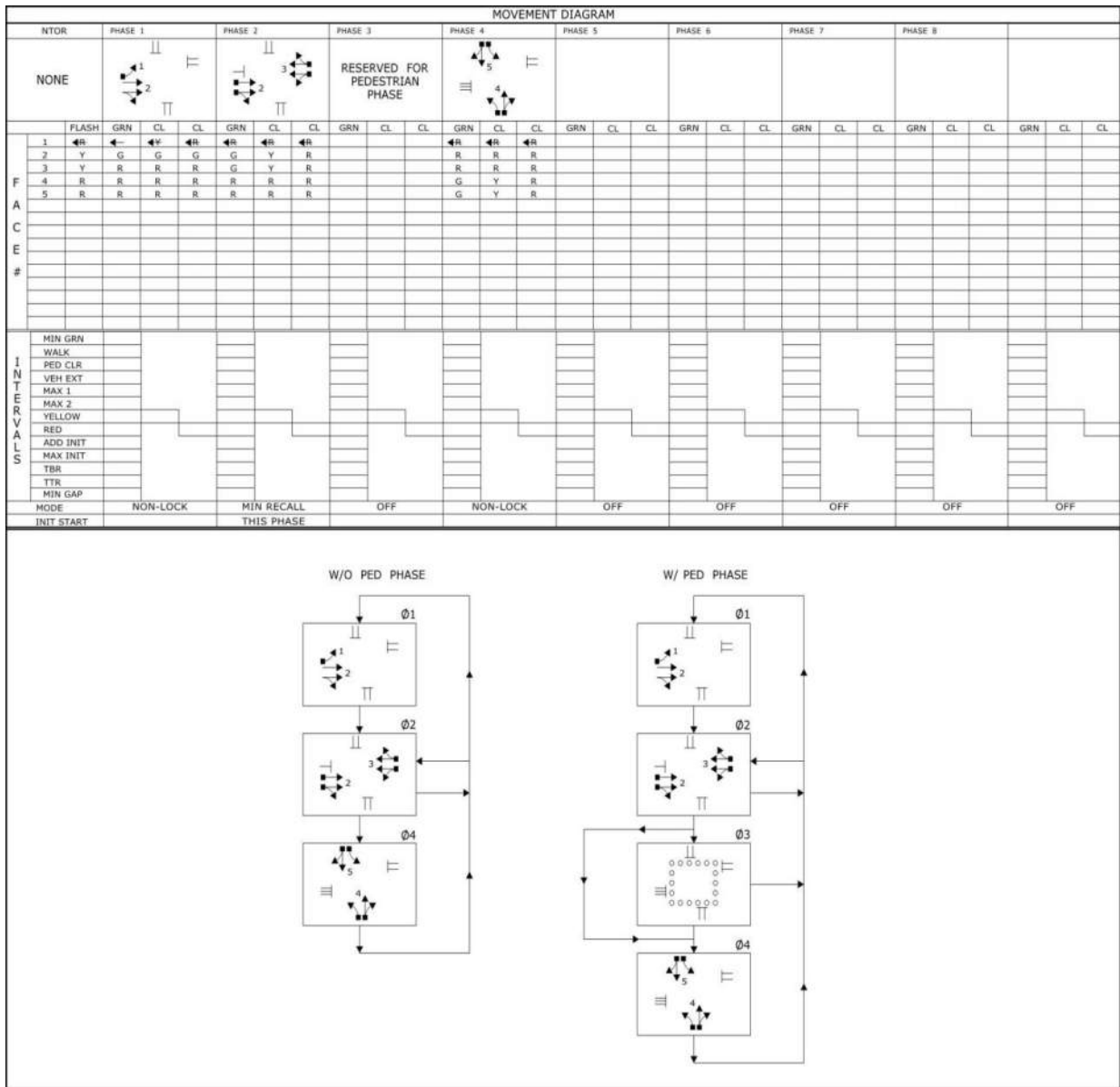

Figure 4-6 Advance Green (Protected Only)

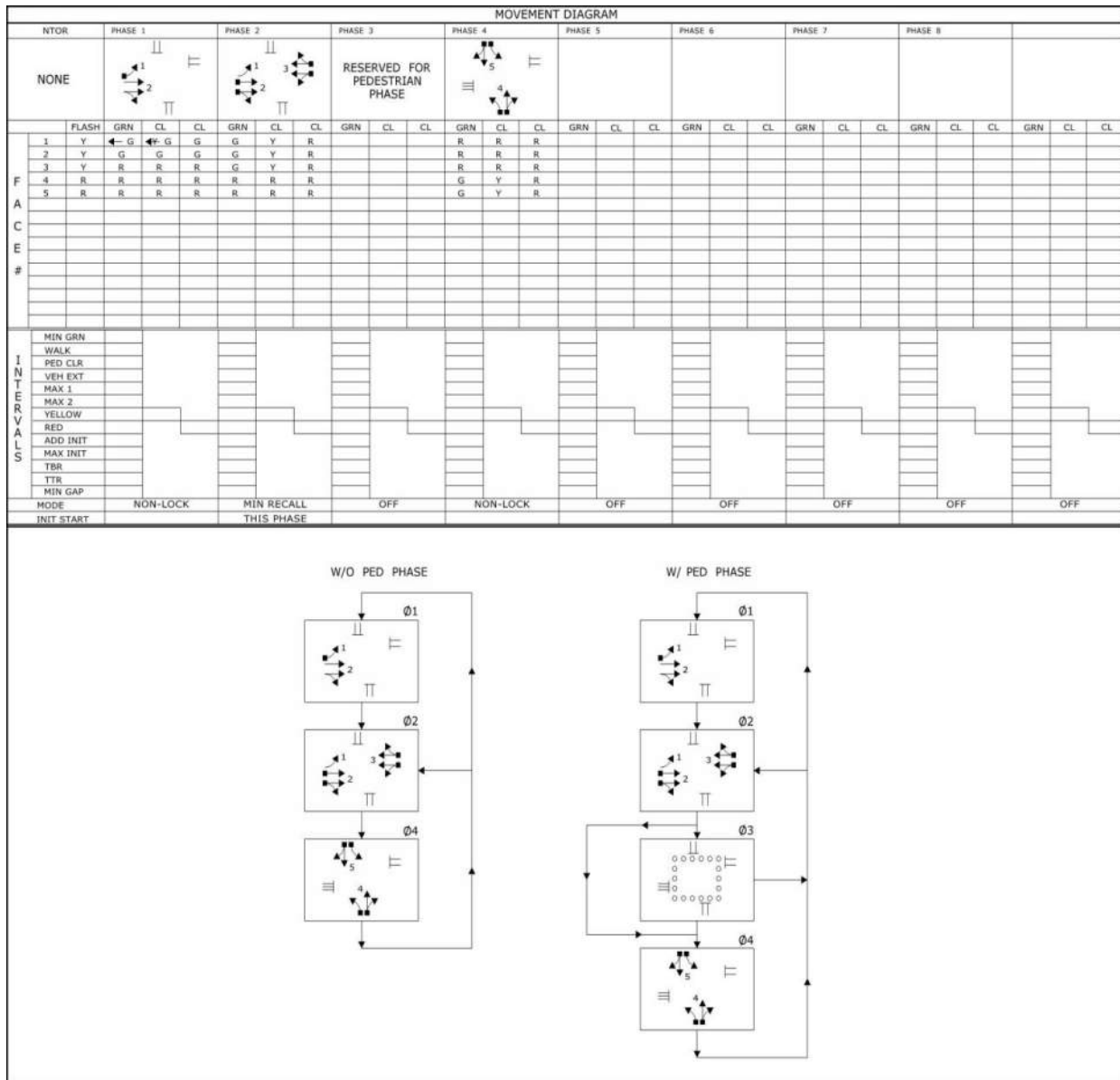

Figure 4-7a Advance Green (Protected/Permitted)

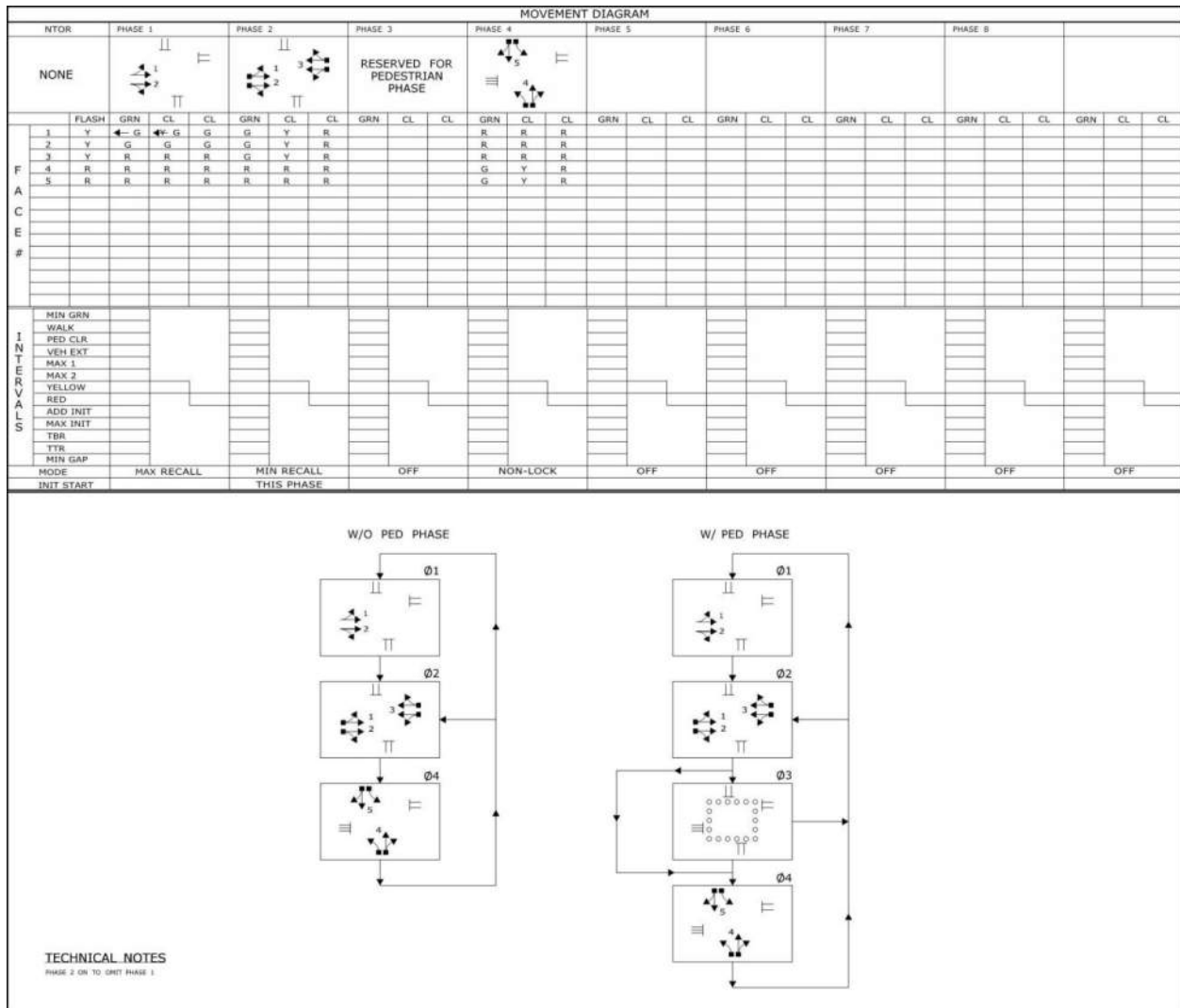

Figure 4-7b Advance Green (Fixed Advance)

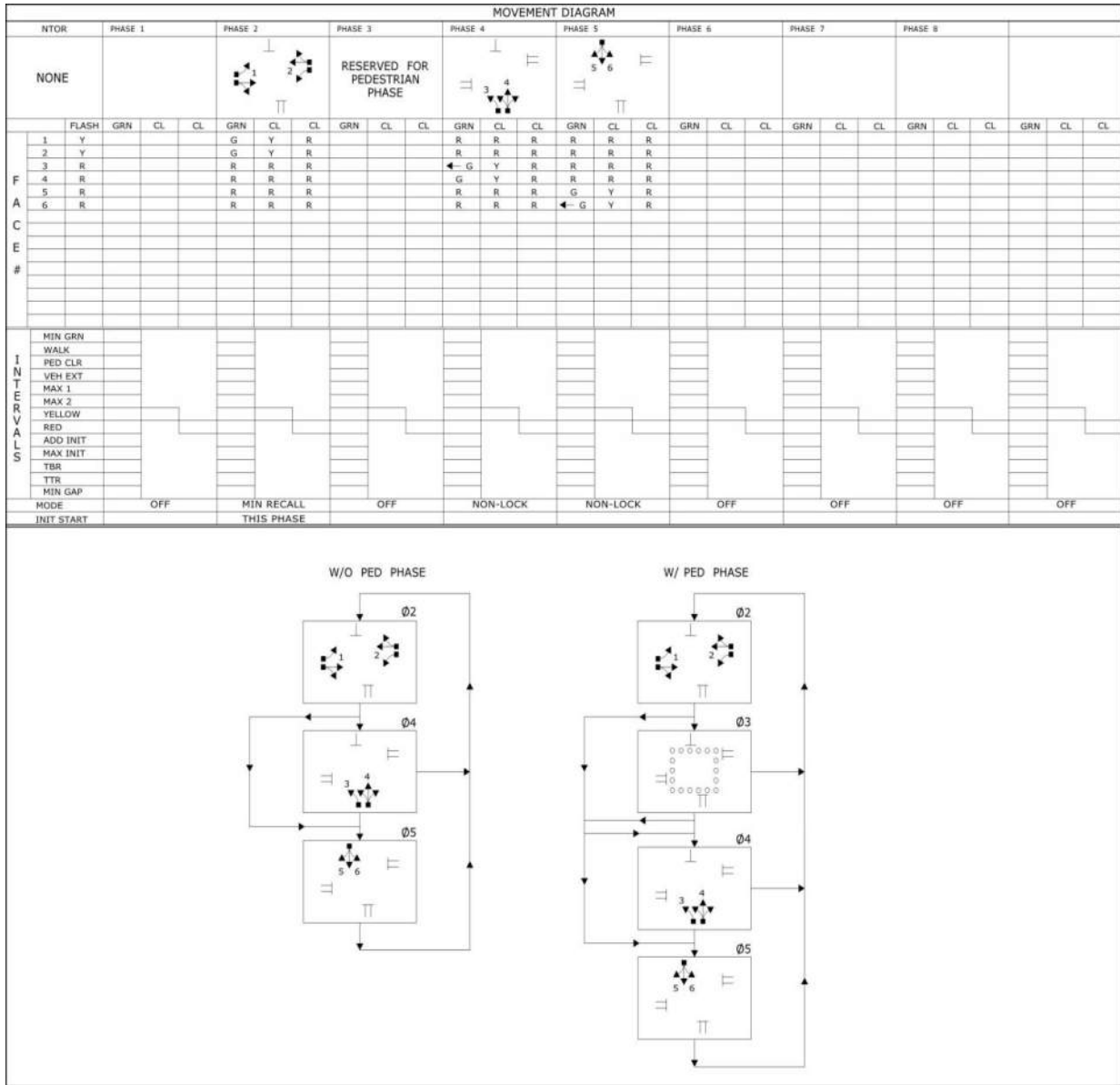

Figure 4-8 Split Phasing

Lag Green Signal Phasing

General

Lag green phasing is a sequence in which left-turns and through traffic in one direction is allowed to move protected from the opposing through traffic following the green phase for the through traffic. Lag phasing may operate in either a protected-only mode or in a permitted/protected mode.

Discretion should be used with lag phasing as it can introduce operational concerns. By far the most critical of these concerns involves driver expectancy. Ordinarily, the left-turning driver facing a yellow indication will expect the opposing through traffic to also have a yellow indication and that the through traffic will be stopping. Therefore, the driver believes that the turn can be completed on the yellow indication or immediately after. Since through traffic is not stopping, a potentially undesirable condition exists. At intersections where this operation occurs, an overhead “Oncoming Traffic Has Extended Green” sign shall be installed. At intersections where this operation may occur, an overhead “Oncoming Traffic May Have Extended Green” sign shall be installed. The potential conflict does not occur at “T” intersections, at diamond interchanges, and at locations with opposing protected-only left-turn phasing.

Additional information regarding lag phasing can be found in the *ITE Manual of Traffic Signal Design* ([reference 5](#)).

Protected Only Lag Green Phasing

A protected-only lag green phase requires an exclusive left-turn lane and indication. Termination of the lag green phase is accomplished with the display of a yellow left arrow indication followed by a red left arrow indication. See **Figure 4-9** for the signal indication displays for this type of phasing. This type of phasing should only be used in special cases.

Permitted/Protected Lag Green Phasing

Permitted/protected lag green phasing does not require an exclusive left-turn lane to implement. A permitted/protected lag green phase is terminated with the display of a circular yellow indication followed by a circular red indication which is the display provided to the through traffic on the same approach as the lag. See **Figure 4-10** for the signal indication displays for this type of phasing.

Lead-Lag Green Phasing

Lead-lag green phasing consists of an advance green phase in one direction, followed by the through movements, followed by a lag green phase in the opposite direction. This type of phasing is sometimes used to accommodate through movement progression in a coordinated signal system or interlocking left-turns. See **Figure 4-11** for signal indication displays for protected only lead-lag phasing. See **Figure 4-12** for signal indication displays for protected/permitted lead-lag phasing.

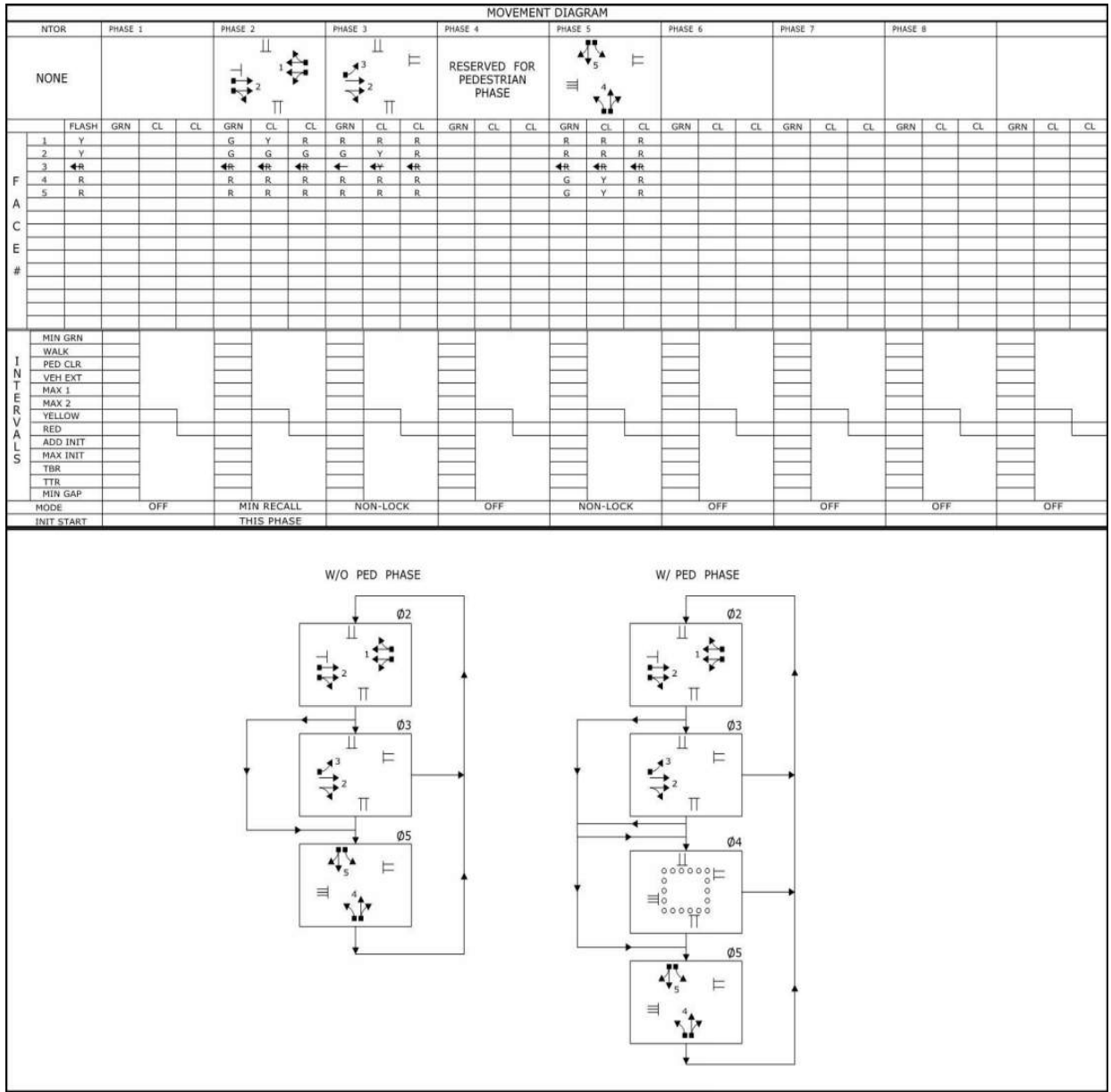

Figure 4-9 Lag Green (Protected Only)

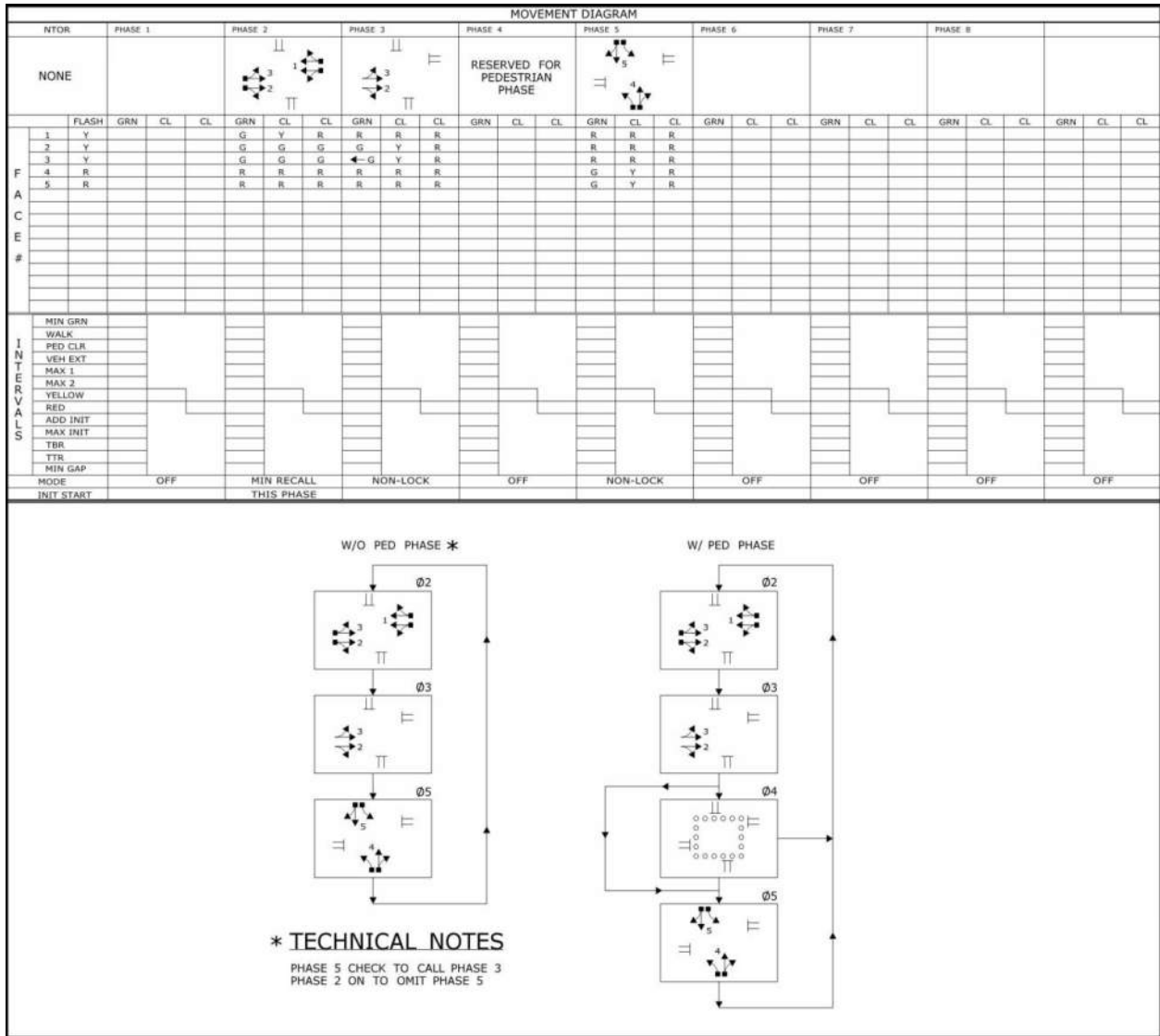

Figure 4-10 Lag Green (Permitted/Protected)

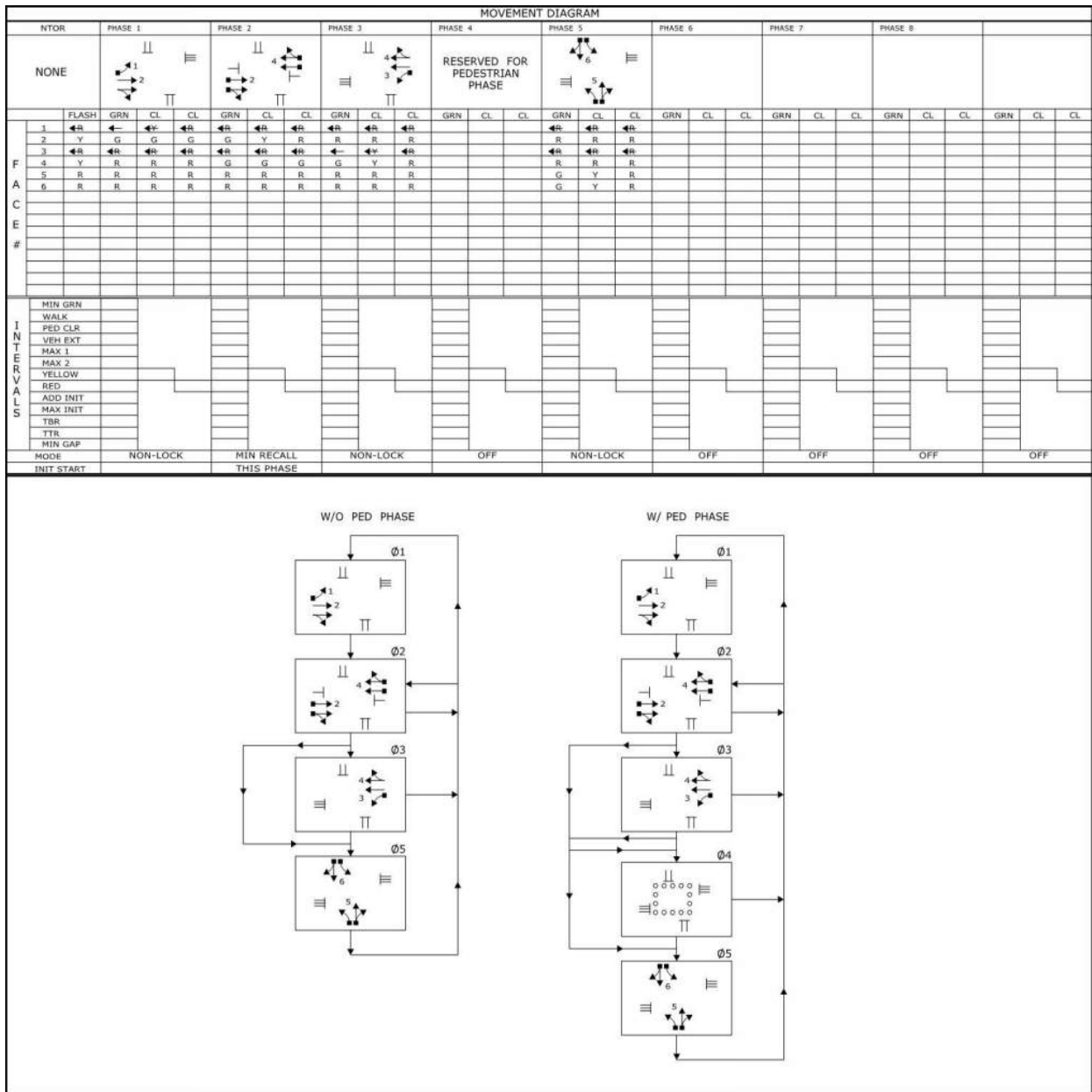

Figure 4-11 Lead-Lag (Protected Only)

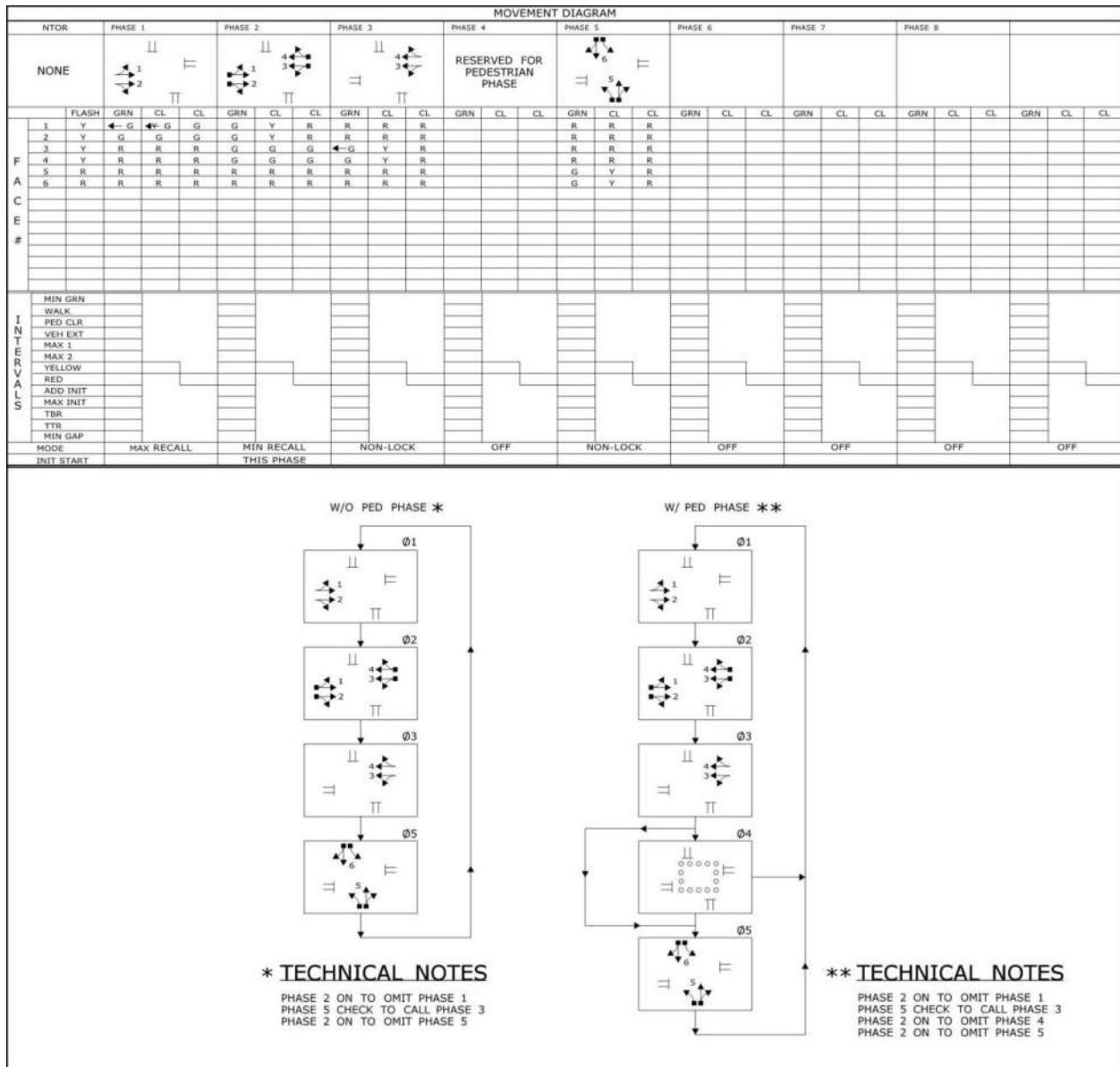

Figure 4-12 Lead-Lag (Protected-Permitted)

Quad Signal Phasing

General

In quad signal phasing, each vehicle movement operates as a separate phase which times concurrently but independently with other non-conflicting phases. Opposing left-turns start simultaneously as a dual advance. When left-turn vehicular demand is met in one direction, termination of that left-turn occurs and the opposing left-turn continues along with the adjacent through movement. When the remaining left-turn volume is satisfied or reaches its maximum allotted green time, termination of that left-turn green arrow occurs and the through movement in the direction of the lighter left-turn begins. This phasing is generally the most effective left-turn signal phasing because of its responsiveness to wide variations in left-turn volume.

Quad (multi ring) signal phasing is typically programmed into the CU as dual entry operation. With this type of operation, during low traffic periods, a side street signal phase may be unnecessarily serviced when there are no vehicles present. For example, one vehicle calls Phase 3. No other calls are made on Phases 7, 4, & 8. The CU will transfer to Phases 3 & 8 and then to Phases 4 & 8 before transferring to the front-side quad (Phases 1, 2, 5, & 6). The Phase 4 Min Green time is then wasted. The engineer has the option to skip either Phase 4 or 8, if not actuated, unless the signal is part of a coordinated (closed loop or time-based) system. If this option is chosen, Phases 4 & 8 should be shown as capable of being skipped in the flow diagram and the Phase 3 & 7 red clearance interval times should be calculated to reflect the possibility of these phases being skipped. Caution should be exercised in using this option as it may violate driver expectancy. As previously mentioned, coordinated signals shall not be allowed to skip Phases 4 & 8 of the back-side quad.

If it is determined through capacity analysis that dual-quad operation is required and an exclusive pedestrian phase is necessary, a “9-phase” operation is available. The pedestrian phase is serviced after the controller leaves the left-side barrier Phases 2&6. The pedestrian phase and timings are shown on the signal plan as Phase 9. Phase 9 should be shown after Phases 2 & 6 in the phasing diagram.

An intersection with this type of “9-phase” sequence cannot be coordinated in a closed loop system. This is discussed in Chapter 17 (Signal Systems) of this manual.

The signal indication displays for quad type phasing are shown on **Figure 4-13** through **Figure 4-16**.

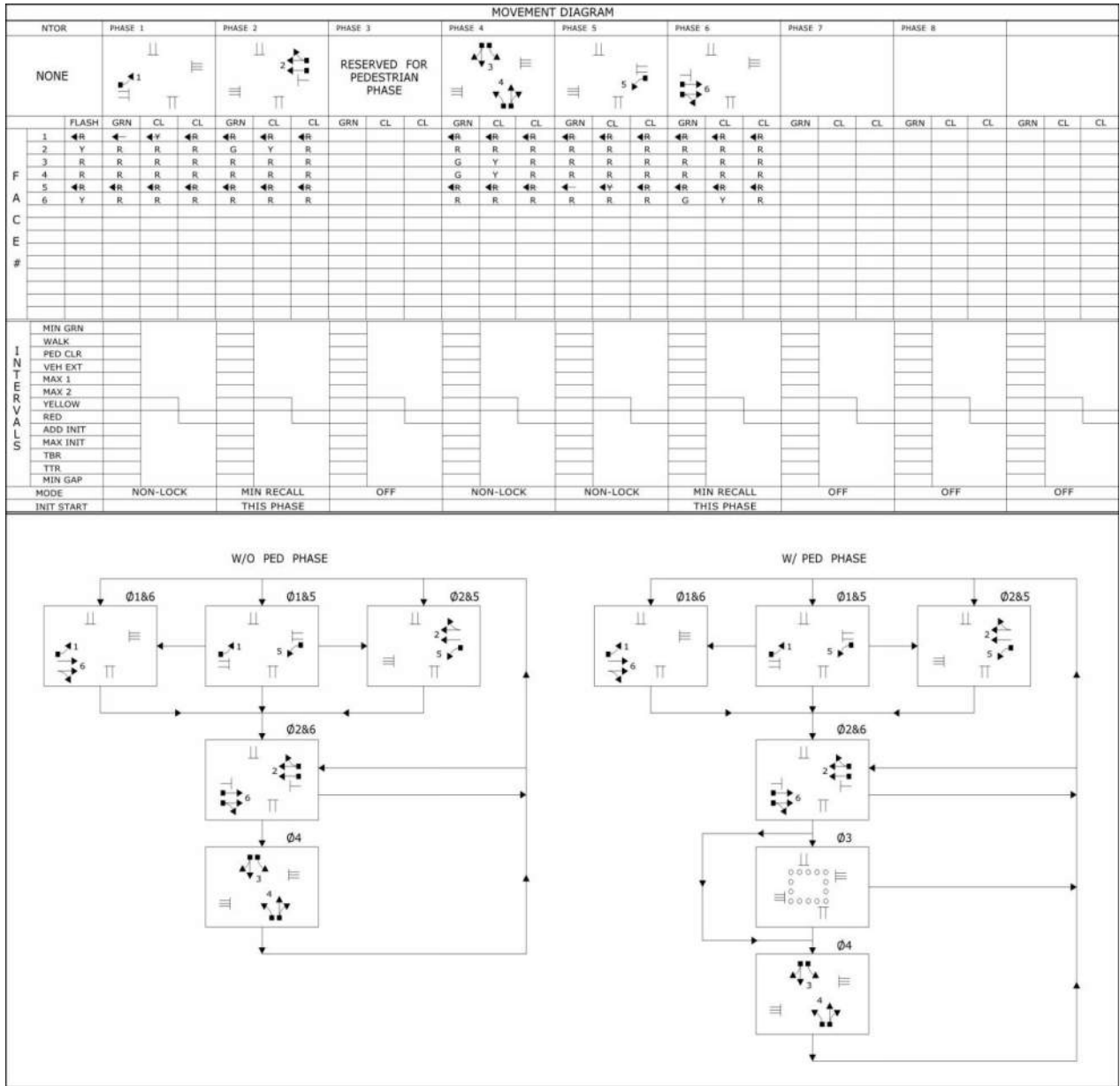

Figure 4-13 Quad Sequential (Protected Only)

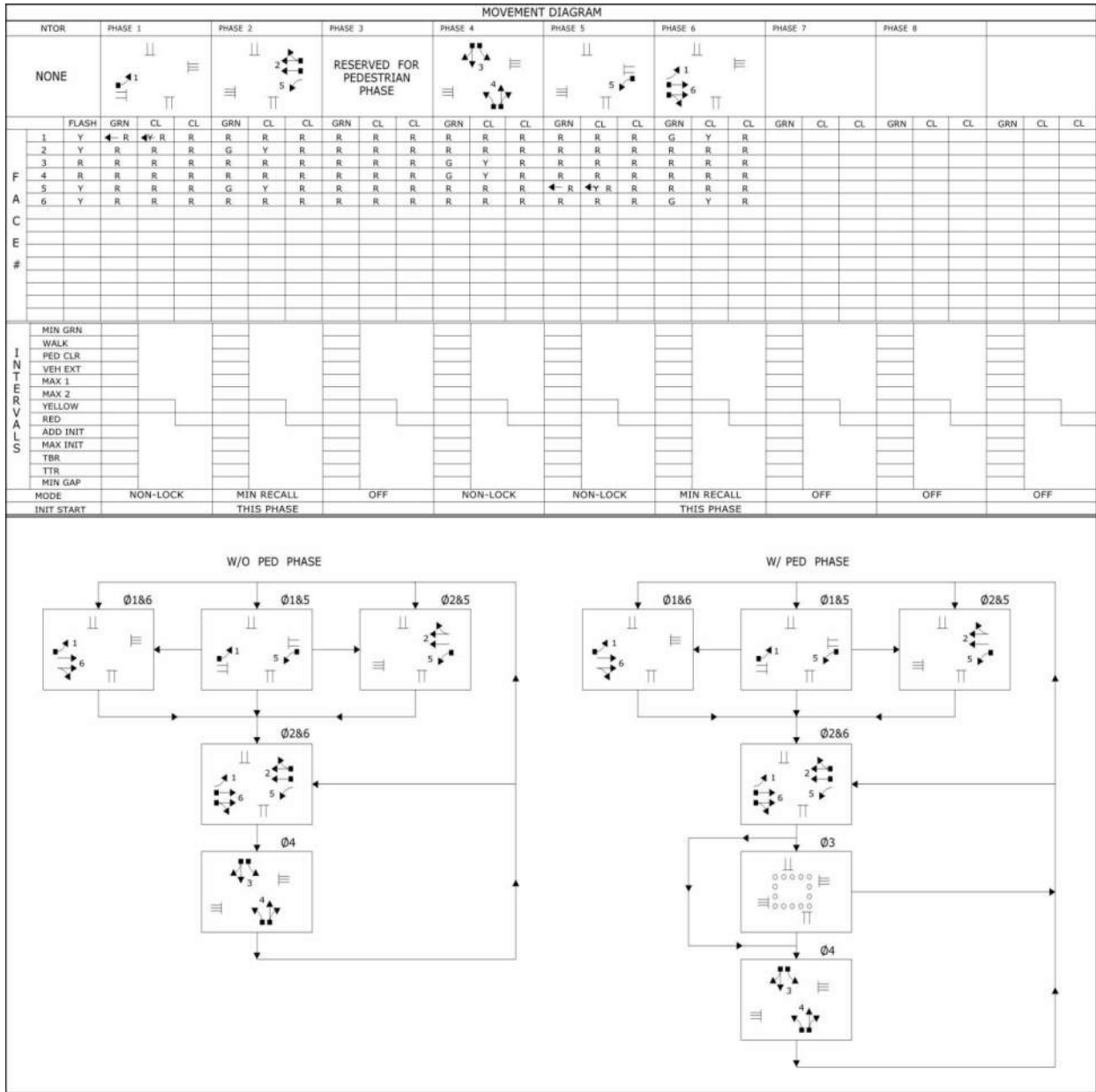

Figure 4-14 Quad Sequential (Protected-Permitted)

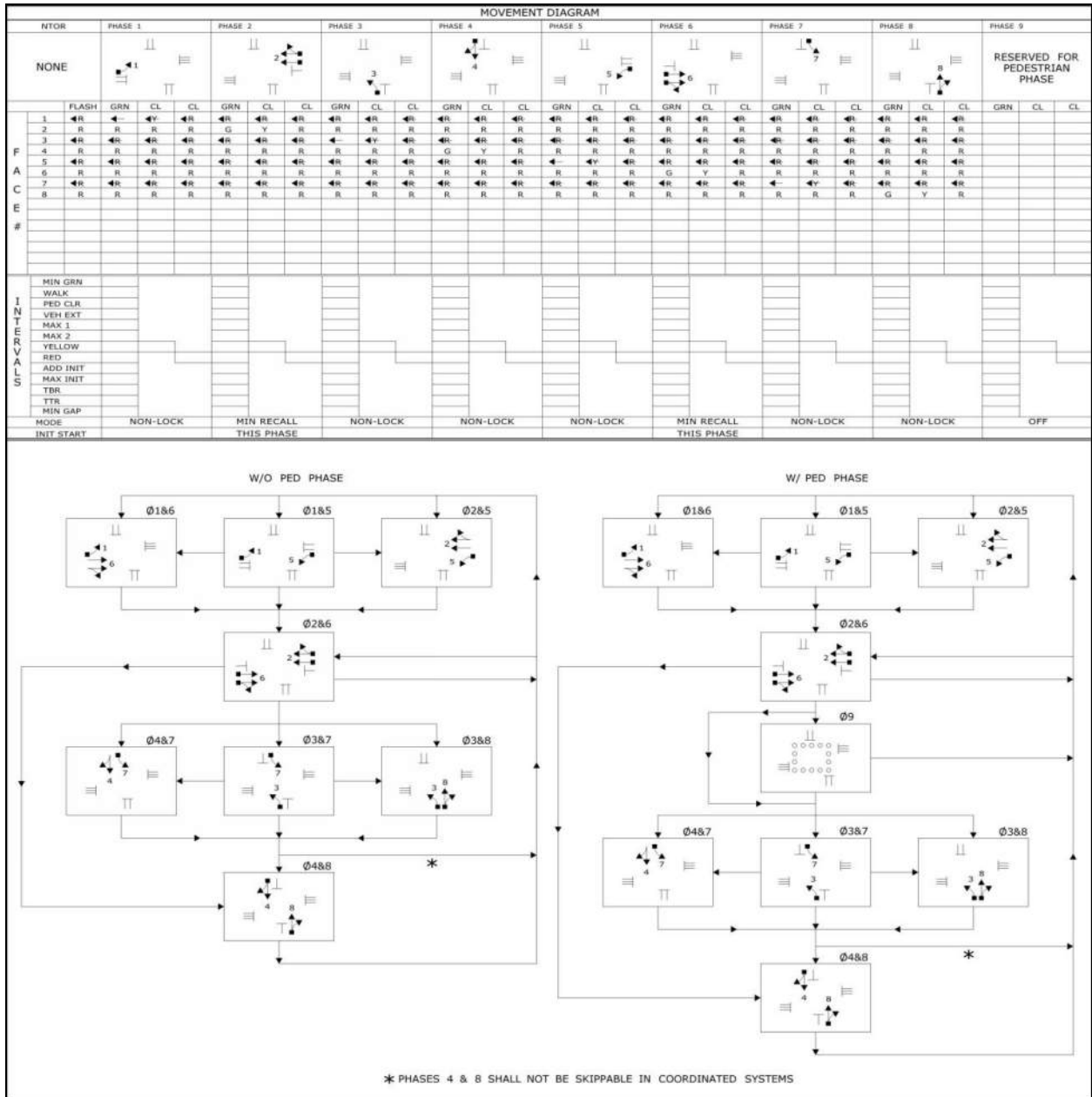

Figure 4-15 Dual Quad (Protected Only)

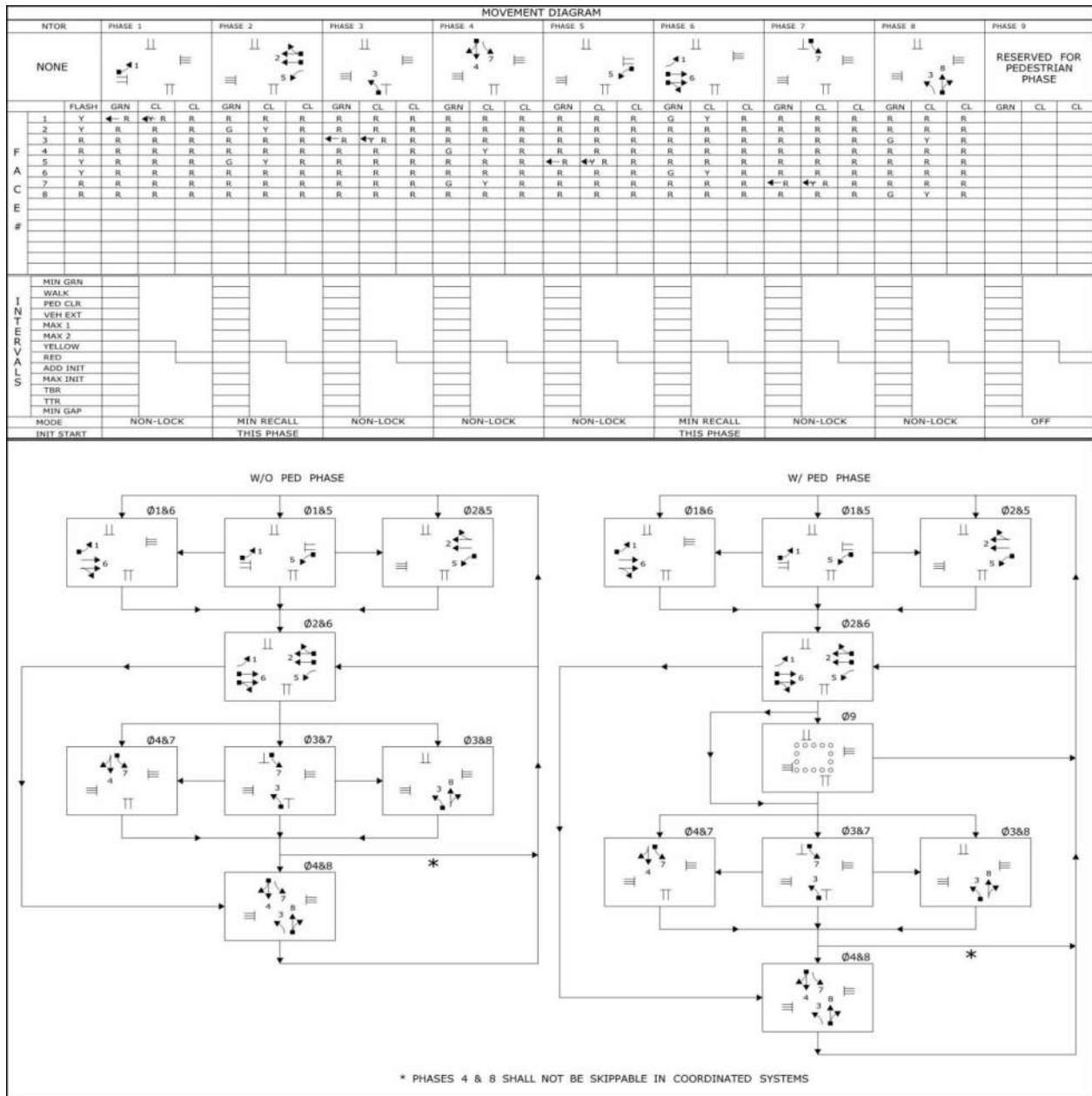

Figure 4-16 Dual Quad (Protected-Permitted)

Overlaps

General

An overlap is a green indication that allows traffic movement during the green intervals and clearance intervals between two or more phases. It is important to understand that an overlap is not a phase but rather a combination of phases. The green, yellow, and red indications are driven by the CU overlap outputs rather than one of the standard eight phase outputs. The overlaps do not have detector inputs. An overlap green indication is extended whenever one of the parent phases is extended. The overlap clearance times are from the parent phase that is terminating. When overlaps are used, the clearances are shown on the plan as if no phases are skipped (all phases are called). The number of overlaps should be limited to four; if additional overlaps are desired, the Signal Lab shall be contacted in order to ensure the controller will be adequate.

Overlaps are used in many ways such as a flashing sign clearance, an inside clearance or a pre-emption movement which is not in the normal sequence. The most common overlaps are advance approach and right-turn. An overlap is also used in the lag green phasing. Overlaps are standard or non-standard depending on its function.

Standard Overlaps

In a standard overlap the green, yellow, and red indications on the signal face are the same as the green, yellow, and red overlap outputs from the CU. There are usually no arrows in the signal face driven by the overlap. The overlap clearance indications cannot be misinterpreted. Refer to **Figure 4-17**. The Face 1 green arrow and yellow arrow are Phase 1 outputs. The Face 1 & 2 circular green, yellow, and red is a standard overlap of Phase 1 & 2 (the faces remain green from Phase 1 to Phase 2). The Technical Note “Standard Overlap Skip Features Apply” should be used. Additional technical notes to clarify the sequences are not necessary. Examples of typical standard overlaps include:

- Advance approach (the through movement associated with an advance left-turn)
- Non-actuated lag phases
- “Dummy” phases associated with flashing message signs
- Internal clearance phases between closely spaced intersections operating on one controller

Non-Standard Overlaps

In a non-standard overlap, the green, yellow, and red overlap outputs are altered by circuitry external to the CU to provide the sequence desired. The number of non-standard overlaps is limited to four when using State controllers meeting current specifications. Examples of typical non-standard overlaps include:

- Right-turn overlaps
- On/Omit pre-emption phases

The right-turn overlap is a phasing operation in which the right-turn movement of an approach has a green arrow and moves continuously through the phase clearances and/or concurrently with another phase such as a non-conflicting advance left-turn. Right-turn overlaps may be used where exclusive right-turn lanes exist except when the following conditions occur:

- Pedestrian conflicts
- Conflicts with u-turns
- Engineering judgement indicates a conflict may be created by curb cuts in the receiving lane downstream of the intersection
- Engineering judgement indicates that downstream platoon metering may be required

A right-turn green arrow overlap does not remain on during all phases of the overlap program. Occasionally the yellow and red indications are not displayed either. A green arrow shall not be displayed when said movement is in conflict with other vehicles moving on a green or yellow signal indication or with pedestrians crossing in compliance with a walking person (symbolizing WALK) or flashing upraised hand (symbolizing DON'T WALK) signal indication. Refer to the right-turn overlap in the sequence of **Figure 4-18** and the normal operation (not an overlap) in the sequence of **Figure 4-19**.

Moving the right-turn volume in the overlap phase should reduce the green time needed for the side street. The intersection geometry should be conducive to allow the overlap feature. Separate turn lanes of adequate length, appropriate corner radii, and proper lane width should be provided. Although a continuous right-turn flow is generally desirable, right-turn-on-red can accommodate significant volumes without an overlap green arrow.

The placement and use of detectors for this type of operation deserves careful consideration, including a detailed analysis of turning volumes:

1. Detectors can be provided for the artery left-turn lane only. This would then provide side street right-turns extra time to move and accommodate the side street right-turning traffic that was not handled by the side street phase.
2. Detection can be provided for the artery left-turn lane and the side street right-turn lane. In many situations, this arrangement can result in lower side street green times and therefore, a higher g/c ratio for the artery.



Figure 4-17 Standard Overlap

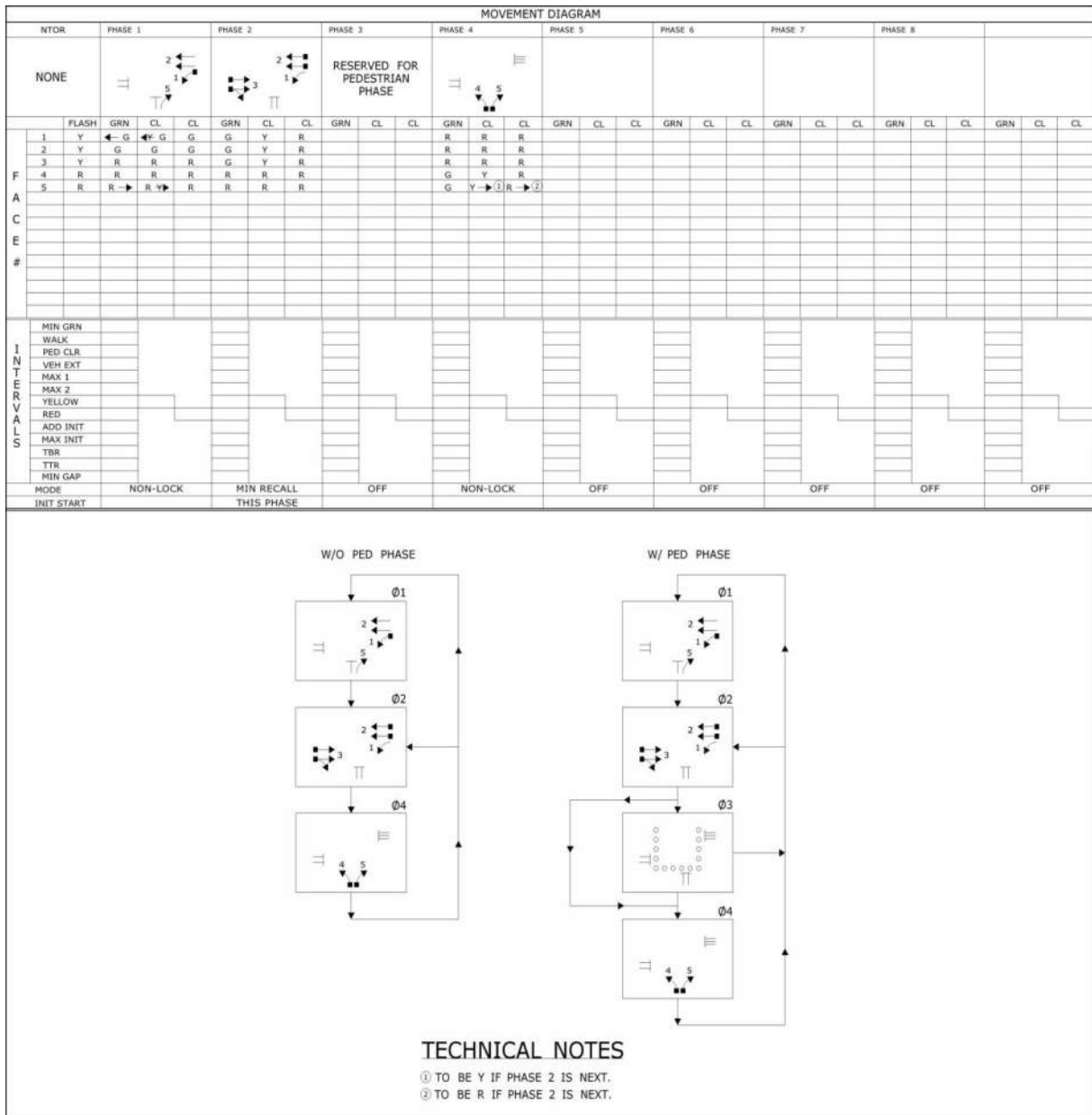

Figure 4-18 Non-Standard Overlap (Right-Turn Without Conflicting Movement)



Figure 4-19 Right-Turn With Conflicting Movement (Not an Overlap)

Pedestrian Hybrid Beacons

General

A pedestrian hybrid beacon (PHB) is a special type of traffic control device used to warn and control traffic at marked mid-block crosswalks. The following sections describe the two types of PHBs and their typical operation.

This type of traffic control device is owned and maintained by the municipality.

Refer to [Chapter 4F \(Pedestrian Hybrid Beacons\)](#) of the *MUTCD* for additional information relating to the use of PHBs.

Single Stage Crossing

A single stage crossing is the most common type of PHB. This type of crossing provides enough time for pedestrians to cross all vehicular lanes of travel from a single actuation.

See **Figure 4-20** for the typical movement diagram set-up for a single stage crossing.

Two Stage Crossing

A two stage crossing provides enough time for pedestrians to cross one direction of vehicular traffic into a pedestrian refuge area. The pedestrian is then required to press a pushbutton, in the refuge area, in order to cross the opposite direction of vehicular traffic. This type of crossing is only acceptable when a sufficient raised median island is available for pedestrian refuge and should only be considered in locations where the required pedestrian crossing times for a single stage crossing would significantly impact traffic operations.

Accessible Pedestrian Signal (APS) speech messages shall be used at all two stage crossings.

See **Figure 4-21** for the typical movement diagram set-up and phasing diagram for two stage crossings. Please note, two stage crossings use a single controller; however, each crossing operates independently from the other.

Operation

The following notes should be shown on the signal plan.

- a. Hybrid beacon faces shall be dark (not illuminated) until activated by a pushbutton.
- b. Upon actuation by a pushbutton, the hybrid beacon faces shall display a flashing yellow indication for 5 seconds.
- c. A steady yellow indication shall follow the flashing yellow indication.
- d. Steady red indications (both indications on all hybrid beacon faces) for 2 seconds (ped. delay) shall follow the steady yellow indication.
- e. Steady red indications (both indications on all hybrid beacon faces) to remain on during the walk interval.

- f. Alternating flashing red indications on each hybrid beacon face shall follow the steady red indications during the pedestrian clearance intervals.
- g. Upon completion of the pedestrian phase (Phase X), all hybrid beacon faces shall revert to dark condition (not illuminated).
- h. The pedestrian signal heads shall display a walking person indication when the hybrid beacon faces are displaying a steady red indication during the walk interval.
- i. The pedestrian signal heads shall display the countdown simultaneously with the flashing upraised hand indication when the hybrid beacon faces are displaying alternating flashing red indications during Phase X PED CLR.
- j. Upon termination of the Phase X PED CLR interval, the pedestrian signal heads shall revert to a steady upraised hand indication.

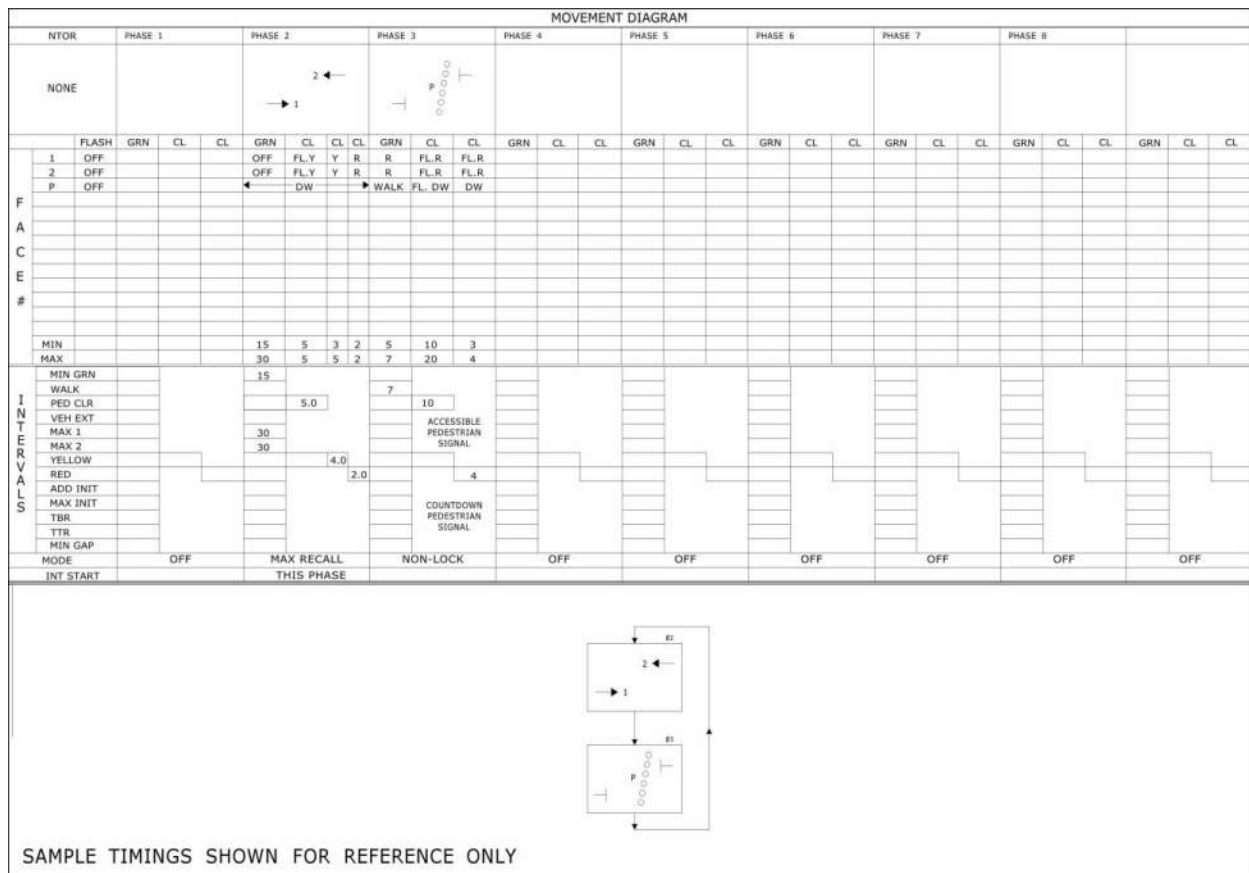

Figure 4-20 Single Stage PHB Crossing

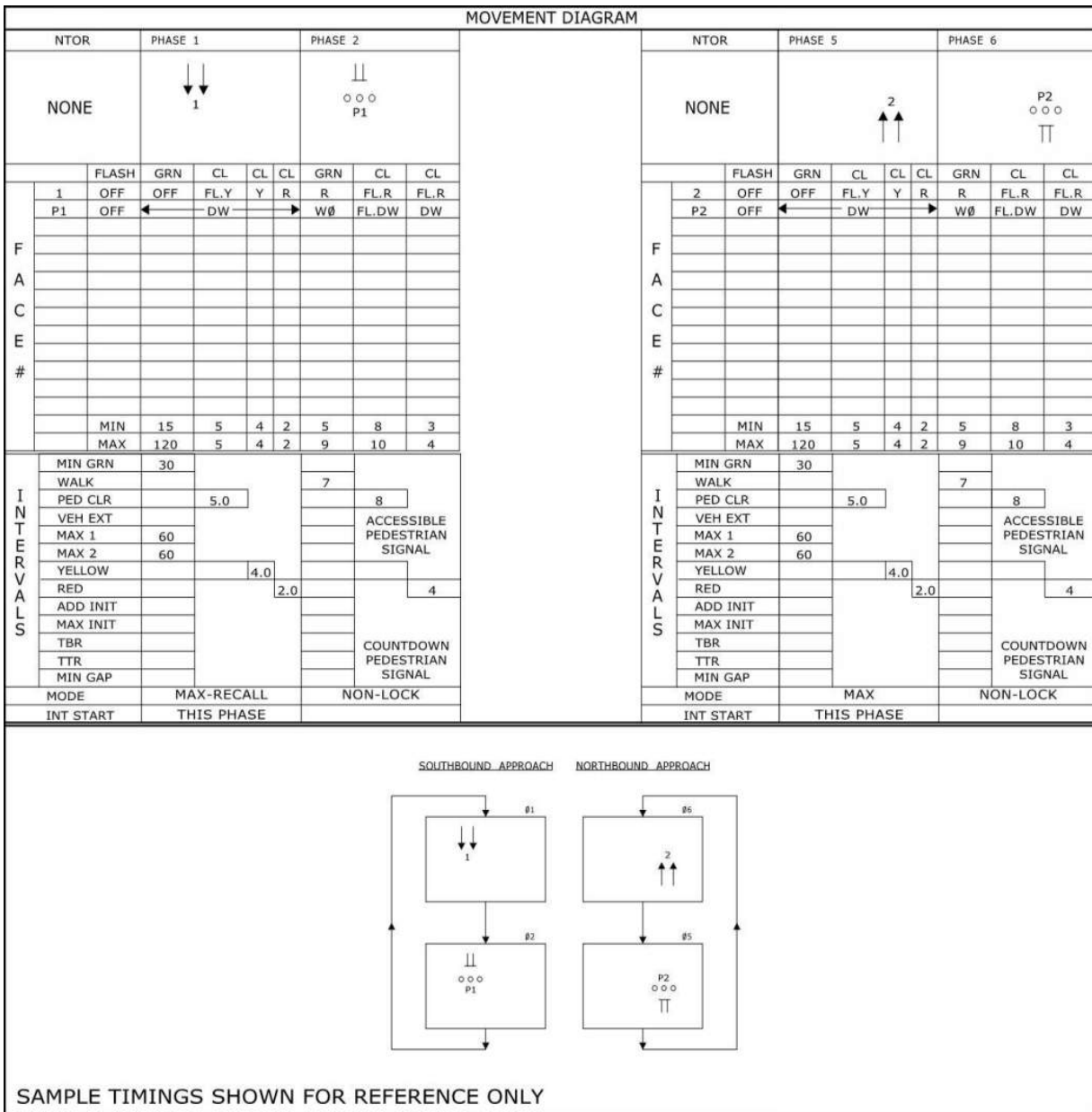

Figure 4-21 Two Stage PHB Crossing

5 CAPACITY ANALYSIS

Lost Time

Once lane arrangements and proposed phasing have been decided upon, detailed operational capacity analysis may be performed to determine timings and cycle length. Lost time must also be considered. **Lost time** per phase is the start up time (usually 2-3 sec) plus the clearance lost time, which is a portion of the yellow interval (usually 1-2 sec) and the all-red interval. When evaluating designs, a short cycle length should be used.

Cycle Length - Webster's Equation

Cycle length selection includes a determination of the cycle length that will minimize delay. One method of evaluating optimum fixed time cycle length to minimize delay is by the use of **Webster's Equation**, which is as follows:

$$C_o = \frac{1.5K + 5}{1 - Y_i}$$

where:

C_o = the optimum cycle length

K = the sum of the lost time for all phases ($k_1 + k_2 + \dots$)

$Y_i = \frac{\text{critical lane volume (i}^{\text{th}} \text{ phase, vph)}}{\text{saturation flow, vph}}$

Delay is not significantly increased by cycle length variations in the range of $.75C_o$ to $1.5C_o$.

6 SIGNAL TIMING

Maximum Green

Traffic demand at the intersection is critical in determining the number of timing plans needed and the actual timings of the phases. If the peak hour flows are significantly greater than off peak and weekend volumes, more than one timing plan should be considered and the **maximum green** times should be based on the volume splits.

The maximum green interval limits the time a phase can hold the green. When the signal is properly timed with appropriately short vehicle extensions, the maximum green interval will not consistently time out unless the intersection is significantly over capacity. The maximum green interval is typically determined based on a detailed capacity analysis of the intersection. With actuated operation, a maximum green interval of 1.25 to 1.5 times the maximum green time calculated by capacity analysis is generally desirable. This will allow the signal to better react to variations in traffic demand thereby maximizing the efficiency of signal operation. A maximum green interval that is set too low can significantly reduce the benefit of actuated operation. It should be noted that when a signal is running coordinated in a signal system, other considerations (cycle length) may take precedence in determining maximum green times.

Minimum Green

For actuated phases, **minimum green** intervals should be enough to allow vehicles stopped between the detection point and the stop bar to get started and move into the intersection. Large presence detection or other circumstances may allow shorter settings and thus more efficient operation and increased capacity. Typical minimum green times to be used for various phases are as follows: arterial phase - 15", left-turn phase - 5" and side street phases – 5" to 9". The timing for an advance green interval (actuated or non-actuated) should not be less than 5 seconds.

Vehicle Extension

The passage time or **vehicle extension** is the time required for a vehicle to travel from the detector to the stop bar or to the adjacent detector where multiple detection exists. The vehicle extension is also the time required to accommodate the gaps between vehicles. For maximum efficiency the vehicle extension should be set as short as practical to retain the green only as long as a real and consistent demand is present, but should not service vehicles straying behind. However, where detectors are located at some distance from the stop bar, the vehicle extension must be long enough to permit the vehicle to travel from the detector to the intersection without gapping out (See Chapter 7 – Vehicle and Bicycle Detection).

Gap Reduction

Volume density features, such as gap reduction and variable initial may be utilized to provide a more efficient signal operation. **Gap reduction** can be used on any actuated approach to an intersection. If a short minimum time is used on a side street, a large vehicle extension time that is reduced over the duration of the phase can provide a snappy operation. This feature reduces the possibility of the phase gapping out when slow moving vehicles cross the detection area at the beginning of the phase. The controller settings that govern gap reduction are vehicle extension; time before reduction (TBR); time to reduce (TTR) and minimum gap (MIN GAP). The gap reduction feature occurs during the green interval of the phase.

Variable Initial

In areas where speeds are great and it is necessary to have detection a distance from the stop bar, the provision of an additional detector and/or use of the variable initial feature can reduce potentially long vehicle extension times and high minimum green settings. **Variable initial** allows the minimum green period to be increased depending upon the number of vehicle actuations stored in the related phase while its signal is displaying yellow or red. The minimum green time is increased only after the added initial time amounts to more than the minimum green time and is limited by the maximum initial time setting. In cases where the calculated maximum initial is not much higher than the minimum green, the use of a minimum green equal to the calculated maximum initial value in lieu of the variable initial feature may be acceptable.

The variable initial feature is generally associated with an actuated arterial phase. The following is an example showing how the values for the added initial (ADD INIT) and maximum initial (MAX INIT) settings are typically calculated. The added initial is expressed as seconds per actuation. If only the variable initial feature of volume density functions is used, the minimum gap should be programmed to equal the vehicle extension.

Example: Determine the added initial and maximum initial values for an arterial phase of a signal with operating speeds (85th percentile) of 55 mph. Posted speed limit is 45 mph. The detection setback is 405 feet for the leading detector with an additional detector placed 2.5 seconds from the leading detector based on the posted speed limit. The additional detector is located 2.5 seconds x 45 mph (1.47) = 165 feet from the leading detector (240 feet from the stop bar).

- Determine the number of vehicles (N) which could store between the stop bar and the detector closest to the stop bar assuming an average length per vehicle of 25 feet. $N = 240 \div 25 = 9.6$ vehicles (use 10 vehicles).
- Determine the maximum initial setting (MAX INIT) which is the time needed to process the queue of vehicles stored between the stop bar and detector closest to the stop bar. $MAX\ INIT = 3.7 + 2.1 (N) = 3.7 + 2.1 (10) = 24.7$ seconds. This is based on studies that found the first vehicle had a starting delay of 3.7 seconds to enter the intersection with subsequent vehicles requiring an average of 2.1 seconds each.

- Calculate the added initial setting (ADD INIT). $ADD\ INIT = (MAX\ INIT \div N) (d) \div 2 = (24.7 \div 10) (0.60) \div 2 = 0.7$ seconds per actuation. “d” is the percent of arterial traffic on the higher volume approach during off-peak hours. For example, if directional distribution is 60/40 use $d = 0.60$. Note that in this example the calculation involves a division by two to account for the two detectors per lane on each artery approach. If the design included only one detector per lane on each artery approach, the calculation would not include a division by two.

For this example, say the normal minimum green is 15 seconds, and the ADD INIT (seconds per actuation) setting is 0.7. Only after the 22nd actuation (during yellow or red) when the sum is 15.4 seconds and thus exceeds the minimum green value of 15 seconds will the minimum green be lengthened. Each additional actuation will then lengthen the minimum green by 0.7 seconds up to the maximum initial setting.

Min/Max Timing Range (Town Signals)

In addition to actual signal settings, town signal plans require a minimum and maximum timing range for approval by the State Traffic Commission. This requires three columns of timings for GRN, CL1 & CL2. The minimum and maximum timing range for the GRN interval refer to the range from the shortest allowable minimum green to the longest maximum green. The minimum and maximum timing ranges for the WALK and DON'T WALK intervals of exclusive walk phases should be shown as indicated on **Figure 16-2**.

Clearance Intervals

Phase change intervals or clearance intervals usually consist of a yellow change interval followed by an all red clearance interval. The yellow change interval is computed to provide adequate time to warn traffic of an impending change in the right-of-way assignment. An all red clearance interval is used following the yellow change interval to provide additional time before conflicting traffic movements, including pedestrians, are released. Excessively long clearances are not recommended. Drivers may become accustomed to long clearances, particularly red intervals, and increased violation of the clearance interval may occur. The following is the current engineering practice to determine clearance intervals for vehicular phases. Clearance intervals for pedestrian phases are discussed in Chapter 11 (Pedestrian/Bicyclist Considerations).

Conflict Points

A conflict point is the intersection of two vehicle paths. Critical conflict points occur at the intersection of the longest clearing distance from one approach and the shortest entering distance of an opposing approach.

Figure 6-1 shows the potential conflict points between two vehicles at four way intersections and some examples of critical conflict points for clearing vehicles at various approaches on multi-lane roadways.

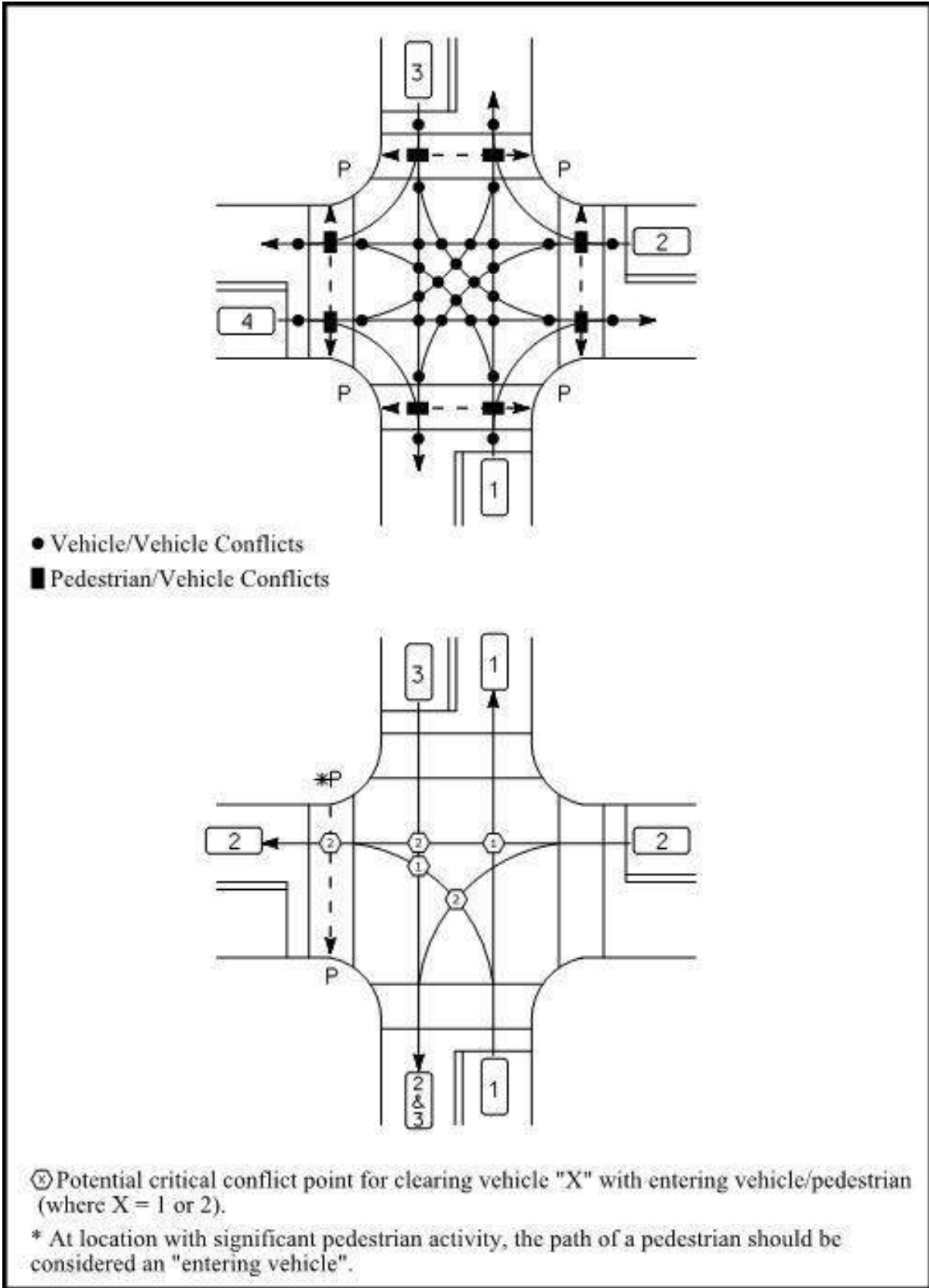

Figure 6-1 Conflict Points

Yellow Change Interval

Compute the yellow change interval for each phase using the following formula:

$$Y = t + \frac{V}{(2a + 2Ag)}$$

where:

Y = Yellow change interval in seconds

t = reaction time (use 1 second)

V = 85% percentile approach speed in ft/sec or m/sec

a = deceleration rate of a vehicle (use 10 ft/sec² or 3 m/sec²)

A = Acceleration due to gravity (32.2 ft/sec² or 9.81 m/sec²)

g = percent grade in decimal form (+ for upgrade, - for downgrade)

- Calculate the yellow change interval to the nearest 0.1 second.
- Do not use a yellow change interval of less than 3 seconds or (not normally) more than 5 seconds.
- Similar yellow change intervals for the artery should be considered in a system.
- In instances where the side street approach has a low minimum green, presence detection at the stop bar, and a low vehicle extension, it can be assumed that most approaching drivers on the side street are expecting to stop at the intersection. In that case, a yellow change interval of 3 seconds may be appropriate.
- An approach speed of 25 mph can be assumed for left-turning vehicles.

All Red Clearance Interval

Compute the all red clearance interval for each phase using the following formula:

$$R = T_c - T_e + K$$

where:

R = all red clearance interval in seconds

T_c = the clearing time, i.e. the time that the last vehicle of the clearing stream takes to cover the clearance distance D_c in feet, measured from the stop bar to the conflict point. (See **Figure 6-1** for definition of conflict point).

$T_c = D_c \div V_c$, where V_c = clearance speed (use speed limit in ft/sec or m/sec).

T_e = the entering time, i.e. the time that the first vehicle of the entering stream of the next phase takes to cover the entering distance D_e in feet or meters, measured from the stop bar to the conflict point.

$T_e = D_e \div V_e$, where V_e = entrance speed (use 15 mph converted to ft/sec or m/sec, or adjust based on field observations).

K = the time that the last vehicle of the clearing stream takes to clear the conflict point, usually 1.0 second.

- Calculate the all red clearance interval to the nearest 0.1 second.
- The all red clearance interval should be a minimum of 1.0 second unless engineering considerations indicate another value.
- Care should be taken when calculating the all red clearance intervals in coordinated traffic signal systems. Timings in these systems may be such that an entering motorist can correctly predict the onset of the green interval and thus get a "running" start through the intersection.
- For turning vehicles, the value of V_c should be based on field observations and be appropriate for existing geometry. A value of 20 mph for left-turning vehicles should be used if information on observed vehicles is not available.
- For arterial protected/permitted left-turn phasing, an all red clearance interval of 1.0 second should be used so as not to violate driver expectancy.
- For non-arterial protected/permitted left-turn phasing, the all red clearance interval should be determined after a careful review of all possible phasing which may follow the left-turn phase. In many instances, an all red interval of 1.0 second is appropriate.
- For protected-only left-turn phasing, the all red clearance interval should be calculated using the formula.

7 DETECTION

Detection

Detection is used to sense pedestrian, bicycle, or vehicular demand. The demand information is then provided to the controller.

Controller Operation

Traffic control signals can be pre-timed or actuated. Actuated controllers can be **semi-actuated** or **full-actuated**. In semi-actuated operation detection is not provided for arterial through traffic and the right-of-way is relinquished only when a call is received for an actuated phase. Full-actuated operation requires detection on all approaches and the right-of-way does not automatically go to a designated phase unless it is recalled by a function on the controller. The type of detection system used for actuated signal control depends on the operational requirements of the intersection and may be influenced by physical constraints (i.e. lack of right-of-way, poor pavement conditions, bridge structures, etc.).

On State highways, new signal installations and full signal equipment replacements shall be designed for full-actuated operation. If a signal will be in a coordinated system, a full-actuated design shall still be provided and a technical note indicating “ARTERY PHASE DETECTION AREAS TO BE NON-ACTUATING DURING COORDINATION” shall be added to the plan.

Controllers have four phase modes.

- **Non-Lock** – a waiting call is dropped by the controller as soon as the vehicle leaves the detection area. Non-lock is associated with large areas of detection at the stop bar, which can reduce delay by screening out dropped calls.
- **Lock** – a call is held by the controller until the associated phase begins, even after the vehicle has left the detection area. Lock is associated with point detection, which is incapable of screening out dropped calls.
- **Minimum Recall** – returns to the selected phase for the minimum green time for that phase, and is used primarily for the artery phase of a full-actuated signal and for the phase in which the signal is expected to rest.
- **Maximum Recall** – returns to the selected phase for the maximum green time for that phase, and is used primarily for fixed time advances and the artery phase of semi-actuated signals.

Detection Mode/Features

Detection zones have two modes.

- **Presence** – used for areas of detection to register a vehicle or bicycle’s presence in a detection zone. The call is held as long as a vehicle remains within the zone. The controller may be set for either lock or non-lock memory.

- **Pulse** – a detection zone that detects the passage of a vehicle by motion only (point detection). A call is placed when a vehicle enters the detection zone. This detection mode is associated with lock memory and is primarily used with microwave detection.

Detection also has **delay** and **extend** features available.

- **Delay** – the call is output to the controller only if a vehicle is continuously detected beyond a preset time period. This feature can only be used with presence detection mode and is typically used to screen out false calls.
- **Extend** – the call is held for a preset time after the vehicle leaves the detection zone. This allows a passing vehicle to reach a predetermined point beyond the detection zone before the call is terminated without using a higher than desired vehicle extension. Please note this feature is associated with extending a call to the controller and is not the same as a vehicle extension timing.

Detection Area Design Guidelines

For all approach types, detection areas should be centered in the lane. This reduces the possibility of vehicles traveling in adjacent lanes accidentally calling a phase. The longitudinal placement is dependent upon the approach type, as described in the following sections.

Arterial Detection Areas

Detection areas on arterials are based on operating speed of through traffic, which is considered to be the observed 85th percentile speed.

Approach speeds less than 35 mph:

A single detection area is needed which should be located 3 seconds from the stop bar based on the 85th percentile speed. The problem of the driver being faced with indecision on whether to proceed through the intersection or stop is seldom an issue with speeds less than 35 mph. The controller mode should be set to min recall and the detection mode to presence.

Approach speeds 35 mph or greater:

Detection areas are needed for high speed approaches in order to provide dilemma zone detection. To minimize vehicle extensions and provide dilemma zone detection, two detection areas should be installed. However, a single video detection area could be used to cover the entire dilemma zone eliminating the need for a vehicle extension time. Refer to the following Dilemma Zone section for design guidance.

Dilemma Zone

Dilemma zone is defined as the range of distances from the stop bar where 10% to 90% of vehicles will stop at the onset of yellow. When the yellow change interval begins a driver is faced with a decision to stop or proceed through the intersection, known as the dilemma zone. The standard method for avoiding trapped vehicles is to place a detection area at the 90% point and allow vehicles to extend the interval sufficiently to ensure that they pass the lower 10% limit prior to the onset of yellow.

A common practice is to locate the leading detection area 5 seconds from the stop bar based on the 85th percentile speed and a trailing detection area located 2.5 seconds from the leading detector based on the posted speed limit. Vehicle extensions should be sufficient for a vehicle traveling at the posted speed limit to travel from the arterial detection areas to beyond the lower limit dilemma zone distance from the stop bar. This method of design was developed to ensure that vehicles traveling at the posted speed limit will not be trapped within the dilemma zone. The variable initial feature could be considered to reduce minimum green values if desired. The controller mode should be set to min recall and the detection mode to presence.

The following table is from the Traffic Control Systems Handbook and lists those distances at which 10% and 90% of approaching vehicles are expected to stop for various speeds.

Speed (MPH)	Distance (Feet)	
	Probability of Stopping	
	10%	90%
35	102	254
40	122	284
45	152	327
50	172	353
55	234	386

A trap check should be performed to ensure vehicles traveling the speed limit will not be within the dilemma zone upon termination of artery green.

- Determined by subtracting the distance a vehicle traveling the speed limit will cover during the extension time (typically 2.5 seconds) from the setback distance of the trailing detection area. See **Figure 7-1**.
- The difference should be less than the lower dilemma zone limit (see table) at the speed limit. Generally, slower vehicles will not be trapped if the posted speed limit and 85th percentile speed are within 15 mph of each other.

When a phase terminates at maximum time, dilemma zone protection will not be provided. Therefore, maximum green settings should be based on a careful consideration of capacity analysis, which balances the efficiency of signal operation with the safety benefits of dilemma zone protection.

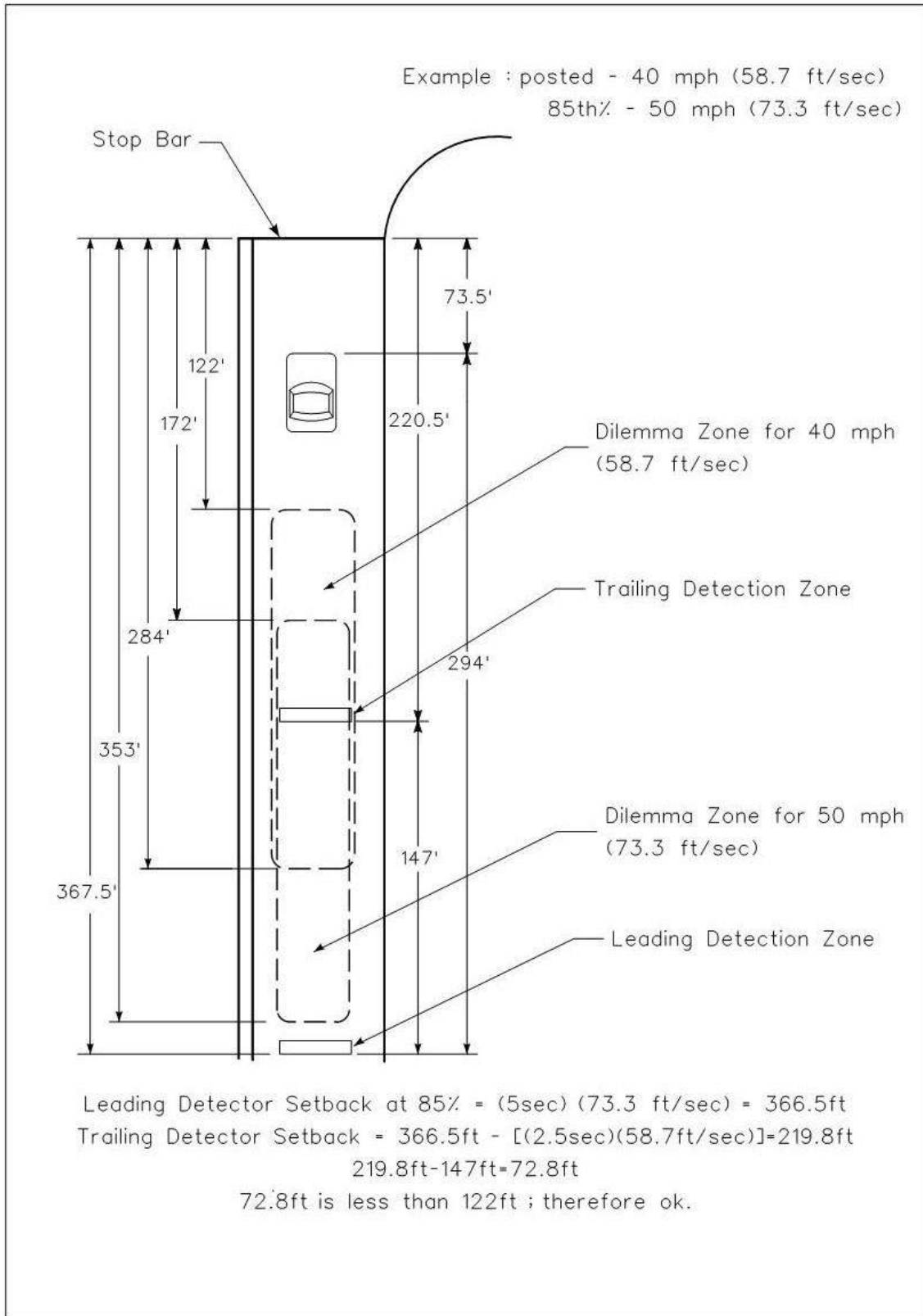

Figure 7-1 Dilemma Zone Trap Check (Two Detectors)

Left-Turn Lane Detection

Where exclusive left-turn lanes exist, detection should be provided to cover the desired detection area adjacent to the stop bar. The detection area should not end less than 25 feet from the stop bar. See **Figure 7-2** for standard placement of detection zones. The controller phase mode should be set to non-lock and the detection mode to presence.

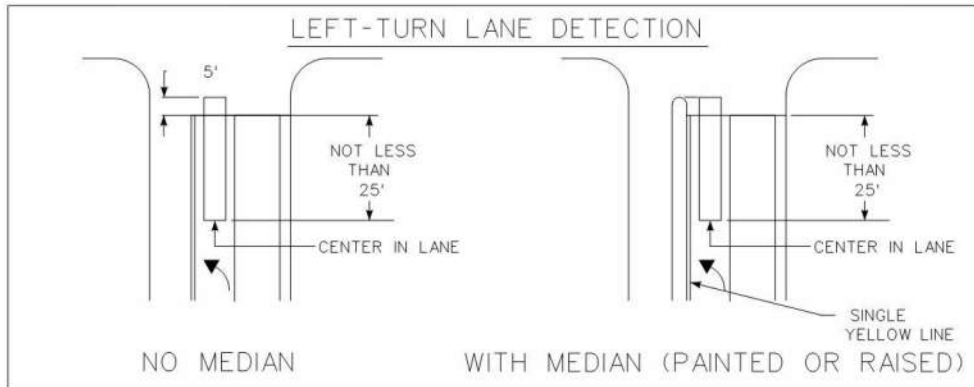

Figure 7-2 Placement of Left-Turn Lane Detection

Where no left-turn lane exists and a fixed advance or lag green phase is designed, consider installing a detection area within the intersection such that the wheel path of the left-turning vehicle will actuate and extend the left-turn phase. For a fixed advance the technical note "Detector D1 to only extend phase 1" should be added to the plan. Additionally, the controller phase mode should be set to **MIN RECALL**. An example of this can be seen in **Figure 7-3**.

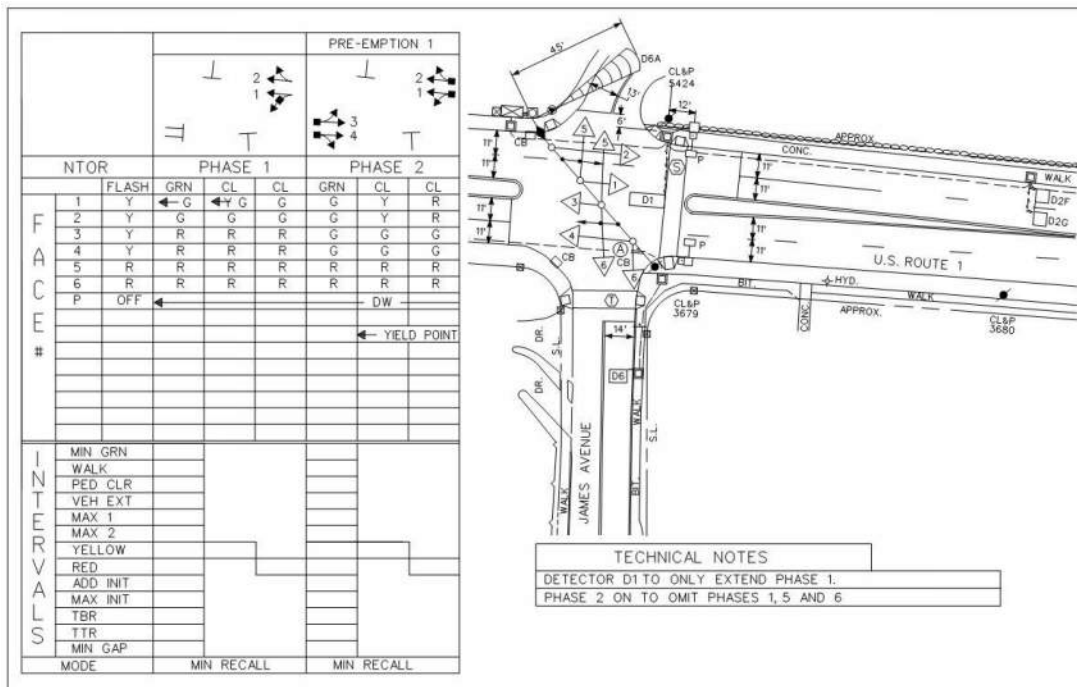

Figure 7-3 Left-Turn Lane Detection

Side Street Detection

Side street detection should be provided to cover an appropriate detection area adjacent to the stop bar. For through lanes, single lane approaches, and right-turn lanes the recommended detection zone should begin no closer than 10 feet from the adjacent road's curb line extension and end not less than 25 feet from the stop bar. The controller phase mode should be **NON-LOCK** and the detector mode **PRESENCE**. See **Figure 7-4** for detection area placement.

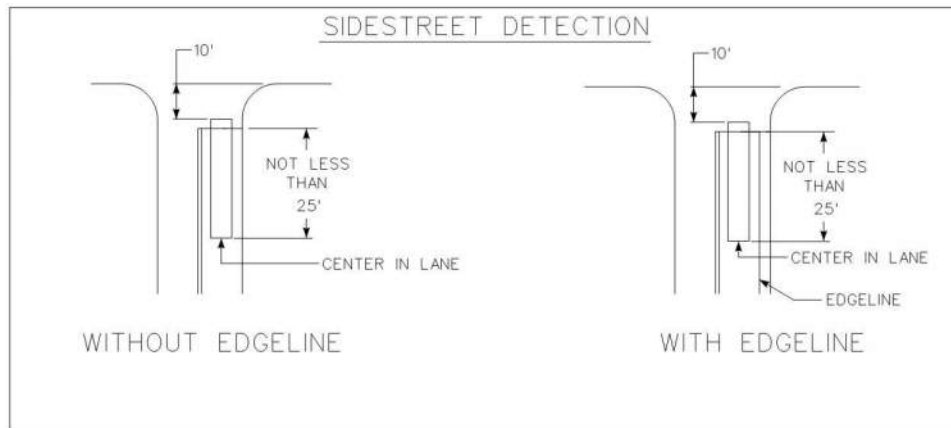

Figure 7-4 Placement of Side Street Detection

System Detection

System detection should be considered for signal designs/revisions which are part of closed loop systems. Contact the Department for guidance on the necessity, type, and placement of system detection.

Miscellaneous

1. Detection zones should not be located within crosswalks.
2. The following items pertain to how detection zones are shown:
 - Detection zones should usually be shown as square, rectangular, or other geometric shape on signal plans.
 - Loop and wireless detectors have a typical longitudinal dimension (length) equal to 6 feet whereas the length of video detection zones may vary.
 - The lateral dimension (width) should be determined based on lane width.
 - A detection zone should be sized to be centered in the lane and 3 feet off each adjacent centerline, lane line, or edge line/curb line. For lanes less than 12 feet wide, the detection zone(s) should be 6 feet wide and centered in the lane.
 - The size of detection zones, as shown in the DETECTORS block of signal plans, should be denoted as *Width X Length*.
 - In general, detection areas should not extend across more than one lane.

3. Detection zone numbers should correspond to the appropriate signal phase where possible. On approaches with two detection zones for dilemma zone protection, each detector should be identified by a unique number (for example: D2, D2A, D2B, and D2C).
4. On approaches with wide throat areas and/or where right-turn on red is prohibited, provide a detection zone that ensures right-turning vehicles are adequately detected. This may include a trapezoidal or other geometric shape detection zone where video detection is utilized. Critical dimensions should be shown on the plan and the size of detection zones should be denoted as "SEE PLAN" in the DETECTORS block.
5. In a loop detector design, the rear loop of a multi-loop approach may be used as a system detector to obtain volume counts in a closed loop system; however, the length must be 6 feet to obtain accurate counts.
6. Consider using gap reduction at isolated intersections with relatively equal volumes on all approaches and where capacity is of concern.

Vehicular Detection Systems

There are many types of detection systems available. Below is a brief description, in order of preference, of the most common types of systems used:

- **Video Detection** consists of a video image detector and a computer system that analyzes video images. Detection zones are placed on the video image displayed on a monitor.
- **Wireless Detection** uses battery-powered magnetic sensors that lie beneath the surface of the road and transmit information to an associated receiver.
- **Loop Detection** consists of a coil of wire beneath the surface of the road and an amplifier located in the controller cabinet.
- **Microwave (Radar) Detection** uses a radio transmitter/receiver to transmit a high frequency, low power signal to the desired detection zone. When a vehicle enters the detection zone this signal is reflected back to the detector.

Video Detection Guidelines

Video detection is a non-intrusive detection technology. The video image detection system consists of a detector and an image processor. The detector is fixed mounted, usually on a far-side mast arm assembly or a steel pole. It is located so as to feed an image of the approach to the processor. Detection zones are then superimposed on the image. The processor senses contrast changes within the zone and then outputs a call to the controller unit. The processor may be programmed to provide outputs which emulate a loop detection system (pulse, presence, delay, and extend). If desired, the processor will accumulate data such as volume, occupancy, speed, and vehicle classification.

Three types of Video Detection systems are commonly available:

- **360-degree Video Detection** uses a high-resolution color optical camera equipped with a fish-eye lens which allows a single camera to see all approaches of an intersection. A single 360-degree camera can provide detection for an entire intersection under certain circumstances, though typically advance cameras are still required for arterial detection. 360-degree cameras have the same drawbacks as optical cameras. A special video detection processor is also required, but this processor will work with up to four advance cameras or thermal sensors along with one 360-degree camera.
- **Thermal Video Detection** uses a thermal imaging sensor to create a monochromatic heat-based image for processing. Thermal sensors do not require illumination to detect accurately and still work properly during adverse weather and in direct sunlight. Thermal sensors typically generate a lower resolution image compared to optical cameras. Most video detection processors can use both optical cameras and thermal imaging sensors.
- **Standard Video Detection** uses an optical camera to create a video image for processing. Optical cameras can be monochrome or color. Optical cameras may have difficulties in dimly lit areas, under certain weather conditions, and when sun glare is present. Headlight bloom at night may also cause errant actuations.

Video Detector Placement

The following considerations should be taken when designing video detector placement:

- The ideal detector mounting location is in front of the approaching vehicle and as high as possible with an unobstructed line of sight to the area of detection. The view of a detector mounted low or at an angle may be obstructed by an adjacent lane vehicle which is known as cross-lane occlusion.
 - If the approach must be viewed at an angle, the detector should be positioned to minimize occlusion of left turning vehicles.
- Recommended mounting height is 20 to 35 feet. The suggested rule is a 1 to 10 ratio of mounting height to distance to the detection zone. A low mounting height may cause occlusion of approaching vehicles.
- Detectors should be a range of 300-400 feet from the furthest detection zone.
- Optical cameras should have a clear view of the headlights of approaching vehicles.
 - External illumination may also be required.
- Thermal detectors can be used on east-west approaches to negate the glare from a rising or setting sun.
 - Poorly illuminated intersections benefit from Thermal Detection

- 360-degree cameras can detect all approaches of an intersection. For most intersections one camera can be used, but for large intersections, two 360-degree cameras may be needed.
 - For single camera installations, the camera should be mounted at least 30 feet above the roadway, no more than 75 feet from the center of the intersection, and no more than 150 feet from the front of the furthest stop bar. The camera must be mounted in front of all stop bars.
 - For two camera installations, the cameras should be installed on opposite corners.
 - Each camera can track and detect vehicles up to 200 feet away, radially.
 - If mast-arm mounting is used, the camera should be no more than 50 feet from the center of the intersection, and the maximum detection distance will be reduced if the mounting height is less than 30 feet.
 - 360-degree cameras may be co-mounted on the same mounting bracket with either an optical or a thermal advance detector.
- The grade of the approach may affect the detection zone and detector placement.
- The final detector mounting location should be as recommended by the specific manufacturer's representative. Prior to construction, a site survey shall be performed and documented by the contractor and the representative to identify and resolve any potential issues with the video image detection design.

Advantages of Video Detection

- Detection zones may be easily adjusted or relocated to fine tune an intersection or to accommodate temporary signalization
- Installation and maintenance does not depend on good pavement conditions, an easement on private property, or lane closures

Disadvantages of Video Detection

- Video image detector location is crucial for effective operation
- Accuracy degradation under certain conditions such as: congested conditions; low visibility; low vehicle to pavement contrast
- Not as effective for ramp (force off) preemption
- Subject to vehicle occlusion
- Adverse weather conditions may reduce effectiveness

Wireless Detection Guidelines

Wireless Detection uses a directional magnetometer sensor installed in a 4 inch diameter hole drilled into the roadway. The sensors send a detection signal to a receiver connected to the controller cabinet. The receiver is connected to a processor in the cabinet which provides detection information to the controller.

Wireless Detector Placement

- Installed 4.25 inches below the surface of the pavement or based on the manufacturer's recommendation.
- Can be installed in relatively poor pavement in a small patched area.
- Installation takes about 15 minutes per sensor and the epoxy cover dries in 5 minutes, reducing disruption time to traffic.
- No trenching is required for artery detection though a tall pedestal may be required for a transceiver.
- Sensors can transmit a signal approximately 150 feet to a transceiver which relays the signal to the receiver up to 1,000 feet away or 2,000 feet away with use of a repeater.
- The detection area of a sensor is approximately a 6 foot diameter zone where detection is most effective 4 feet in front of and 2 feet behind the sensor.

Advantages of Wireless Detection

- Battery powered, low power consumption, and can be used in areas with deteriorated pavement
- Simplified maintenance

Disadvantages of Wireless Detection

- Single lane closure required during installation
- Line of sight required between transceivers and receiver
- Sensors and transceivers battery life

Loop Detection Guidelines

Loops are typically wound wire installed in a pavement cut. This coil of wire creates a magnetic field which is disrupted by the passage of a vehicle. This disruption is then detected by the amplifier in the controller cabinet. Cutting the pavement this way may hasten the deterioration of the pavement. Alternately, loops can be pre-formed.

Loop Detector Placement

- Loop detection should only be considered if other types of detection are not feasible.
- Loop detectors cannot be installed in deteriorated pavement.
- Loop detection installation requires lane closures and the installation of conduit and handholes adjacent to detection area.
- Stop bar loop detection typically uses three or more loops spaced 8 feet apart and wired in series. Typically one amplifier per lane of detection is used for stop bar detection.
- Artery loop detection typically uses one loop per detection zone. Each artery detection zone will have its own amplifier.
- In Closed Loop Systems, a rear loop at the stop bar used as a System Detector will require a separate amplifier.
- Pre-formed loops have the designed number of turns of wire encased in protective tubing and are installed after full depth reconstruction and prior to paving the roadway.
- Pre-formed loops may also be attached to re-bar in a concrete bridge deck.

Advantages of Loop Detection

- Very accurate detection

Disadvantages of Loop Detection

- Loops may not effectively detect some motorcycles
- May require easement onto private property
- Service life is affected by pavement conditions
- Lane closures are required during installation and may be required for repair

Microwave Detection Guidelines

Microwave detection is a non-intrusive method; however, because of the restrictions on placement and lack of presence detection, it is usually used on an approach where other detection types are not feasible. The area of detection is usually shown as a shaded 30 degree cone aimed at the approach rather than rectangular symbols. Since microwave detectors cannot provide true presence detection, the phase must be on lock.

Characteristics of Microwave Detection

- The microwave detector is directional and requires movement. It may be set for either approaching or departing vehicles. If set to detect approaching vehicles it will exclude departing vehicles.
- The cone of detection is approximately 30 degrees.
- The range is 25 to 150 feet.
- The minimum detection speed is normally 5 mph.
- The call will be held as long as the vehicle is moving within the detection zone.
- True presence detection mode, delay, and extend features are not available.

Placement of Microwave Detectors

- Fixed-mount to a support structure (span pole or mast arm assembly) or a tall pedestal.
- Unobstructed line-of-sight to the area of detection.
- Most desirable location is in front and above the approaching vehicle.
- Recommended mounting height is between 15 and 24 feet.
- Should not be used for left-turn lanes with concurrent through movement.

Advantages of Microwave Detection

- Lane closures during installation are not necessary
- Can be used on any surface

Disadvantages of Microwave Detection

- Complex to maintain
- Cannot be used in presence mode

Bicycle Detection Guidelines

Ideal bicycle detection design includes thermal video detectors, standard video cameras, or inductive loops as detection devices and appropriately located detection areas. In addition, bicycle boxes should only be used where bicycle lanes are present.

Bicycle Detection Devices

Standard and thermal video detectors are the preferred bicyclist detection devices. The cameras detect either the physical presence or the heat signature of a bicyclist as they cross a virtual detection area. Detectors do not require specific design changes to ensure reliable bicycle detection, unlike inductive loops.

Bicycles require a unique inductive loop design. A typical loop is not sufficiently sensitive to reliably detect bicycles, especially those with low amounts of metal in their construction, such as carbon fiber framed bicycles. A bicycle must often stop directly on the loop wire, or oftentimes wait for a motor vehicle to call the phase. To combat these difficulties, a quadrupole (or “Figure 8”) traffic loop should be installed. The “Figure 8” provides increased sensitivity in the center of the loop, which increases overall reliability. Refer to **Figure 7-5** for installation details.

Department practice prioritizes video cameras and inductive loops as the preferred bicycle detection devices for new signal equipment installations, in that order. Additionally, pavement markings designating bicycle detection areas are often used in conjunction with these devices.

Bicycle Detection Methods

Typically, motor vehicle detection areas are located in a manner that is also conducive to bicyclists. Side-street detection areas should be located at the stop bar, which is also typical for motor vehicles.

Bicycle boxes are a detection method that places bicyclists in front of motor vehicles at a red signal, instead of within the vehicle queue. The bicycle box is placed in front of the stop bar, removing the bicyclist from the vehicle queue, and is especially helpful for left-turn movements.

Refer to **Figure 7-6** for additional details. **The use of bicycle boxes on any roadway requires the municipality to obtain interim approval from FHWA.**

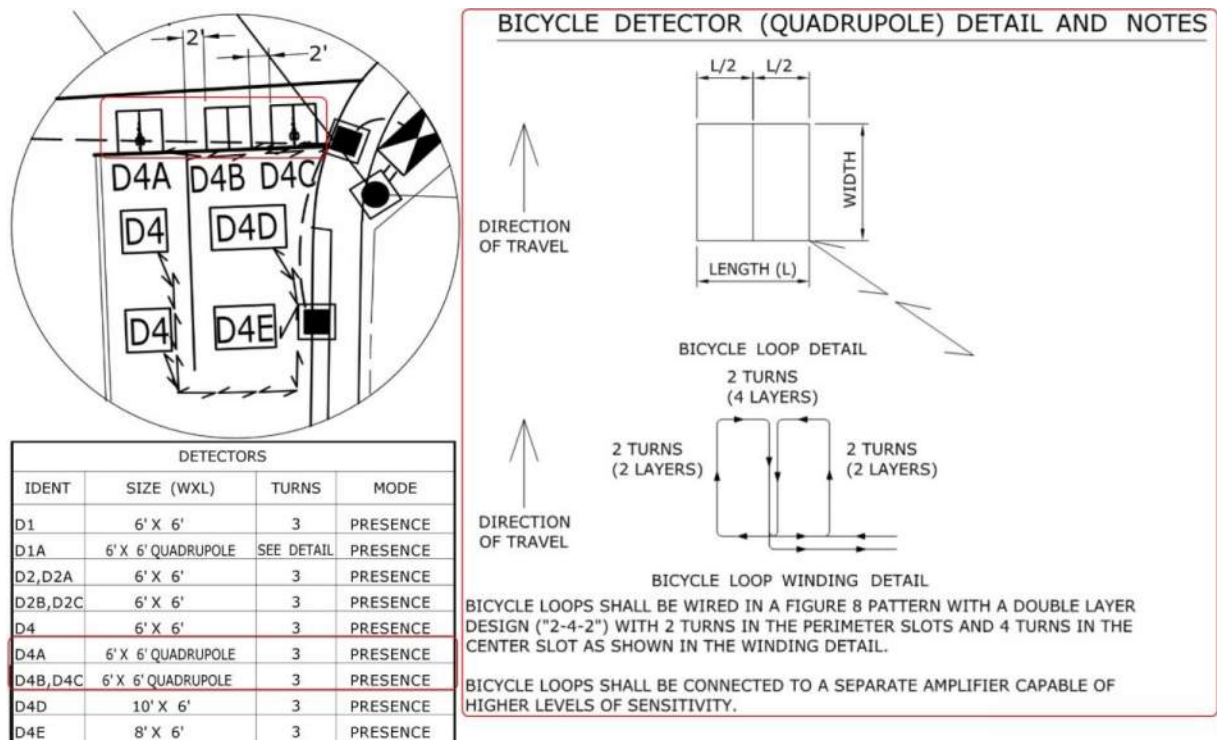

Figure 7-5 Figure 8 Pattern Bicycle Loop

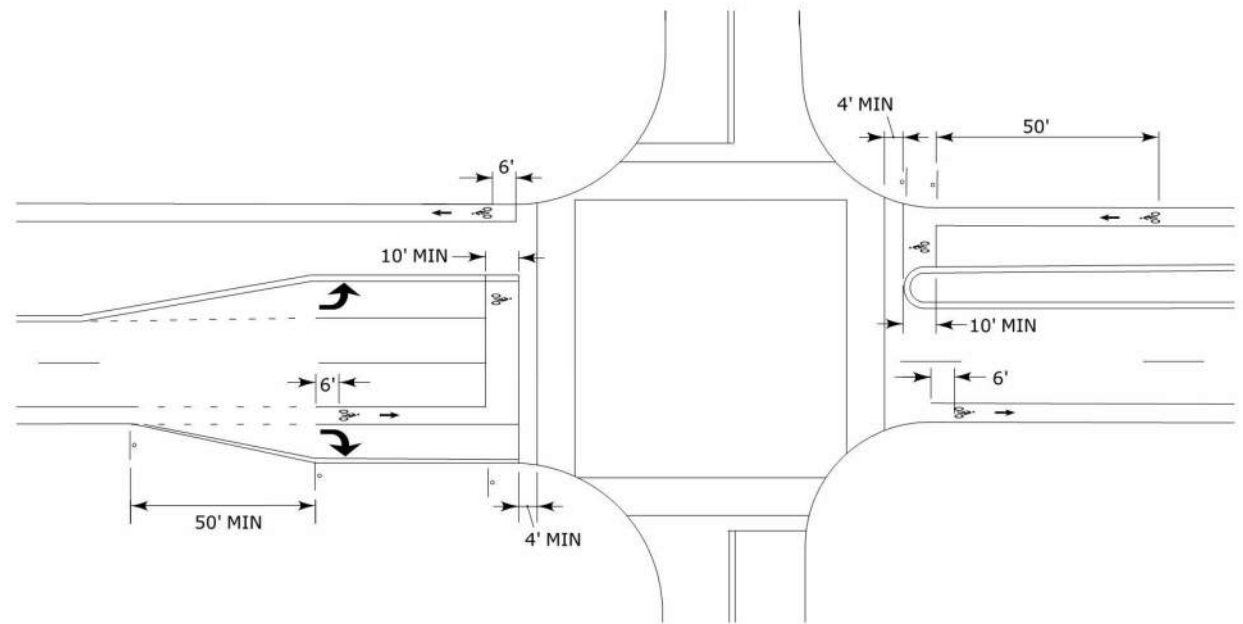

Figure 7-6 Bicycle Box

8 FLASHING OPERATION AND MAINTENANCE LEVEL

Flashing Operation

New traffic signal designs should not use **programmed flashing operation**. New designs should indicate “FLASH” as “NONE” in the Program Block. During a malfunction flashing operation, the artery typically flashes yellow while the side streets flash red. Three section protected only left turn signal faces shall flash the red indication.

When exiting flashing operation and beginning normal operation, the controller should start in the arterial phase which is usually Phase 2 or Phases 2/6.

Existing traffic signals may have programmed flashing operation during those hours when volume warrants are not satisfied if all of the following conditions are met:

- The artery displays a flashing yellow during flash operation.
- There are no sight line restrictions from the side streets.
- No special feature (such as railroad pre-emption, drawbridge, etc.) of the signal requires continuous operation.

Potential situations for an All Red flashing operation may include:

- Railroad pre-empted signals or drawbridges
- Major intersections with approximately equal volumes on all approaches
- Unusual geometry where it may be difficult to determine which approaches would normally flash yellow during a malfunction
- Intersection sight distance restrictions

Maintenance Level

Traffic signal **maintenance level** is based on safety and operational considerations. Justification for an elevated level, alone or in combination, may consist of:

- Restricted sightlines from side streets
- Unusual geometry/phasing
- High traffic volumes during hours outside normal maintenance periods

Any recommendation for a change to the maintenance level of an existing signal will be reviewed by the Division of Traffic Engineering and the Signal Lab.

Level 1 **24 Hours**, daily. Example: Traffic signal that has railroad pre-emption.

Level 2 **Priority**, 4 AM to 8 PM, daily. Example: Traffic signal on a commuter route.

Level 3 **Priority**, 8 AM to 8 PM, daily. Example: Traffic signal at a shopping center.

Level 4 **Seasonal**, same as level 2 from Memorial Day to Labor Day. Example: Signals along primary recreational routes.

Level 5 **Normal**, 8 AM to 4 PM, Monday through Friday.

9 PRE-EMPTION

Pre-emption is a feature used to modify the operation of a traffic control signal to grant right of way to emergency vehicles, trains or a specific traffic movement to meet a special need. This can be accomplished by modifying timing, sequence or display. When a pre-emption sequence is provided, special timings (i.e. clearance intervals, alternative minimum green time, etc.) will be required. Pedestrian walk and clearance intervals may be shortened or eliminated in order to provide a quick transition to the railroad track clearance display. In addition, the designer must specify how the signal returns to normal operation after the pre-emption sequence is completed.

Federal/State funds allocated for a State owned traffic signal upgrade will not be used to upgrade an associated town owned EVPS. All costs for the upgrade of existing pre-emption equipment are the responsibility of the town. Federal/State funds may be used to relocate the existing pre-emption equipment to the upgraded traffic signal if the town desires. A specification has been developed by the Department for this work and is available to the designer.

Emergency Vehicle Pre-Emption

In accordance with the Departments Policy No. E & H.O.-16, the State permits a municipality to pre-empt State maintained traffic signals. Funding for the initial installation of an EVPS is described in this policy and also in the section on Signal Ownership and Maintenance. All equipment necessary for pre-emption but not essential for normal intersection control is owned and maintained by the municipality. This includes, but is not limited to, the optical detector, RF receiver, phase selector and auxiliary equipment cabinet. This cabinet is required to allow accessibility by the Town without entering the State owned controller cabinet. There are a maximum number of six separate pre-emption movements available.

The emergency vehicle pre-emption system (EVPS) causes the traffic signal controller to advance to, and/or hold a desired traffic signal pre-emption phase. Some methods used to activate emergency vehicle pre-emption are coded light transmissions, hardwire, radio signals and siren. They require a controller that has the internal pre-emption capability and are described below.

System Types

Coded Light (Optical)

This system employs optical communication to identify the presence of a designated emergency vehicle (such as fire apparatus). Several components comprise the system. There is an optical emitter which is a high-intensity electronic (strobe) light mounted on the emergency vehicle. An optical detector is also provided. It is a directional electronic device which "sees" the coded signal from the emitter on the emergency vehicle from a distance up to 1800 feet (550 m). The third component is a phase selector. This electronic unit is interfaced with the traffic signal controller. The unit receives the pre-emption call from the detector and sends the command to the controller, which engages pre-emption.

Hardwire

This system employs a physical connection to identify the presence of designated emergency vehicle(s). The system requires a cable from the controller to an activation switch. The switch is located at the source of a pre-emption call (such as a fire station). Railroad Pre-Emption also uses this method with the exception that it uses an energized electrical loop with power sent and returned through a set of relays, and is subsequently discussed in this manual.

Radio

This system employs a radio frequency (RF) signal to initiate the pre-emption sequence. The pre-emption command may be transmitted over a narrowband system or over a wideband system which is called spread spectrum. In the narrowband system the signal is sent directly from the fire station to a receiver at the controller cabinet through the fire departments existing RF system. A direct line-of-sight is not needed with a narrowband system. A Town-owned receiver at the controller is required. The Spread Spectrum technology may also be used. Although the capabilities of an RF communication system are far more than necessary for pre-emption activation, it may be economical where it would be costly or impractical to install hardwire (such as over a movable bridge or a RR right-of-way). A direct line-of-sight is preferable with a spread spectrum system, however may not be necessary. A transmitter and receiver(s) are required to complete the system.

Siren

This system employs the emergency vehicle's siren to identify the presence of an emergency vehicle. Directional microphones detect when and from which direction an emergency vehicle approaches an intersection. The system is adjustable for vehicle range and also for audible signature, such as yelp, wail, and high-low. This system detects all federally-approved Class A sirens eliminating the need for a transmitter on each vehicle.

Emergency Vehicle Pre-emption Design Guidelines

1. The design will be for primary response routes only. If not already on file, a map of the town indicating the location of all fire houses, all signalized intersections, and the primary response routes must be submitted to the Division of Traffic Engineering by the town. This map will be stored in Unit 1406 (Electrical).
2. The Town should be contacted regarding the inclusion, funding, and design of the EVPS for new signals or major revisions. Emitters are provided for major fire apparatus only.

3. Pre-emption confirmation lights (CL) are generally not allowed on state owned traffic signals. A special condition may warrant a CL such as a fire route from a one-way street that does not have signal indications. Confirmation lights are typically not included in State owned traffic signals because in the event of an equipment malfunction the confirmation light could mislead the emergency vehicle operator. A confirmation light may be included in the EVPS of a Town owned traffic signal.
4. The signal phase(s) associated with the pre-emption movement will be labeled "PRE-EMPT" along with a number, which indicates the priority level. For example, a #1 is the highest priority followed by 2, 3 etc.
5. If the desired pre-emption phase is exactly the same as a normal phase in the sequence, that phase should be designated the hold phase.
6. If the desired pre-emption phase is not exactly the same as a normal phase, a separate phase must be added to the movement diagram and designated the hold phase (e.g. phase 8). The phase will be serviced only during the pre-emption movement. The mode should be On/Omit. This prevents the phase from being serviced after initialization or during manual operation. The hold green (minimum green), yellow and red timings are shown in the phase as well as in the pre-emption settings block.
7. When a sequence that contains a non-standard overlap (e.g. right-turn arrow) is pre-empted, skipped phases may occur and produce incorrect clearance indications. The designer should review all possible clearance displays when entering the pre-emption phase and add appropriate technical notes.
8. When a sequence that contains a dummy phase (e.g. flashing sign clearance) is pre-empted, the designer should consider the effects if and when the dummy phase is skipped. In these cases, the Signal Lab should be contacted (860-258-0347) to discuss the various possible impacts a pre-emption call could have on the overall signal sequence.
9. Settings and interval timings for all pre-emption movements shall be listed in the pre-emption settings block on the traffic signal plan. All the pre-emption data which will be programmed in the controller must be provided in this block. See **Figure 9-1**.
10. On the traffic signal plan add the technical note "Pre-Emption to be Inoperative During Flashing Operation".
11. If the traffic signal is maintained by the state and has EVPS, add the note "Emergency Vehicle Pre-Emption Equipment to be Owned and Maintained by the Town of (list town)" to the signal plan.
12. The town will be required to provide maintenance on all pre-emption equipment outside of the traffic controller cabinet.
13. Countdown pedestrian indications are allowed on Town owned signals. They cannot be used at a signal where multiple pedestrian movements are overlapped. In these cases the pedestrian clearance times may vary, giving inconsistent countdown times. At locations with countdown pedestrian indications in use, the pedestrian clearance interval shall not be allowed to be shortened for emergency vehicle pre-emption.

Sample Pre-emption Settings Block

	Railroad	Emergency Vehicle	Ramp
	PRE-EMPT 1	PRE-EMPT 2 (1)	PRE-EMPT 3 (1)
PRIORITY	YES	NO	NO
DET LOCK	YES	YES	YES
DELAY	0	0	0
ALT MIN GRN	0 (2)	5	5
ALT YELLOW	Parent	Parent	Parent
ALT RED	Parent	Parent	Parent
ALT PED CLR	NO (3)	(4)	(4)
(5)	TRACK CLR GRN	15	N/A
	TRACK CLR YLW	3.0	N/A
	TRACK CLR RED	2.0	N/A
	TRACK CLR PHASE	7	N/A
HOLD GREEN	10	15	(6)
HOLD YELLOW	3.0	3.0	3.0
HOLD RED	2.0	2.0	2.0
HOLD PHASE	8	2	4
EXIT PHASE	1	4	4
EXIT CALL	None	None	None

(Column headings and settings are for illustrative purpose only)

- (1) For locations which do not have railroad pre-emption, the emergency vehicle pre-emption settings are programmed in PRE-EMPT 1. If there is only ramp pre-emption, it is programmed as PRE-EMPT 1.
- (2) Determined on a case by case basis. Normally set at zero but can be greater based on vehicle approach speeds.
- (3) ALT PED CLR normally not provided, however in cases with handicap/elderly crosswalks or high speed roadways may be considered.
- (4) Select the actual pedestrian clearance time if there is an exclusive pedestrian phase, a concurrent pedestrian phase with walk/don't walk indications or a case where the pedestrian clearance time is used to operate a Stop Ahead sign.
- (5) When the signal is to hold in the track clearance phase for pre-emption, these intervals can be deleted and timings can be inserted in the hold timing blocks.
- (6) Sufficient time to clear the queue.

Figure 9-1 Sample Pre-emption Settings Block

Railroad Pre-Emption

Care should be taken when designing a traffic signal which is adjacent to a railroad crossing to preclude the possibility of a vehicle being trapped on the tracks. The method of actuation should be designed with adequate "Fail - Safe" features (a normally energized loop between the traffic signal control box and the railroad control box through a set of relays). Where crossings are 200 ft. (60 m) or less from a signalized intersection, railroad pre-emption will usually be required. At signalized intersections where the rail crossing is greater than 200 feet (60 m), but high vehicular volumes are expected, a queue analysis should be conducted to ascertain if pre-emption is required. Contact the Division of Traffic Engineering's railroad grade crossing section to determine extent of controls. Track circuit timings are developed by the Division of Traffic Engineering's railroad grade crossing section and track circuit designs are normally provided by the operating railroad.

Railroad Pre-emption Design Guidelines

1. Clearance out of normal operation to pre-emption shall follow ConnDOT traffic controller specifications.
2. Railroad pre-emption will require the use of a menu driven controller with internal pre-emption which will go directly into the pre-emption phase(s) which includes clearances.
3. Contact the Division of Traffic Engineering's railroad grade crossing section during the preliminary design to determine how pre-emption will be provided and what special requirements must be shown on the plan.
4. The actual sequence and signal displays for railroad pre-emption must be approved by the Division of Traffic Engineering's Electrical Unit and railroad grade crossing section; and the Department of Transportation's Signal Maintenance Lab.
3. Railroad pre-emption consists of two separate traffic control device actuations. When the train hits the approach circuit the first actuation is to the traffic signal controller, which immediately advances the sequence to the track clearance phase, via controller internal pre-emption. After a pre-determined period, the second actuation is to the railroad warning devices, which must operate for 29 seconds prior to the train entering the crossing. The traffic signal track clearance time, to enable vehicles to move off the tracks, must be complete prior to the activation of the railroad warning devices. The total track circuit time required is the traffic signal track clearance time, plus the 29 second railroad warning device timing.
4. Depending on the type and class of rail line, two different types of train operations can occur at a grade crossing. The first is a through move (traversing the crossing non-stop), and the second is a stop and protect (the train must come to a stop for a pre-determined time period before proceeding over the crossing). For stop and protect crossings controlled by a traffic signal, the controller is to provide 29 seconds of all-red clearance and way side signals shall be provided for the train which shall be part of the traffic signal operations.
5. Traffic signals containing railroad pre-emption will normally not be allowed to be placed on programmed flash. A technical note indicating that the "signal shall not be placed on programmed flash" should be added to the plan.

6. When a railroad crossing is located on the side street leg of a signalized intersection, the emergency flash or fail-safe flash should be all red. This will provide gaps in artery traffic for side street vehicles to clear off the railroad crossing.
7. Separate pre-emption sequences for pre-emption during fail-safe flash or emergency flash may be required depending on site conditions.
8. Traffic signals containing railroad pre-emption should be placed on Maintenance Level 1 (24-hour).
9. A railroad pre-emption track circuit timing block should be shown on the roadway portion of the signal plan. Railroad device operational notes should be added directly adjacent to the track circuit timing block describing the operation during normal and manual operation and the operation during flashing operation. See **Figure 9-2**.
10. A construction note should appear on the signal plan stating that the signal installer must coordinate with the operating railroad the installation of the pre-emption interconnect cable from the traffic signal control box to the railroad control box. Adjustments of the existing railroad track circuit and/or warning devices may be required depending on the railroad pre-empt design.
11. The pre-emption phase will be labeled "PRE-EMPT" along with a number, which indicates the priority level. For example a #1 is the highest priority followed by 2, 3 etc. Railroad pre-emption (if present) is always labeled as pre-empt number 1.
12. If the desired pre-emption phase is exactly the same as a normal phase in the sequence, that phase should be designated the railroad hold phase. If an illuminated turn restriction sign is required to be on during railroad pre-emption, but will not be on during normal operation then the pre-emption phase is not considered to be exactly the same.
13. If the desired pre-emption phase is not exactly the same as a normal phase, a separate phase must be added to the movement diagram and designated the hold phase (e.g. phase 8). The phase will be serviced only during the pre-emption movement. The mode should be On/Omit. This prevents the phase from being serviced after initialization or during manual operation. The hold green, yellow and red timings are shown in the phase as well as in the pre-emption settings block.
14. The use of non-standard overlaps (e.g. right-turn arrow) and dummy phases should be avoided in the sequence of a traffic signal that has railroad pre-emption. Incorrect clearance indications may be displayed and interval times may vary, which could violate the track circuit time requirements. Because any phase may be skipped, the designer should review all possible clearance displays when entering the pre-emption phase.
15. Settings and interval timings for all pre-emption movements shall be listed in the pre-emption settings block on the traffic signal plan. All the pre-emption data which will be programmed in the controller must be provided in this block. See **Figure 9-1**.

16. For railroad pre-emption a track clearance phase is usually required. This phase will be serviced immediately and will time the track clearance green, yellow and red intervals prior to the controller transferring to the railroad pre-emption hold phase (unless the track clearance phase is the railroad pre-emption hold phase). The track clearance settings and hold phase settings must be entered into Pre-empt 1. See **Figure 9-1**.
17. Some signals have provisions for pre-emption from fail safe flash and emergency flash, therefore the need for the technical note – "Pre-Emption to be Inoperative During Flash Operation" will be determined on a case by case basis.
18. The Department of Transportation will maintain railroad pre-emption equipment housed in the traffic control cabinet and also the cable, conduit, etc. up to the railroad control cabinet on State maintained traffic signals. The railroad maintains the track circuit and all the equipment in the railroad control cabinet.
19. Countdown pedestrian indications are allowed on Town owned signals. They cannot be used at a signal with railroad pre-emption or at a signal where multiple pedestrian movements are overlapped. In these cases the pedestrian clearance times may vary, giving inconsistent countdown times.

Railroad Pre-emption Track Circuit Timing Block

NOTE:

WHEN A PRE-EMPTION CALL IS RECEIVED DURING NORMAL OPERATION OR MANUAL OPERATION RAILROAD FLASHING LIGHTS WILL COMMENCE OPERATION __ TO __ SECONDS INTO PHASE _ DEPENDING UPON WHICH INTERVAL CONTROLLER IS IN WHEN RAILROAD PRE-EMPTION CALL IS RECEIVED. WHEN PRE-EMPTION OCCURS DURING EMERGENCY FLASH OR FAIL-SAFE FLASHING OPERATION, RAILROAD FLASHING LIGHTS WILL COMMENCE OPERATION__ SECONDS AFTER THE RAILROAD PRE-EMPTION CALL IS RECEIVED.

RAILROAD PRE-EMPTION	
TIME	EVENT
	START OF TRAFFIC SIGNAL PRE-EMPTION
	START OF RAILROAD FLASHING LIGHTS AND BELLS
	RAILROAD GATES START TO DROP
	RAILROAD GATES HORIZONTAL
	TRAIN ENTERS THE CROSSING

(Timings and Phase numbers to be entered in the railroad device operation notes and circuit timing block are to be determined for each specific location by the Division of Traffic Engineering's railroad liaison.)

Figure 9-2 Railroad Pre-emption Track Circuit Timing Block

Ramp Pre-emption

An expressway exit ramp may require a pre-emption movement to prevent the queue of exiting vehicles from backing up to the expressway mainline. A vehicle detector can be placed on the ramp to sense the presence of stopped vehicles and initiate the pre-emption movement which will hold in the ramp phase. Ramp pre-emption will invariably disrupt the normal signal operation possibly creating an arterial back-up as well. Any coordination with adjacent signals will also be interrupted. The designer should try to anticipate any adverse effects pre-emption will create. Inclusion of ramp pre-emption in the signal design should be judicious and only used when alternative measures have failed to address the situation. Other methods to prevent a back-up should be considered. These include, but are not limited to switching to a higher maximum green setting for the ramp phase, reducing the overall signal cycle length, utilizing volume density controller features such as TBR and TTR, providing an additional travel lane, or allowing right-turn on red. Ramp back-ups attributable to scheduled special events are generally handled more efficiently with police manual control rather than a ramp pre-emption system.

Ramp Pre-emption Design Guidelines

1. The design should be on a case-by-case basis. Each intersection may have unique characteristics that dictate the pre-emption settings. A ramp on an upgrade will move vehicles slower than a ramp on a downgrade. Adjacent intersections may also require pre-emption to clear the vehicles leaving the intersection.
2. The size and location of the detector area is critical for effective pre-emption. The loop should be long enough (typically 8 to 10 feet) so that a gap between two stopped vehicles does not cause the pre-emption call to be missed. The loop should be located far enough back to prevent unnecessary calls from vehicles that would normally clear during the phase green. The loop should be located close enough to accommodate ramp queues which will continue to build after the pre-emption detector is actuated. In determining the proper location for ramp detectors, the designer must consider the vehicle arrival rate on the off ramp and account for vehicles which will continue to accumulate at the back of the queue during the detector delay time, during the clearance interval for the signal phase being pre-empted, and during the time it takes for the last vehicle in the queue to start moving after the onset of green for the pre-emption phase.
3. A 10 to 12 second delay will typically prevent unnecessary false calls from slow moving vehicles or from a series of staggered vehicles on a two lane ramp. The delay feature of the loop detector amplifier should be used rather than a pre-emption setting.
4. When ramp pre-emption is used at locations which have EVPS, the designer must determine, in consultation with local officials, which pre-emption will have the higher priority.
5. The hold green time should be sufficient to clear the queue and enough vehicles to prevent successive pre-emption calls. If not set high enough, the pre-emption movement may prematurely terminate during a gap in the queue.

6. The ramp phase may also be designated as the exit phase. When the pre-emption movement terminates, the local detectors will extend the green as needed and therefore a lower hold green time may be used.
7. When the ramp signal is coordinated with other signals the designer must consider the effects of pre-emption on the system as well as the ramp. Also, if the intersection double-cycles, the ramp phase will have an excessive red time, creating another back-up, another pre-emption call, and another double cycle.

The above guidelines are written specifically to address queues on a signalized expressway off-ramp however the concepts can also apply to other situations where limiting the maximum queue length at a signalized location is critical to safe operation.

Pre-Emption Definitions

Confirmation Light

In an EVPS, the confirmation light provides a visual feedback to the emergency vehicle operator confirming the traffic signal is in a pre-emption movement. It is mounted in a conspicuous location such as high on a steel pole or on a mast arm assembly. A confirmation light may be used in railroad pre-emption also. At locations where pre-emption is frequent and/or false calls occur it provides a visual confirmation to DOT maintenance personnel. In this case it is mounted on top of the traffic control cabinet.

Parent Phase

For the purposes of pre-emption, it is the phase the controller is in when a call for pre-emption is received.

Pre-emption Movement (Pre-Emption Run)

A pre-emption movement is a series of intervals that provide the desired pre-emption sequence. Normal operation such as phase timing, vehicle detection, and coordination is suspended until the movement criteria are satisfied. A movement may consist of clearance intervals into and out of a pre-emption green. It also may consist of more than one phase such as phases 1 & 6 in a quad or a track clearance phase prior the hold phase.

Primary Response Route

The primary response route is the most common route taken by major fire apparatus from the fire station. The primary response route and the major fire apparatus are designated by the town when the fire run map is submitted.

Track Circuit (Approach Circuit)

The track circuit is a low voltage electrical system which senses the presence of an approaching train. The tracks and the train are used to complete the circuit. It is designed, owned and maintained by the railroad company. The length of the track circuit depends on the track clearance time needed, the railroad device warning time and the speed of the train.

Track Circuit Time

The total time needed to safely clear vehicles from the tracks and to activate and set the railroad warning devices (lights, bells, and gates) prior to the train entering the crossing. The track clearance time and railroad device warning time determines the length of the track circuit.

Track Clearance Time

The time needed to safely clear vehicles from the tracks. It is intersection specific and is programmed in the pre-emption settings as track clearance green, track clearance yellow and track clearance red.

Way Side Signal

Traffic signal head(s) located adjacent to the railroad right-of-way, facing the approaching train. Prior to the activation of pre-emption this signal is red. When the traffic signal is pre-empted and has completed the required track clearance and railroad warning times, the signal head facing the train will turn green authorizing the train to proceed over the crossing.

Pre-Emption Settings Definitions

Priority (yes/no)

When set to yes, a pre-emption call will override all other pre-emption calls (regardless of priority number). Railroad pre-emption is always yes. All other pre-emption movements are set to no and priority is determined by its number.

Detector Lock (yes/no)

If yes, a call that is dropped before the pre-emption movement begins will still be serviced. If no, a call that is dropped (for example, during a delay time or during a higher priority pre-emption) will not be serviced. To ensure the pre-emption sequence occurs when called, it is recommended to set Detector Lock to yes.

Delay (seconds)

The time between when the pre-emption call is received and the start of the pre-emption movement. Usually used with hardwire pre-emption where the emergency station is a distance from the signal. Typically a "zero" setting is used with optical or siren pre-emption.

Alternate Minimum Green (seconds)

The time for a green interval which is timing when pre-emption begins. For example, if the controller is 2 seconds into a green interval and the Alt. Min. Green is 5 seconds, then when pre-emption begins, the green will time down for 3 more seconds. Typical values would be 5 seconds for EVPS and 0 seconds for Railroad. Note - The setting selected will apply to all phases being pre-empted.

Alternate Yellow (seconds)

The interval time for yellow which is timing when pre-emption begins. **Parent** can be selected to time down the yellow value in the parent phase or timing can be selected to have an alternate yellow time. Under normal circumstances use **Parent**. In situations with signals that have quad left-turn phasing, selecting **Parent** will provide the yellow interval associated with the left-turn phase of the quad (i.e. Phase 1 if timing with Phase 6). The designer should ensure the yellow interval selected is adequate for all of the movements associated with the quad.

Alternate Red (seconds)

The interval time for red which is timing when pre-emption begins. **Parent** can be selected to time down the red value in the parent phase or timing can be selected to have an alternate red time. Under normal circumstances use **Parent**. In situations with signals that have quad left-turn phasing, selecting **Parent** will provide the red interval associated with the left-turn phase of the quad (i.e. Phase 1 if timing with Phase 6). The designer should ensure the red interval selected is adequate for all of the movements associated with the quad.

Alternate Pedestrian Clearance (seconds)

The interval time for PED CLR which is timing when pre-emption begins.

- If there is no exclusive pedestrian phase, select NO. This will result in a zero setting in most controllers.

- If there is an exclusive pedestrian phase, a concurrent pedestrian phase with walk/don't walk indications or a case where the pedestrian clearance time is used to operate a Stop Ahead sign, select the actual pedestrian clearance time.
- In special cases such as railroad pre-emption from an exclusive pedestrian movement a lower pedestrian clearance time may be selected.

Track Clearance Green (seconds)

The time for which a green indication is maintained in the track clearance phase.

Track Clearance Yellow (seconds)

The time for which a yellow indication is maintained in the track clearance phase.

Track Clearance Red (seconds)

The time for which a red indication is maintained in the track clearance phase.

Track Clearance Phase (1-8)

If needed in a railroad pre-emption movement, this phase will be serviced immediately prior to the hold phase.

Hold Green (seconds)

The minimum guaranteed green time in the pre-emption phase. The actual Hold Green time depends on the presence of the pre-emption call. As commonly occurs in an optical EVPS or a railroad pre-emption movement, the phase remains on long after the programmed hold green time is over.

Hold Yellow (seconds)

The time for which a yellow indication is maintained in the pre-emption phase.

Hold Red (seconds)

The time for which a red indication is maintained in the pre-emption phase.

Hold Phase (1-8)

This is the pre-emption phase(s).

Exit Phase (1-8)

The phase(s) that will follow the pre-emption phase(s). A phase number must be selected in all cases. The selected exit phase will always follow the pre-emption phase regardless of vehicle/pedestrian calls.

Exit Call (1-8 or NONE)

The phase(s) that will have a vehicle or pedestrian call when the pre-emption terminates. Vehicle phases in lock mode and pedestrian phases retain calls that are present before pre-emption and received during pre-emption. Vehicle phases in non-lock have presence detection and will be called if there is a demand. Since the controller will serve these calls when pre-emption is released, specifying exit calls is normally not necessary. Only non-actuated phases, such as internal clearances, should be selected.

10 TRAFFIC SIGNAL EQUIPMENT

In designing a traffic control signal, it is important that the signal indications are clearly visible to intended motorists and pedestrians and that the support structures are located to minimize the impact on utilities. The location of traffic signal appurtenances should not pose a fixed object hazard, create an intersection or driveway sight distance restriction, block visibility between pedestrians and approaching vehicles or be aesthetically offensive to an adjacent development. Placement of controller cabinets should be protected where possible.

Signal Head Location

Signal head location has an effect on crash potential and operational efficiency. Signal heads should be placed for optimum visibility during critical pedestrian/vehicular movements and be readily identifiable with the approach which they control. Head placement should focus a driver's attention to the front and the side rather than cause the driver to look up. Studies have suggested that far side placement will accomplish this and therefore, far side signal faces are preferred. Signal heads can be mounted on either span wire, mast arms or side mounted on pedestals/steel span poles. Two signal faces should be visible to the driver of an approaching vehicle for the minimum sight distance as described in section 4D.12 of the Manual on Uniform Traffic Control Devices for Streets and Highways (MUTCD). Auxiliary signs and signal heads must be considered when the visibility to the signal heads is unsatisfactory for pedestrians or vehicles.

Lateral Placement

A minimum of two signal heads shall be provided for each approach. The primary signal head should normally be located in line with, or to the right of, the far-side centerline of an undivided two-way road for each direction of travel. Secondary signal heads may then be located according to the most feasible span arrangement. When signal heads for multiple approaches are located on the same span, all signal heads shall be placed a minimum of 3-feet apart measured between attachment points. However, signal heads for any one approach shall be mounted no less than 8 feet apart and should be no more than 20 feet apart, measured horizontally and perpendicular to the line of approaching traffic. It is preferable to mount signal heads over the center line/lane lines rather than centered over the lane itself as this lessens the chances that the indications could be blocked by trucks. An auxiliary indication may be located left of the centerline if the intersection geometry restricts visibility to the primary signal face.

When a signal face controls a specific lane(s), its position should make it readily visible to drivers making that movement, such as with exclusive left-turn control. Left-turn signal faces should be visible up to the point where the turn is executed.

Longitudinal Placement

At least one and preferably all of the signal faces required should be located within the range of 40 to 180 feet from the stop bar. Where the width of the intersection requires that the nearest signal face be placed 150-180 feet from the stop bar, a supplemental near-side signal face may be located at or near the stop bar. If a signal head is 180 feet or more from the stop bar, then a supplemental signal face is required. Refer to Section 4D.14 of the MUTCD for signal head placement.

Special Applications

Signal heads may be mounted horizontally to provide greater visibility for a vehicle approaching from an underpass. Horizontally mounted signal heads may be suspended lower than normal when the obstruction sets the minimum vertical clearance for the roadway. If the signals are allowed to be less than 16 feet, they must be positioned so that no vehicles, other than those on the underpass approach, pass under them. This may preclude a far-side signal placement.

Under some circumstances, where either vertical or horizontal sight line to the overhead signals is restricted, pedestal/pole mounted signal heads can provide added visibility. These signal heads are usually provided in addition to the two overhead signal heads.

At times, stop bars must be located further from an intersection than is customary. Whenever it is important that a vehicle should stop further from an intersection, the signal faces for that approach should be located so that motorists are kept at the proper stop position and not inclined to creep forward. This may preclude a far-side signal placement.

It may be necessary to control vehicles at a point in advance of an intersection due to geometric situations. Examples would be an intersection preceded by a sharp break in grade, sharp horizontal curve, sight line obstruction located close to the roadway, or in advance of railroad tracks close to the intersection. The signal heads located in advance of an intersection should stop all traffic with an internal clearance phase between that point and the intersection to clear any vehicles before the customary intersectional heads display yellow and red.

A “Signal Ahead” symbol warning sign shall be erected for all major street approaches to an intersection if approaching traffic does not have a continuous view of at least two signal faces, for at least the minimum sight distance as referred to in Chapter 4D of the MUTCD, in order to warn approaching traffic of the signal. Flashing lights may be installed on these signs to emphasize the message. Additionally, some of the previously noted applications may require the installation of flashing message signs. See Chapter 14 (Flashing Message Signs) for further details.

Visual Shielding Devices

In cases where intersection alignment results in a comparatively small angle between the orientation of signal lenses on intersecting approaches, each signal lens shall be shielded. Tunnel visors and/or louvers can usually provide sufficient screening. If louvers are required, the characteristics of both straight vane louvers and cut-off louvers should be considered. The guidelines on **Figure 10-1** may be used to determine screening types.

Visors

The standard visor that is attached to each signal section is the partial visor or cap visor, which is open on the bottom to allow visibility to a driver passing beneath or a pedestrian on the side of the road. Unless otherwise specified, the signal indications shall have cap visors. Tunnel visors may be used to screen the signal indication from an adjacent approach. Full circle visors are not used by the Department.

Louvers

Louvers may be inserted in a tunnel visor to provide a narrow cone of visibility. The most common type used by the Department is the 5 vane cut-off type. The vanes are angled 7 degrees and limit the visibility more on one side than the other. The designer must indicate which direction is cut-off, left or right. For example: if the vehicles to the right of the approach should not see the indication, the louvers are described on the plan as cut-off right. Louvers are not used on arrow indications.

Visibility Limiting Signals

Visibility limiting signals, which are optically programmed indications, are also an acceptable method of screening. These signals restrict visibility to the traffic in a specific lane and/or at a specified distance from the signal. Unlike conventional louvers and visors, optically programmed signals do not reduce the light intensity of the display. Optically directed signals provide an optical cut-off of the indication, both vertically and horizontally as needed. Satisfactory operation of visibility limiting signals depends on correct alignment. Therefore, the signal head should be mounted on a rigid support rather than a span wire. With the use of an optically programmed signal, a sight triangle must be shown on the signal design plan to indicate the cone of visibility to the indication.

Backplates

Backplates shall be attached to all vehicular signal head housings on all new spans. The backplate is a flat black rectangular frame surrounding the signal head, which extends 5-inches beyond all sides of the signal head and shall have a 2-inch yellow retro-reflective strip (Type IV sheeting) along the perimeter of the face of the backplate. Due to the use of backplates, signal head clusters are only allowed when the signal heads are angled at least 120 degrees apart.

In cases where the intersection alignment results in a comparatively small angle between the orientation of signal lenses on intersecting approaches, each signal lens should, to the extent practical, be shielded by visors, louvers, or other means. The following guidelines can be used as an aid in determining the type of visibility limiting device to be used.

Case I - 35° or less

Tunnel visors with louvers should be considered.

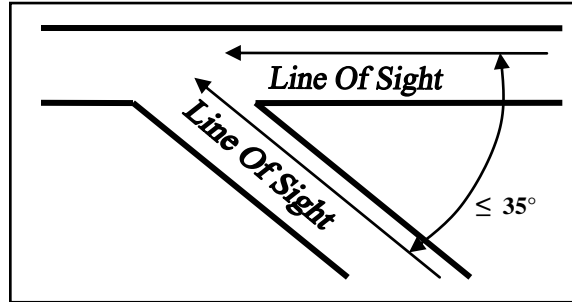

Case II – between 35° & 65°

Tunnel visors should be considered.

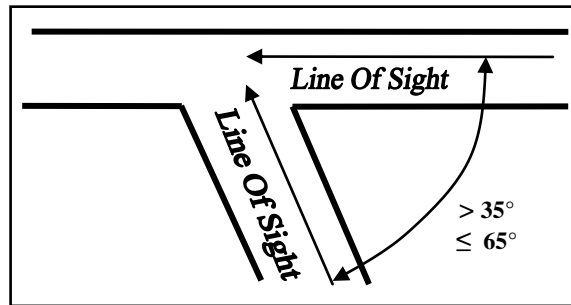

Case III – between 65° & 90°

The use of shielding devices is not typically required.

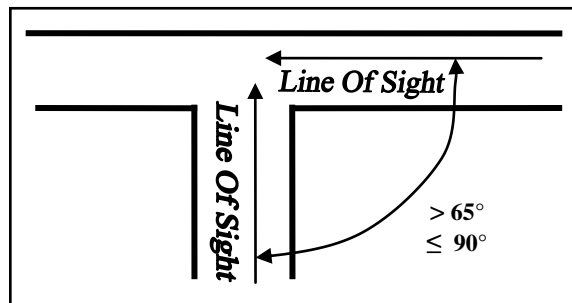

Note:

At locations where the alignment of a roadway approach is generally tangent, the line of sight for the approaching vehicle can be considered parallel to the roadway centerline on the approach.

Figure 10-1 Types of Visibility Limiting Devices

Signal Lens Size and Type

All signal lenses, except for exclusive pedestrian indications, are circular. For information on size of exclusive pedestrian indications refer to CTDOT Standard Sheet TR-1102_01. There are two sizes for circular lenses, 8 inch and 12 inch. Signal indications and pedestrian indications are typically illuminated by light emitting diode (LED) lamps.

1. 12 inch lenses will normally be used.
2. 8 inch lenses may be used under the following conditions:
 - a. When pedestrian indications are provided for crossing on side street green, every effort should be made to pedestal or pole mount these indications for better visibility by the pedestrian.
 - b. When signals are installed at two closely spaced intersections, it is desirable to provide simultaneous yellow indications followed by simultaneous red indications. If that cannot be reasonably accomplished, the signal heads which are nearest the approaching driver should be clearly distinguishable from those that are farthest away. Providing 12 inch lenses on the nearest set of indications and 8 inch lenses on those farthest away may provide this contrast.

Signal Support Structures

Type

Generally, at least two support structures are needed in order to locate the signal heads as previously described. The most common types are a span pole or a mast arm assembly. Utility poles can be used in combination with span poles to support signal heads. A span pole is a pole to which span wire is attached for the purpose of supporting the signal heads. A mast arm assembly is a cantilever structure that permits the overhead installation of the signal heads without overhead span wire and signal cables. Combination structures (either span pole or mast arm assembly) are used to support a luminaire as well as the signal heads. The support must be strong enough to sustain the weight of the signals and cables and tall enough to provide a minimum signal housing clearance of 16 feet from the road surface. The support is made of steel, in accordance with current AASHTO Standard Specifications. The support is bolted to a reinforced cast-in-place concrete foundation.

For temporary installations, a wood pole other than a utility pole can be used to support a span wire and cannot be used for a permanent installation. If a wood pole is used, there must be sufficient right-of-way for an anchor and guy opposite the span.

Placement

The major factors to consider when determining a support location are optimal signal head placement, safety for vehicles and pedestrians, clearance to utilities (overhead and underground) and aesthetics. After installation, the support may be in place for 20 years or more before a re-design and therefore, the designer should carefully consider all factors.

The current far-side signal design practice suggests a support on each corner of the intersection which enables excellent lateral and longitudinal signal head and sign placement.

A typical support cannot be designed as breakaway and is therefore considered a fixed object and should be located to minimize the possibility of being struck by an errant vehicle. Supports should be set, if possible, behind any existing protective device already at the intersection, such as guide rail and beyond the deflection limit of the device. Where right-of-way will allow, the supports should be set outside the clear zone. Refer to the Department's *Highway Design Manual* (reference 2) for recommended clear zone distances.

Supports at the side of a street shall have a horizontal clearance of not less than 2 feet from the vertical face of a curb or the edge of the road where curb is not present. Supports should not be located opposite the stem of a T-type intersection. Also, supports should not be located in areas which are likely to contain a driveway if the property opposite the stem of the "T" is developed. Supports and pedestals, should not obstruct a crosswalk or sidewalk. A free path not less than 4 feet must be available for pedestrians in accordance with the requirements of the Public Right of Way Accessibility Guidelines. In addition to not creating a fixed object for motorists and pedestrians, the designer should not create a sight line obstruction. When supports are placed in line with other objects such as pedestals, controller cabinets and utility poles, it may obstruct intersection sight distances.

There are usually utilities, both overhead and underground, that the designer must consider when locating a support. There are certain clearances that must be met for safety reasons. The utility issues are discussed in depth in Chapter 15 (Electrical Considerations) of this manual.

In keeping with context-sensitive design practice, the designer should consider the area where a proposed support and other large signal appurtenances will be installed. Some of the more common areas to be avoided are the following locations:

- in front of a business/municipal sign
- in front of a business or residence entrance
- in the front yard of a residence
- in front of a historical building
- in a landscaped area

Finish

All steel supports are hot dipped galvanized to prevent corrosion. When new, the finish has a silvery shine. Over time, the finish oxidizes to a light gray. When a support is placed in an architectural streetscape setting, the pole may be painted after galvanizing to match other structures. Ornamental hardware such as covers and caps are available and have been used by several municipalities in downtown areas. If a municipality desires a colored support or ornamental hardware at an existing State owned intersection, the State will not participate in funding the cost of those appurtenances. If a colored support or ornamental hardware is being installed at locations in projects, such as new installations, the cost is funded in the project. In either case, the municipality must also enter into an agreement with the State to assume the maintenance responsibility for the paint and any ornamental hardware. It should be noted that a painted or ornamental structure that has been damaged will be replaced by the Department with standard, in-stock equipment and not with one of the same type.

Use of Utility Poles

There are often utility poles on the corners of an intersection. It is an acceptable practice to attach a span wire to a utility pole rather than installing another support. When attaching to utility poles there are certain Public Utilities Regulatory Authority (PURA) regulations, National Electric Safety Code (NESC) clearances, and Occupational Safety and Health Administration (OSHA) regulations that must be followed. There is additional information on this in the Utility Considerations section of Chapter 15 (Electrical Considerations) of this manual. The utility pole must be anchored and guyed opposite the span and therefore, sufficient right-of-way must be available. Any attachment to a utility pole must be discussed with and agreed to by the utility companies. The location of utility poles is generally determined by the custodian. The designer may request a more desirable location for a utility pole, however, this could be costly if that also requires the re-design and replacement of the nearby power distribution system and communication circuits.

Span Wire Design Guidelines

It is required that the designer confer with municipal officials prior to designing an intersection to determine which type of support is desired. Span wire is the preferred method of signal support. There are several types of span designs. In keeping with the current DOT practice of far-side signals, the following span designs are listed in descending order of the preferred methods to provide the best signal mounting positions:

- Box Span
- Triangle Span
- V Span
- Y Span
- Straight Diagonal Span

Support locations for a box span design are not as critical as a three pole span. The box span is intended for far-side signal placement. The signal assemblies are usually one-way which may be moved easily to account for a poor pole location. When designing a box span, no more than two Y points should be used. If two are used, they should be on diagonally opposite corners only.

For straight diagonal spans at large intersections, a straight span length may exceed 180 feet which requires a high attachment point and possible replacement of adjacent utility poles. The straight diagonal span does not generally allow far-side signal placement on all approaches, likely necessitating the provision of a pedestal or span pole mounted signal head on the far left corner for approaches that allow left-turn maneuvers. Support locations for a V, triangle and Y span are not as critical as a straight diagonal span. The center Y point may be located almost anywhere within the intersection. When designing a Y-type span, the distance X must be at least 5% of the distance Z as shown in **Figure 10-2**.

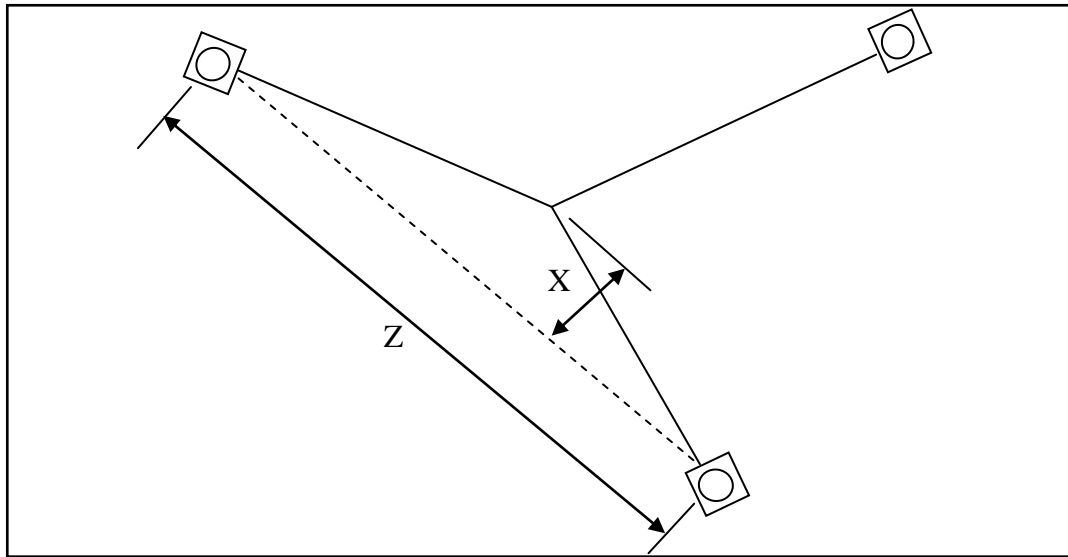

Figure 10-2 Y-Type Span Signal Support

The latest edition of the AASHTO Standard Specifications for Structural Supports for Highway Signs, Luminaires, and Traffic Signals – along with the latest interim specifications, govern the structural design of all steel span poles and combination span poles in Connecticut, State-owned and town-owned. Sample span pole guide sheet details and special provisions are available on the Department’s website. The criterion for span pole designs and span pole foundation designs varies depending on the ownership of the traffic signal as well as the ownership of the roadway. Three cases are presented below:

- a. Span poles at State-owned signals must conform to the Department’s typical span pole design and span pole foundation design as reflected on the latest guide sheets and special provisions.
- b. Span poles at town-owned signals on State roads must utilize the Department’s typical span pole foundation design. The town may use its own span pole design as long as the design conforms to the latest AASHTO standards.
- c. Span poles at town-owned signals on town roads do not need to use the Department’s typical span pole design or the Department’s standard span pole foundation design. The town/city may elect to use these for their design, however, they may also use their own typical installation sheets and special provisions for the span poles and foundations provided they conform to the latest AASHTO standards.

Span pole lengths are typically between 26 feet and 34 feet in 2-foot increments. Refer to the Department’s Master Bid Item List for standard span pole lengths to be used. Determination of span pole lengths shall follow the procedure described in Chapter 15 (Electrical Considerations) of this manual.

For “in-house” designs, the Traffic Project Engineer should send the traffic control signal plan(s) to Bridge Design for review. Bridge Design will provide the signed guide sheets and special provisions for the span pole assembly(ies) for the project.

The procedure for consultant engineers for proposed span poles is documented below:

DESIGN PHASE:

1. The Consultant Engineer shall review the sample guide sheets and special provisions for the span poles and foundations that are available on the Department's website.
2. For b and c listed above, the Consultant Engineer revises the guide sheet details and special provisions as appropriate.
3. The Consultant Engineer signs the guide sheets included in the plan set. The title sheet or individual plans must be sealed by a Professional Engineer, licensed in the State of Connecticut.
4. The Consultant Engineer submits the guide sheet details (plans) and special provisions for the span poles along with the signal plan as part of the design submissions to the Department for review. For a project, if needed, Bridge Consultant Design will be asked to review the span pole documents, and for a permit review, if needed, Bridge Design will be asked to review the span pole documents. Typically, the Bridge Office would only need to perform a review for some cases for item 2 above, however there may be other situations in which their review will be needed.
5. The Department (Division of Traffic Engineering, District Permit Office, and Bridge Consultant Design or Bridge Design if applicable) reviews and provides comments on the design submission(s).
6. After the Department has no further comments on the signal plan and span pole documents, the project can proceed to the construction phase. It is important that the above steps be completed during the design phase prior to construction to ensure that the Contractor has all of the necessary plans and special provisions prior to designing the span poles and foundations and preparing the working drawings.

CONSTRUCTION PHASE:

7. The Contractor submits the working drawings and design computations in accordance with the special provisions to the Consultant Engineer.
8. The Consultant Engineer reviews the working drawings for conformance with the design criteria specified in the plans and special provisions. For b listed above, the Department (Bridge Consultant Design for projects and Bridge Design for permits) may need to be included in the review of the working drawings.
9. The Consultant Engineer stamps the working drawings as review completed with comments as applicable.
10. The Consultant Engineer provides copy(ies) of the stamped/reviewed working drawings to the Department.

Existing Span Pole Assemblies

It is the current Department design practice that if there are any changes to the existing conditions such as additional loads applied to the existing span poles, the latest AASHTO standards shall be implemented for analyzing the existing structures. For span poles that were

fabricated prior to the design procedure described above (i.e. that utilize 4 anchor bolts), this may require a complete redesign of the traffic support system, as the new code requirements include more stringent guidelines for analyzing the effects of wind loads. A structural analysis of the existing span pole assemblies shall be conducted by a Professional Engineer licensed in Connecticut. For internal reviews requiring assessments of span poles or a proposed change in span loading, requests should be sent to Bridge Safety & Evaluation or Bridge Design, respectively. The analysis should include consideration of, but may not be limited to, the following elements:

- Age of span poles
- Standard sheets and design details used for construction of span poles (if available*)
- Working drawings for construction of span poles (if available*)
- Determination if the proposed loading will exceed the existing loading of the span poles (Refer to the Structural Design for Span Poles section of Chapter 15)
- Orientation of anchor bolts to proposed resultant load (Refer to previous Standard Sheet TR-1103_01*)
- Modifications that result in increased load effects to an existing span pole structure and configuration may be found acceptable provided the following conditions are met:
 - The existing structure(s) and foundation(s) is(are) in good condition. Condition assessment may include, but not be limited to, the condition of welds and the following foundation items:
 - Scale or spalling exposing large areas of rebar
 - Rebar with section loss
 - Open cracks (especially those going to anchor bolts)
 - Signs of settlement
 - The D-meter readings of the pole at 2", 6" and 24" above the baseplate indicate no section loss.
 - The structure has not sustained any impact damage.
 - The modified span pole structure and configuration shall conform to requirements of either of the following:
 - The latest edition of the AASHTO Standard Specifications for Structural Supports for Highway Signs, Luminaires and Traffic Signals, including the latest interim specifications, amended as follows:

The wind load shall be determined in accordance with Article 3.8. Wind pressures may be determined in accordance with Appendix C.
 - The latest edition of the AASHTO LRFD Specifications for Structural Supports for Highway Signs, Luminaires, and Traffic Signals, including the latest interim specifications.

*Request information from the Division of Traffic Engineering

Examples of additional loads include, but are not limited to, the following:

- Additional signal head
- Revising a 3 section to a 5 section
- Revising a 1-way to a 2-way
- Shifting an existing signal head
- Additional span-mounted signs

If there is a proposed change that would cause a reduction in load or if the proposal is to replace in kind (no change in load) and provided that the span pole is in good condition, then an analysis could be waived. Determination of pole condition is based on an inspection of both the span pole and span pole foundation. The inspection should include the elements listed in the structural analysis section above.

Mast Arm Design Guidelines

The use of a mast arm assembly rather than a span pole depends on one or more factors. The following conditions suggest consideration of a mast arm design:

- Overhead conflicts with utilities
- Adjacent intersections are mast arm design.
- Mast arms are requested by a municipality.
- Lack of right-of-way prevents the anchoring of a utility pole or prevents the installation of a pole on one side of the street.

It is required that the designer confer with municipal officials prior to designing an intersection to determine which type of support is desired. Local opinions regarding the aesthetics of a mast arm design vary widely from municipality to municipality. If a mast arm is chosen for the support structure, a design using fixed-mounted signals is preferred. Under certain circumstances, a free-swinging design may be necessary.

A mast arm design eliminates most potential overhead conflicts with utilities. Unless it is a combination structure, the height is low enough not to conflict with primary wires. Because the arm is usually 18 to 20 feet over the road, the designer should be most concerned with communication cables which are at the same elevation.

Each mast arm structure is assigned an identification number. It consists of the state intersection number with a letter suffix. It is used to identify the structure for inspection and maintenance purposes. Mast arm information which lists the ID number, shaft height, and arm length is placed on the signal plan as shown in **Figure 16-7**.

The designer must establish the arm length and arm attachment point. The arm attachment point varies based on the difference in elevation between the foundation and the high point of the road under the arm. The shaft height is a function of fabricator's design as noted on the Bridge Design guide sheets and should not be shown on the mast arm profile except where luminaire or camera extension brackets are proposed. Round up to the nearest foot.

A profile and a plan view of each mast arm assembly must be developed. The profile view should illustrate the structure, foundation, and signal heads in relation to the road. The view shall be perpendicular to the arm and should also show any other traffic appurtenances (signs, luminaries, cameras, etc.) supported by the mast arm assembly as well as the dimensions from the centerline of the base of the shaft to each traffic appurtenance mounted to the shaft. Include the width, height, and weight of any signs attached to the mast arm assembly. Sheet aluminum sign weight, including mounting hardware, is based on 4 lbs./sq. ft. The mast arm structure identification number should be shown on the profile. An example profile view is shown in **Figure 10-3**.

The plan view is an overhead illustration of the mast arm assembly showing all traffic appurtenances attached to the arm and the distance from each to the centerline of the shaft. The plan view should also include an edge of road reference. An example plan view is shown in **Figure 10-4**.

If there is enough space on the signal plan under the construction notes, the profile and plan view may be shown there. If not, the profile and plan view should be shown on a separate plan sheet.

The latest edition of the AASHTO Standard Specifications for Structural Supports for Highway Signs, Luminaries and Traffic Signals – along with the latest interim specifications, govern the structural design of all mast arm assemblies in Connecticut, State-owned and town-owned. Sample mast arm guide sheet details and special provisions are available on the Department’s website (see Structure/Bridge Standard Drawings). It is preferred that mast arms at State owned signals not exceed 40 feet in length. The criterion for mast arm designs and mast arm foundation designs varies depending on the ownership of the traffic signal as well as the ownership of the roadway.

Three cases are presented below:

- a. Mast arm assemblies at State-owned signals must conform to the Department’s typical mast arm design and mast arm foundation design as reflected on the latest guide sheets and special provisions.
- b. Mast arm assemblies at town-owned signals on State roads must utilize the Department’s typical mast arm foundation design. The town may use its own mast arm design as long as the design conforms to the latest AASHTO standards.
- c. Mast arm assemblies at town-owned signals on town roads do not need to use the Department’s typical mast arm design or the Department’s standard mast arm foundation design. The town/city may elect to use these for their design, however, they may also use their own typical installation sheets and special provisions for the mast arms and foundations provided they conform to the latest AASHTO standards.

For “in-house” designs, the Traffic Project Engineer should send the traffic control signal plan(s) including the profile and plan view of each mast arm assembly to Bridge Design for review. Bridge Design will provide the signed guide sheets and special provisions for the mast arm assembly(ies) for the project.

The procedure for consultant engineers for proposed mast arm assemblies is documented below:

DESIGN PHASE:

1. The Consultant Engineer shall review the sample guide sheets and special provision for the mast arm assembly (MAA) that are available on the Department's website.
2. The Consultant Engineer revises the sample special provision to provide the consultant's contact information for the working drawing submission.
3. For b and c listed above, the Consultant Engineer revises the guide sheet details and special provisions as appropriate. This includes revisions and supporting design calculations needed to account for longer mast arms, larger signs, internally illuminated signs, etc.
4. The Consultant Engineer signs the guide sheets included in the plan set. The title sheet or individual plans must be sealed by a Professional Engineer, licensed in the State of Connecticut.
5. The Consultant Engineer submits the guide sheet details (plans), special provisions, and design calculations (if applicable) for the MAA along with the signal plan as part of the design submissions to the Department for review. For a project, if needed, Bridge Consultant Design will be asked to review the MAA documents, and for a permit review, if needed, Bridge Design will be asked to review the MAA documents. Typically, the Bridge office would only need to perform a review for some cases for item 3 above, however, there may be other situations in which their review will be needed.
6. The Department (Division of Traffic Engineering, District Permit office, and Bridge Consultant Design or Bridge Design if applicable) reviews and provides comments on the design submission(s).
7. After the Department has no further comments on the signal plan and MAA documents, the project can proceed to the construction phase. It is important that the above steps be completed during the design phase prior to construction to ensure that the Contractor has all of the necessary plans and special provisions prior to designing the MAA and preparing the working drawings.

CONSTRUCTION PHASE:

8. The Contractor submits the working drawings and design computations in accordance with the special provision to the Consultant Engineer.
9. The Consultant Engineer reviews the working drawings for conformance with the design criteria specified in the plans and special provisions. For b listed above, the Department (Bridge Consultant Design for project and Bridge Design for permit) may need to be included in the review of the working drawings.
10. The Consultant Engineer stamps the working drawings as review completed with comments as applicable.
11. The Consultant Engineer provides copy(ies) of the stamped/reviewed working drawings to the Department.

Existing Mast Arm Assemblies

It is the current Department design practice that if there are any changes to the existing conditions such as additional loads applied to the existing mast arms, the latest AASHTO standards shall be implemented for analyzing the existing structures. This may require a complete redesign of the traffic support system as the new code requirements include more stringent guidelines for analyzing the effects of wind loads. A structural analysis of the existing mast arm assemblies shall be conducted by a Professional Engineer licensed in Connecticut. For internal reviews requiring assessments of mast arm assemblies or proposed changes in loading, requests should be sent to Bridge Safety & Evaluation or Bridge Design, respectively. The analysis should include consideration of, but may not be limited to, the following elements:

- Age of mast arm assemblies
- Standard sheets and design details used for construction of mast arm assemblies (if available*)
- Working drawings for construction of mast arm assemblies (if available*)
- Determination if the proposed loading will exceed the existing loading of the mast arm assemblies
- Modifications that result in increased load effects to an existing mast arm assembly and configuration may be found acceptable provided the following conditions are met:
 - The existing structure(s) and foundation(s) is(are) in good condition. Condition assessment may include, but not be limited to, the condition of welds and the following foundation items:
 - Scale or spalling exposing large areas of rebar
 - Rebar with section loss
 - Open cracks (especially those going to anchor bolts)
 - Signs of settlement
 - The D-meter readings of the pole at 2", 6" and 24" above the baseplate indicate no section loss.
 - The structure has not sustained any impact damage.
 - The modified mast arm assembly and configuration shall conform to requirements of either of the following:
 - The latest edition of the AASHTO Standard Specifications for Structural Supports for Highway Signs, Luminaires and Traffic Signals, including the latest interim specifications, amended as follows:

The wind load shall be determined in accordance with Article 3.8. Wind pressures may be determined in accordance with Appendix C.
 - The latest edition of the AASHTO LRFD Specifications for Structural Supports for Highway Signs, Luminaires, and Traffic Signals, including the latest interim specifications.

*Request information from the Division of Traffic Engineering

Examples of additional loads include, but are not limited to, the following:

- Additional signal head(s)
- Revising a 3 section to a 5 section
- Revising a 1-way to a 2-way
- Shifting an existing signal head away from the mast arm vertical shaft
- Additional sign(s)

If there is a proposed change that would cause a reduction in load or if the proposal is to replace in kind (no change in load) and provided that the mast arm is in good condition, then an analysis could be waived. Determination of mast arm condition is based on an inspection of both the mast arm assembly and mast arm foundation. The inspection should include the elements listed in the structural analysis section above.

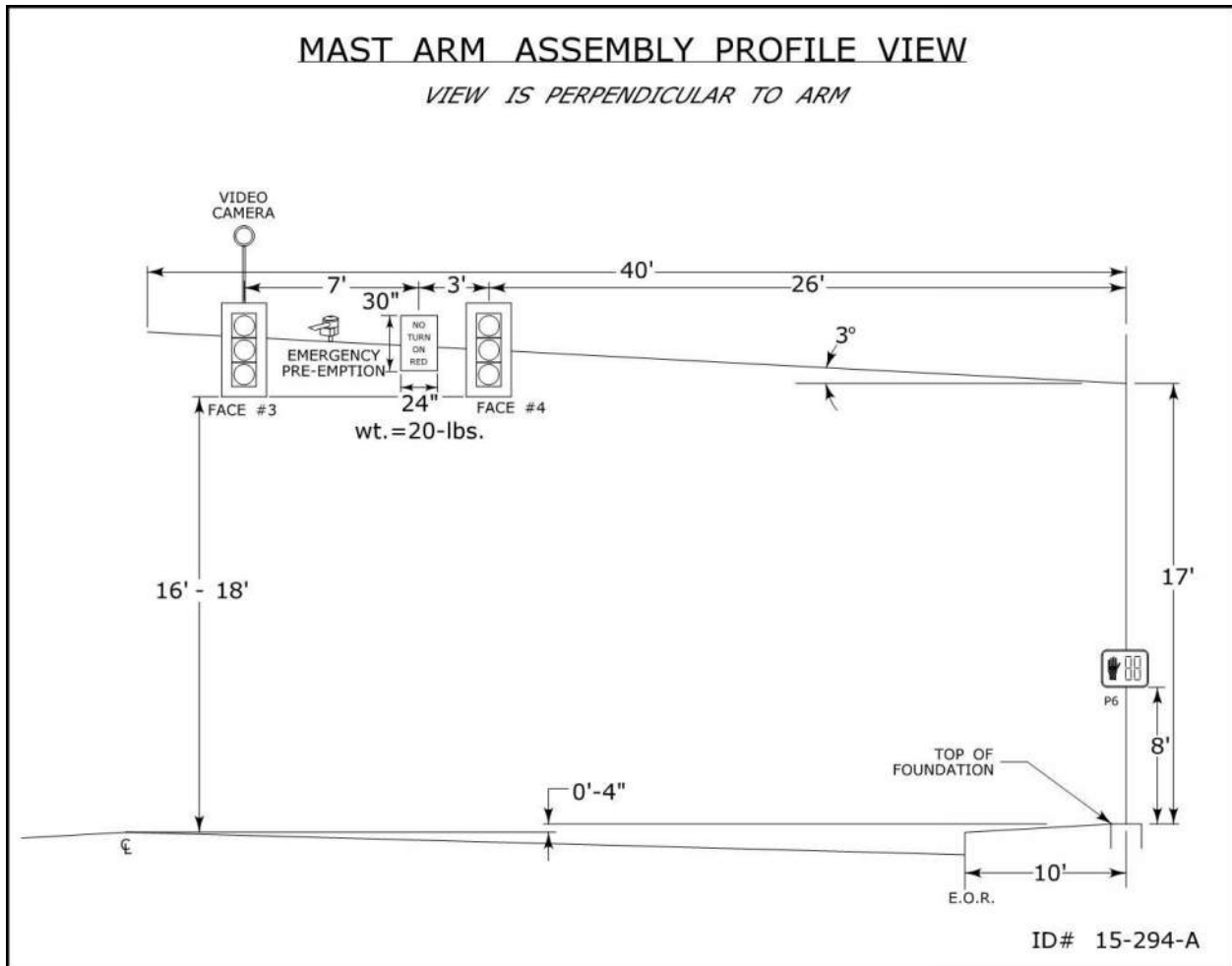

Figure 10-3 Mast Arm Assembly Profile View

Example: Determine the attachment point and shaft height of a 40 foot mast arm. The height (clearance) to bottom of signal housing at high point of road is 17 feet. Note: A signal clearance of at least 16 feet over the road should be provided.

- A fixed mounted signal design requires the arm to be positioned behind the center of the signal assembly. Therefore, the arm height should be 17 feet + half the height of the largest signal, which in the example equals 19 feet. It should be noted that a free swinging signal design requires the arm to be 1 foot above the signal assembly.
- Establish the vertical rise of the arm = $\text{Sine } 3^\circ \times \text{arm length} = 0.052 \times 40 \text{ feet} = 2 \text{ feet}$.
- Calculate the attachment point of the arm = $\text{Arm height} - \text{vertical rise} \pm \text{foundation height in relation to the road} = 19 \text{ feet} - 2 \text{ feet} - 0.33 \text{ feet} = 16.67 \text{ feet} \approx 17 \text{ feet}$
- The shaft height should be 1.5 feet higher than the calculated attachment point = $17 \text{ feet} + 1.5 \text{ feet} \approx 18.5 \text{ feet}$

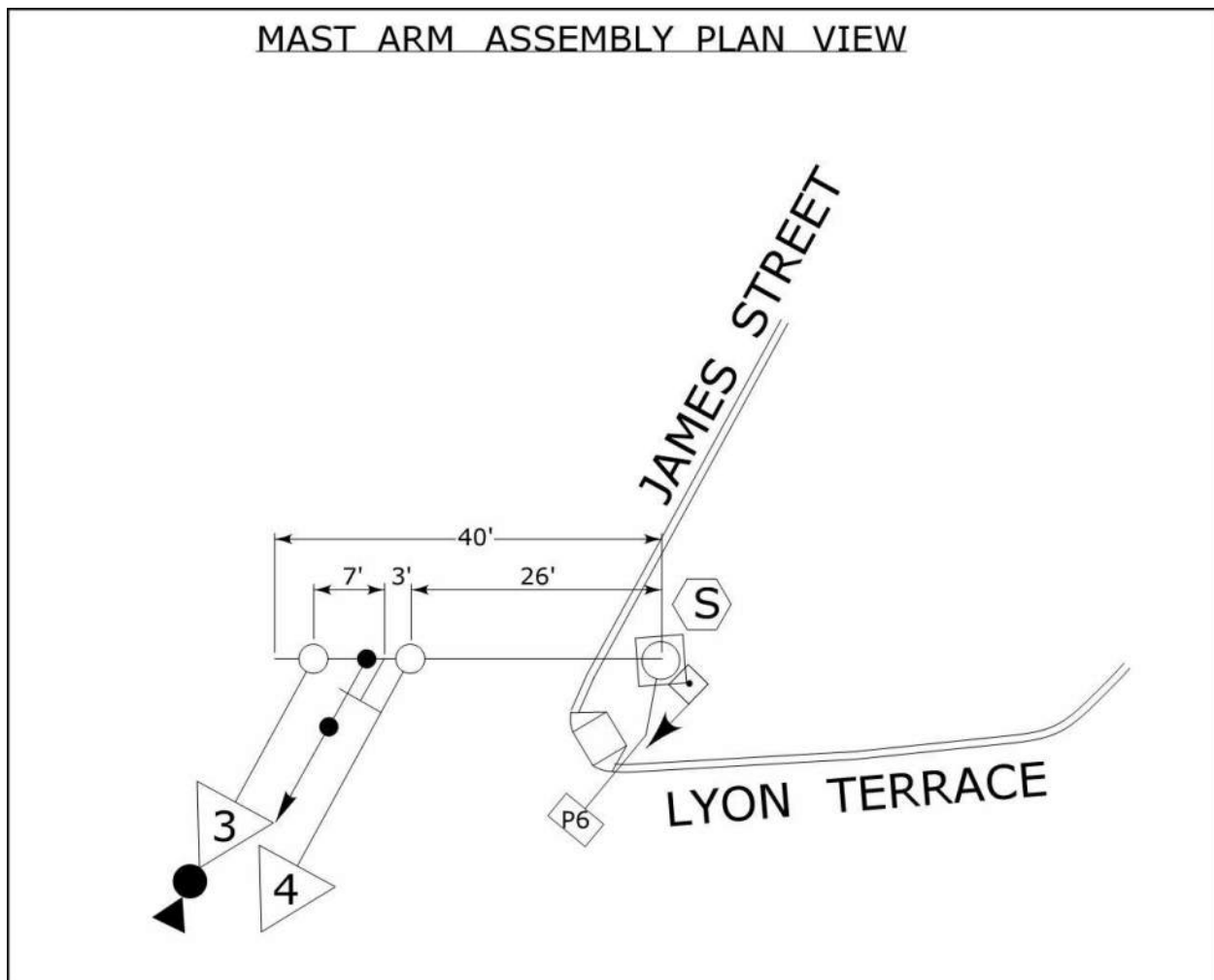

Figure 10-4 Mast Arm Assembly Plan View

11 PEDESTRIAN/BICYCLIST CONSIDERATIONS

The design and operation of a traffic control signal takes into consideration the particular characteristics of the intersection as well as the needs of vehicular, pedestrian, and bicycle traffic. When pedestrians or bicyclists approach a signalized intersection they are legally required to follow the same red, yellow, and green indications that are provided to control the motorist unless there are separate pedestrian or bicycle indications.

There are circumstances where it is reasonable to expect pedestrians to have a need to cross a street. If the basic signal operation does not include satisfactory provisions for pedestrians, they may need access to a pushbutton that would modify the basic signal operation to provide suitable phasing and timing. Chapters 4E and 4F of the MUTCD can be consulted for guidance on pedestrian control features and placement of pedestrian pushbuttons and indications.

Due to the wide variety of field conditions, it is not possible to list all situations where pushbuttons should or should not be provided; however, the majority of situations may be accounted for by considering the pedestrian presence potential and need. Each pedestrian/bicyclist crossing movement should be considered on a case-by-case basis however, in general, most intersections require some type of pedestrian provisions.

There are a limited number of situations where pushbuttons do not need to be provided. These include:

1. Remote areas without indications of a pedestrian/bicyclist presence.
2. The pedestrian crossing would be to an area restricted to pedestrians, such as, expressway ramps.
3. The pedestrian crossing would otherwise be illegal.
4. One of the termini at the crossing lacks a walking area or a reasonable site for a pedestrian presence and is considered potentially hazardous, e.g., physically restricted by guide rail, steep embankment, retaining walls, bridge pier or abutments.

In those instances where pushbuttons are not provided, the Local Traffic Authority should be consulted. The exclusion of pushbuttons itself does not require an action by the Office of State Traffic Administration. However, if no pushbuttons are included in the signal design then "No Pedestrian Crossing" signs should be installed. These signs are a regulatory item, and therefore a traffic investigation report approving their installation is required.

Pushbuttons should be located in an accessible area reasonably removed from traffic. In areas of continuous sidewalks, the pushbuttons shall be accessible from the sidewalk. If attached to a support structure that is not adjacent to the sidewalk, a section of sidewalk should be extended to the pushbutton. The construction of a pedestrian ramp and landing area shall be pursued at all pedestrian crossings (see Highway Standard Sheets for design standards). All pushbuttons installed shall be Americans with Disabilities Act (ADA) compliant. Pushbutton locations should be aligned for future Accessible Pedestrian Signals (APS), parallel to the crossing, where possible.

The choice of locations for pushbuttons may be influenced by signal phasing and/or turning volumes. For example, at an intersection with a double left-turn lane on the side street (without an exclusive pedestrian phase), it is generally preferable to cross pedestrians on the artery leg that is not receiving the double left-turn movement.

The designer should check the placement of guide rail, catch basins, utility poles, etc. that may not be shown on the signal plan and may restrict access to pushbuttons. The designer should also check the cross section plans for embankments and slopes.

Pedestrian Actuated Side Street Green

Pedestrian actuation of side street green for crossing the arterial may require more time than might otherwise be allotted to the side street phase. Pedestrians should normally be provided time to cross from curb line to curb line at a normal walking speed of 3.5 feet per second. In areas where elderly pedestrians, pedestrians with disabilities, or pedestrians who may travel at a slower pace are expected, a walking speed of less than 3.5 feet per second should be considered. The calculated pedestrian crossing time is shown on the signal plan in the WALK and PED CLR rows under the appropriate vehicle phase. Typically one second is entered as the PED CLR time due to controller requirements and the remainder of the required time is entered as the WALK time.

The designer should include an auxiliary signal head to ensure that signal indications are visible to the pedestrian. In addition, at intersections with split side street phasing, signal faces for pedestrians may need to be shielded (tunnel visors/louvers).

Pedestrian signal heads should be conspicuous and recognizable to pedestrians at all distances from the beginning of the controlled crossing to a point 10 feet from the end of the controlled crossing during both day and night.

Pedestrian Actuated Walk/Don't Walk

Pedestrian signal heads are special types of traffic signal indications intended for the exclusive purpose of controlling pedestrian traffic. They may also be of use to bicyclists. These heads consist of a walking person (symbolizing walk) and an upraised hand (symbolizing don't walk). The meanings of pedestrian signal heads are as follows:

1. A steady upraised hand symbol (symbolizing DON'T WALK), means that a pedestrian shall not enter the roadway in the direction of the head.
2. A flashing upraised hand symbol (symbolizing DON'T WALK), means that a pedestrian shall not start to cross the roadway in the direction of the head, but that any pedestrian who has already started to cross during the steady walk symbol shall proceed to the other side of the road, or to an island of sufficient width to allow pedestrians to wait.
3. A steady walking person symbol (symbolizing WALK), means that a pedestrian facing the signal head is permitted to start to cross the roadway in the direction of the head, possibly in conflict with turning vehicles. The pedestrian shall yield the right-of-way to vehicles lawfully within the intersection at the time that the walking person symbol is first shown.

Pedestrian signal heads shall be used in conjunction with a pedestrian phase where all vehicular traffic (except right-turn-on-red) is stopped. This is commonly referred to as an "exclusive" pedestrian phase. Pedestrian calls are remembered by the controller regardless of the phase mode setting. To minimize the potential for unnecessary vehicle calls during the initialization of the controller, the exclusive pedestrian phase mode should be set to non-lock.

Pedestrian signal heads may also be used to control when pedestrians may start to walk with the green indication for vehicles going parallel to the pedestrian crossing. This type of pedestrian control is commonly referred to as a "concurrent" pedestrian phase and is typically limited to city or town owned traffic control signals. Pushbuttons are typically needed to actuate the side street phase to cross the artery; pushbuttons may not be needed to cross the side street.

In normal practice, the walk indication is displayed for a period of time, typically seven (7) seconds, to allow a group of people behind the curb to realize they may start to walk and step into the street, but be watchful of turning vehicles. Following the walk indication is a pedestrian clearance time to provide sufficient time for the pedestrian to walk from the curb line to at least the far side of the traveled way (or to a median of sufficient width for pedestrians to wait) at a normal walking speed of 3.5 feet per second. This calculated pedestrian clearance time should consist of a flashing DON'T WALK interval as well as a buffer interval of 4 seconds during which a steady DON'T WALK is displayed and vehicular traffic is not allowed to move. The buffer interval is typically placed in the yellow change interval of the exclusive pedestrian phase. In areas where elderly pedestrians, pedestrians with disabilities, or pedestrians who may travel at a slower pace are expected, a walking speed of less than 3.5 feet per second should be considered.

Pedestrian signal heads should be conspicuous and recognizable to pedestrians at all distances from the beginning of the controlled crossing to a point 10 feet from the end of the controlled crossing during both day and night.

A pedestrian hybrid beacon is a special type of traffic control device used to warn and control traffic at marked mid-block crosswalks and allow pedestrians to cross the roadway during an exclusive pedestrian phase. See Chapter 4 (Phasing) of this manual for more information on the two types of pedestrian hybrid beacons and their typical operation.

Accessible Pedestrian Signals (APS)

Accessible pedestrian signals shall be installed at all exclusive pedestrian phases. As noted in the MUTCD, under stop and go operation, accessible pedestrian signals shall not be limited in operation by time of day or day of week.

The APS system includes a pushbutton locator tone, a vibrotactile arrow pushbutton, and a percussive tone. The pushbutton locator tone is audible at all times that the traffic signal is in stop and go operation except during the pedestrian walk interval. The locator tone consists of a 0.15 second duration tone repeating at one second intervals. Per the MUTCD, the pushbutton locator tone shall be audible 6 to 12 feet from the pushbutton, or to the building line, whichever is less. During the walk interval, the locator tone is silenced and a percussive tone which repeats at eight to ten ticks per second is audible. Also during the walk interval, the vibrotactile arrow, which is oriented parallel to the crossing, vibrates. A summary of the features associated with the APS system is shown below.

- Percussive tone repeating at 8 to 10 ticks per second during “walk” interval (typically 7 seconds) consisting of multiple frequencies with a dominant component at 880 Hz. The tone shall be audible from the beginning of the associated crosswalk.
- Pushbutton locator tone which is a repeating tone with a duration of 0.15 seconds repeating at 1 second intervals at all times other than the walk interval and during flash operation.
- Vibrotactile arrow on pushbutton with arrow pointing parallel to the associated crosswalk (not necessarily pointing directly to crosswalk ramp). Vibrates only when the “Walk” indication is displayed.
- “Wait” speech message initiated by the actuation of the pushbutton.
- All sounds emitted from pushbutton assembly.
- Percussive tone and pushbutton locator tone shall be intensity responsive to ambient sound.
- Pushbutton locator tone audible 6 to 12 feet from the pushbutton, or to the building line, whichever is less.

When an existing traffic control signal that has audible or accessible features is redesigned, the need to maintain this type of signal equipment should be confirmed with the Connecticut Services for the Blind and the LTA by the Division of Traffic Engineering. It should be noted that the Federal Highway Administration made an official interpretation that speech walk messages are not required at intersections with an exclusive pedestrian phase. The Tech Note “PERCUSSIVE TONE ONLY DURING WALK INTERVAL” should be placed on the signal plan. “ACCESSIBLE PEDESTRIAN SIGNAL” should be placed on the signal plan as shown in **Figure 16-2**.

Countdown Pedestrian Signals

The 2009 MUTCD requires the use of countdown pedestrian signals at locations equipped with pedestrian signal heads where the pedestrian change interval (flashing upraised hand) is more than 7 seconds. For uniformity, the Department will provide countdown pedestrian signals at all state owned and maintained locations equipped with pedestrian signal heads. A countdown pedestrian signal informs pedestrians of the number of seconds remaining in the pedestrian change interval. The countdown timer merely repeats the previous cycle pedestrian clearance time and operates independent of the controller setting. To prevent an incorrect countdown time, shortening the pedestrian change interval is not allowed for non-priority pre-emption or manual operation.

Countdown pedestrian signals should not be used at a signal where a combination of exclusive and concurrent walk phases are overlapped as the pedestrian clearance times may vary, giving inconsistent countdown times. In addition, designers should be aware of the potential consequence of countdown pedestrian signals at traffic control signals which include railroad pre-emption phasing. In this situation, if a railroad pre-emption call occurs during the countdown sequence, the next one or two subsequent pedestrian actuations may result in an inconsistent countdown display time. It should be noted however, that the pedestrian clearance time entered in the controller will not be violated in these subsequent pedestrian actuations.

When a countdown pedestrian signal is provided, the following requirements apply:

- To be consistent with MUTCD requirements, the following technical note should be placed on the signal plan: “COUNTDOWN ONLY DURING FLASHING PEDESTRIAN CHANGE INTERVAL.”
- When used with an exclusive pedestrian phase, the pedestrian change interval can be set approximately 4 seconds less than the normally required pedestrian crossing time (pedestrian clearance time). The yellow change interval for the phase should be set to 4 seconds to provide a buffer between the end of the countdown and the start of the conflicting green.
- As previously stated, a consistent pedestrian clearance is essential for the accuracy of the countdown timer. When the intersection is under manual control, most interval times (including the pedestrian change interval) are determined by the manual operator. The operator cannot ensure the same pedestrian clearance time each time the controller is advanced out of the pedestrian phase. To ensure a consistent display on the pedestrian signal, the following technical note should be placed on the signal plan. "MANUAL AND INTERVAL ADVANCE TO BE DISCONNECTED DURING PHASE (*insert pedestrian phase #*) PEDESTRIAN CHANGE INTERVAL.”
- The note "COUNTDOWN PEDESTRIAN SIGNAL" should be placed on the signal plan as shown in **Figure 16-2**.

Bicyclist Considerations

The design shall be reviewed to consider the needs of bicyclists on designated bicycle routes or as requested by a town’s Local Traffic Authority. See Chapter 7 (Vehicle and Bicycle Detection) of this manual for types of bicycle detectors.

12 SIGNING AND PAVEMENT MARKINGS

The extent of lane use signing and pavement marking should be kept to a minimum while being consistent with State Traffic Commission Regulations, the Manual on Uniform Traffic Control Devices (latest edition) and that required for safe and efficient operation at the specific location. Unusual geometric conditions, signal phasing, specific signing needs and operations peculiar to a specific location may suggest other treatments.

In general, movements that are obvious, consistent with basic motor vehicle law, and consistent with driver expectancy do not require redundant expression.

It is desirable to place signs so that they have the greatest target value for the driver. In areas with sheltered turn lanes, the "turn only" sign should be placed overhead. It is also preferable to place "No Turn On Red" signs overhead. Signs which are generally no larger than 24 in. x 24 in. (0.6 m x 0.6 m) can be span-mounted. Exceptions to this are "LEFT TURN SIGNAL" and "RIGHT TURN SIGNAL" signs which can be 24" x 30" (0.6 m x 0.75 m).

When post-mounted lane-use control signs are used, one should be placed in the vicinity of the stop bar and another should be placed sufficiently in advance of the intersection so that the driver may select the appropriate lane. Supplemental, post-mounted, lane-use signs may be used with overhead lane-use signs.

Pavement marking arrows may be used to supplement the lane-use control signing. They are generally used for specific turn lanes. When used, the first arrow, closest to the intersection, should be placed 40 feet (12 m) from the stop bar. The specific turn arrow marking will suffice. The word "Only" is not used.

For additional information on pavement marking details, refer to the Office of Engineering's Drawing "Special Details & Typical Pavement Markings for Two-way Highways" which is available on the DOT's website.

There are various reflective intensities for signs used at signalized intersections. For specific information regarding legend, size and material type, refer to the DOT's Catalog of Signs - latest edition, which is available from the Division of Traffic Engineering.

See Chapter 21, Preliminary Design Requirements, Item # 10 for details on plan preparation when a signing and pavement marking plan is needed in addition to the signal plan.

13 MERRITT PARKWAY GUIDELINES

Span poles will be selected to be as unobtrusive as possible. Existing utility poles will be used for supports where feasible. Galvanized steel poles will be the standard pole when utility poles are not available. Depending on the setting, the poles shall be painted either charcoal gray or dark green when the normal galvanized finish is not aesthetically appropriate for the area. Typically, charcoal gray is used.

Signing and pavement marking will follow normal state practice.

14 FLASHING MESSAGE SIGNS

There are locations where motorists traveling on the main (artery) roadway may encounter conditions that restrict the visibility to the signal faces, queued vehicles or both. Field measurements can determine whether these visibility inadequacies exist. If the sight restriction to either the signal heads or a queue of vehicles or both is caused by the vertical alignment of the road, a roadway profile may be necessary to assist the designer.

Many countermeasures can be implemented to address these visibility concerns such as the installation of auxiliary signal heads, regrading, vegetative clearing, signal retiming, etc. However, it may be determined that a flashing sign, integrated with the signal operation, is needed. This chapter provides guidance on the design of such a sign if such a countermeasure is determined to be appropriate.

A flashing sign, integrated with the signal operation, may also be appropriate for the following situations.

- Expressway terminus signals.
- Remote signalized locations where motorists would not expect to come upon a traffic control signal.

When these signs are provided at expressway terminus signals or remote signalized locations, the use of the methodology for "Inadequate Visibility to Signal Heads" which follows is suggested.

A static "Signal Ahead" sign should also be provided in advance of all flashing sign installations. In general, the signal indications and flashing sign should not be visible to motorists at the same time.

Inadequate Visibility to a Queue of Stopped Vehicles

Under this situation, a side mounted “Be Prepared to Stop” sign with flashers, and a “When Flashing” subplate is typically used.

Determining the Critical Queue

The critical queue is the longest queue that could accumulate that does not have adequate stopping sight distance for approaching vehicles. It should be noted that the maximum queue is not necessarily the critical queue. It may be difficult initially to establish this value. The potential for this condition to occur is first determined by a field visit to the intersection. A more precise queue length estimation is later calculated through a capacity/queue analysis. It is essential that turning movement counts are obtained for periods when peak queue build ups are likely so the effect of heavy left or right turning movements with or without turn lanes can be properly evaluated. The effect of future traffic growth should also be considered.

Locating the sign

Calculate the stopping sight distance to the critical queue to permit approaching vehicles traveling at the 85th percentile speed to stop prior to reaching the queue. When locating the sign, include a distance reduction of 175 feet for sign visibility. This results in the sign being placed, at a minimum, a distance of (SSD – 175 feet) from the critical queue. Further adjustments to the sign location may be necessary to ensure proper sign visibility.

$$\text{Stopping Sight Distance (SSD)} = 1.47Vt + 1.075 \frac{V^2}{a} \quad (\text{Level alignment})$$

$$\text{Stopping Sight Distance (SSD)} = 1.47Vt + \frac{V^2}{30\left(\frac{a}{32.2} \pm G\right)} \quad (\text{On grade})$$

where: t = brake reaction time, 2.5 seconds

V = 85 percentile speed, mph

a = deceleration rate, 11.2 ft/sec²

G = the percent of grade divided by 100

Refer to **Figure 14-1** for an example of locating the sign.

Determining time when Flashing Operation Occurs

Per the 2003 MUTCD Section 4D-15, page 4D-16, the sign should be timed in such a manner as to flash during the period when road users passing the sign at the speed limit for the roadway might encounter a queue resulting from the display of a red signal upon arrival at the signalized location. The sign should begin flashing at the onset of the artery yellow and remain on while the artery is red and through the portion of artery green time (G_c) needed to process the critical queue which accumulated on the approach. This green time (G_c) can be calculated using the following formula:

$$G_c = 3.7 + 2.1 (N)$$

where N is the number of queued vehicles.

For this application a “dummy” phase which precedes the artery phase is necessary to accommodate the sign operation. The portion of artery green time (G_c) needed to process the queue which accumulated on the approach is entered in the “dummy” phase as shown in the movement diagram in Figure 14-2. Since the “dummy” phase precedes the artery phase, appropriate yellow and red clearance intervals are placed in the artery phase.

The use of a "dummy" phase is the preferred method to accommodate the sign operation however, there are certain phasing conditions that may prevent the use of a dummy phase to obtain " G_c ".

- Advance phase preceding the artery phase in the opposite direction of the sign.
- Dual ring sequence

The necessary time " G_c " may then be taken from the walk interval of the associated artery phase. Under these conditions, the design should be reviewed by the Signal Lab to ensure the timing and sequence is correct and all pertinent technical notes are included.

Signals with certain pre-emption sequences may cause the sign operation to time incorrectly. Therefore, any locations with pre-emption where a flashing sign is proposed or where a revision is proposed at a signal having flashing signs, the designer should have the design reviewed by the Signal Lab prior to approval. **Pre-emption sequences which could cause the sign operation to time incorrectly will not be allowed.**

Inadequate Visibility to Queue of Stopped Vehicles

Restriction is vertical crest; 6% downgrade

Posted Speed 40 mph 85% speed 50 mph

Critical Queue of 9 Vehicles

$$SSD = 1.47 (50) (2.5) + \frac{50^2}{30 ((11.2/32.2) - 0.06)}$$

SSD = 475 feet

$$\text{Sign Location} = 475 - 175 = 300 \text{ Feet}$$

$$G_c = 3.7 + 2.1 (9) = 23 \text{ sec}$$

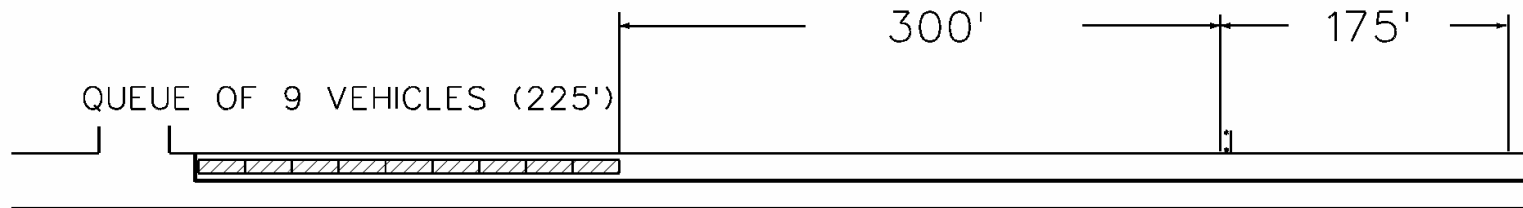

Notes:

- **This example is presented for illustrative purposes only. The calculations shown are applicable to this specific example. Due to the complex nature of traffic flow characteristics, guidelines should be applied with engineering judgment to account for site specific field conditions.**
- **A static “Signal Ahead” sign should also be provided in advance of the flashing sign.**
- **In general, the signal indications and flashing sign should not be visible to motorists at the same time.**

Figure 14-1 Locating the sign (Inadequate Visibility to a Queue)

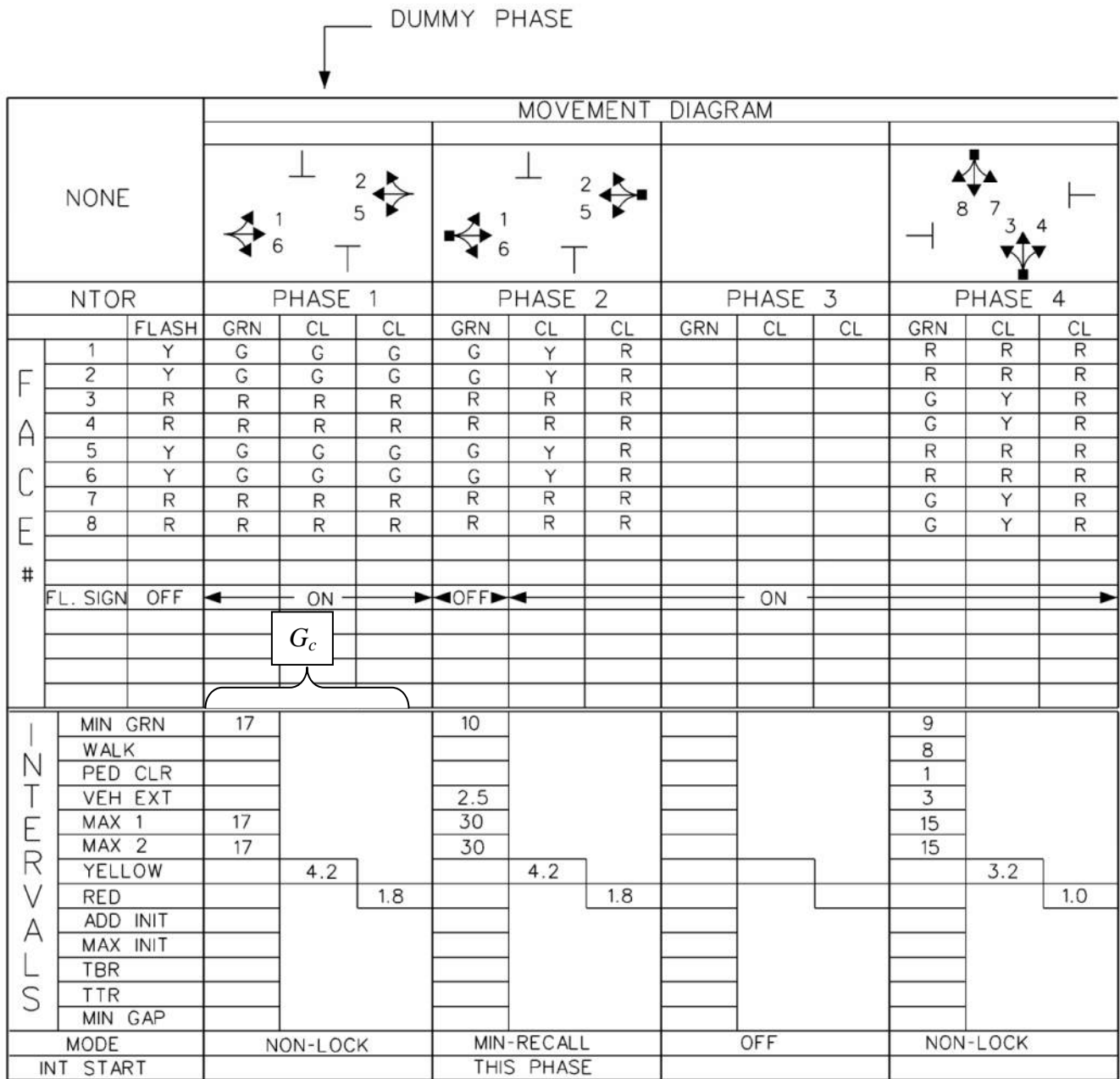

TECHNICAL NOTES

PHASE 1 TO ALWAYS PRECEDE PHASE 2

Figure 14-2 Sequential Phasing with a “Dummy” Phase

Inadequate Visibility to Signal Heads

Under this situation, a side mounted “When Flashing Stop Ahead” sign with flashers or an overhead flashing “Stop Ahead” sign should be considered. A side mounted sign is generally used however there are special situations such as multiple lane approaches to expressway termini where an overhead sign may be necessary.

When motorists will have restricted visibility to both signal faces and queued vehicles (on the same approach), the “When Flashing Stop Ahead” sign with flashers or an overhead flashing “Stop Ahead” sign should be considered. The sign should be located based on the methodology that yields the greatest distance from the stop bar.

Locating the sign

Calculate the stopping sight distance (SSD) needed for a vehicle traveling at the 85th percentile speed to stop at the stop bar. Place the sign, at a minimum, a distance of the calculated SSD from the stop bar. Further adjustments to the sign location may be necessary to ensure proper sign visibility.

$$\text{Stopping Sight Distance (SSD)} = 1.47Vt + 1.075 \frac{V^2}{a} \quad (\text{Level alignment})$$

$$\text{Stopping Sight Distance (SSD)} = 1.47Vt + \frac{V^2}{30\left(\frac{a}{32.2} \pm G\right)} \quad (\text{On grade})$$

where: t = brake reaction time, 2.5 seconds

V = 85 percentile speed, mph

a = deceleration rate, 11.2 ft/sec²

G = the percent of grade divided by 100

Refer to **Figure 14-3** for an example of locating the sign.

Determining time when Flashing Operation Occurs

Per the 2003 MUTCD Section 4D-15, page 4D-16, the sign should be timed in such a manner as to flash during the period when road users passing the sign at the speed limit for the roadway might encounter a red signal upon arrival at the signalized location. The time is that which is needed for a vehicle traveling at the speed limit to go from a point 50 feet in advance of the sign (for motorist recognition) to the stop bar. Refer to **Figure 14-3** for example showing calculation of this time. This calculated clearance time (T_c) is the amount of time prior to the display of the artery yellow indication that the sign should begin flashing. The sign should stay flashing from this point until the artery green indications are displayed again.

- For coordinated or full-actuated signals and signals with any type of quad phasing, a “dummy” phase which follows the artery phase is necessary to accommodate the sign operation. The calculated clearance time (T_c) is entered in the movement diagram as shown in **Figure 14-4**. This time is spread out over a combination of the yellow and red clearance intervals of the artery phase and the green interval of the “dummy” phase. The appropriate artery yellow and red clearance intervals are placed in the “dummy” phase as well as the artery phase to provide for consistent clearances to a pre-emption movement. Because of driver expectancy, once the sign(s) begins to flash the controller must service an opposing phase. The sign(s) should never begin to flash, and then turn off without the approach signals transferring to red.

Figure 14-4 is an example of an intersection with a flashing sign in one direction which is Ø2. The dummy phase must follow the artery if Ø1&5, Ø1&6 or Ø4 is next. It may be skipped only if Ø2&5 is next. Once in Ø3 and the sign is flashing, a temporary artificial call is placed in Ø1. This ensures at least one opposing phase is serviced. If the call in Ø4 is dropped during Ø3 due to right turn on red, Ø4 may be skipped however Ø1 will be serviced, even if there is no vehicle present. If Ø4 is serviced, the temporary artificial call in Ø1 is dropped and Ø1 may be skipped if there is no real demand. It should be noted that Ø1 should have presence detection and be in non-lock mode.

Figure 14-5 is an example of an intersection with a flashing sign in both directions. The dummy phase must always follow the artery. Once in Ø3 a temporary artificial call is placed in Ø1&5. If the side street calls are dropped due to right turn on red, the side street phases may be skipped, however Ø1&5 will be serviced, even if there are no vehicles present. If any side street is serviced, the temporary artificial call in Ø1&5 is dropped and Ø1&5 may be skipped if there is no real demand. It should be noted that Ø1&5 should have presence detection and be in non-lock mode.

- Signals, with an exclusive walk phase, regardless of the operation will require the use of a “dummy” phase to ensure proper sign operation.
- In the case of uncoordinated semi-actuated signals with simple sequential phasing and no exclusive walk phase, the designer may choose to enter the clearance time (T_c) in the “Don’t Walk” interval of the artery phase rather than use a “dummy” phase. This may allow the use of certain pre-emption sequences which could present timing problems to the sign operation if a “dummy phase” was used. If this operation is being considered, the signal lab should be consulted for appropriate technical notes, etc. The use of a “dummy” phase is the preferred method to accommodate the sign operation.

When using a “dummy” phase in an uncoordinated semi-actuated signal with simple sequential phasing and no exclusive walk phase, include technical notes to ensure the dummy phase always follows the artery phase. The appropriate artery yellow and red clearance intervals are placed in the “dummy” phase as well as the artery phase to provide for consistent clearances to a pre-emption movement. See movement diagram in **Figure 14-6** for example of sequential phasing with a “dummy” phase.

Signals with certain pre-emption sequences may cause the sign operation to time incorrectly. Therefore, any locations with pre-emption where a flashing sign is proposed or where a revision is proposed at a signal having flashing signs, the designer should have the design reviewed by the Signal Lab prior to approval. **Pre-emption sequences which could cause the sign operation to time incorrectly will not be allowed.**

The use of dilemma zone detection (as described in Chapter 7) is not effective in designs where “When Flashing Stop Ahead” signs with flashers or overhead flashing “Stop Ahead” signs are used. This is because of the “fixed time” dummy phase which follows the artery phase in a design of this type.

To retain the traffic responsive nature of full-actuated signal operation, it is suggested that artery detection be included in the design. A single loop per lane located approximately 3 seconds of travel time in advance of the stop bar is generally acceptable. The vehicle extension timing will define the maximum “gap” that can occur without exiting the actuated artery phase. The timing should be set as short as practical to avoid servicing stragglers but long enough to serve the demand that is present.

Inadequate Visibility to Signal Heads

**Restriction is vertical crest; 6% downgrade
Posted Speed 40 mph 85% speed 50 mph**

$$SSD = 1.47 (50) (2.5) + \frac{50^2}{30 ((11.2/32.2) - 0.06)}$$

SSD = 475 feet

Sign Location = 475 Feet

$$T_c = \frac{475 + 50}{40(1.47)} = 9 \text{ sec}$$

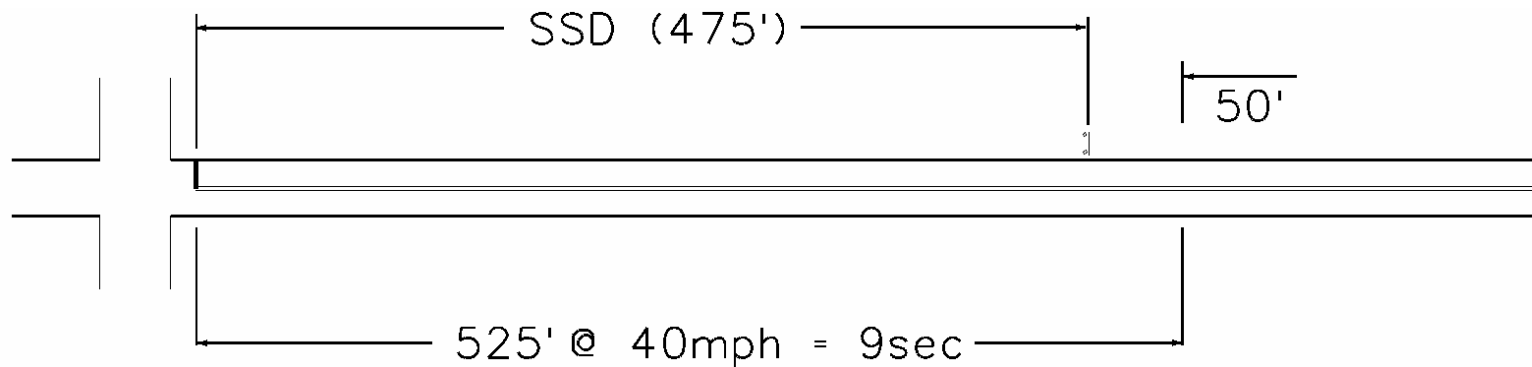

Notes:

- This example is presented for illustrative purposes only. The calculations shown are applicable to this specific example. Due to the complex nature of traffic flow characteristics, guidelines should be applied with engineering judgment to account for site specific field conditions.
- A static “Signal Ahead” sign should also be provided in advance of the flashing sign.
- In general, the signal indications and flashing sign should not be visible to motorists at the same time.

Figure 14-3 Locating the sign (Inadequate Visibility to Signal Heads)

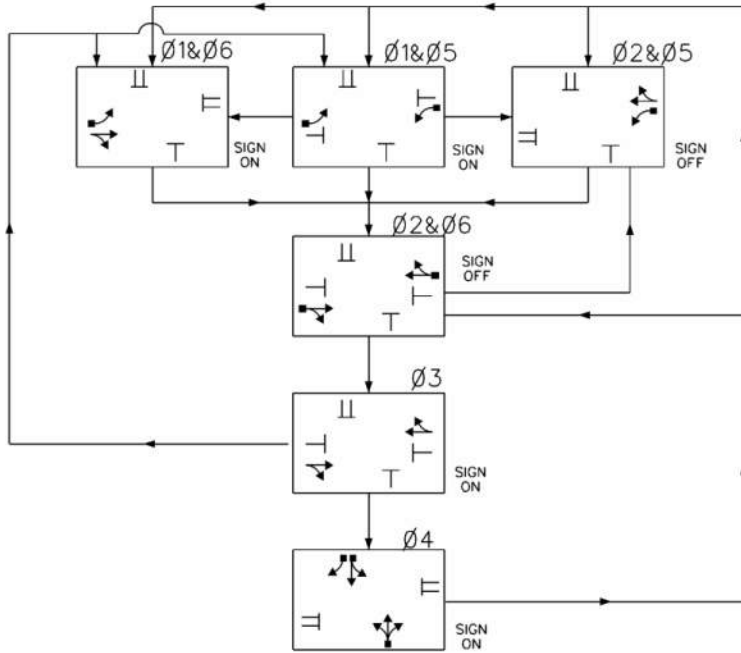
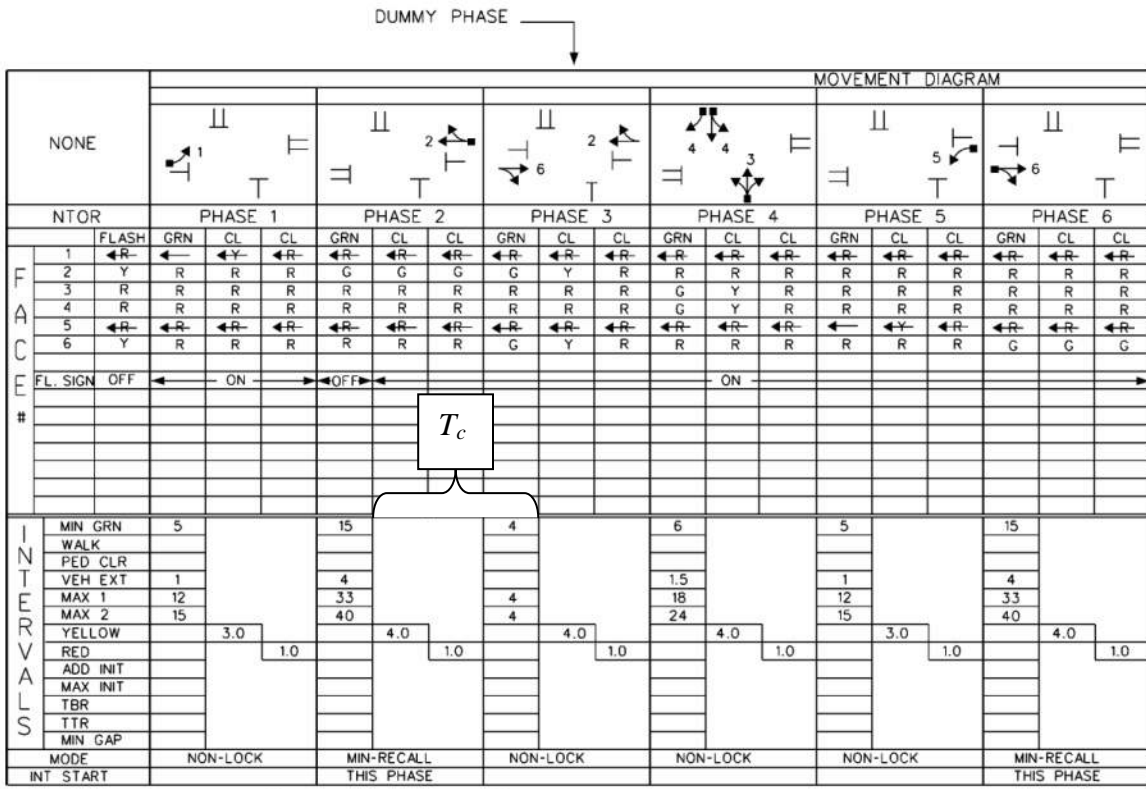

TECHNICAL NOTES

- PHASE 2 & 6 ON TO OMIT PHASE 1 & 4
- PHASE 1 & 4 CHECK TO CALL PHASE 3
- PHASE 3 ON TO CALL PHASE 1

IN THIS EXAMPLE, THE FLASHING SIGN IS ON THE ROADWAY APPROACH ASSOCIATED WITH PHASE 2

Figure 14-4 Quad Phasing with Sign on one Artery Approach

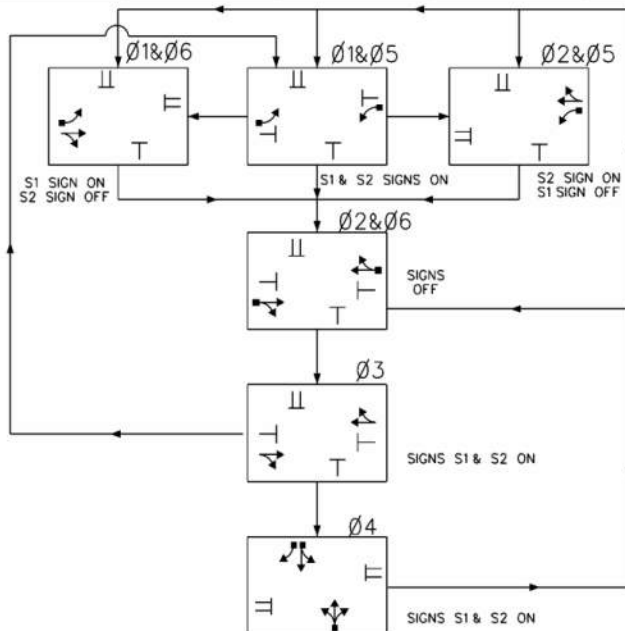
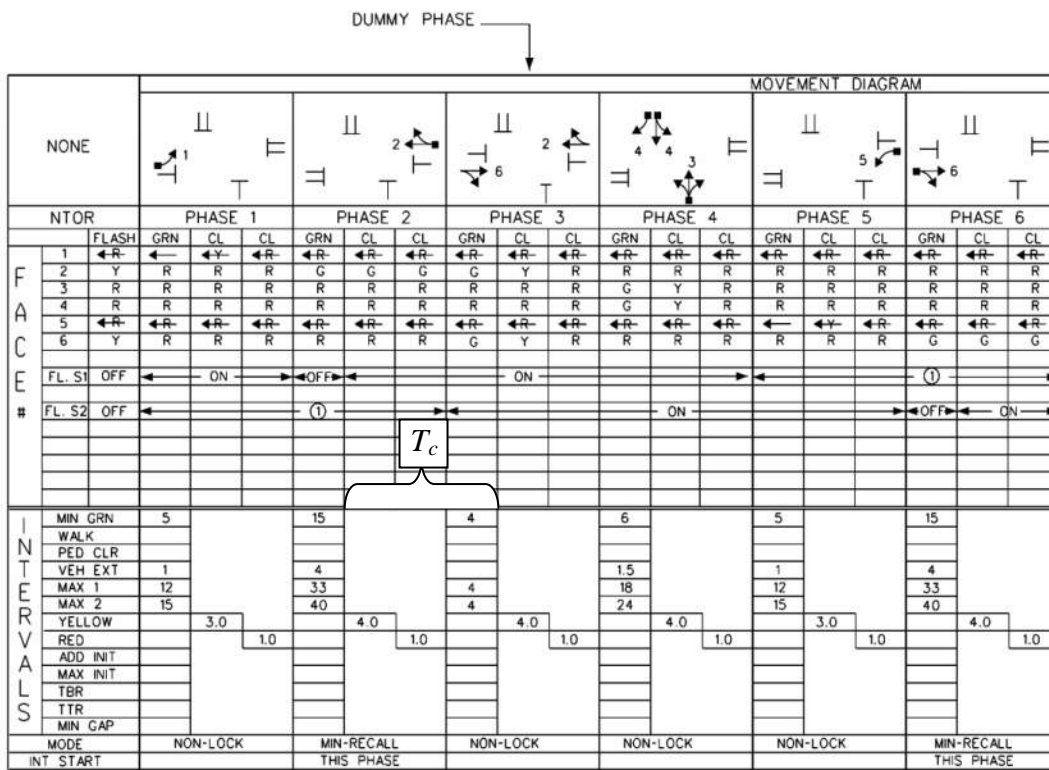

TECHNICAL NOTES

① THE OPERATION OF THIS SIGN DEPENDS ON WHICH PHASE IS IN SERVICE ON THE OPPOSITE RING

PHASE 2 & 6 ON TO OMIT PHASES 1,4 AND 5
 PHASES 1, 4 AND 5 CHECK TO CALL PHASE 3
 PHASE 3 ON TO CALL PHASE 1 & 5

IN THIS EXAMPLE, THE FLASHING SIGN S1 IS ON THE ROADWAY APPROACH ASSOCIATED WITH PHASE 2 AND THE FLASHING SIGN S2 IS ON THE ROADWAY APPROACH ASSOCIATED WITH PHASE 6

Figure 14-5 Quad Phasing with Signs on both Artery Approaches

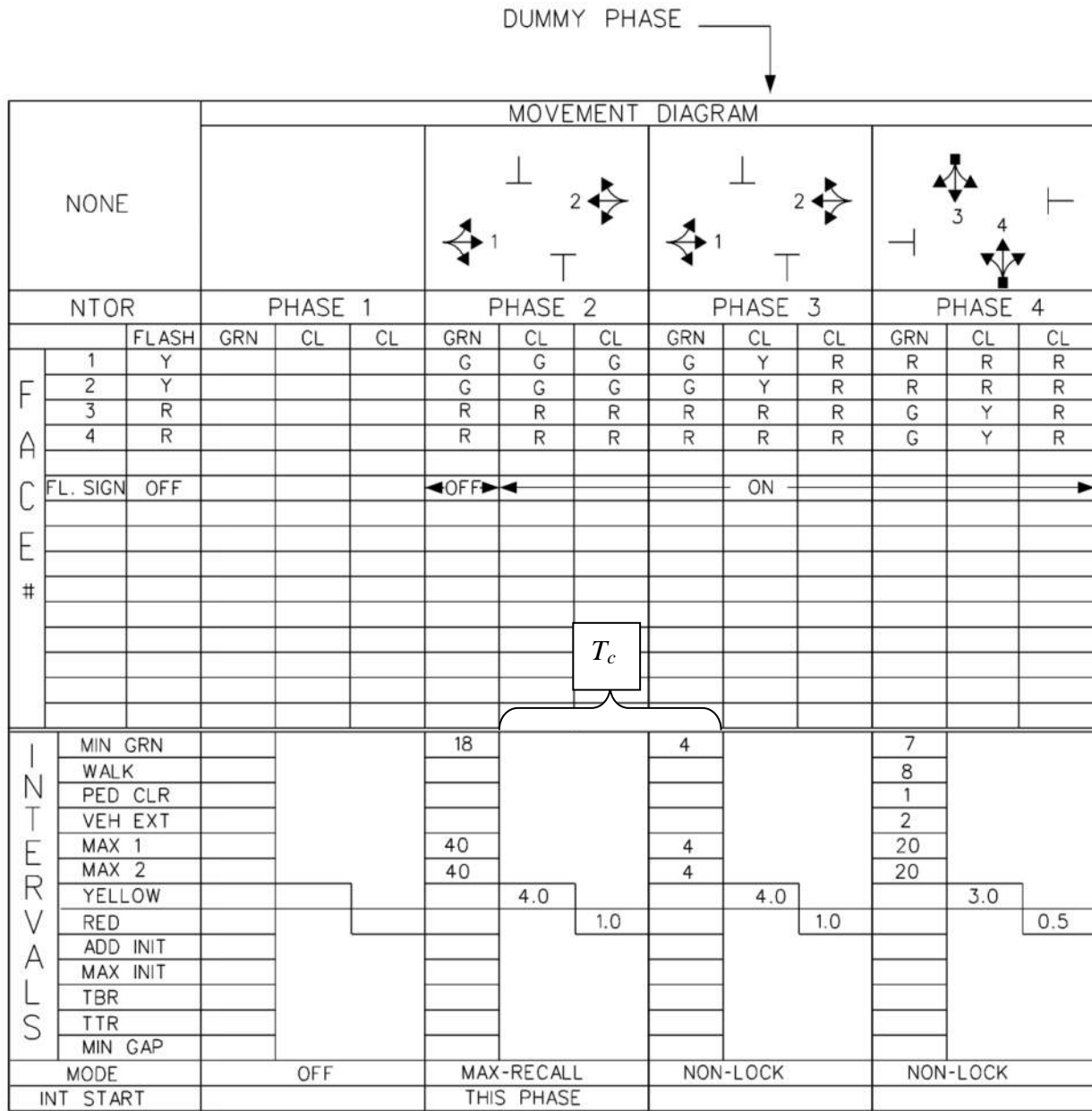

TECHNICAL NOTES

- PHASE 2 ON TO OMIT PHASE 4
- PHASE 4 CHECK TO CALL PHASE 3
- PHASE 3 ON TO CALL PHASE 4

Figure 14-6 Sequential Phasing with a “Dummy” Phase

15 ELECTRICAL CONSIDERATIONS

General

A traffic signal is a device consisting of various specialized electrical and electronic appurtenances that function together to provide the operation as shown on the traffic signal plan. Low voltage or ground-true input circuits such as vehicle and pedestrian detectors, pre-emption detectors, and interconnect communication provide information to the timer, which is defined by the National Electrical Manufacturers Association (NEMA) as the Controller Unit (CU). Output circuits such as red, yellow, green, walk, don't walk, flash-power and a feed to a flashing sign, all of 120 VAC potential, are activated depending on the CU program and the information received from the input circuits. The controller cabinet, which is defined by NEMA as the Controller Assembly (CA), is powered by 120 VAC. Occasionally it will also have a telephone service. A traffic signal is installed by a licensed electrical contractor and maintained by electricians and electronic technicians. The designer must consider the electrical engineering requirements of a traffic signal in order to comply with the governing codes and regulations, and the installation standards of the various utility companies serving the State. The following subsections address the electrical concerns that are common in a traffic signal design and installation.

Governing Codes, Regulations, and Standards

All electrical designs must be in accordance with the "National Electrical Safety Code" (NESC), "National Electrical Code" (NEC), CT Department of Public Utility Control (DPUC), various State Statutes, and local utility company regulations. These design and construction standards have been developed to ensure a safe work site for the installation crew and a safe installation for maintenance personnel, traffic engineers, and the public.

The "National Electrical Safety Code" (NESC) establishes clearances between utility lines to all signal appurtenances such as span wire, steel poles and mast arm support structures. Refer to the following sections of the NESC:

- 233 Clearances Between Wires, Conductors, and Cables Carried on Different Supporting Structures
- 234 Clearances of Wires, Conductors and Equipment from Buildings, Bridges, Rail Cars, Swimming Pools, and Other Installations
- 238 Vertical Clearance Between Certain Communications and Supply Facilities Located on the Same Structure.

In addition to the NESC clearances in Section 234, all traffic signal appurtenances such as span poles shall be at least 10 feet (3 m) from utility primary cables.

The NEC or Code is published and maintained by the National Fire Protection Association (NFPA). The Code was originally developed by a committee in the late 1800's. Commercial and residential electrification was becoming common and along with that, accidents and electrical fires. The Code consolidated the five electrical codes that were in use at that time. It has been adopted to provide a design and construction standard in all 50 states as well as several other countries. It contains a vast amount of information concerning electrical installations. There also is an extensive list of electrical terms and definitions. It is highly recommended the traffic signal designer have on hand a current copy of the NEC and the Handbook which further explains the regulations. The designer must be familiar with the pertinent section of the Code when preparing a signal design.

The DPUC regulations Section 16-243-1 through 243-12, "Construction and Maintenance Standards Governing Traffic Signals Attached to Public Service Company Poles", cover several topics regarding the use of a utility pole in a traffic signal design. See the Statutes and Regulations on the DPUC web site. Also, there are standard utility pole construction illustrations at the end of these regulations.

Other Controlling Conditions

Ownership and Maintenance

Traffic signals may be owned either by the State or the municipality. The ownership of the traffic signal affects certain design and subsequent construction methods. Ownership is based on several factors and is discussed in the Signal Ownership and Maintenance section of this manual. Several municipalities own and maintain a majority of the signals in town, even those on State roads. Many municipalities have design and construction standards that are different from the CT DOT and require special provisions to the "CT DOT Standard Specifications for Roads, Bridges, and Incidental Construction" (Form 816) and also special typical installation sheets. Proprietary equipment may also be necessary. For example; the city of Stamford requires disconnect hangers on all signal assemblies; the city of New Haven uses the type 2070 controller, fiber optic interconnect and video detection; the City of Bridgeport uses polycarbonate signal housings. The electrical design guidelines discussed herein are for State owned traffic signals. Other design practices for municipalities that are different from the Department's may be discussed in the respective section. The designer should consult with the municipality early and often to ensure the plans, specifications, and estimate (PS & E) are consistent with municipal standards.

Funding

The installation cost of a warranted signal is discussed in the Signal Ownership and Maintenance section of this manual. The funding source also affects the design procedure of a traffic signal. When a signal, or revision to a signal, is completely financed by a developer, with no federal, state or municipal money, several design requirements do not apply. There is no federal oversight of the funds. The contract is entirely between the developer and the contractor. The developer hires a CE to prepare the signal design which must be approved by the owner (state or municipality). The CE is not compelled to prepare a PS&E package for the contractor as required in a federal, state or municipal funded installation. For example; a detailed estimate is not needed; current special provisions to the Form 816 are not required; proprietary material (not owned by the DOT) may be specified (without justification) if desired by a municipality. Also the developer is not required to hire a low-bid or a DBE contractor. As a representative of the developer, the designer must be aware that even though current specifications and typical installation plans are not required for an acceptable design, the developer will be responsible for an installation that meets current DOT or municipal standards. It is highly recommended that the designer provide a complete, approved PS&E package to the contractor to ensure the installation will be accepted as designed.

Pre-design Site Inspection

If a survey plan of the intersection is available it will show the ROW lines, as well as all gas gates, watergates, hydrants, manholes, catch basins, utility poles, various other objects and structures, and even overhead electric cables. It may also show underground conduits, RCP, and sanitary sewer lines. The survey plan, although very informative and helpful, should not be used alone to complete the signal design. The designer should conduct a site inspection to visually check the intersection for conditions that will affect the electrical design. It is recommended that the designer create a photographic record of the site which includes all areas of the proposed construction and all affected utility poles. This takes very little time and may be very beneficial later during construction. The location of existing utility facilities, overhead and underground, is the most important thing to check during the site inspection and is discussed in the utility section. Other areas to check include but are not limited to the following:

- Check the terrain for possible complications where traffic signal appurtenances are proposed, e.g., a rock ledge near the intersection suggests bedrock near the surface which may prevent or encumber the installation of conduit or foundations; an adjacent swamp or wetland area may prevent the installation of a pole anchor.
- Determine if there are any trees that need to be trimmed or removed, e.g., saplings or shrubs that have grown adjacent to the utility cables will have to be removed prior to the installation of interconnect cable.
- Check the roadway condition. Detector sawcut must be placed in sound pavement for a reasonable life expectancy. If an approach has damaged or patched pavement where loops are intended the designer should have it milled and resurfaced.

- Check property lines. Sufficient right-of-way is needed for pole anchors. Span wire or messenger with cable should not be placed over private property. This is called an aerial trespass.
- Note any objects which may not be on the survey plans and will affect the signal installation, e.g., trees, bushes, signs, walls, fences, beam rail, etc.
- Check the drainage system. If catch basins are present at the intersection there is a drainage system that must be avoided. The catch basins will be connected by reinforced concrete pipe (RCP). If not shown on a survey plan, the location of the RCP may be learned by looking into the catch basin. The RCP is deep enough so that the placement of conduit will not be affected, but foundations should not be placed over it. Foundations should not be placed adjacent to the catch basin structure either.
- Check the sewer system. The sewer system is usually owned by the municipality but may be owned by a utility company or private entity. Some sewer pipes are pressurized to force the waste uphill. The pipes are generally deep. Manhole structures are placed at regular intervals in the system for maintenance access. If two or more manholes, owned by the same company, are found it can generally be assumed the sewer runs between them. Foundations should never be placed over a sewer line. The sewer system owner should be contacted to either access their plans or to have an employee field locate the main sewer lines and laterals.
- If station numbers are not being used to locate the various traffic signal appurtenances, ensure they are tied off nearby existing physical objects such as a utility pole, catch basin, hydrant, edge of road or extended curb line.
- Check overhead utility facilities (see later guidelines, DPUC regulations, and NESC clearances in the utility section). Identify all existing utility cables that are attached to poles at or near the intersection. Measure and record the heights where attached to the poles and at mid span points where conflicts may be created with a traffic signal span wire or mast arm. Potential conflicts must be discussed and resolved later during the utility meeting.

Handholes and Cast Iron Junction Boxes

The NEC section 347-11 does not allow “more than four quarter bends (360 degrees total) between pull points...” in a conduit run. More than four greatly hinders the installation of cable. A cable pull point may be a handhole, cast iron junction box (CIJB) or a conduit body depending on the RMC installation method. The designer should consider all bends including up-sweeps into foundations and transitions from underground to surface conduit.

Handholes

The Department uses reinforced concrete handholes exclusively whenever a pull point is needed in an underground conduit system. Polymer/concrete, fiberglass or plastic handholes have proven to be not as strong or durable as reinforced concrete and are not used. Handhole placement is not as critical as foundations. They generally don't need station numbers or ties on the plan. The contractor may field locate the handhole as needed to avoid utilities, driveways, or other objects. They may be placed in grass, sidewalk, or raised island areas but never in pavement within the travel way or shoulder area where vehicles and snow plows may damage them. Try to avoid a low area where rain water will drain and collect. If located on a slope, a bank adaptor should be used to keep the top flush with the surrounding earth. The standard cover is diamond plate galvanized steel with an AASHTO H20 (16,000 lbs., 9075 kg/wheel) vehicle load rating. Cast iron covers are available for certain conditions, e.g., in all sidewalk areas; as a municipal standard; or in an area with high vandalism. The cast iron cover is much heavier and is attached with recessed hex bolts. It is a separate item and each handhole where it is intended must be identified on the plan. There are two sizes of handholes that the Department uses. The smallest is 14 inches (355 mm) by 30 inches (760 mm), called Type 2, and is adequate for most pull points. If three or more conduits are terminated the designer should use the larger handhole which is 30 inches (760 mm) by 30 inches (760 mm). Try not to terminate more than six conduits in a handhole to facilitate future wiring changes.

Try not to use a pole or pedestal foundation as an intermediate cable pull point in a conduit run for the following reasons:

- Steel pole and mast arm bases have small handholes which make it difficult to pull cable.
- If a pedestal is knocked down by a vehicle, all conduit and cable in the base will likely be damaged and/or exposed.

Long straight runs of RMC for dilemma zone detection or interconnect should have handholes for cable pull points. The handholes should be equally spaced a recommended distance of not less than 90 feet (27 m) or more than 180 feet (55 m) apart.

Cast Iron Junction Boxes

A cast iron junction box (CIJB) is commonly used as a pull point for RMC in structure or surface mounted on a bridge structure. The NEC Section 370-28 requires a certain size junction box depending on the size and direction of the conduit that is terminated. Straight pulls require a junction box length not less than eight times the diameter of the largest conduit. Angle or U pulls require a junction box dimension, from the conduit entrance to the farthest wall, six times the diameter of the largest conduit. A conduit body may also be used as a pull point for surface mounted RMC. There are several types known as a "C" or "L" fittings. It is smaller than a junction box; therefore if there are two or more cables in the RMC, the designer should use a CIJB. Junction boxes are estimated and paid as a separate item, not included in the cost of RMC like conduit bodies.

Electrical Conduits

The designer should review and be familiar with the NESC section 32, “Underground Conduit Systems” and several Articles of the NEC, Chapter 3, “Wiring Methods”.

Types

There are many types of electrical conduits available. Except loop detector sawcut wires, all underground cable that is used in a traffic signal installation is installed in rigid metal conduit (RMC). Direct buried cable is not allowed. Although acceptable by the NEC, rigid nonmetallic tubing or conduit such as polyvinyl chloride conduit (PVC) is also not used in a traffic signal installation by the Department. Intermediate metal conduit (IMC) and electrical metal tubing (EMT) is not used either underground or surface mounted. Occasionally there is a need for a short section of flexible raceway. Liquidtight Flexible Metal Conduit (LFMC) is used for this.

Fill

Chapter 9, Table 1 of the NEC restricts the fill of RMC, that contains more than two conductors, to 40% of the inside area. The NEC Chapter 9, Table 4, or the following table, **Figure 15-1**, may be used in determining conduit size. The most common size used in a signal installation is 2 inch (50 mm). The designer should total the cross sectional area of all cables intended for the conduit. For cable diameter and cross section area see **Figure 15-2**. In a new installation the conduit can be sized for the cables it will contain. Try not to use an odd size conduit. For example, if it is determined that a short section of 2 ½ inch (65 mm) conduit is needed for ≤ 40% fill, consider using two of a more common size such as 2 inch (50 mm). For a revision, it is very important that the designer verify that additional cable intended for an existing conduit will not exceed the usable area.

COMMONLY USED CONDUIT					
TRADE SIZE - R.M.C.		TOTAL AREA – 100%		USEABLE AREA - 40%	
in	mm	in ²	mm ²	in ²	mm ²
1	25	0.88	567	0.35	225
1.5	40	2.07	1335	0.83	535
2	50	3.41	2200	1.36	877
2.5	65	4.86	3135	1.94	1250
3	75	7.41	4780	3.00	1935
3.5	90	10.01	6458	4.00	2580
4	100	12.88	8309	5.15	3322

Figure 15-1 Commonly Used Conduit

Installation Methods

There are several conduit installation methods common in a traffic signal design. Conduit can be surface mounted, placed in trench, under roadway, in a structure, under slope protection, or under railroad tracks. The design of the conduit system should facilitate the simplest and most direct wiring between foundations, utility poles and other appurtenances. Following are brief guidelines.

Surface

All RMC placed on a structure or on a utility pole is considered surface mounted. Conduit attached to a utility pole is commonly referred to as a “riser”. The number of traffic signal risers on a pole is limited to two, per the DPUC. Stand-off brackets should be used when: the riser size is greater than 2 ¼ inch (57 mm); the total number of risers on the pole exceeds 2; or there are stand-off brackets already in use on the pole. The pole custodian must be consulted regarding the use of stand-off brackets. A cable pull point is not needed in RMC on a pole. When necessary, RMC may be attached to an existing bridge structure. When crossing a bridge expansion joint a conduit expansion fitting is needed. Expansion fittings are included in the cost of the RMC. Use either a CIJB or a conduit body as a cable pull point. All stand-off brackets, expansion fittings, including the type, and all junction boxes should be identified on the plan.

In Trench

The NESC does not specify the depth of RMC in trench and under roadway. The NEC allows a minimum six inch (150 mm) depth. The Department however, requires a minimum 24 inch (600 mm) depth for all RMC in trench and under roadway. When bedrock is near the surface the designer should include the item “Rock in Trench Excavation 0 - 4 Feet Deep” (0 m - 1.2 m) to ensure the proper depth. Use a concrete handhole as a cable pull point.

Under Roadway

When a road crossing is necessary, try to cross perpendicular to the road. It is recommended to terminate the RMC in a handhole on either side of the road rather than in a foundation. Install a spare conduit for future use. Do not place a trench through an area where loops will be cut. If the trench is not patched properly the pavement will fail destroying the loops. When crossing roads constructed with reinforced concrete, the designer should include the item “Rock in Trench Excavation 0 - 4 Feet Deep” (0 m - 1.2 m) to pay for the extra work involved.

In Structure

Occasionally when a bridge is constructed it is necessary to include RMC in the parapet for interconnect or detector cable. Terminate the conduit in a handhole on either side of the structure. As with surface conduit on a structure, expansion fittings are needed when crossing an expansion joint. Use a CIJB as a cable pull point. The CIJB is paid as a separate item, not included in the cost of the RMC. All RMC, CIJBs, expansion fittings including the type, and handholes must be clearly shown on the bridge plans as well as the signal plan.

Under Railroad Tracks

When it is necessary to install RMC under railroad tracks use a minimum size of 2 ½ inch (65 mm) and terminate it in a large handhole, one on each side of the railroad right-of-way. It is recommended to also include a spare conduit under the tracks. The NESC rule 320A5 requires a minimum 50 inches (1270 mm) depth. The depth may either be increased when required by the RR owner or decreased where that depth is impractical. If reduced, the agreement of both parties is necessary.

Vehicle Detectors

Inductive Loop Detector (ILD)

Theory of Operation

The ILD system essentially consists of a coil of wire (loop) imbedded in the road, a lead-in cable (14/2) from the loop to the CA, and a loop detector amplifier. The ILD was developed and first used in the early 1960's. The hardware and installation methods are continuously being improved but the operating principle is essentially the same. The amplifier transmits a low voltage AC signal to the loop at a certain frequency. The amplifier has an input capacitance (C) which establishes a resonant circuit using the loop inductance (L). When ferrous material passes over the loop, the inductance changes, de-tuning the resonant circuit which the amplifier detects as a vehicle. There have been many publications on ILD theory, practice, and installation and there have been many evaluations on ILD installation methods. The designer should be familiar with ILD characteristics such as the quality (Q) and sensitivity (S) and also the factors that affect them.

Splicing and Number of Turns

An ILD amplifier will operate more consistently and be more reliable when the loop circuit it is connected to has the correct inductance. The loop circuit consists of the loop detectors which are sawcut into the road and the lead-in cable. The loops circuit should be designed to provide an inductance of more than 70 microhenrys (μh). Optimum inductance is over 200 μh . The loop inductance also needs to be greater than the inductance of the lead-in cable from the handhole to the controller. The designer should calculate the inductance of the loops and the inductance of the lead-in cable. See the following loop and lead-in inductance formulas. If the loop inductance is less than the lead-in inductance, increase the number of turns. It should be noted that increasing the number of turns does not increase the Q or the S of a loop, only the inductance. A segmented loop detection zone is commonly used for presence detection. Each segment is cut to a handhole and spliced to the lead-in cable. When the segments are connected in series the inductance is additive. When the segments are connected in parallel the inductance is reduced. See the following inductance formulas. To insure the total inductance of a segmented loop arrangement is high enough, they should be spliced in series not parallel. A construction note is used to ensure the segments are spliced properly.

<u>Loop Inductance (English)</u>	<u>Loop Inductance (Metric)</u>
$L_{loop} = (P/4) (N^2+N)$	$L_{loop} = (3.28P/4) (N^2+N)$
<u>Lead-In Inductance (English)</u>	<u>Lead-In Inductance (Metric)</u>
$L_{14/2} = (0.24 \mu\text{h/ft}) (D)$	$L_{14/2} = (0.78 \mu\text{h/m}) (D)$

Where:

L_{loop} = Inductance of individual loop segment in microhenrys (μh).

$L_{14/2}$ = Inductance of lead-in cable.

P = Perimeter of individual loop segment, in feet or meters.

N = Number of turns.

D = Length of lead-in cable from splice in handhole to controller, in feet or meters.

$L_T = L_1 + L_2 + L_3$ etc. (Total Inductance of Segmented Loops Spliced in Series)

$L_T = 1 \div [(1 \div L_1) + (1 \div L_2) + (1 \div L_3) + \text{(etc.)}]$ (Total Inductance of Segmented Loops Spliced in Parallel)

Where:

L_T = Total inductance of the segmented arrangement.

L_1, L_2, L_3 = Inductance of individual loop segments.

Sawcut

The ILD wire is sealed in the sawcut with a flexible, durable compound. The wire is manufactured specifically for this application in conformance with the International Municipal Signal Association (IMSA) specification 51-7. It has cross-linked polyethylene (XPE) insulation incased in a flexible polyethylene (PE) or polyvinyl chloride (PVC) jacket. The sawcut is exposed to extreme weather conditions, constant traffic, snow plows, and all kinds of vehicular fluids. It is the weakest link in the ILD system. When a loop is installed or replaced, one or more lanes of traffic must be closed. The designer should therefore keep the sawcut from the loop to the curb (known as the home run), as short as possible. Do not cut across opposing lanes of traffic unless it is absolutely necessary. Avoid sawcut on a bridge deck. There may be a waterproof membrane beneath the pavement that must not be damaged. Consider a non-intrusive detection system if a detection zone is necessary on a bridge deck.

Lead-In Cable

The lead-in cable (IMSA specification 50-2) is a shielded, twisted pair cable designed to eliminate induced voltage and electrical interference. It is shown on the plan as 14/2. All electrical

connections in the ILD circuit must be sound. There should be no induced voltage, nor high resistance shorts to ground in the lead-in cable. To minimize the possibility of electrical interference or a bad connection, all ILD lead-in cables are direct wired from the sawcut wires back to the CA. Splices are not allowed, other than connecting to the sawcut wires, and those are soldered. The 14/2 lead-in cables also do not enter the cable closure.

Video Image Detector System (VIDS)

As previously discussed in the Detection section, camera placement is crucial for the operation of a VIDS. The camera should be as high and as directly in front of the approach as possible. If the support structure (span pole or mast arm) is not in the optimal location or is not high enough, a bracket may be used to mount the camera. The designer must specify the length of the bracket. It is usually paid for as a separate item.

Each camera requires a power feed and a coaxial cable for the video return. A special siamese type cable, RG-59/U, is used which consists of a twisted pair of conductors and a coaxial conductor within one jacket. This is shown on the plan as “camera cable”.

Microwave Detector

Microwave detectors are also discussed in the Detection section. Essentially the RF system is self contained, with the transmitter, receiver, and output circuit in one unit. An amplifier in the CA is not needed. The detector requires 4 conductors, two for power, and two to provide an output to the CU. A shielded cable is not required. A 14/5 cable may be used although a four conductor (2 pair), 18 AWG, stranded, unshielded, PE insulation/jacket cable is recommended. It is shown on the plan as 18/2 pair.

Others

There are other types of detection systems available to the designer that are not commonly used by the Department in a traffic signal design. Some are more suitable for speed, volume, & classification data collection in an ITS rather than for intersection control. There are no specifications and typical installation drawings on the Department’s website. If requested by a municipality, the designer should thoroughly research the system and provide all the necessary electrical PS&E. Following are brief descriptions and guidelines for several alternate detection systems.

The ultrasonic detector is similar to the microwave in that the transmitter, receiver and output circuit are self contained in one unit. An amplifier is not needed. A 4 conductor cable is required for a power feed and the detection return. The difference is it operates at a lower frequency, ≈ 50 kHz. It will detect stationary vehicles providing presence detection. The disadvantages are it must be mounted either vertically (directly over the detection zone) or horizontally (side-fire) perpendicular to the vehicle path (3 feet to 5 feet (1.0 m to 1.5 m) high). It also has a limited range (22 feet (6.7 m)) and area of detection (5 feet (1.5 m) diameter).

Infrared detection systems sense the thermal energy in the far-infrared range (100+ GHz) of the electromagnetic spectrum. There are two types, active and passive infrared detectors. The active type transmits an energy beam to the detection zone and measures the reflected energy. It cannot provide presence detection. The passive type detects the thermal energy of a vehicle as compared to the surrounding road surface. It can provide presence detection. The location of the detector is critical for the proper operation. Because of their characteristics and location restrictions, the infrared detectors are more suitable for vehicle data collection in an ITS rather than intersection control.

Magnetic detectors (some known as magnetometers) are available in two types; the single-axis and the dual-axis sensor. They tune to the earth's magnetic field and when the magnetic field is disrupted by the ferrous material in a vehicle, an output call is produced. The single-axis type will only detect vehicles moving more than ≈ 4 mph (6.4 kph) therefore will not provide presence detection. The dual-axis type will provide presence detection. The dual-axis sensor has a relatively small direction area. Several are needed to provide a large presence detection zone. The detector sensor(s) are pre-wired by the manufacturer with a short length of cable which is spliced to a 14/2 detector lead-in cable. A magnetic detector amplifier is also required in the CA.

A self powered vehicle detector (SPVD) is a dual-axis type of magnetometer that does not require a physical connection to the CA. It is battery operated and sends the vehicle call back to the CA over RF. An antenna is required at the intersection, and a receiver/amplifier is required at the CA.

An acoustic detector senses the high frequency noise produced by moving vehicles tires. It cannot provide presence detection. The sensor is side mounted, 25 to 40 feet (7.6 m to 12.2 m) high and is capable of monitoring up to 5 lanes. The primary application is speed, volume & classification data on an expressway. It has little or no application for intersection control detection.

Traffic Signal and Pedestrian Wiring

The Department has standardized the type of cables used in a traffic signal installation. These are shown in **Figure 15-2** as well as the common use and the size (diameter and cross section area). Cable used to feed traffic and pedestrian signals has solid conductors (not stranded), straight-lay, rated at 600 volt (IMSA spec 19-1 or 20-1). It is identified on the plan by the American Wire Gauge (AWG) of the conductors and by the number of conductors. For example, a five conductor cable with each conductor #14 AWG is shown as 14/5. Most 120 VAC output circuits are wired with #14 AWG conductors. The designer should use a cable with enough conductors to ensure at least one spare at each signal assembly. List cables on the plan per size in descending order, e.g., 14/21, 14/15, 14/12.

Span wire signals are generally not direct wired back to the CA. A cable closure is mounted on the span wire and connected to the CA with a 21 or 25 conductor cable. Each span mounted signal assembly is then wired to the cable closure by a separate cable. Splices outside the cable closure are not allowed.

Mast arm mounted signals should be direct wired back to the CA. Splices are not allowed in the arm. A splice in the mast arm base it is not recommended.

The cable for pedestrian signals and pushbuttons and also the cable for vehicle detectors are direct wired to the CA. The conductors do not enter the cable closure. This reduces the possible accidental contact with a 120 VAC output circuit which will damage the CU. At least one 14/7 cable is used for each pedestrian signal assembly. A two-way walk signal assembly may have two separate pedestrian movements and then will require two cables.

Audible pedestrian signals are attached to an overhead signal assembly preferably near the center of the intersection. The audible pedestrian signal needs only two conductors and may use spare conductors in the cable that feeds the traffic signal assembly. This is common when an audible pedestrian signal is added to an existing installation. In new construction the designer should use a dedicated 14/3 cable, keeping the conductors separate from the signal cable.

Even when driven by the same phase, traffic signal heads on opposing legs of the artery should be wired separately, not in parallel. This will simplify a future revision such as the addition of an advance overlap or a sequence change from single ring to dual ring.

<u>TRAFFIC SIGNAL CABLES</u>					
<u>TYPE AND/OR SIZE</u>	<u>DIAMETER</u>		<u>AREA</u>		<u>COMMON USE</u>
	<u>in</u>	<u>mm</u>	<u>in²</u>	<u>mm²</u>	
20/3	.35	9	.09	60	Optical Pre-emption Detector
Camera Cable	.25	6	.05	32	VIDS
14/2	.35	9	.09	60	Loop Detector Lead-in, Sonic Pre-emption Detector
18/2 Pair	.26	7	.07	44	Microwave Detector
14/3	.34	9	.09	60	Audible Pedestrian Signal
14/5	.41	11	.13	90	One-Way Traffic Signal, Railroad Pre-emption, Hardware Pre-emption, Non Closed Loop Interconnect
14/7	.45	12	.16	110	Pedestrian Signal, One-Way Traffic Signal
14/9	.52	14	.21	140	One-Way and Two-Way Traffic Signal
14/12	.61	16	.29	190	Two-Way and Three-Way Traffic Signal
14/15	.70	18	.38	250	Three-Way and Four-Way Traffic Signal
14/21	.82	20	.53	330	Four-Way Traffic Signal, Cable Closure
14/25	.87	23	.59	390	Cable Closure
8/2, 6/2					Unmetered Service, Luminaire Service
8/3, 6/3					Metered Service
16/6 Pair	.76	19	.45	290	Closed Loop System Interconnect

Figure 15-2 Traffic Signal Cables

Utility Considerations

There are many utility companies that serve the residents and businesses of Connecticut. The utility companies the designer will be most concerned with during a signal design are the power company/municipal service and the telephone company. They own and maintain the distribution equipment throughout Connecticut. The distribution equipment (cables, messenger strand, transformers, conduits, etc.), known in the industry as outside plant, is present at almost every intersection that either has or will have a traffic signal. There are two major Companies and several municipal owned power services. They are listed in **Figure 15-3**, and **Figure 15-4** and the towns and areas that they serve are shown on

Figure 15-5. For a full list of the utility companies by town, go to the Division of Design Services, Utility Section on the DOT website. Power companies and municipal service departments will be subsequently referred to as the “Company”.

Utility Companies

When a traffic signal installation is due to a roadway or bridge construction project, the prime designer will initiate contact with the utility companies and schedule a utility meeting. The signal designer should then coordinate the signal design with the utility engineers that are assigned to the project.

When a traffic signal installation is not part of a reconstruction project, the signal designer must initiate contact with the utility engineers. The following utility offices, phone numbers and information may be used for that purpose.

<u>PRIVATELY OWNED POWER COMPANIES</u>	<u>TYPE OF SERVICE</u>	<u>PHONE</u>
Bozrah Light and Power Company (BL&P) ¹	Unmetered	860 889-6888
Connecticut Light and Power (CL&P) ² www.cl-p.com/	Unmetered	860 665-5000 ³
United Illuminating (UI), Client Relations Center www.uinet.com/	Metered	800 722-5584

¹ BL & P is a subsidiary of Groton Utilities.

² CL & P is a subsidiary of Northeast Utilities.

³ Central switchboard in the Hartford, Sheldon Road office. See district phone numbers in **Figure 15-6**.

Figure 15-3 Privately Owned Power Companies

<u>MUNICIPAL OWNED POWER SERVICES</u>	<u>TYPE OF SERVICE</u>	<u>PHONE</u>
Groton Utilities (GU) www.grotonutilities.com	Unmetered	860 446-4000
Jewett City Electric Department ⁴	Metered	860 376-2955
South Norwalk Electric Works	Unmetered	203 866-4446
City of Norwich Gas and Electric Department	Unmetered	860 887-2555
Wallingford Department of Public Utilities, Electric Division www.town.wallingford.ct.us	Metered	203 294-2265

⁴ Jurisdiction is within the town of Griswold and is not large enough to show on

Figure 15-5.

Figure 15-4 Municipal Owned Power Services

There are two telephone companies that serve Connecticut. The Southern New England Telephone Company (SNET) serves most of Connecticut. The Verizon Communication Company serves the part of Greenwich west of the Mianus River. Below is the contact information for the two telephone companies.

Southern New England Telephone Co.
Outside Network Designer
Conduit Engineering
1441 North Colony Rd.
Meriden, CT 06450-4101
Telephone: (203) 238-5201
Fax: (203) 237-8902

Verizon Communications
Verizon Engineering
500 Summit Lake Road
Valhalla, NY 10595
Telephone: (914) 714-7973
Byram Section: (914) 741-8388

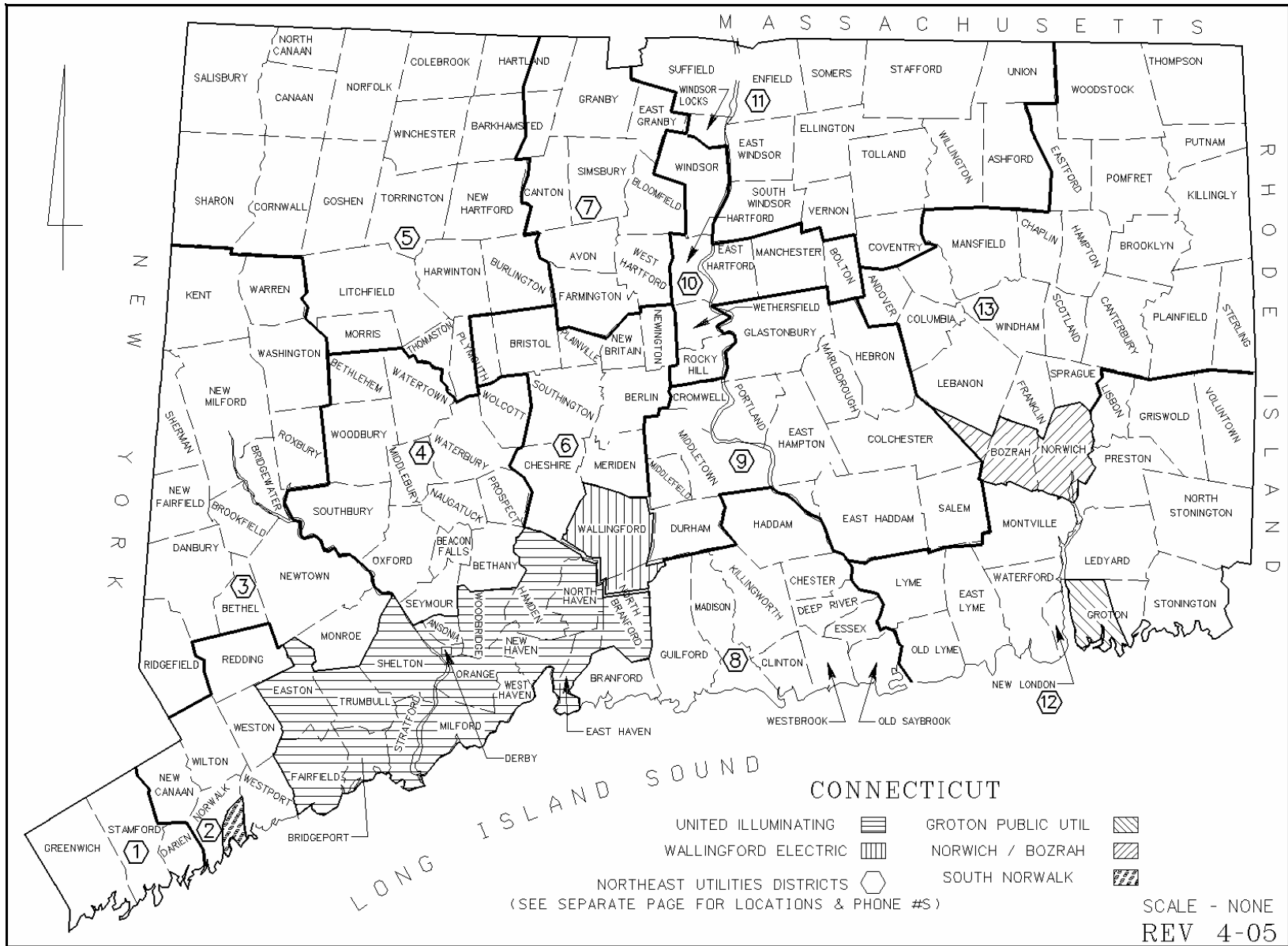

Figure 15-5 Power Company Jurisdiction in Connecticut

As shown in

Figure 15-5, Northeast Utilities serves the majority of towns and cities in Connecticut. Northeast Utilities has divided their service area into 13 districts, each with engineering offices. See **Figure 15-6** for a list of the districts and the phone numbers.

DISTRICT OFFICE AND LOCATION		PHONE
1	Stamford/Greenwich 626 Glenbrook Road, Stamford 06904	203 352-5489
2	Norwalk Tindall Avenue, Norwalk 06851	203 845-3484
3	Newtown/New Milford 20 Barnabus Road, Newtown 06470	203 270-5806
4	Waterbury 250 Freight Street, Waterbury 06702	203 597-4246
5	Torrington/Falls Village 69 Water Street, Torrington 06790	860 496-5278
6	Cheshire/ New Britain 705 West Johnson Avenue, Cheshire, 06410	203 271-4837
7	Simsbury 34 Hopmeadow Street, Simsbury 06070	860 651-2446
8	Madison 135 New Road, Madison 06443	203 245-5408
9	Middletown/East Hampton 49 Randolph Road, Middletown 06457	860 638-2206
10	Hartford 400 Sheldon Street, Hartford 06106	860 280-2445
11	Tolland/Enfield 1654 King Street, Enfield 06083	860 871-3560
12	New London 12 Masonic Street, New London 06320	860 447-5750
13	Willimantic/Danielson 1270 Main Street, Willimantic 06226	860 456-5027

Figure 15-6 Northeast Utilities District Offices and Locations

Use of Utility Poles

As previously discussed in the Support Structure sub-section of this manual, one or more utility poles may be used to support a span wire. There are certain regulations and clearances that the designer must observe when this is done. See DPUC Regulations 16.243 “Construction and Maintenance Standards Governing Traffic Signals Attached to Public Service Company Poles”. Prior to discussing the regulations, clearances and guidelines, there is some background information on utility pole construction the designer should know.

The utility company that owns the pole is considered the custodian. The custodian is responsible to replace the pole due to age, damage or other reasons. Metal letters identifying the custodian and metal numbers identifying the pole number are nailed onto the pole.

Important information regarding each pole is branded onto the pole by the pole supplier. The brand contains a code identifying the species of tree, the type of preservative used, year of treatment, the circumference (class), and length. The length and class may be helpful to the signal designer when discussing a proposed span attachment with the utility companies. The brand, on poles up to 50 feet in length, is located 10 feet (2.1 m) from the butt end. **Figure 15-7** shows typical pole data.

<u>POLE HEIGHT</u>	<u>SETTING DEPTH</u>	<u>COMMUNICATION MAX HEIGHT</u> ¹	<u>POWER MIN HEIGHT</u> ¹
35'	6'	21' 2"	24' 6"
40'	6'	23' 8"	27' 0"
45'	6' 6"	25' 11"	29' 3"
50'	7'	28' 2"	31' 6"

¹ Height may be adjusted depending on the mutual ownership agreement.

Figure 15-7 Utility Pole Data

A utility company other than the custodian may purchase space on the pole for their facilities which results in joint ownership. An agreement is reached between the power company and the communication companies as to the percentage of available space that each may use. There is generally more than one utility company on a pole.

Section 16-243-8 of the DPUC regulations describes the clearance requirements for conductors attached to a utility pole. To illustrate this, see **Figure 15-8**. This is a typical pole construction with a traffic signal span attachment. NESC rule 235 requires a 40 inch (1.0 m) clearance between the highest communication cable and the lowest power (supply) cables. This is considered a “communication worker safety zone”. If these clearances are not present and cannot be met by adjusting the existing cables, consider replacing the pole with a taller one. The designer should be familiar with certain exceptions to the regulations. In the interest of safety, the designer is also obligated to correct any existing clearance violations that are found on poles that will be used in the design. Below are some options if the proper clearances cannot be provided.

- Request relocation of the affected utility cables.
- Request reconstruction of the pole top with out-rigged cross arm away from span attachment or a pole top extension.
- Replace one or more utility poles with taller poles.
- Alter the span design to avoid creating a conflict.

Utility pole construction depends on a variety on factors which cannot be discussed here. All reconstruction must be agreed upon by both the power company and the telephone company.

Typical Utility Pole Construction

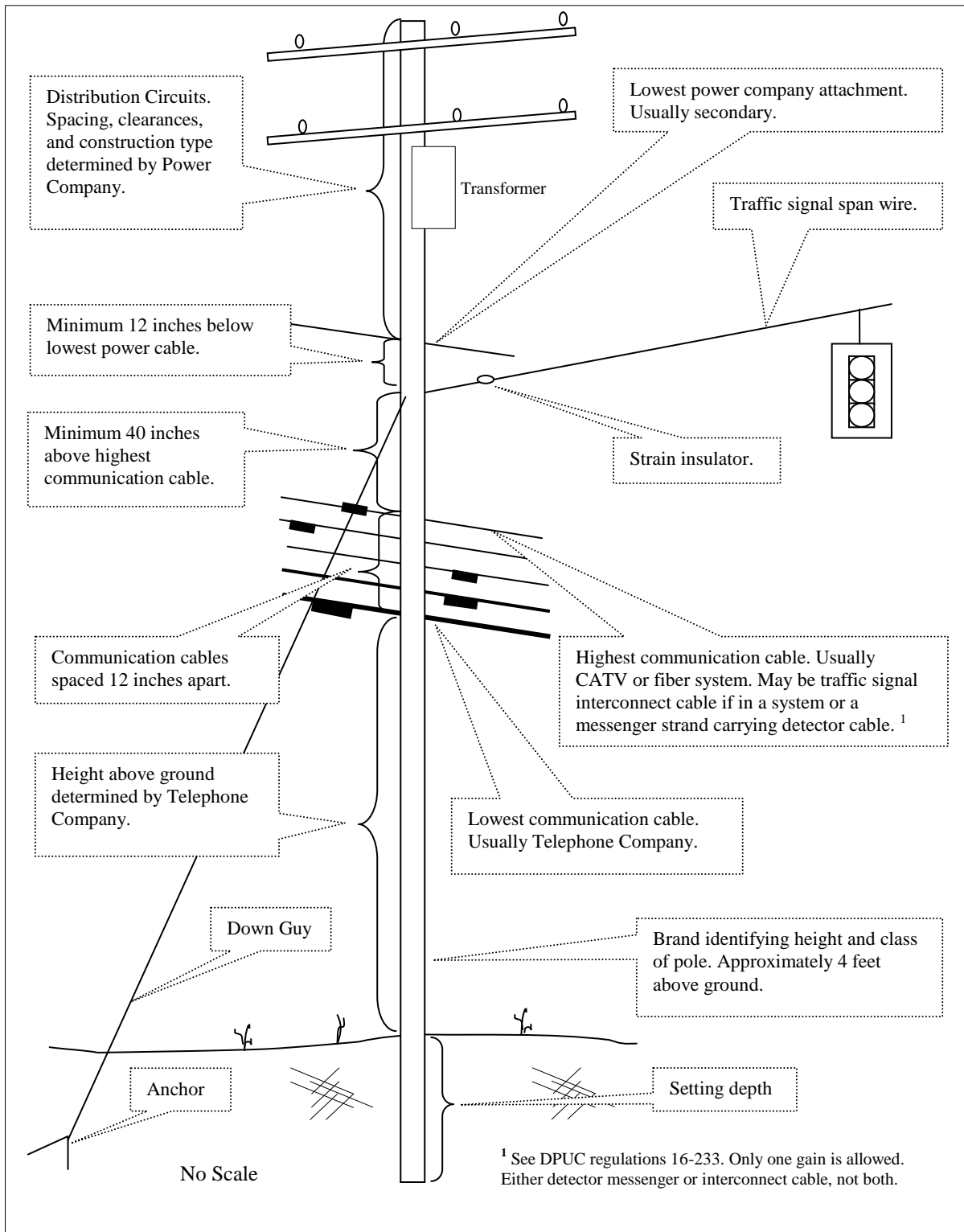

Figure 15-8 Typical Utility Pole Construction

A dilemma zone design will require vehicle detection a considerable distance from the intersection. If an ILD system is desired, the designer has a choice to install the lead-in cable, from the intersection to the detectors, either overhead or underground. If underground, there will be a high cost for trenching and RMC in-trench for the lead-in cable. Therefore the designer should always consider the use of a messenger strand between two or more poles to support the detector cable overhead. The clearances in NESC rule 235 govern here also. There must be a minimum 40 inches (1.0 m) between power and communication cables. The proposed messenger must be attached a minimum 12 inches (0.3 m) above the highest communications cable and 40 inches (1.0 m) below the power cable. This will place the cable in the communications gain. It is important to note that the traffic signal span wire is considered a power cable. If a span wire is present, it must be attached a minimum 12 inches below the other power cables.

When a span wire is attached to a utility pole, an anchor and down-guy is generally required to offset the load on the pole. In accordance with DPUC regulation 16-243-6, the power company will determine the guying strand size and location. Occasionally the pole in question will have primary cables and communication cables in three or more directions. In that case, the power company may determine that an anchor for a traffic signal is not needed. The distance between the pole and the anchor, called the “lead”, depends on the available ROW and conditions behind the pole. A down-guy for a traffic signal typically has 15 feet to 20 feet (4.5 m to 6.0 m) of lead. If ROW is not available, an easement should be pursued by the detector. If other conditions, such as a wetlands or a significant down slope prevent a normal anchor, a sidewalk anchor may be used. The sidewalk anchor needs less lead distance. If there is insufficient ROW even for a sidewalk anchor, head-guys to adjacent poles (pole-to-pole guy) may be used to bisect and transfer the load. The adjacent poles may then be anchored and guyed. See **Figure 15-9**. A tree should never be used as a traffic signal anchor. As well as determining the guying requirements, the power company will also provide and install the anchor, guy and necessary hardware.

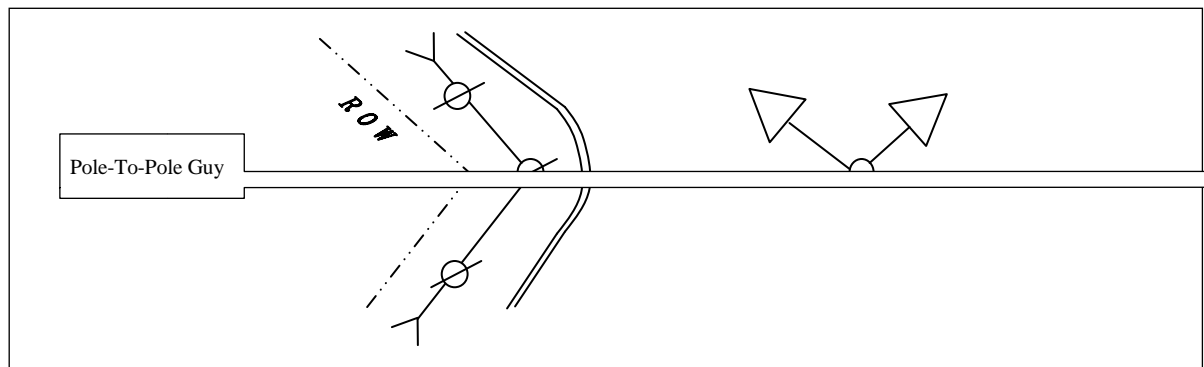

Figure 15-9 Pole-To-Pole Guy

Overhead

The proposed span wire must have the proper clearance to other cables within the intersection. Section 233 of the NESC addresses mid-span vertical and horizontal clearances. A span wire supporting signal cable is classified by the NESC as a 230C3 cable. Normally the span is high enough not to conflict with communication cables and low enough not to conflict with power cables. Unusual conditions such as low primary conductors or a high span wire will require corrective action. The designer should calculate the height of the proposed span where it will cross other cables. Anticipated conflicts should be discussed during the utility meeting. For safety reasons a 10 foot (3 m) clearance to primary cables is desired. The suspended traffic signals must also have sufficient horizontal clearance to communication cables to prevent contact during high winds. A minimum 4 feet (1.2 m) is recommended.

A mast arm signal design usually does not introduce the utility clearance concerns that a span wire design does. There are no attachments to poles and, if the mast arm structure is not the combination type (with a luminaire), it is not near the primary cables. The major concern of a mast arm signal design is the heights of communication cables where the arm will cross through. A mast arm with fixed-mounted signals is usually at the same elevation as communication cables, between 18 feet and 19 feet (5.5 m and 5.8 m) above the road. DPUC Section 16-243-8 requires a minimum 12 inch (0.3 m) clearance to communication cables. The designer should always measure the height of the cables and compare this to the estimated height of the proposed arm. A cross section diagram showing the arm and all communication cables is helpful. If a potential conflict is found, the designer should request that the cables be raised or lowered. If one or more utility poles must be replaced to provide the clearance, the designer may consider a free-swinging signal design. A free-swinging signal design allows the arm to pass above the communication cables. The arm is usually between 20 feet and 23 feet (6.0 m and 6.9 m) above the road. As in a span wire design, the suspended signals and signs should not be near communication cables. A minimum 3 feet (0.9 m) of horizontal clearance is needed to prevent contact during high wind conditions.

Interconnect installation guidelines, including the use messenger and cable extension brackets, are discussed in the Interconnect section.

Beneath Transmission Lines

Alternating current flowing through a conductor will create an electrical field in the space around the conductor. The field from a distribution voltage circuit has little effect on an adjacent traffic signal. Transmission lines however, have extremely high voltage and current. The effect of an electrical field from transmission lines may damage electronic equipment and be hazardous to people.

There are certain conditions the designer must consider when a traffic signal is located beneath or adjacent to power company transmission lines. The electric field created by the high voltage in the lines (up to 345 kv) will induce a voltage in any conductive material nearby. The induced voltage level depends on the transmission line voltage, the proximity of the object to the lines, and the orientation of the object to the lines, e.g., a span wire or mast arm parallel to the lines will receive a higher charge than one perpendicular. Normally the induced voltage is dissipated by draining the current to ground, however material that is not grounded properly will develop a discernable electrical charge.

Traffic signal appurtenances, including conduit, should not be placed within 50 feet (15 m) of a transmission support structure. Consult with the transmission line owner regarding the signal design. Include in the design all recommended material and actions to reduce, and eliminate if possible, the induced voltage. This may include additional ground rods, bonding wire, or a ground grid. In addition include all recommended installation procedures such as keeping a mast arm assembly grounded during erection.

Underground

The location of underground utilities is critical in the vicinity of a proposed foundation of a controller, steel pole, or mast arm. The most common utilities encountered are natural gas, water, and sewer lines. In urban or downtown areas, power and communication conduit systems are common. The cost to relocate existing utilities preclude that option unless absolutely necessary. A roadway reconstruction project however, may allow the relocation of utilities to accommodate a pole foundation. Otherwise all underground utilities should be avoided.

There are many clues that indicate the presence of underground utilities that the designer should be aware of during the field survey. Manhole covers (power and communication) or gas vent pipes indicate a vault which may be quite large. Primary risers, communication risers, gas gates, water gates, AT&T and SNET identification posts, a recently patched trench, are a few other visual indications. The field survey should not be restricted to just the intersection under design. An inspection of the road and sidewalk area a short distance each side, may also provide evidence to the location of underground utilities.

The Call-Before-You-Dig (abbreviated as CBYD or sometimes incorrectly as CBUD) system does not locate underground utilities for an engineer during the design stage. Occasionally however, old mark-outs will still be visible at an intersection from a recent excavation. Old mark outs should not be relied on to accurately locate underground utilities. They may be used as a guide only. The CBYD system uses different color paint for each type of utility. See the CBYD color code table, **Figure 15-10**. If the location of underground utilities is suspected in the area of a proposed pole or mast arm foundation, the utility company should be contacted to determine the exact location. Test pits may also be done to establish the exact location of an underground utility.

<u>CALL-BEFORE-YOU-DIG COLOR CODE</u>	
<u>COLOR</u>	<u>UTILITY</u>
Red	Electric Power Lines and Conduits
Yellow	Gas, Petroleum Products, Steam, Other Hazardous Liquids
Blue	Water
Green	Sewer
Orange	Communication Cables and Conduits, Fiber, Cable TV
Purple	Radioactive Material
Pink	Temporary Survey
White	Proposed Excavation

Figure 15-10 Call-Before-You-Dig Color Code

Utility Meeting

Section 16-243-9 of the DPUC regulations briefly describes a field utility meeting. The purpose of the meeting is to inform the utility companies of the proposed work and identify and resolve all conflicts between the traffic signal and utility facilities. Prior to the meeting the designer should prepare and be ready to provide to each utility engineer the following information and/or document.

- A preliminary design plan showing the proposed location of steel poles or mast arm assemblies with ties or if available, station number and offset.
- The estimated height of any span attachments to utility poles.
- The estimated load (tension) that the span will place on a utility pole.
- The estimated height of the span wire or mast arm where it will cross through existing utility cables. A cross-section sketch is recommended.
- The estimated electrical load of the traffic signal.
- The party responsible for the electrical energy to operate the traffic signal.
- The reimbursable percentage of all utility work and the party responsible for payment.
- The construction schedule.

This manual cannot discuss all possible utility situations the designer may encounter. The following subjects should be used as a guideline when conducting a utility meeting.

- Electric service, type (metered or unmetered) and source.
- Proposed steel pole/mast arm assemblies location.
- Span wire attachment to poles and the necessary anchors and guys.
- Potential mid-span crossing conflicts with utility cables.
- Conduit attachment to poles and the need for stand-off brackets.
- Telephone service source.
- Messenger and detector cable attachment to poles for arterial detection.
- Interconnect cable attachment to poles.

The designer must leave a copy of the preliminary plan with the utility company engineer showing all utility pole attachments, span wire crossing points (with estimated heights), risers, anchors, etc.. The designer should also request from the power and telephone company a cost estimate (by letter or e-mail) for the work they will perform.

It is recommended to complete a report-of-meeting document. The report should list all subjects discussed (even if there is no action required), including all agreements, responsibilities and resolutions to anticipated conflicts. The designer should send a copy to all interested parties (whether in attendance or not) along with a copy of the final signal design. If personnel changes are made before construction begins (by the utility company or the signal designer) the report-of-meeting will be very beneficial to the replacement engineer.

Electric Service

Source

The most convenient and most common service source is a utility pole or a mid-span tap to secondary cable. Occasionally an underground vault or secondary conduit system may be more convenient. All power company service requirements should be discussed and agreed upon during the utility meeting. Although the DPUC construction standards, section 16-243-6, allow line and load conductors in the same conduit, the Division of Traffic Engineering does not. All service (line) conductors to a traffic control cabinet must be contained in a dedicated RMC with no other cables. The service is never direct buried. The size of the conduit is usually 2 inch (50mm).

Traffic Signal Requirements

The electrical service needed to operate a traffic signal is 120 VAC. Because low power LED traffic and pedestrian indications are now standard, the load will never exceed 2000 watts even at a large intersection. Normally #8 AWG, Type SE (Service Entrance), copper conductors is adequate and is the Department's standard. Copper clad aluminum or aluminum conductors are not used. Occasionally #6 AWG or larger conductors are used to reduce line losses where the CA is a considerable distance from the service source. If this is the case, Chapter 9, Table 9, of the NEC or the table in **Figure 15-11** may be used to calculate anticipated voltage loss in the service cable.

<u>CONDUCTOR SIZE</u>	<u>AC RESISTANCE PER 1000 FEET (305 M)</u>
# 8 AWG	0.78 Ohms
# 6 AWG	0.49 Ohms
# 4 AWG	0.31 Ohms

Figure 15-11 Service Conductor Resistance

Metered

The electric service to a traffic signal may be either metered or unmetered depending on the serving Company's regulations. See **Figure 15-3** and **Figure 15-4**. A metered service provides an accurate monthly bill as well as a method of monitoring when the load has been increased, decreased or disconnected. The Company installs, owns, and maintains the line-side conductors of a metered service, therefore the designer must ensure the line conductors are installed directly from the source to the meter enclosure. They should not enter the CA prior to entering the meter enclosure. The meter requires 240 volts to operate therefore three conductors are used and shown on the plan as 8/3. On the load-side of the meter, only one side of the 240 volt line is connected to the main breaker in the CA. The type of service, "metered", must be indicated on the signal plan. When a metered service is needed from CL&P, a 3 inch (75mm) conduit is installed from the source to the meter enclosure. A 2 inch (50mm) RMC is recommended in Jewett City, UI and Wallingford Electric areas.

Unmetered

An unmetered service is preferred by most Companies because typically the load of a traffic signal is consistent month-to-month and there is no need to install, maintain, and read a meter. It is the most common type and also the least expensive to install. It is billed at a different rate and the customer is obligated to notify the Company, in writing, of all load changes within 30 days. The signal owner also owns the conduit and service conductors up to the point where they are connected to the utility company's secondary service. Only two conductors are needed and are typically shown on the plan as 8/2. The type of service, "unmetered", must be indicated on the signal plan.

Request for Service/Power Letter

For all new, relocated, or removed services, the Company requires a **Request for Service** form to be completed and submitted prior to scheduling the work. This document contains specific information about the traffic signal such as location, equipment description, estimated load, applicant, and customer to be billed. The Department uses a program known as the Signal Inventory to generate the Request for Service forms. The Signal Inventory was created to compile pertinent information on all traffic signals. An important function of the Signal Inventory program is to generate a standard Request for Service form, recognizable by all power companies, municipalities, and customers in Connecticut.

The program also generates the **Power Letter** which is a document that is similar to the Request for Service but also has the account number, meter number (if metered service), and the effective billing date. After the traffic signal installation or revision is completed, the Power Letter is sent to the Company with a copy to the customer.

All traffic signals that are on a state route are listed in the Signal Inventory data base. The data base is continuously updated by Department employees as new signals are installed and as existing signals are revised. Request for Service forms and Power Letters for traffic signals on state routes are generally completed by a Division of Traffic Engineering, Electrical Engineer. Consultant Engineers do not have access to the Signal Inventory. Intersections not on State routes and that do not have a six digit location number, are not in the data base. The Department cannot generate a request for service or issue a power letter for these signals. The necessary documents for service and subsequent billing updates are the responsibility of the Consultant Engineer or a municipal official.

Telephone Service

Occasionally a traffic signal will need a telephone service to communicate with an operation center, a maintenance office and/or a traffic engineering office, e.g., a closed loop interconnect system master. The closed loop interconnect system currently in use by the Department requires a dial-up voice grade connection at the master. A data circuit at each location, which was required for the UTC System, is no longer needed. The designer should discuss the telephone drop with the serving telephone company during the utility meeting. Below are design guidelines.

An auxiliary termination cabinet (ATC) is used to terminate the telephone cable. It allows access to the cable by the Telephone Company technician without opening the CA door. It is attached to left side of the CA when facing the door. A municipal owned installation may not require an ATC.

The telephone company technician will install the service, therefore a dedicated conduit (usually 1 ½ inch (38 mm)) directly from the utility pole or manhole to the ATC should be shown on the plan. The service (as all communication circuits) shall not be placed in conduit with other utilities, on a span wire, or in a steel pole along with signal cables. The dedicated conduit should also have a pull rope for the telephone company technician.

If it is a State owned system, a telephone service request must be completed and forwarded to the Office of Property and Facilities. The request contains information such as the location, pole number, coding for payment, and DOT contact person. If it is a municipal system, a town official or representative makes arrangements with the telephone company for service.

Powered Signs

A warning sign may either have one-section indications attached that flash yellow or may be internally illuminated. Solar powered flashing signs are not used by the Department as a permanent installation and are also not discussed here. Solar powered flashing signs however may be used as a temporary warning device. All permanent signs that have flashing signals or that are internally illuminated require a 120 VAC supply either from the CA or directly from the local utility company. The type of sign that is desired will dictate the electrical design. Variable Message Signs (VMS) or Changeable Message Signs (CMS) used in Connecticut's IMS, are not part of a traffic signal installation and are not discussed here. Below are the different types of signs and the design guidelines.

Alternate Flashing Signals on Warning Sign

Type A: One-way signal sections that flash alternately are attached to a road-side, post mounted warning sign to draw attention to the message. The signals flash 24 hours a day. This type may or may not be associated with a traffic signal. For maintenance and billing purposes this type of flashing sign is considered a separate location, even if associated with a nearby signalized intersection. It should have its own intersection number, secondary service, protected disconnect (flasher cabinet), and account number.

Type B: Similar in construction to Type A, this warning sign is placed in advance of a traffic signal. For the design/operation of this type of sign refer to the “Flashing Message Sign” chapter of this manual. The warning sign message is usually “When Flashing Stop Ahead”. It is powered by and controlled by the traffic controller. It should be connected to the CA with a 14/5 cable. It is considered part of the traffic signal therefore a separate intersection number, flasher cabinet, secondary service and account number are not needed.

Type C: A side mounted mid-block, pedestrian crossing sign is a special installation; privately or municipally owned. The signals flash when actuated by a pedestrian. If on a State road the installation should have its own intersection number, secondary service, and account number.

Internally Illuminated Warning or Advisory Sign

These are usually rigid mounted overhead (on a support structure or bridge overpass), or side mounted on a support structure. If span mounted they should be tethered to reduce movement and ensure proper alignment. The message or symbol is “blanked-out” and cannot be seen until it is illuminated. The symbol or message is illuminated by either fiber optics or by LEDs so power consumption is less than 300 watts. The operation of an internally illuminated sign is generally associated and directly related to the operation of the traffic signal.

Type D: The most common internally illuminated sign is the flashing stop-ahead sign. It is a blank-out design so that the words “Stop Ahead” cannot be seen until the sign flashes. For the design/operation of this type of sign refer to the “Flashing Message Sign” chapter of this manual. It should be connected to the CA with a 14/5 cable. It is considered part of the traffic signal therefore a separate intersection number, flasher cabinet, secondary service and account number are not needed.

Type E: A changeable lane use sign may occasionally be associated with a traffic signal. If one or more is needed, the designer must specify the legend and/or symbol and size. Each message will require a separate conductor. A 14/5 cable is generally sufficient. The sign is considered part of the traffic signal therefore a separate intersection number, secondary service and account number is not needed.

Type F: A “No Left Turn” and/or “No Right Turn” sign is sometimes used at intersections that have railroad pre-emption to restrict vehicles from turning onto the tracks. These are placed on an approach where the turn is normally allowed. This type of sign is also considered part of the traffic signal therefore a separate intersection number, secondary service and account number is not needed.

Interconnect

Type

Interconnect is the medium over which signals in a system communicate. The time base system will not be discussed in this section since it does not require an interconnect. There are three types of interconnect that are predominant in Connecticut. Most widely used is a shielded, twisted pair, copper cable. The other types are fiber optic cable and spread spectrum radio frequency (RF). The Department primarily uses twisted pair cable for data transfer in a closed loop system. Municipalities have chosen to use copper cable, fiber, RF or a combination of the different types. A non closed loop system such as a master/slave does not require data transfer therefore does not require a shielded, twisted pair communication cable. A signal cable may be used to transmit the yield command from the master to the slave(s).

As previously discussed in the “Signal Systems” chapter of this manual, the designer should determine the type of system and if closed loop, the interconnect type. Signals added to an existing system should have the same type as the existing system unless there are circumstances or a physical obstruction which makes another type more practical, e.g., an RF type will avoid cable installation over a movable bridge. The electrical characteristics and design guidelines of each type are discussed below.

Twisted Pair Cable

There are currently 95 State owned, arterial closed loop systems in Connecticut which include over 840 intersections. The communication method is full duplex over shielded, twisted pair copper cable. If installed overhead on utility poles the trunk circuit is usually a figure 8 type cable. The support strand is molded into the polyurethane jacket above the conductor cable so that a cross section view of the cable resembles a figure 8. Most 12 pair trunk circuits have 6 pair reserved for municipal use. The installation and splicing method is easy and requires no specialized training. Modems or patch panels are not needed as in a fiber or RF system.

The twisted pair cable is classified as communication cable and when installed overhead on utility poles, must be installed in the communication space directly above the highest communication cable which is usually a Cable TV cable. A 12 inch (0.3m) clearance to the highest communication cable and a 40 inch (1.0m) clearance to the lowest power company attachment (usually secondary service) is required. Refer to NESC Table 235-5. A cable extension bracket is available in various lengths, which may be used to obtain the clearance and avoid a pole change. The designer must review each pole with the utility companies and determine any make-ready work necessary to meet these clearances. The interconnect attachment points and necessary utility work should be documented in a table and included either in the special provisions or on the plans. See the example in **Figure 15-12**. When more than a few poles are used, an interconnect plan should be developed. This plan will include but not be limited to showing all intersections, utility poles, cable closures, drop cables, and all pertinent construction notes.

Fiber Optic Cable

Several municipalities in Connecticut use fiber optic cable for interconnect systems. Currently the Department does not. There are several types of fiber optic (FO) cables available. The fiber may be installed overhead on utility poles or underground in a duct system. If installed overhead, the designer has several installation options and, as always, should consult with the municipality regarding the installation method. The FO cable may be supported by rings from a steel messenger strand; may be wrapped to a steel support strand; may be self supported by a synthetic aramid fiber strand; or may be placed in an aerial duct system. There are advantages and disadvantages to each method. The FO cable is dielectric i.e. it does not conduct electricity and the communication contained in the cable is not affected by stray or induced voltage. However if a steel support strand is used the strand has to be bonded and grounded in accordance with the NESC section 9 and 215.

The NESC rule 230F allows FO cable to be classified as either supply or communication and therefore can be installed on the pole in either the power space or the communication space. If installed in the power space the FO cable must have the proper clearance to communication facilities. If installed in the communication space, the FO cable must have the proper clearance to supply facilities. The guidelines previously discussed for the twisted pair cable regarding clearances, attachment list, and interconnect plan, apply for the FO cable as well.

Signal Cable

Although rarely used, a non closed loop system such as the master/slave, may be the most appropriate for a particular condition. Signal cable may be used as interconnect. It is not a communication circuit and it is not necessary to keep it separate from other power cables. It may be installed on utility poles supported by a messenger strand. The clearances and installation guidelines are the same as detector cable which is previously discussed in the "Use of Utility Poles" subsection. The detector cable and interconnect may share the same gain and be supported by the same messenger.

INTERCONNECT CABLE ATTACHMENT LIST

Town:
Route:
Direction:
Sheet ____ **of** ____

<u>POLE NUMBER</u>	<u>PROPOSED ATTACHMENT POINT</u>	<u>COMMENTS</u>
SNET 1234	1 foot (0.3m) above CATV	A, C, D
SNET 1235	1 foot (0.3m) above CATV	B
SNET 1236	1 foot (0.3m) above CATV	I
SNET 1237	Attachment point vacated by CATV	F
SNET 1238	Attachment point vacated by CATV	E, F
CL&P 9876	Extension Bracket 1 Foot (0.3m) above CATV	
CL&P 9875	Extension Bracket 1 Foot (0.3m) above CATV	D
CL&P 9874	Attachment point vacated by CATV	F, H
CL&P 9873	1 foot (0.3m) above CATV	H
CL&P 9872	1 foot (0.3m) above CATV	H
SNET 2345	Attachment point vacated by SNET	E
SNET 2346	1 foot (0.3m) above SNET	G
SNET 2347	1 foot (0.3m) above SNET	D
GU 876	1 foot (0.3m) above CATV	
GU 875	Attachment point vacated by CATV	E, F
GU 874	1 foot (0.3m) above CATV	
GU 873	Extension Bracket 1 Foot (0.3m) above CATV	A, C, D, J

COMMENTS

Install interconnect cable on the street side of pole unless otherwise specified as Field Side or Dead End.

- A Dead-End interconnect cable with thru bolt.
- B Field Side.
- C Refer to Typical Installation Sheet, Bonding and Grounding Requirements, Item 1.
- D Refer to Typical Installation Sheet, Bonding and Grounding Requirements, Item 2.
- E SNET to lower 1 foot (0.3m).
- F CATV to lower 1 foot (0.3m).
- G SNET to replace pole.
- H CL& P to replace 3 spool open secondary rack with triplex.
- I CL& P to raise secondary 1.5 feet (0.5m).
- J Groton Utilities to replace pole.

Figure 15-12 Interconnect Cable Attachment List

Structural Design for Span Poles

NOTE: This section is only applicable for:

- Calculating design tension when attaching to utility poles
- As part of the evaluation when determining if a modification to span loading using steel span poles installed prior to 2014 will exceed the current loading. Refer to Chapter 10 (Existing Span Pole Assemblies)

New span pole designs should follow the procedure listed elsewhere in this manual.

The designer must specify a steel pole that will provide an attachment height high enough to allow a signal clearance of at least 16 feet (4.8 m) over the road. As when determining the mast arm assembly pole height and attachment point, the designer must consider the elevation of the proposed foundation in relation to the road surface. The Department has a list of standard steel poles based on length, strength and bolt circle. See the span wire design guidelines in the “Signal Support Structures” section. As well as determining the height, the designer must calculate the horizontal tension (Design Tension) on the pole to confirm that the standard design load-at-yield is adequate. The next page is the accepted method of calculating the Design Tension.

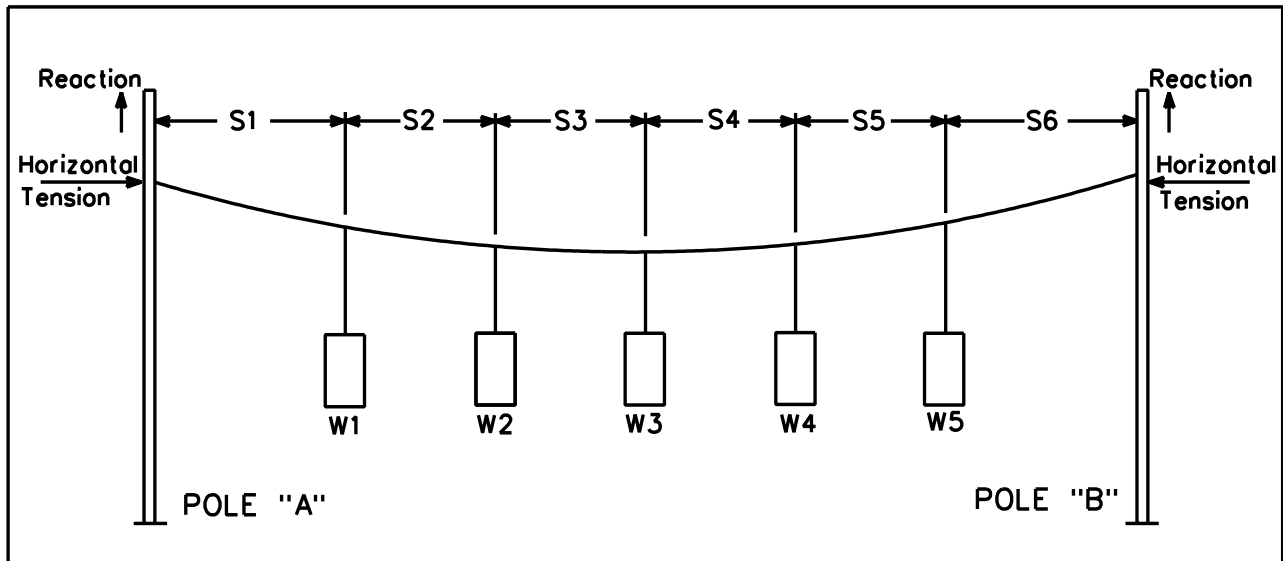

<u>SIGNAL SECTION</u>	<u>WEIGHT</u>		<u>OUTSIDE DIMENSION</u>	
8 inch (200 mm)	7.5 lb.	33 N ¹	10 inches	250 mm
12 inch (300 mm)	15 lb.	67 N	14 inches	350 mm

<u>SIGNAL HARDWARE</u>	<u>WEIGHT</u>		<u>LENGTH</u>	
1 Way Hanger	10 lb.	45 N	12 inches	300 mm
2 Way Hanger	20 lb.	90 N	12 inches	300 mm
3 Way Hanger	25 lb.	110 N	12 inches	300 mm
4 Way Hanger	30 lb.	135 N	12 inches	300 mm
Span and Cable	1 lb./ft	14.5 N/m		

¹ Newton = 9.81 X Kilogram

SIGNAL ASSEMBLY LOADS

$$W_1 = \text{Signal Wt.} + \text{Hardware Wt.} + [(\text{Cable Wt.}) (S_1 + S_2/2)]$$

$$W_2 = \text{ " " } + \text{ " " } + [(\text{ " " }) (S_2 + S_3)/2]$$

$$W_3 = \text{ " " } + \text{ " " } + [(\text{ " " }) (S_3 + S_4)/2]$$

$$W_4 = \text{ " " } + \text{ " " } + [(\text{ " " }) (S_4 + S_5)/2]$$

$$W_5 = \text{ " " } + \text{ " " } + [(\text{ " " }) (S_5/2 + S_6)]$$

$$\text{Moments Pole A} = W_1 (S_1) + W_2 (S_1 + S_2) + W_3 (S_1 + S_2 + S_3) + W_4 (S_1 + S_2 + S_3 + S_4) + W_5 (S_1 + S_2 + S_3 + S_4 + S_5)$$

$$\text{Reaction Pole B} = \text{Moments Pole A} \div (S_1 + S_2 + S_3 + S_4 + S_5 + S_6)$$

$$\text{Moments Pole B} = W_5 (S_6) + W_4 (S_6 + S_5) + W_3 (S_6 + S_5 + S_4) + W_2 (S_6 + S_5 + S_4 + S_3) + W_1 (S_6 + S_5 + S_4 + S_3 + S_2)$$

$$\text{Reaction Pole A} = \text{Moments Pole B} \div (S_1 + S_2 + S_3 + S_4 + S_5 + S_6)$$

Check that the sum of the Loads equals the sum of the Reactions.

$$W_1 + W_2 + W_3 + W_4 + W_5 = \text{Reaction Pole A} + \text{Reaction Pole B}$$

Low Point = Reaction Pole B - W_5 - W_4 - W_3 - etc. until the answer is a negative number.
The last W subtracted is the Low Point.

Or

Reaction Pole A - W_1 - W_2 - W_3 - etc. until the answer is a negative number.
The last W subtracted is the Low Point.

Check that the Horizontal Tension on pole A equals the Horizontal Tension on pole B.

For the example below, assume the Low Point is W_3 .

$$\text{Sag} = 5 \% \text{ of span length} = (0.05) (S_1 + S_2 + S_3 + S_4 + S_5 + S_6)$$

$$\text{Horizontal Tension Pole A} = \frac{[(\text{Reaction Pole A}) (S_3 + S_2 + S_1) - W_2 (S_3) - W_1 (S_2 + S_3)]}{\text{Sag}} = T$$

$$\text{Horizontal Tension Pole B} = \frac{[(\text{Reaction Pole B}) (S_4 + S_5 + S_6) - W_4 (S_4) - W_5 (S_4 + S_5)]}{\text{Sag}} = T$$

Design Tension = 2.5 T

The Load-at-Yield of the selected pole must be greater than the calculated design tension.

Attachment Height = 17 feet (5.2 m)* + Sag + Total height of largest signal or signal at low point.

The pole height should be at least 1.5 feet (0.5 m) more than the attachment height.

* Desired clearance of signals over road. Acceptable clearance is 16 to 18 feet (4.8 to 5.5 m).

Plans, Specifications and Estimates

Plans

The Division of Traffic Engineering has traffic signal typical installation detail sheets that are available on the DOT website. The plans illustrate the construction methods for State owned traffic signals that the Contractor must follow. Familiarity with these is beneficial to the designer as well as the contractor. It should be noted that several municipalities have installation methods that are different than these. The designer must ensure the typical sheets are appropriate for the particular project and current. Details that are contradictory for the project should either be deleted or crossed through and labeled “NIC” (Not In Contract).

Specifications

A traffic signal is installed in accordance with the Department’s “Standard Specifications for Roads, Bridges and Incidental Construction” (currently the Form 816), and supplemental specifications. The supplemental specifications are issued twice a year, January and July and will eventually be included in the next edition of the Standard Specifications. In addition, special provisions to the Form 816 are often created to cover a special item, type of work, or to update an obsolete specification. Many special provisions that the Division of Traffic Engineering has developed and used are on the DOT website. These may be used when applicable or may be modified to address a special installation, e.g., when approved, proprietary material is specified for a municipality. When using a special provision the designer must ensure all work and material has a method of measurement and a basis of payment. The specification must be as clear and concise as possible. If ambiguous or contradictory to other contract documents, a change during construction may be necessary or a claim against the State may be filed, resulting in unnecessary costs.

The use of federal funds for full payment of proprietary material is generally not allowed. Federal-Aid Policy No. 23 CFR 635.411 “Material or Product Selection” describes when federal money may be used. If full payment is desired by the eventual owner, it must be formally requested and approved as described below. If not approved, the owner may choose to contribute to the contract the difference in cost between the proprietary product and the generic product.

- In letter form, submit the request for use of proprietary material.
- Address the request from the eventual owner or CE representing the owner, to the Manager of Traffic Engineering.
- List all desired proprietary materials. Include all pertinent information such as model number, revision number, etc.
- Clearly justify the need for proprietary materials.
- The request will be evaluated by Traffic Engineering and a recommendation forwarded to the Engineering Administrator or FHWA depending on project oversight.
- Once approved or denied, the owner will be notified of the decision.

- Upon approval, the manufacturer's name and product identification will be used in the specifications or on the plans.

If not approved, either the specification will remain generic or a cost sharing agreement may be pursued. If cost sharing is pursued, the difference in cost between the proprietary product and the generic product is determined. Historical unit price information is used to determine the cost of the generic product. The cost of the proprietary product is provided by the requestor.

Estimates

A list of established item numbers with descriptions and also a list of weighted-unit-prices, both in PDF form, is available on the DOT website.

A proposal estimate must be prepared which lists the total of all traffic signal items, quantities, and estimated prices. The proposal estimate is generated through the Bid Management Information System (BMIS). It is used to develop the item bid list. The estimated prices for a specific project are confidential and should not be divulged to any party outside the Department. A Detailed Estimate Sheet (DES) is also prepared in which the items are assigned to each intersection rather than a section of roadway defined by station numbers. As previously stated, these estimates are not necessary for privately funded signals designed for a development. They are necessary for publicly funded projects where the contract is awarded to the lowest bidder. The DES, along with the intersection plan and special provisions, provides each bidder a reasonably accurate representation of the work required at each intersection. A blank DES is available on the DOT website.

The following information will aid the designer in preparing a DES:

- The CADD cell library is TR_ESTIMATE.cel
- The naming convention is TR_EST_XXXX_XXXX.dgn, where the x's are the project number.
- Organize all item numbers in numerical order.
- The item name should perfectly match the proposal estimate and visa versa.
- When applicable, edit the top field to indicate "Federal Aid Participating".
- Do not include items that the pay unit is estimated "EST".

Example: Trafficperson (State Police Officer) pay unit is EST, therefore not listed.
Trafficperson (Uniformed Flagger) pay unit is Hr., therefore is listed.

Miscellaneous

Location Numbering System

The location numbering system was developed for traffic signals to eliminate the confusion that frequently occurs when an intersection is described by local street names. The system has since been expanded to include a variety of State owned and maintained installations on a State maintained road or highway. See **Figure 15-13** for the types of installations that have location numbers and the number range of each. A traffic signal location number (known as an intersection number) is a six digit, two part number, e.g., 123-234. The first three digits represent the town number (001 through 169). The next three are the location number. The numbering system has been extremely helpful in many ways such as organizing engineering/maintenance records, and updating utility bills. The Signal Inventory data base previously discussed in the Electric Service section, is where intersection numbers are created and updated.

TYPE OF INSTALLATION	LOCATION NUMBER RANGE
Traffic Signal or Powered Sign ¹ : State Owned on State Road Municipal Owned on State Road ²	XXX-201 through 499
Traffic Signal: Municipal Owned not on State Road ³	XXX-901 through 999
Weigh-In-Motion Site	XXX-701 through 799
Remote Weather Information System	XXX-701 through 799
Incident Management System: Variable Message Sign (VMS) VMS and Surveillance Camera Site Vehicle Detection Site	XXX-500 through 599 XXX-701 through 799 XXX-701 through 799
Cathodic Protection System	XXX-701 through 799
Other	XXX-

¹ Powered signs driven by the controller do not require an intersection number.

² Includes interstate and other expressway OFF ramps.

³ Only intersections that have an interstate and other expressway ON ramp and intersections that have railroad pre-emption. Otherwise location number is not assigned.

Figure 15-13 Location Numbering System

Uninterruptible Power Source

With the use of LED indications, the power requirements of a typical traffic signal are much less than when incandescent lamps were used. A properly Volt/Amps (VA) rated uninterruptible power source (UPS) will operate a traffic signal for a short time if there is an outage and will also provide another level of protection from spikes and surges on the service line. The Department has determined that the infrequent occurrence of a power outage does not justify the additional cost of installation and maintenance of an UPS. The Department does not allow a UPS on State owned signals. If a municipality desires a UPS at a critical intersection, the designer must develop specifications, such as VA rating and whether the UPS is “on-line” or “stand-by”, to suit the application and the owner’s requirements. The municipal officials must be aware of the future ownership and maintenance responsibilities. A UPS device contains batteries that periodically must be replaced. Also if the CA were to be struck by a vehicle, hazardous material (battery acid) may be released from the UPS device.

Illumination

Normally the roadway lighting system is separate from the traffic signal. The lighting system may be owned by the State, municipality or the serving power company. If there is no lighting system, spot roadway lighting may be desired and included in the traffic signal installation. Occasionally the location of a steel pole or mast arm assembly is such that a luminaire may be attached, eliminating a light standard. This design is preferred because it reduces the number of roadside fixed objects. The designer must consider several issues when including a luminaire in the signal design and should consult with the Department's Illumination and Electrical Section (Division of State Design).

- If the proposed luminaire will be part of an adjacent lighting system, determine the owner. Luminaries owned by the power company cannot be attached to steel poles or mast arms.
- Determine the type of luminaire. The type should match the adjacent type, e.g., it is not recommended to install a high-pressure-sodium type within a mercury-vapor type system.
- Determine the bracket length. When a luminaire is attached to a support structure, a combination structure is used which includes the luminaire bracket. The bracket length should be indicated on plans in the support structure data table.
- Determine the service source. If the party responsible for the traffic signal electricity is different than the party responsible for the illumination electricity, service should not be from the controller cabinet. If underground, a separate conduit from the pole base to the service source is needed. If a splice in an underground illumination circuit is required, do not make it in the pole base.

Use of Construction Notes

A construction note should be included whenever clarification or a specific instruction is needed for the contractor. Notes are especially helpful when a signal is revised and there is mixture of new and existing material. There is a list of common construction notes in the CADD cell library on the DOT website. As in all written instructions or specifications, the notes should be as clear and concise as possible to avoid ambiguity. The active-imperative voice is recommended. The notes are directed at the contractor therefore the phrase “The contractor shall” is not needed. An example is: “Splice segmented loops in series per lane”. Notes may also be used to identify work that is to be done by others such as the installation of a utility pole by CL & P. Do not add notes for work that is obvious. Try not to clutter up plans with repetitious notes. If it would be helpful to link the note with a specific area on the plan, use a letter within a hex symbol next to the note and place the symbol at the location on the plan.

Example: “ Install cast iron handhole cover”.

Use of Technical Notes

Technical notes are used by the designer to clarify or define an unusual operation. When the CA is fabricated to the specific intersection plan, the technical notes provide information that is necessary to the technician. The most common are non-standard skip notes.

Scrap and Salvaged Material

When an existing signal is revised or upgraded, the contractor is directed to remove all abandoned traffic signal equipment. The abandoned material is considered either scrap or salvage. Scrap material is not reusable, has little or no salvage value, and must be disposed of by the Contractor. Salvage material may be reusable or has a salvage value, e.g., controller unit or copper wire. The contractor is directed to return salvage material to the owner. The Department has predetermined which material is scrap and which is salvage from a State owned traffic signal. The types of material are listed in the special provision to the Form 816, Section 11.18. When a municipal owned traffic signal is revised or upgraded the designer must consult with the town official to determine what material will be returned to the town and where it should be delivered. The text of the special provision to the Form 816, Section 11.18 should be modified to account for the town owned salvage material.

Most of the scrap and salvage material is within the intersection and is apparent to the designer and to the Contractor. There may be material that is not apparent, e.g., handholes for dilemma zone detectors; pressure detector frames; messenger with detector, interconnect or pre-emption cable attached to utility poles; RMC risers; anchors and guy wires. The designer should review the existing plan of record and, during the field survey, identify any material that will be abandoned and may be overlooked by the contractor. It is recommended to list this material in a construction note and, if necessary, link to the location on the plan with a hex symbol.

16 SIGNAL PLAN LAYOUT

The following pages provide design guidelines and general considerations for completing the signal plan form. The designer should refer to specific sections of the design manual for detailed design information. Blank signal plan forms are available on the DOT's website.

The sequence and timing section follows two different formats, one for sequential phasing and one for dual ring or quad phasing. For sequential phasing, fill in the phases working from left to right. Phase 1 is typically reserved for an artery advance, phase 2 for the artery through movement and phase 3 for an exclusive pedestrian phase. For dual ring phasing or quad operation, pay particular attention to the phase numbers with respect to which movement is typically controlled by that phase.

The numbering of signal faces should always be split so that each leg of the intersection has different numbered signal faces. When designing a full or half quad type signal, number the signal faces to correspond to the phases. For ease of trouble shooting and/or inspecting a traffic signal, always number the signal faces with the corresponding phase where possible (this is not possible in two phase operation).

Drafting guidelines and requirements are detailed in the Drafting Guidelines section of this manual.

TYPICAL PHASE ASSIGNMENTS

DUAL RING OR QUAD OPERATION

- Ⓐ NO TURN ON RED INFORMATION (IF THERE ARE NO APPROACHES SIGNED INDICATE THE WORD "NONE")
- Ⓑ IF PHASE IS ALSO FOR PRE-EMPTION INDICATE IN THE UPPER PORTION OF THE PHASE BLOCK "PRE-EMPT.1", "PRE-EMPT. 2", ETC.
- ① ARTERY LEFT TURN PHASE
- ② ARTERY THROUGH PHASE
- ③ EXCLUSIVE PEDESTRIAN PHASE OR A SIDE STREET LEFT TURN PHASE
- ④ SIDE STREET THROUGH PHASE
- ⑤ ARTERY LEFT TURN PHASE
- ⑥ ARTERY THROUGH PHASE
- ⑦ SIDE STREET LEFT TURN PHASE
- ⑧ SIDE STREET THROUGH PHASE

SEE FIGURE 4-10 FOR PHASE ASSIGNMENTS FOR A DUAL QUAD WITH AN EXCLUSIVE PEDESTRIAN PHASE

MOVEMENT DIAGRAM																												
Ⓐ	Ⓑ				②	③	④	⑤	⑥	⑦	⑧																	
	①																											
NTOR	PHASE 1				PHASE 2			PHASE 3			PHASE 4			PHASE 5			PHASE 6			PHASE 7			PHASE 8					
	FLASH	GRN	CL	CL	GRN	CL	CL	GRN	CL	CL	GRN	CL	CL	GRN	CL	CL	GRN	CL	CL	GRN	CL	CL	GRN	CL	CL	GRN	CL	CL

Figure 16-1 Typical Phase Assignments

SEQUENCE AND TIMINGS

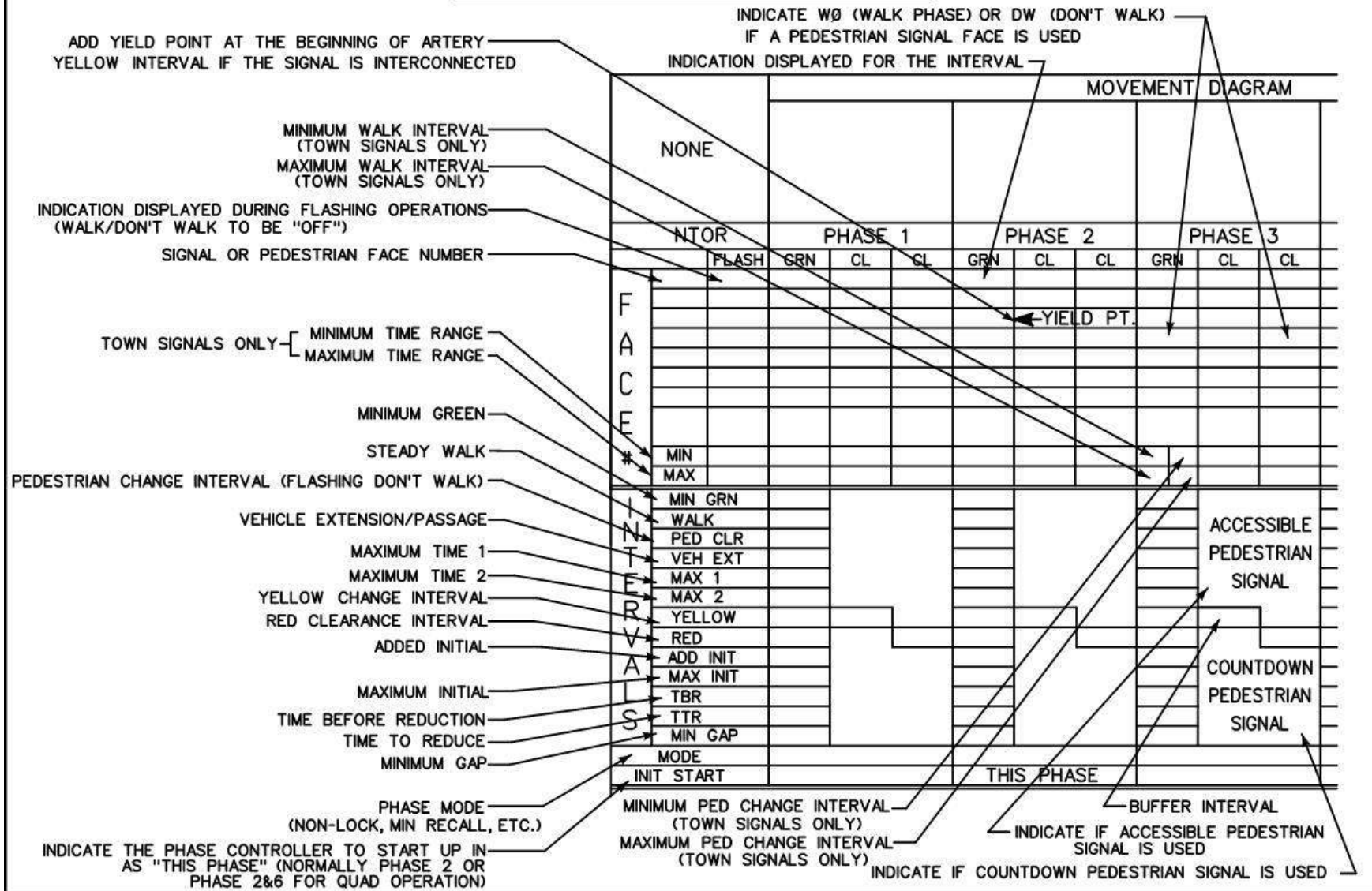

Figure 16-2 Sequence and Timings

- ① DETECTOR NUMBER
- ② DETECTOR SIZE (FOR LOOP DETECTORS), IF OTHER THAN LOOP INDICATE TYPE, EX. MAG., MICROWAVE, ETC
- ③ NUMBER OF TURNS (FOR LOOP DETECTORS)
- ④ DETECTOR MODE OR FEATURE (EX. PRESENCE, DELAY 8", ETC.)
- ⑤ COMPLETE PROGRAM INFORMATION. INDICATE WHEN MAX 1, MAX 2, FLASH AND THE PATTERNS WHICH WILL BE IN OPERATION
- ⑥ CYCLE LENGTH (IN SECONDS)
- ⑦ OFFSET IN SECONDS AND PERCENTAGE
- ⑧ * THE SPLIT FOR EACH PHASE
(PER CYCLE) IN SECONDS AND PERCENTAGE (CLOSED LOOP SYSTEMS ONLY).
- ⑨ COORDINATION TYPE. (INDICATE "NONE" IF NOT COORDINATED)
- ⑩ PERMISSIVE PERIOD BY PHASE IN SECONDS
- ⑪ INTERSECTION NUMBER OF THE MASTER
- ⑫ INTERSECTION NUMBERS OF OTHER SIGNALS IN SYSTEM
- ⑬ ADD TECHNICAL NOTES FOR UNIQUE OPERATIONS

* The number of seconds for each vehicle phase in the phase split section must equal or exceed the phase minimum plus clearance.

DETECTORS				PROGRAM			COORDINATION TYPE		PHASE SPLITS								PERMISS PERIOD	SYSTEM LOC	TECHNICAL NOTES				
IDENT	SIZE (WXL)	TURNS	MODE	FUNCTION	TIME	DAYS	CYCLE	OFFSET	SEC / %								SEC	MASTER	STANDARD OVERLAP SKIP FEATURES APPLY				
								SEC	%	Ø1	Ø2	Ø3	Ø4	Ø5	Ø6	Ø7	Ø8	Ø	SEC				

Figure 16-3 System Information Blocks

- ① INDICATE WHO WILL BE PAYING FOR THE ELECTRICITY NEEDED TO OPERATE THE SIGNAL
 - ② INDICATE MAINTENANCE LEVEL (APPLIES TO STATE OWNED SIGNALS ONLY)
 - ③ CLOSED LOOP SYSTEM ADDRESS
 - ④ SERVICE POLE OR MANHOLE NUMBER
 - ⑤ INSERT INTERSECTION NUMBER (000-000)
 - ⑥ COMPLETE OFFICE RECORD (SEE NEXT PAGE)
 - ⑦ FILL IN BLOCK (METERED OR UNMETERED SERVICE)
 - ⑧ PLACE SIGNAL HEADS AND PEDESTRIAN SIGNAL HEADS WITH SIZES AND NOTES FOR BACKPLATES, LOUVERS, TUNNEL VISORS, LED LAMPS, ETC.
 - ⑨ FILL IN BLOCK FOR EMERGENCY PRE-EMPTION (IF APPLICABLE)
 - ⑩ ADD NOTE "PROPERTY OWNER RESPONSIBLE FOR MAJOR COMPONENT REPLACEMENT" (IF APPLICABLE)
 - ⑪ IF IT WILL BE A TOWN SIGNAL THEN ADD HERE
 - ⑫ PROFESSIONAL ENGINEER'S STAMP FOR CONSULTANT DESIGN. CADD LOGO FOR D.O.T. DESIGN
 - ⑬ TOWN NAME AND INTERSECTION DESCRIPTION
 - ⑭ THIS AREA IS RESERVED FOR THE REVISION NUMBER ASSOCIATED WITH THE DATES AND SIGNATURES IN THE ADJACENT TITLE BLOCK (SEE NEXT PAGE)
 - ⑮ TRANSPORTATION ENGINEER'S INITIALS
 - ⑯ DRAFTER'S INITIALS
 - ⑰ CHECKER'S INITIALS
 - ⑱ SUPERVISING ENGINEER'S INITIALS
 - ⑲ PRINCIPAL ENGINEER'S SIGNATURE
- * FOR CONSULTANT DESIGNS ADD FIRM NAME

The diagram illustrates the layout of a traffic control signal design form. It is divided into several key sections:

- Header Section:** Contains fields for 'ENERGY BY- MAINT LEVEL' (1, 2), 'ADDRESS # - SERVICE POLE-' (3, 4), and 'INTERSECTION#' (5, 6).
- Signal Faces Section:** A large area labeled 'SIGNAL FACES' (8) for detailing signal heads and pedestrian heads. It includes a sub-section for 'TOWN SIGNAL' (10) and a note area (11).
- Office Record Section:** A table with columns for 'STC #' and 'SM #'.
- Professional Stamp Section:** A rectangular area (12) for the State of Connecticut Department of Transportation stamp, including the text 'STATE OF CONNECTICUT DEPARTMENT OF TRANSPORTATION BUR. OF ENGINEERING & HWY OPERATIONS DIVISION OF TRAFFIC ENGINEERING TRAFFIC CONTROL SIGNAL'.
- Revision and Signature Section:** A table (14) for tracking revisions, with columns for 'REV #', 'ENGINEER', 'DRAFTER', 'CHECKED BY', 'SUBMITTED BY', and 'APPROVED BY'. It also includes fields for 'TRAFFIC DATE' and 'ELECTRICAL DATE'.
- Legend Section:** A table (15) defining symbols for signal colors (R for Red, Y for Yellow, G for Green) and arrow types (RED ARROW, YELLOW ARROW, GREEN ARROW, WALK/ PED. CLR., DON'T WALK, FLASHING).
- Initials and Signature Section:** Fields for initials and signatures, including 'DRAFTER'S INITIALS' (16), 'CHECKER'S INITIALS' (17), 'SUPERVISING ENGINEER'S INITIALS' (18), and 'PRINCIPAL ENGINEER'S SIGNATURE' (19).

Figure 16-4 Design Information Blocks

<u>TRAFFIC CONTROL SIGNAL PLAN OFFICE RECORD</u>																	
<table border="1" style="width: 100%; border-collapse: collapse;"> <tr><td colspan="2" style="text-align: center;">OFFICE RECORD</td></tr> <tr><td style="width: 50%;">STC#</td><td style="width: 50%;">SM #</td></tr> <tr><td colspan="2">SIGNAL IN OPERATION</td></tr> <tr><td> </td><td> </td></tr> <tr><td> </td><td> </td></tr> </table>	OFFICE RECORD		STC#	SM #	SIGNAL IN OPERATION						<u>NEW SIGNAL</u>						
OFFICE RECORD																	
STC#	SM #																
SIGNAL IN OPERATION																	
<table border="1" style="width: 100%; border-collapse: collapse;"> <tr><td>ENGINEER</td></tr> <tr><td>DRAFTER</td></tr> <tr><td>CHECKED BY</td></tr> </table>	ENGINEER	DRAFTER	CHECKED BY	LEAVE BLANK PERMANENTLY.													
ENGINEER																	
DRAFTER																	
CHECKED BY																	
<table border="1" style="width: 100%; border-collapse: collapse;"> <tr><td colspan="2" style="text-align: center;">OFFICE RECORD</td></tr> <tr><td colspan="2" style="text-align: center;">REVISION • 6</td></tr> <tr><td style="width: 50%;">STC#</td><td style="width: 50%;">SM #</td></tr> <tr><td colspan="2">SIGNAL REVISED</td></tr> <tr><td colspan="2" style="text-align: center;">(DESCRIPTION OF REVISION)</td></tr> <tr><td> </td><td> </td></tr> <tr><td> </td><td> </td></tr> </table>	OFFICE RECORD		REVISION • 6		STC#	SM #	SIGNAL REVISED		(DESCRIPTION OF REVISION)						<u>SIGNAL REVISION</u> <u>ON</u> <u>NEW PLAN</u>		
OFFICE RECORD																	
REVISION • 6																	
STC#	SM #																
SIGNAL REVISED																	
(DESCRIPTION OF REVISION)																	
<table border="1" style="width: 100%; border-collapse: collapse;"> <tr><td>REV #</td><td style="text-align: center;">6</td></tr> <tr><td>ENGINEER</td></tr> <tr><td>DRAFTER</td></tr> <tr><td>CHECKED BY</td></tr> </table>	REV #	6	ENGINEER	DRAFTER	CHECKED BY	INSERT REVISION NUMBER WHEN "SIGNAL REVISED" DATE IS ADDED (WHEN WORK IS COMPLETED). UNTIL THEN LEAVE BLANK.											
REV #	6																
ENGINEER																	
DRAFTER																	
CHECKED BY																	
<table border="1" style="width: 100%; border-collapse: collapse;"> <tr><td colspan="2" style="text-align: center;">OFFICE RECORD</td></tr> <tr><td style="width: 50%;">STC# 156-0610-03</td><td style="width: 50%;">SM # 12345</td></tr> <tr><td colspan="2">SIGNAL IN OPERATION</td></tr> <tr><td colspan="2" style="text-align: center;">REVISION • 1</td></tr> <tr><td style="width: 50%;">STC#</td><td style="width: 50%;">SM #</td></tr> <tr><td>TRAFFIC DESIGN</td><td>ELECT. DESIGN</td></tr> <tr><td colspan="2">SIGNAL REVISED</td></tr> <tr><td colspan="2" style="text-align: center;">(DESCRIPTION OF REVISION)</td></tr> </table>	OFFICE RECORD		STC# 156-0610-03	SM # 12345	SIGNAL IN OPERATION		REVISION • 1		STC#	SM #	TRAFFIC DESIGN	ELECT. DESIGN	SIGNAL REVISED		(DESCRIPTION OF REVISION)		<u>SIGNAL REVISION</u> <u>ON</u> <u>EXISTING PLAN</u>
OFFICE RECORD																	
STC# 156-0610-03	SM # 12345																
SIGNAL IN OPERATION																	
REVISION • 1																	
STC#	SM #																
TRAFFIC DESIGN	ELECT. DESIGN																
SIGNAL REVISED																	
(DESCRIPTION OF REVISION)																	
<table border="1" style="width: 100%; border-collapse: collapse;"> <tr><td>REV #</td></tr> <tr><td>ENGINEER</td></tr> <tr><td>DRAFTER</td></tr> <tr><td>CHECKED BY</td></tr> </table>	REV #	ENGINEER	DRAFTER	CHECKED BY	DO NOT CHANGE REVISION NUMBER (IF ANY).												
REV #																	
ENGINEER																	
DRAFTER																	
CHECKED BY																	

Figure 16-5 Traffic Control Signal Plan Office Record

- ① CONSTRUCTION NOTES (SEE DOT WEBSITE OR FIGURE 21-1 FOR COMMONLY USED NOTES)
- ② LEAVE NUMBER BLANK UNLESS CONSTRUCTION NOTES ARE PART OF PERMANENT RECORD
- ③ INTERSECTION NUMBER
- ④ REVISION BLOCK FOR CONSTRUCTION CHANGE ORDER

CONSTRUCTION NOTES

①

④

REV #

INTERSECTION #

②

③

REVISIONS				CONNECTICUT DEPARTMENT OF TRANSPORTATION			
NO.	DATE	INIT.	DESCRIPTION	PROJECT NO.	DRAWING NO.	TOWN	SHEET NO.







Figure 16-6 Construction Notes Section

- ① SIGN LEGEND AND NOTES IF APPLICABLE
- ② NORTH ARROW SHOULD BE IN THE TOP RIGHT CORNER AND POINT TOWARD THE TOP OR THE RIGHT
- ③ REVISION NUMBER (THIS NUMBER SHOULD MATCH THE LATEST NUMBER SHOWN IN THE OFFICE RECORD PORTION OF THE PLAN)
- ④ INTERSECTION NUMBER
- ⑤ SPAN POLE OR MAST ARM INFORMATION AS APPLICABLE
- ⑥ DIRECTORY / FILE NAME
- ⑦ CLOSED LOOP DETECTOR BLOCK (IF APPLICABLE)
- ⑧ DUAL RING DIAGRAM (IF APPLICABLE)
- ⑨ TOWN NAME AND INTERSECTION DESCRIPTION
- ⑩ RAILROAD PRE-EMPTION TRACK CIRCUIT TIMING BLOCK (IF APPLICABLE)
- ⑪ 1" 40' (1:500)
- ⑫ IF IT WILL BE A TOWN SIGNAL THEN ADD HERE

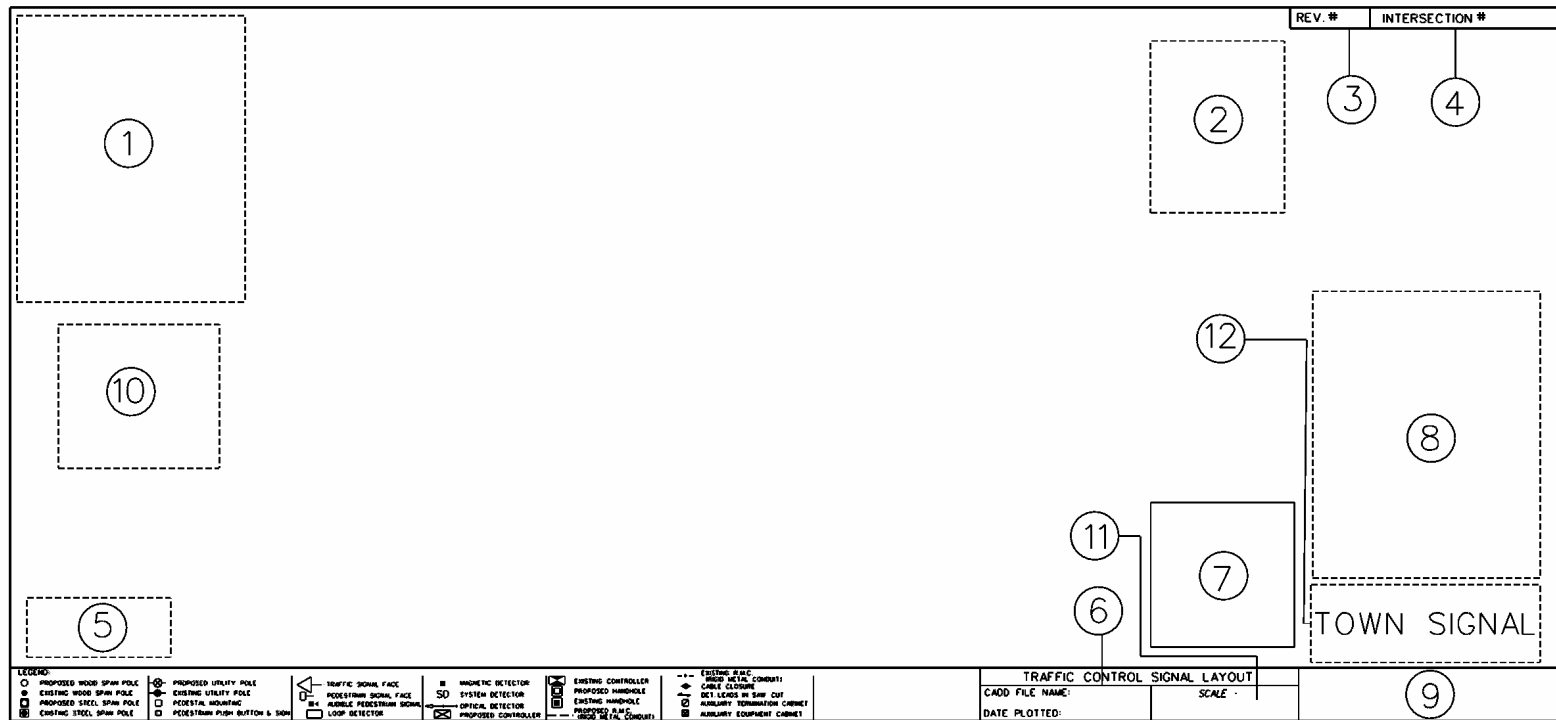

Figure 16-7 Intersection Layout

17 SIGNAL SYSTEMS

Signal systems should be designed to move platoons of traffic on arterial roadways and/or for queue control. Emphasis should be placed on the development of a wide "green band" to favor the flow of the arterial street traffic while not restricting the flow of other traffic. Sometimes the volume of traffic entering or leaving the system from side streets may exceed the through volume on the arterial. Every effort should be made to define the origin and destination of traffic in the system and to be sure that the major flows are incorporated into the progression.

Signal System Coordination Types

A **closed loop** system is a method of coordinating several signalized intersections with a master. The master is interconnected to and communicates periodically with each local controller (usually transmitting the correct time of day). The master also communicates with a central office computer. Once the system timing plan is initially programmed and stored in the local controllers the master serves as a communication hub between the central office and the locals. When necessary, for example due to an incident or an extreme weather condition, the on-street master receives coordination instructions from an operator at the central office and in turn downloads the information to the local controllers. The master also receives pertinent information from the local controllers and transmits that to the central office. An operator, at the central office, has the ability to revise the system timing plan, monitor the status of each local controller, extract vehicle volume and occupancy data, pre-emption history, malfunction history, and even change local controller phase timing.

A **time base** system is a method of coordination in which the system timing plan is typically programmed in an external device known as a time clock/time base coordinator (TC/TBC). This device is located in each controller cabinet. The system timing plan may also be programmed directly into the local controller. There is no interconnect or communication between intersections or to a central office. The time base electronic clock is very accurate and once programmed, supplies the coordination information such as system cycle length, offset, yield point, max 2 selection, permissive period, etc.

An **open loop** system is a method of coordinating several signalized intersections with a master. As with a closed loop system, the master serves as a hub and communicates periodically with the local intersections. The system timing plan resides in the local controllers. The master also receives pertinent information from the local controllers. In an open loop system however, there is no communication with a central office computer. The system timing plan is either manually programmed or downloaded from a laptop computer into the master. To revise the system parameters or extract data from the local controllers the operator must go to the master and connect a laptop. This type of system is seldom used by the Department.

The closed loop and the open loop systems have the ability to operate in a traffic responsive mode, which is defined in the Glossary. The Department has determined that a traffic responsive operation does not improve system efficiency more than a well designed time-of-day (TOD) operation, and in fact may be detrimental to the system concept. A traffic responsive operation requires considerable effort to design, monitor and support. All system detection must be accurate and impeccably maintained. A malfunctioning detector or a disabled vehicle on a detector may cause the master to transition to an undesirable pattern. In addition, the master may transition back and forth unnecessarily between two timing patterns if the arterial volumes fluctuate between critical threshold volumes. A transition period is usually 15 minutes. All systems in use by the Department currently operate in a TOD mode. The pattern settings and the time of day that the patterns change is pre-determined by a traffic engineer. Once programmed, the pattern in use is selected depending on the time of day and the day of week.

Procedure for Determining System Type

The procedure for determining the type of coordination for a new signal system or a revision to an existing signal system is a five stage process aimed at providing a signal system that is efficient and expandable as well as consistent with the Department's Congestion Management System. This procedure is not generally necessary for the addition of new signals within the confines of an existing system but may be necessary for new signals proposed at the end of an existing system.

Traffic Engineering Analysis

1. Define area to be controlled and determine current and long-term needs, keeping in mind proposed new roadway facilities and possible future signal locations and future signal systems.
2. Determine if area to be controlled has been established as an alternate route or has the potential to be an alternate route. An alternate route is a route established by the Department to be used by motorists in the event of an incident on a freeway. The list of official alternate routes for Connecticut is maintained by the Highway Operations Section of the Office of Maintenance.
3. Determine the following transportation characteristics of the area:
 - a) Arterial volume to capacity ratio (V/C).
 - b) Route characteristics:
 - major commuter route
 - major commercial area
 - major recreational area
 - c) Number of traffic peaks and directional flow.
 - d) Frequency of special events.

Systems Analysis

1. Define system parameters:
 - a) Number of intersections controlled.
 - b) Number of timing plans using computer programs such as Synchro, Passer II, Transyt-7 or other techniques.
 - c) Number of system sections - determine if the defined system should be broken down into sub-systems.

2. Define methods of controlling system timing:
 - a) Time of day.
 - b) Manual - (manual override) ability to implement special system timing plans from a remote site.

Selection of Alternative Systems

1. Initial Screening: If the proposed system limits lie within an alternate route, select a closed loop system, disregard the signal system work sheet and proceed to the approval stage.

2. Signal System Work Sheet:
 - a) Fill out the signal system work sheet.
 - b) Select the system whose point total corresponds with the range of total points indicated below:

<u>Type of System</u>	<u>Point Range</u>
Time base coordination	5 - 14
Closed Loop System	15 - 23

Obtain Input from the Highway Operations Section of the Office of Maintenance

Upon completion of the work sheet, the originating unit shall send a Signal System Concurrence Sheet to the Office of Highway Operations indicating the Division of Traffic Engineering's preliminary recommendation regarding the type of system and requesting that office's review and comment. Accompanying the concurrence sheet should be a section of road map indicating the limits of the system and the individual signalized intersections, a completed signal system work sheet and any other supporting data that may be appropriate.

Obtain Approval of the Selected Type of Signal System

Upon the return of the Signal System Concurrence Sheet from the Office of Highway Operations and consideration of any comments, the originating unit shall forward the final recommendation for the type of signal system and all supporting information to the Manager of Traffic Engineering for approval.

Signal Coordination System Selection Work Sheet

Parameter	Weighted Measure			Parameter Point Total
	1	2	3	
Number of System Sections	1	2 - 4	Greater than 5	
Number of Timing Plans	3 or less	4 - 6	Greater than 6	
Alternate Route Potential	No Potential	Slight Potential	Great Potential	
Method of Controlling Signal Timing	Time of Day	Time of Day and Manual		
Arterial V/C Ratio	.50 to .70	.71 to .80	> .80	
Parameter	Weighted Measure			
	0	3		
Route Characteristics	All Other Roadways	Major Commuter Route Major Commercial Area Major Recreational Area		
Need for Surveillance	Not Needed	Needed for Monitoring and Data Collection		
Number of Intersections	2 – 20	Greater than 20		
			TOTAL	

Type of System Point Range
Time base Coordination 5 - 14
Closed Loop System 15 – 23

Figure 17-1 Signal Coordination System Selection Work Sheet

Signal System Concurrence Sheet

L O C A T I O N S	<p>TOWN: _____ ROUTE: _____</p> <p>DESCRIPTION:</p>
T R A F F I C	<p>TRAFFIC ENGINEER: _____ DATE: _____</p> <p>WARRANT SHEET ATTACHED: YES: _____ NO: _____</p> <p>MAP ATTACHED: YES: _____ NO: _____</p> <p>SUPPORTING DATA ATTACHED: YES: _____ NO: _____</p> <p>COMMENTS:</p> <p>TYPE OF SYSTEM RECOMMENDED:</p> <p>PRINCIPAL ENGINEER:</p>
O P E R A T I O N S	<p>SYSTEMS ENGINEER: _____ DATE: _____</p> <p>COMMENTS:</p> <p>CONCUR WITH RECOMMENDED SYSTEM: YES: _____ NO: _____</p> <p>PRINCIPAL ENGINEER:</p>
A P P R O V A L	<p>APPROVED AS RECOMMENDED</p> <p>YES: _____ NO: _____</p> <p style="text-align: center;">MANAGER OF TRAFFIC ENGINEERING</p> <p style="text-align: center;">_____</p>

Return to Unit _____

Figure 17-2 Signal System Concurrence Sheet

Signal System Design

Arterial control is concerned with controlling signals along an arterial highway so as to give major consideration to progressive flow of traffic along that arterial. It is desirable to develop a time relationship between the master location and each intersection along the artery. The green should be displayed at an intersection sufficiently in advance of the arrival of a major platoon, to clear vehicles that may be stopped and to allow the platoon to continue without stopping.

When developing a timing plan, it is preferable to have vehicles arrive at each intersection too early rather than too late. Vehicles arriving a little bit early wait a lot less time than vehicles arriving late. Early arrivals can avoid stopping by adjusting their speed. Vehicles that are a bit late are tempted to run the yellow light or increase their speed.

The timing plan of a system consists of three elements: splits, offsets and system cycle lengths. The splits must be determined for each individual intersection in the system and may vary from intersection to intersection. The split is the segment of the intersection cycle length allocated to each phase that may occur. The offset is defined as the time difference from the reference line of the system to the beginning of the artery yellow interval at each intersection. The reference line is usually chosen as the beginning of the artery yellow interval at the master. Determination of an optimum system cycle length(s) is the key to any efficient signal system. The intersection cycle length(s) for each signal in a system must be the same or a multiple of one another. Methods for determining optimum intersection cycle length and phasing were discussed earlier.

The engineer should consider progression before finalizing the phasing for the individual signalized intersections when designing signals that are going to be included in a signal system. It is important to have safe and efficient operation at each intersection but there are design options that should be considered. In lieu of quad left-turn phasing for protected left-turns on the artery, the designer may find that a lead-lag design would provide better progression and still provide a safe and efficient operation. Therefore, after determining the lane arrangements, signal phasing, cycle length and the number of timing patterns for each intersection, the designer should perform a preliminary arterial analysis including a time-space diagram.

There are many computer programs available to assist in arterial progression analysis. The designer should explore system cycle lengths that are compatible with the optimum intersection cycle lengths. A review of this information should indicate if any changes to the phasing are appropriate for improved arterial operation. This process is important because signal phasing for the individual intersections can limit the ability to provide good progression through the system.

Another factor in the design of an individual intersection that may become evident during the arterial analysis is that some intersection cycle lengths may not be compatible with the system cycle length during some timing plans. These intersections should be designed to have flexibility to operate full-actuated during these time periods. The same consideration should be given to signals that do not have programmed flash when most of the other signals in the system flash during nighttime hours. Therefore, this process is important because it may show the need to revise signal phasing and/or the type of signalization (full vs. semi-actuated) to reduce delay and improve traffic flow along the corridor.

A system may be designed to favor directional flow during peak hours. This may require a reduction in the flow in the opposite direction. The determination of level of service (LOS) and associated measure of effectiveness, as discussed in Chapter 16 of The Highway Capacity Manual, may be used to evaluate different system alternatives.

Intersections that are disruptive to the progression of the platoon may be put on flash when their operation is not essential or may run free. Left-turns from shared lanes may obstruct the flow of the platoon. Corrective actions such as turn bays or special phasing should be considered. Normally it is desirable to reserve 50 % or more of the cycle length for the artery green.

In a dual ring sequence, phase 2 is typically assigned to the artery movement in one direction and phase 6 to the artery movement in the opposite direction. In order to standardize the phasing of signals in a system the designer should assign the northbound or eastbound artery movement to phase 6 and the southbound or westbound artery movement to phase 2.

Another function that systems have is the ability to set different permissive period settings for each timing pattern. This function allows the designer to increase the permissive period during off peak hours to reduce the delay to drivers on side streets and protected left-turn phases. During normal daytime hours a 5% permissive period is typically used. At night when traffic volumes are low, the permissive period could be increased to 20% or higher. Assuming a 60 second cycle, a 20% permissive period would be 12 seconds. If a vehicle arrives within the first 11 seconds after the yield point, there would still be time to service the minimum side street time without affecting the system progression.

Time-Space Diagrams

The time relationship between intersections in an arterial system can be shown graphically by developing a **time-space diagram**. The time-space diagram is a technique for evaluating a proposed timing pattern and determining intersection offsets from a common reference point. The first step in developing a time-space diagram is to gather data, such as intersection spacing, traffic volumes (including turning movements), traffic flow variations and speed limits. Once the data has been obtained, the following steps are taken:

1. Analyze the traffic flow variations by direction on the artery, and determine the probable number of timing patterns required.
2. Using Synchro or HCS traffic software, input the applicable data and configure the lane arrangements, timings and cycle lengths to obtain an acceptable LOS. This should be done for each of the timing patterns to be developed. Once this is done, create a time-space diagram for each timing pattern.
3. Conduct a graphical analysis to determine offsets for each of the desired timing patterns as follows:
4. Plot a reference signal band for the left most signal in the system.
 - Draw a progression speed line beginning at the start of the artery green interval at the left most signal. The slope of the speed line will represent the desired progression speed (posted speed or less, expressed in feet per second (m/sec)).
 - Draw a horizontal reference line, preferably through the beginning of the artery yellow interval of the signal that will be the master location.

- Manipulate the signal bands i.e. offsets for all the signals as required, to obtain an equal bandwidth for each direction of flow.
- The results of the preceding step will provide a timing pattern with a comparable green band in both directions commonly used during off-peak times. If one direction should be favored as an AM peak or PM peak, another pattern should be created. The offsets are adjusted to provide a wider green band for that direction. Progression in the opposite direction may be compromised however.

Traffic entering the arterial system from side streets may be accounted for in the time-space diagram as part of the through band or have its own separate band. The volume of traffic included in progressive flow of traffic that may enter from side streets should be determined and accounted for in the evaluation of various signal designs. All too frequently the "fine tuning" of a system in the field involves the neglect of this traffic during design.

A signal system that cannot be made to work on paper will not work in the field. Fine tuning in the field to solve progression problems is a hectic and confusing experience. Fine tuning is exactly that...fine tuning. It should consist of minor timing revisions and not wholesale changes in operation.

For signals in a coordinated system, a time/space relationship should be demonstrated by whatever techniques are in use at the time, including computer programs.

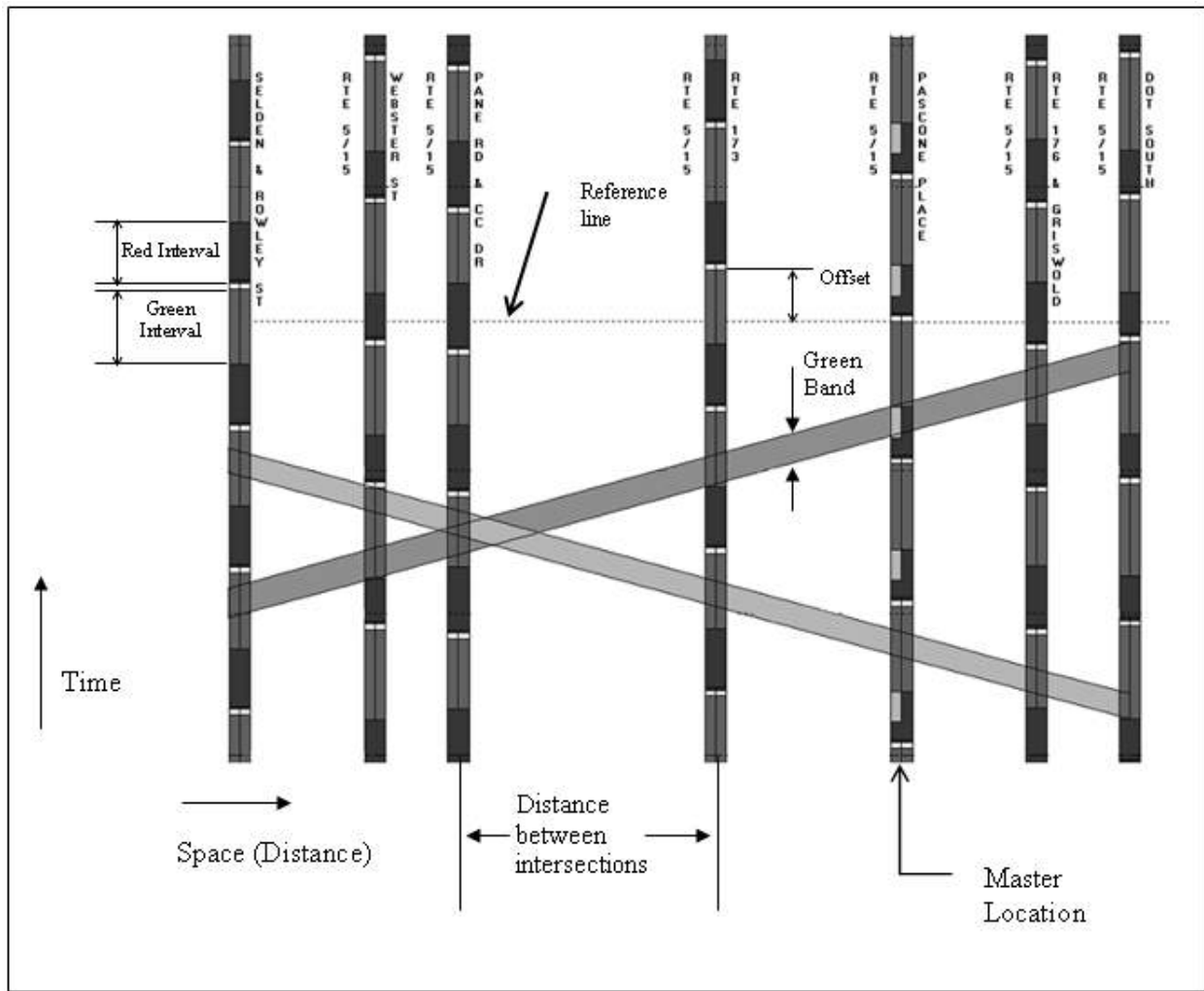

Figure 17-3 Time Space Diagram Example

Closed Loop System Design

All State owned closed loop coordination equipment must comply with the applicable sections of the current edition of the DOT Functional Specifications for Traffic Control Equipment. It is recommended that the designer become familiar with these specifications which describe the minimum system parameters. The following operational information and guidelines apply to systems purchased under the specifications in effect as of the publication date of this manual. Because of the continual advances in technology and software upgrades, earlier (and future) DOT systems may operate in a slightly different manner. If there is any question regarding the operation of a particular system, or the features available, the designer should request advice from the signal lab. The design of a municipal system should comply with municipal specifications therefore the following information and guidelines may not apply.

When signals are under closed loop control the max settings in the local controllers are inhibited. By inhibiting the max timing for phases in the local controllers, the engineer can develop splits for the system to assign different max timings for each phase for each timing pattern. The designer can use the max 1 and max 2 settings for times when the signal is running under programmed free operation. Usually the designer would only run full-actuated signals under free operation. Under free operation the system only monitors the local signal controller's operation and all the timings come from the settings on the local signal controller.

The following is provided to clarify what type of operation results when there is either a communication or coordination failure in closed loop systems. This can help the engineer better understand and assess complaints regarding signal operation. If there is a communication failure such as a break in interconnect between master and local, the signals time the programmed splits and offsets but with no communication. In the case of a coordination failure such as a prolonged period of double cycling, signals default to max 1 timings (free operation). The designer should ensure that this is considered in determining the max 1 green time settings for all signal phases.

One feature that closed loop systems have, in a sequential operation, is the ability to allocate **unused time** from a non-artery phase to subsequent phases via the Unused Time Feature (UTF). The UTF can be used for a sequential operation where there is a quad operation in the other side of the barrier in use. If the use of this feature is being contemplated in a sequence other than sequential, please check with the signal lab for compatibility. The designer can allow the time to be allocated to subsequent phases of operation or allocate to the artery phase all unused time from the non-artery phases. If this option is selected it will be shown as a technical note stating: "UNUSED TIME TO BE REALLOCATED". Utilizing this feature can be beneficial in many cases but it should be pointed out that this feature doesn't allow selection of the phase(s) to which the unused time is distributed. An example would be where there may be two side street phases, each side street having its own phase. The designer may want to consider having the low volume side street phase come in first. That way if the first side street phase is skipped or gaps out, any unused time could be used by the other side street if there are sufficient calls. Since any unused time may be allocated to following phases, the designer should avoid fixed advances. If there is a fixed advance where there are different splits for each timing plan (the advance is in max recall) all the unused time from the preceding phases would be assigned to the advance phase. It should be pointed out that the designer could have a fixed advance and still allow allocation of unused time as long as the advance only has one timing instead of different splits for each timing plan (the advance would be min recall in this case).

The allocation of unused time (UTF) gives the designer flexibility and therefore strong consideration should be given to its use. If this function is used there should be a technical note on the plan to inform anyone reviewing the signal's operation that any unused time can be allocated to subsequent phases.

In a closed loop system, cycle lengths do not always have to be increased to accommodate exclusive walk phases. If an exclusive walk phase is provided, the designer should take into account how many times an hour it is expected to be called during each timing pattern. The designer can put the full time in the data base for the walk if that phase is expected to come in frequently during the period that timing pattern is in effect.

If it is expected to come in infrequently, the designer may decide to assign a zero split for the walk phase. If the walk phase comes in, the time for the walk phase will be taken from the artery green at the start of artery green. The signal may double cycle if there isn't sufficient time in that phase to satisfy the minimum green for the artery before the yield point. This practice is not preferred because the walk takes all its time from the artery phase. The designer should add a technical note "Signal may double cycle if pedestrian timing called during patterns x, x, x" for this condition.

In instances where the exclusive pedestrian phase is expected to come in frequently, but only during a specific limited time period, the designer can consider putting the intersection in free operation for that time period. For example, a traffic signal near a school may have a pedestrian phase which is called frequently on weekdays at the beginning or end of the school day but is called infrequently other times. In this case, allowing the signal to run free during the peak pedestrian time period may be the most efficient strategy especially if that time period does not coincide with the peak traffic flow on the adjacent roadway network.

An intersection that has a full dual quad sequence along with an exclusive walk movement, known as a "9-phase" sequence, cannot be coordinated in a closed loop system. Because the walk and pedestrian clearance time is taken from a phase that is also used for a vehicle movement, the walk split cannot be assigned in the system data base. The designer may choose to allow the intersection to operate free, or if coordination is necessary, a quad/sequential sequence may be used such as Error! Reference source not found..

System Detection

When a new or an existing signal in a closed loop system is designed, the necessity and placement of system detectors (SD's) should be evaluated. If it is determined that system detection is appropriate, the designer should if possible recommend locations for SD's. The Division of Traffic Engineering will then supply this input to the Office of Highway Operations who will review and provide final recommendations.

Closed loop signal systems have the ability to accumulate, log, and process considerable information about the operation of each traffic signal in the system and when requested transmit the information to the central office in the form of a Measure of Effectiveness (MOE) report. This information may be used to fine tune intersectional and system operation. A few of the many categories are:

- Average green percentage per phase.
- Number of gap-outs per phase.
- Number of max-outs per phase.
- Number of walk phase occurrences.
- Pre-emption run occurrences.
- Vehicle counts (Volume).
- Detector occupancy percentage (Occupancy).

Volume and occupancy data are taken from vehicle detectors and is useful in determining system cycle length and phase splits. Volume data is sampled a distance from the intersection by point detection so that a series of slow moving vehicles do not count as one. Arterial (dilemma zone) loops may also serve as counting detectors. When segmented loops are used on a side street approach the rear segment may be connected to a separate amplifier and serve both as a phase actuation detector and as a counting detector. Because of installation costs and maintenance concerns the use of loops solely as system detectors (SD) should be judicious. Below are brief guidelines for the placement of SD's.

If not covered by phase actuation detectors as described above, consider SD's on:

- Arterials entering and leaving the system.
- Interior sections of the artery where the speed limit is different and it is anticipated the volume will fluctuate. A different cycle length may be beneficial.
- Major intersecting side streets.
- Large facility drives that contribute considerable volume to the artery such as shopping mall access, manufacturing/industrial complex, college/university.
- Interstate ramps.

SD's are not recommended on:

- Minor intersecting side streets.
- Minor driveways.
- Interior sections of the artery where it is not anticipated the volume will fluctuate.

Occupancy data is taken from the presence detection near the intersection. The local detectors used for phase actuation are used to determine occupancy percentage. Additional detection is not necessary.

The following signal system information is associated with closed loop systems:

1. The designation for various cycle lengths is pattern 1, 2, 3, etc. Pattern 1 is for AM peak and Pattern 5 is for PM peak. Patterns 8, 9 and 10 are reserved for incident management and are not addressed during design.
2. The number of timing patterns needed is to be determined through engineering analysis and indicated on the plan.
3. When coordinated, the maximum timer is inhibited so that only the Force Off command will release each phase. The artery phase will not gap out or max out. The max times shown on the plan apply only to free operation. In the case of a coordination failure such as a prolonged period of double cycling, signals default to max 1 timings (free operation). The designer should ensure that this is considered in determining the max 1 green time settings for all signal phases.
4. Closed loop systems have internal calendars; therefore, designs are done for military time. It is not necessary to designate Eastern Standard Time or Daylight Saving Time, the adjustment is made by the internal calendar.
5. On a full-actuated controller, the artery should be on Min Recall. On a semi-actuated controller, the artery should be on Max Recall.
6. When free operation is not part of the system design, list Free as "FUTURE."
7. System detectors should be numbered SD1, SD2, etc.
8. Offset settings should be in percent and seconds.
9. For locations that are full actuated, include the following technical note: "Artery phase loops to be non-actuating during coordination."
10. Hours of programmed flash, pattern times and hours of free operation should not overlap.

11. The "Unused Time to Side Street" feature may be used:
 - a. For a sequential operation where there is a quad operation in the other side of the barrier in use.
 - b. If the intersection has two sequential phases following the artery. The lighter volume side street would be the first phase to follow the artery, then the heavier volume side street. The "unused time to side street" feature would allow any unused time from the first side street to be allocated to the second side street.
 - c. If the intersection has an exclusive pedestrian phase. A zero split could be assigned to a pedestrian phase which is expected to come in infrequently. However this may cause double cycling. The designer should add a technical note "Signal may double cycle if pedestrian phase called during patterns x, x, x" for this condition.

Note: This feature should be avoided if there is a non-actuated phase, such as a fixed advance as all extra time would go to that phase.

12. Add technical notes: "Timings shown reflect free operation." "Actual phase splits to be determined by coordination program." "Phase splits shown reflect preliminary coordination data."
13. A closed loop detector chart is required and limited to sixteen detector amplifiers. Contact Highway Operations Section of the Office of Maintenance for details.
14. For new systems, preliminary coordination information (splits, offsets, cycle lengths, etc.) shall be indicated on the plan. For existing systems, the Highway Operations Section of the Office of Maintenance maintains the current coordination information and should be contacted to verify current coordination information.
15. The Highway Operations Section of the Office of Maintenance maintains a data base of the closed loop traffic signal timing information. Prior to the completion of a revision or addition of a new signal to an existing or a new closed loop signal system, the designer shall submit the following to the Highway Operations Section for approval:
 - a) Revised (or new) Excel Closed Loop Time Space Diagram Cover Sheets submitted in both electronic and paper format.
 - b) Revised (or new) Time Space Diagrams using Fortran Traffic Systems Limited TSDWIN latest version submitted in both electronic and paper format.

Time Base System Design

Time base systems operate on a background cycle with all unused green time assigned to the artery phase. During coordinated operation, the artery max times are inhibited. Therefore, the artery max times should be determined based on timing requirements during non-coordinated operation.

The following signal system information is associated with time base systems:

1. The designation for various cycle lengths is pattern 1, 2, 3, etc.
2. The number of timing patterns needed is to be determined through engineering analysis and indicated on the plan.
3. The controller defaults to the Max 1 time if Max 2 is not selected. Therefore, designate Max 1 as ALL OTHER TIMES. Use Max 2 for specific times such as PM peak.
4. The method used to yield the coordinated phase is Force Off.
5. New time clocks/time base coordinators accept 12-hour AM/PM programs or 24-hour military programs. Show military time on the plan. It is not necessary to designate Eastern Standard Time or Daylight Saving Time because the adjustment is made by the internal calendar. If the signal design requires a midnight setting, the time clock should be set at 23:59 (11:59 PM) not 00:00.
6. To avoid the possibility of double cycling during coordinated operation, the sum of the artery min time, plus all clearance intervals, plus all non-artery max times, plus any pedestrian interval should be approximately 3% less than the background cycle length.
7. On a full-actuated controller, the artery should be on Min Recall. On a semi-actuated controller, the artery should be on Max Recall.
8. When free operation is not part of the system design, list Free as "FUTURE."
9. On the time-space diagram, the reference line should correspond with the beginning of the artery yellow (yield point) of the master location. The yield point at all other locations in the system will offset from there.
10. Do not use zero as an offset. Some manufacturers TC/TBC interpret a zero as no number having been entered. If the system design requires a zero setting, such as at the master, the TC/TBC should be set at one and all other offsets adjusted accordingly.
11. For locations that are full actuated, include the following technical note: "Artery phase loops to be non-actuating during coordination."
12. Hours of programmed flash, pattern times and hours of free operation should not overlap.
13. Adjustable permissive periods are available.

18 SIGNAL OWNERSHIP AND MAINTENANCE

It is the policy of the Department to participate in the construction cost, ownership, maintenance and electrical energy cost of traffic control signals involving the State Highway System. As with all items requiring State Traffic Commission approval, the Local Traffic Authority should be contacted and participate in the decision process. Refer to Policy No. E & H.O. - 16 dated June 4, 2008.

Ownership and Maintenance

1. The State usually retains ownership of traffic control signals when one or more of the approach roadways are a part of the State highway system.
2. Ownership of a signal may be transferred to a municipality under certain conditions:
 - a) the Local Traffic Authority (LTA) accepts responsibility for ownership;
 - b) the State reserves the right to reassume ownership of the signal; and
 - c) the signal is in good working condition prior to the transfer and conforms to the Manual on Uniform Traffic Control Devices (MUTCD).
3. Normally, signals in a coordinated system will be owned by one jurisdiction.
4. If requested by a municipality, the Department may assume ownership of a traffic signal if the following conditions are met:
 - a) the signal is on a State highway;
 - b) the signal is warranted; and
 - c) the signal is in good operating order and the equipment meets the following Department requirements:
 - (1) the installation meets the criteria of the current MUTCD;
 - (2) the traffic control equipment, including detectors, is operating in accordance with the State Traffic Commission (STC) approved plans, sequence and timing;
 - (3) the Department has interchangeable equipment for maintenance purposes and spare parts are readily available from the manufacturer;
 - (4) a complete set of cabinet prints and plans are in the controller cabinet; and
 - (5) one set of reproducible timing, sequence, signing and marking plans are provided.

5. Normally, maintenance responsibilities for signals will coincide with ownership.
6. When the need for a State signal is to service one or more major traffic generators, the owner of the first major traffic generator requiring signalization will be expected to assume the extraordinary maintenance responsibility. Extraordinary maintenance responsibility is considered to be major component replacement, repair, or damage due to accidents, vandalism, or acts of nature and replacement due to normal wear. When maintenance and/or repair costs exceed \$500, the Department of Transportation performs the work and bills the owner of the responsible major traffic generator for all actual costs. Ordinary maintenance responsibility consists of minor electrical repairs and/or maintenance activity costing \$500 or less. When previous agreements did not establish the maintenance responsibility, the first subsequent major traffic generator which requires significant revision to the signalization will be expected to assume the extraordinary maintenance responsibility.
7. The maintenance of material or equipment, which is deemed not essential for the intersection by the State (e.g., emergency pre-emption and other special features), will be the responsibility of the town.

Installation Costs of Warranted Signals

1. Project Funded Signals:
 - a) The State will participate in the installation costs in accordance with the participation ratio established for the highway, bridge or traffic signal project.
 - b) For traffic signal projects, the State and municipality may equitably participate in the non-federal share of the estimated installation cost, if there is a town road serviced by the traffic signal. Municipal participation will not be sought if the exclusive purpose of the traffic signal improvement is an equipment upgrade.
 - c) The State will not participate in the installation costs of:
 - (1) unwarranted signals; or
 - (2) those determined the responsibility of others by Statute or circumstance.
 - d) When installing railroad pre-emption, the State will participate to the extent established for the project itself.

- e) The State will permit municipally-owned and maintained emergency equipment to pre-empt State-maintained traffic signals wherever practicable. The maintenance of the emergency pre-emption equipment will be the responsibility of the municipality. Federal and/or State funds may be used for the installation costs for needed traffic signal hardware for primary fire runs and initially for equipment needed in major fire apparatus if such funding is available.
 - f) State funds will not be used to provide material or equipment considered related but not essential to the operation of the traffic signal systems. For items such as, but not limited to, excessive interconnect capability, confirmation lights for optical or sonic pre-emption, or other special enhancements, any non-federal share must be paid by the municipality. The State may elect to participate in emergency pre-emption costs in those instances where there is an overriding State interest.
 - g) State or federal funds will not be used to provide material or equipment considered unrelated to the operation of the traffic signal systems. Items intended for other uses, such as, but not limited to, communications capacity beyond the needs of a traffic signal system, computers for pre-emption activity recording, CADD stations, or similar equipment will be nonparticipating.
2. Non-Project Funded and Non-Encroachment Permit Signals:
- a) The State will assume costs for the traffic control signal installation at intersections where all approach roadways are State highways.
 - b) The State will participate in the estimated installation costs at intersections of both State and town roads in proportion to the number of State roadway approaches.
 - c) The State will not participate in the installation costs of:
 - (1) unwarranted signals;
 - (2) those determined the responsibility of others by Statute or circumstances; or
 - (3) emergency access signals, e.g., firehouse signals.
 - d) When installing railroad pre-emption with a new signal, cost-sharing will be the same as the cost-sharing for the signal itself.
 - e) The inclusion of certain traffic control signal features deemed not essential for the intersection by the Department will be paid for by others. Municipalities may be responsible for the maintenance of such features.
 - f) Intersectional flashing beacons on State highways at intersections with municipal or State roadways will be paid for by the State.
 - g) The State may participate in the cost of signal revisions (considered major in nature) requested by a municipality as described in Item 2 b. above.

Electrical Energy Costs

1. When all approach roadways are State-owned, the State will pay for the electricity to operate the signal.
2. When one or more of the approach roadways is a town road, the municipality will be expected to pay for the electricity to operate the signal, except when the need for the signal is to serve a major traffic generator.
3. When the need for the State signal is to service one or more major traffic generators, the owner of the first major traffic generator requiring signalization will be expected to pay for the electricity to operate the signal. Where previous agreements did not establish this responsibility, the first subsequent major traffic generator which requires significant revision to the signalization will be expected to pay for the electricity to operate the signal.

Minor traffic generators, signalized as an incidental need for signal operation, will not be expected to pay for the electricity to operate the signal.

4. Normally, the State will pay for the electricity to operate intersectional flashing beacons located on the State highway system.

Where previous agreements have been made that differ from the above, those agreements will be honored. Whenever significant changes are made to the traffic control signal with such agreement, revisions to ownership and electrical energy cost arrangements to agree with the above should be considered.

A record of responsibilities (ownership, construction costs, maintenance and electrical energy costs) and changes in responsibilities, will be maintained through reports to the State Traffic Commission.

19 SIGNAL DESIGN CHECK LIST

General

1. Complete title block. For consultant designed signals, the engineering firm's name should be used.
2. R.O.W. should be shown on plan. On signal plans included in a State signal project, add the following under Construction Notes: "State Forces to Stake all R.O.W. prior to excavation." Even if all appurtenances are on state property, if a property owner may have some interest in the location of the appurtenance (ex. span pole in a residential area) the owner should be contacted during the design stage, as a courtesy.
3. North arrow should be shown according to standard convention, i.e. up or to the right.
4. State route numbers must be shown on plans and in the title block. Alternate street names are to be in parenthesis.
5. Town owned signals should be noted as such.
6. Show proposed and existing utility poles and pole numbers.
7. Make sure all symbols for traffic signal appurtenances are correct.
8. All appurtenances should be no closer than 10 feet (3 m) from utility poles.
9. Four way signal assemblies should not have more than two 5-section signals, preferably back-to-back. Five section, dog-house type signals cannot be 90 degrees to each other when mounted on the same assembly.
10. Steel poles, controllers, pedestals, loops, etc. should have station numbers or be tied down off fixed objects, not pavement markings.
11. Loops are to be dimensioned laterally off curb or by construction note. Tie down front edge of loop by station or fixed object. Loops should be identified per phase, per lane.
12. All signal equipment should be located in the State/Town right-of-way unless an easement has been obtained.
13. Confirm easements are secured where required. Verify easements have been recorded on town land records. Show easement on the plan with the file number. For consultant designed signals, confirm that the CE will secure easements where required.
14. If the signal design includes the removal of existing equipment located on private property (without the benefit of an easement), a "Right to Remove" agreement should be pursued with the Office of Right of Way.

15. If the signal design utilizes a utility pole and the installation of a guy on private property is required, an easement should be pursued by the designer. See Chapter 15 (Use of Utility Poles), for additional discussion of guys and possible alternatives.
16. Steel pole/mast arm foundations should not conflict with proposed or existing underground utilities.
17. Steel pole/mast arm assemblies should have sufficient horizontal and vertical clearance from proposed or existing overhead utility lines.
18. Steel poles should have sufficient height to provide at least 16 feet (4.8 m) clearance for the lowest traffic signal and be located outside the clear zone. See Clear Zone guidelines in **Figure 20-1**. See the Highway Design Guidelines for horizontal curve correction factors and additional information on clear zones.
19. Verify that cable is sufficient. Cable closure should be curb side, approximately 5 feet (1.5 m) from the curb, on the controller side of span.
20. Conduit should be large enough to hold all cables not to exceed 40% of area and in accordance with the National Electrical Code.
21. Loops should provide sufficient detection area.
22. Where span and messenger is proposed to attach to utility poles, confirm adequate clearance from communication lines and secondary service.
23. Contact utility company to notify them of their involvement and get approval for attachments to utility poles. Minutes of meetings with the utility company representatives should be submitted. For consultant designed signals, this is the responsibility of the CE.
24. Where signals will be town owned and/or included in existing town interconnect systems, consult with town representatives for proper interconnect information i.e., preferred equipment, type of cable, connection to existing system. For consultant designed signals, this is the responsibility of the CE.
25. Look at overall scheme such as phasing, detector placement, interconnect, pre-emption, etc. and verify that it will work properly and in the most efficient manner. Review programmed flash operation.
26. The Division of Traffic Engineering will check with the municipality to see if they want pre-emption and, if so, what type.
27. For developer signals, the developer's name and address should be shown on the Construction Notes section of plan.
28. Complete service request forms.

29. When the use of Programmed flash is not included in the current signal operation, it should generally be noted as "FUTURE". In instances where the use of programmed flash would constitute a safety concern (sight line restriction, railroad pre-emption, etc.), it should be noted as "NONE".
30. Check cross-sections when doing pole calculations.
31. For consultant designed signals, steel span pole and mast arm calculations must be submitted by CE.
32. For consultant designed signals, the calculated inductance for each lane should be recorded on the loop detector test data chart and submitted by the CE.
33. All special provisions must be submitted in electronic format in the correct template which can be found on the DOT web site. Before submission, the Contract Checker Program should be used. This program is available on the DOT web site.
34. Check for conformance with ADA guidelines.
35. Check location of signal appurtenances for visibility to the signal indications for both drivers and pedestrians.
36. Signal face numbers and detector numbers should correspond to the appropriate phase, where possible.
37. On all state projects proprietary items must be submitted for Department approval. The request for proprietary items must originate from the town and include justification. An individual letter is required for each project.
38. The Traffic Signal Maintenance Category will be provided by the Division of Traffic Engineering.
39. Verify that the controller does not intrude into sight triangle.
40. Where applicable, following note to be added to Developer's signals on plan layout: "Property owner responsible for major component replacement."
41. The size of signal faces and pedestrian symbols are to be shown on the signal plan. The type of bulb (incandescent or LED) should also be noted.
42. Review construction notes. Notes should be used only to clarify an area of the installation that may be ambiguous to the contractor, or where specific instruction is needed.
43. On State projects where a controller is being installed within a State owned closed loop system, include a "State furnished controller" as an item in the project.

Timing and Sequence

44. Complete revision information. For consultant designed signals and for designs included in projects, a stand-alone plan is required for each revision. The description of the revision in these cases should be kept general and limited in detail, for example: “Signal revised under Project Number xxx-xxx”.
45. On revisions to a signal on the existing plan, the description of the revision should be general and brief. For example, “Revised timings”. An exception to this guideline is when the revision involves a change in the hours of programmed flash operation. In this case, the description of the revision should include both the current and revised hours of flash.
46. Complete service source, responsibility for electricity cost, etc. on the plan.
47. If existing controller is to be used, verify that it can be modified for new sequence. If it cannot, recommend new. If existing controller is used, verify phases are shown correctly.
48. Non-actuated advance will normally be in max-recall. Some closed loop systems may be different.
49. Signals with pedestrian actuated side street green should have only 1 sec. in “Don't Walk” interval. The remainder of the required pedestrian crossing time should be placed in the “Walk” interval.
50. If yellow interval is set at 0 in the controller, it will revert back to the default value of 3”. Therefore, in instances where a short yellow interval is desired (exclusive walk phase), the yellow should be 0.1”. The red interval may be set at 0”.
51. Show max times for each phase. If Max 2 is not used in the function chart, then label it for future use. If Max 2=FUTURE, then the timing shown for Max 2 should be the same as Max 1.
52. Verify that pedestrian timings are correct and are shown in the proper phase, especially where side streets have separate phases.
53. Verify that pre-emption notes are correct.
54. Verify that technical/skip notes are necessary and correct.
55. Verify that proper interconnect data is shown.

Estimates for Projects

56. Verify that quantities shown for a particular intersection match those shown on the detailed estimate sheet.
57. Complete detailed estimate sheet.
58. Verify that detailed estimate sheet matches proposal estimate.
59. Confirm all utility involvement has been identified and all estimates for reimbursable utility work have been received. The prime designer must include money in the proposal estimate for “work by utilities”. For consultant designed signals, the CE is responsible for these tasks.
60. Prime designer must include enough money in the proposal estimate for “work by State Forces” to cover anticipated costs by the Office of Maintenance.
61. Verify that items are shown correctly on proposal estimate. "A" suffixes should be used when special provisions are required.

20 CLEAR ZONE CHART

Recommended Clear Zone Distances (feet)

Design Speed	Design Year ADT	CUTS or FILLS (Negative Shelf)		CUTS or FILLS (Positive Shelf)	
		6:1 or flatter	4:1	4:1	6:1 or flatter
≤40 MPH	Under 750	7	7	7	7
	750-1500	10	12	10	10
	1500-6000	12	14	12	12
	Over 6000	14	16	14	14
45-50 MPH	Under 750	10	12	8	10
	750-1500	14	16	12	14
	1500-6000	16	20	14	16
	Over 6000	20	24	18	20
55 MPH	Under 750	12	14	10	10
	750-1500	16	20	14	16
	1500-6000	20	24	16	20
	Over 6000	22	26	20	22
60 MPH	Under 750	16	20	12	14
	750-1500	20	26	16	20
	1500-6000	26	30	18	24
	Over 6000	30	30	24	26
65-70 MPH	Under 750	18	20	14	14
	750-1500	24	28	18	20
	1500-6000	28	30	22	26
	Over 6000	30	30	26	28

Notes:

All distances are measured from the edge of the travel way.

See Connecticut Department of Transportation Highway Design Manual for application of clear zone criteria.

For clear zones, the "Design Year ADT" will be the total ADT on two-way roadways and the directional ADT on one-way roadways (e.g., interchange ramps and one roadway of a divided highway, unless noted otherwise).

The values in the table apply to all facilities both urban and rural. See Section 13-2.02 of the Connecticut Department of Transportation Highway Design Manual for utility poles in urban areas.

Figure 20-1 Recommended Clear Zone Distances

21 DRAFTING GUIDELINES FOR CONSULTANTS

All design development and drafting must use the 2007 Digital Design Environment located at www.ct.gov/dot/digitaldesign. Blank signal layouts, appropriate cell libraries and detail estimate sheets can be configured using the 2007 Digital Design Environment while typical detail sheets are available on the DOT's website. A stand-alone plan in 1 in. = 40 ft. scale is required for all revisions or new installations. This includes plans by developers. It should be noted that in some instances, the design phases noted below may be combined.

Preliminary Design Requirements

1. All required dimensioning on intersection plans shall be in feet.
2. Complete the movement diagram and sequence and timing portions of the plan. If dual ring operation is used, a phasing diagram should be included on the plan.
3. Locate signal equipment such as controllers, detectors, pedestals, poles and signal heads, including dimensions for all ties. All appurtenances are to be tied down to fixed objects or by baseline stationing. Do not show conduit, handholes or wiring requirements at this time unless revision is minor in nature.
4. If unknown, determine Town/City preferences for design elements such as emergency pre-emption, pedestrian provisions and other special design considerations.
5. Indicate type of coordination, if required, and means of establishing coordination between signals. For closed loop systems, the need for system detection should be considered.
6. Right-of-Way must be shown.
7. The signal layout is to be void of any extraneous information which includes overhead and underground utility lines, trees, shrubs, manholes (unless used for service), gas gates, water gates, fences, buildings, etc. Base lines are to be shown on new construction projects.
8. Traffic control plans including traffic signal appurtenances, as described above, may be forwarded to the Division of Traffic Engineering for review after the geometry has been finalized. The final geometry should reflect existing conditions as found in the field. New construction should reflect the final proposed geometry. Existing geometry is not to be shown with proposed geometry on signal plans.
9. North arrow to be shown on plan according to standard convention, i.e. up or to the right.
10. If pavement markings and signing are extensive, a separate 22 in. x 34 in. plan should be provided. If a separate signing and marking plan is provided, the necessary dimensions should be shown on that plan only. However, the pavement markings and any appropriate regulatory signing required for signal operation are still required on the signal plan. The

signal plan still must have a sign legend (sign number and description) for the required signing but not include the status of the sign i.e. EXISTING, INSTALL, etc. The sign status is shown only on the separate signing and marking plan. If a regulatory sign is span or mast arm mounted, that must also be noted in the sign legend on both the signal plan and pavement marking and signing plan. For example - "span mount 31-0823 (NTOR)".

Semi-final Design Requirements

1. Incorporate Preliminary Design comments or explain why comments were not incorporated.
2. Submit completed electrical design (on signal plan). Completed electrical design should include all conduits, handholes and wiring necessary. An enlargement may be used to clarify an area and to prevent the plan from getting cluttered. All interconnection requirements should also be noted. If interconnect is required, an index plan with all pertinent information may be required when the information cannot be shown adequately on the signal plan.
3. Add all pertinent construction notes on the right side of the 22 in. x 34 in. plan under the heading CONSTRUCTION NOTES. Use Division of Traffic Engineering notes where applicable. Examples of commonly used notes are shown in **Figure 21-1**. A more extensive list is available on the DOT website as a Traffic Engineering cell library in Microstation.

Final Design Requirements

1. Incorporate Semi-final Design comments or explain why comments were not incorporated.
2. The following items must be shown on the final traffic control signal plan:
 - Location of traffic signal equipment
 - Phasing diagrams
 - Special notes
 - All pertinent signing
 - Pavement markings
 - Electrical design and notes including coordination and interconnect information
 - Right-of-way including easement areas for signal appurtenances located on private property
 - Utility poles, catch basins, handholes, hydrants, sidewalks, sidewalk ramps, driveways, guide rail, etc.
 - Sequence and timing
 - Signal faces
 - Construction notes and details
 - Revision block data without the revision number. Number will be assigned when work is completed

3. Submit one mylar traffic control signal plan and five prints for non-project related designs. For DOT projects submit two mylar traffic control signal plans, one to be used as the contract drawing. No prints are required for DOT projects. One mylar plan is to be sealed by a Professional Engineer, licensed in Connecticut. (A sealed print is acceptable). For CADD generated plans, the consultant is required to submit disk(s) for all signal plans and signing/markings plans if prepared. The submitted disk(s) have the following requirements:
 - All disks must be in Microstation 3D format latest revision.
 - It is the consultant's responsibility to convert from DXF file to Microstation format. Any disk(s) submitted in any format other than Microstation will not be accepted.
 - All disks submitted by consultant must be complete, accurate and totally reflect the approved, final submission, signed mylar. Any variations or omissions in the file will necessitate the return of the disk(s) to the consultant for correction and resubmission.
4. Submit one mylar 22 in. x 34 in. pavement marking & signing plan and five prints, if required. No prints are required for DOT projects.
5. Submit one mylar 22 in. x 34 in. interconnect index plan, if applicable.

Legend Used on Signal Plans

LEGEND:		
<ul style="list-style-type: none"> ○ PROPOSED WOOD SPAN POLE ● EXISTING WOOD SPAN POLE ◻ PROPOSED STEEL SPAN POLE ◼ EXISTING STEEL SPAN POLE ■ MAGNETIC DETECTOR SD SYSTEM DETECTOR ←• OPTICAL DETECTOR ◻ PROPOSED CONTROLLER ◻ SIDEWALK RAMP ●← SONIC DETECTOR 	<ul style="list-style-type: none"> ⊗ PROPOSED UTILITY POLE ● EXISTING UTILITY POLE ◻ PEDESTAL MOUNTING ◻ PEDESTRIAN PUSH BUTTON & SIGN ◻ EXISTING CONTROLLER ◻ PROPOSED HANDHOLE ◻ EXISTING HANDHOLE --- PROPOSED R.M.C. (RIGID METAL CONDUIT) 	<ul style="list-style-type: none"> ◁ TRAFFIC SIGNAL FACE ◻ PEDESTRIAN SIGNAL FACE ◻ AUDIBLE PEDESTRIAN SIGNAL ◻ LOOP DETECTOR --- EXISTING R.M.C. (RIGID METAL CONDUIT) ◆ CABLE CLOSURE ↕ DET. LEADS IN SAW CUT ◻ AUXILIARY TERMINATION CABINET ◻ AUXILIARY EQUIPMENT CABINET — GUY WIRE

OPTIONAL LEGEND TO BE INCLUDED WHEN APPLICABLE:

- ◻ PROPOSED STEEL COMBINATION SPAN POLE
- ◼ EXISTING STEEL COMBINATION SPAN POLE
- ← MICROWAVE DETECTOR
- ⊙ PROPOSED LUMINAIRE
- ← VIDEO DETECTOR

Roadside and ROW Conventions

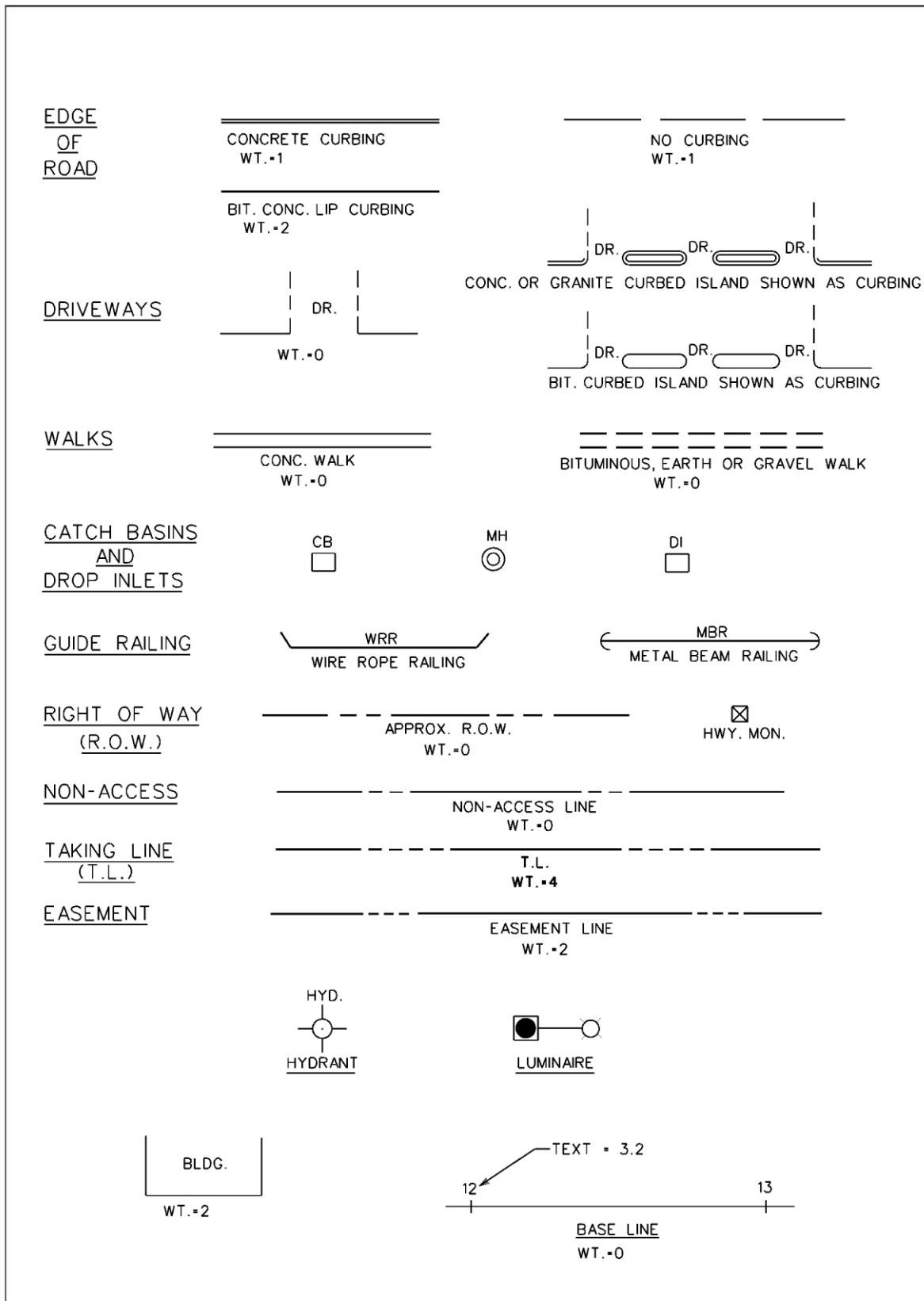

Pavement Markings

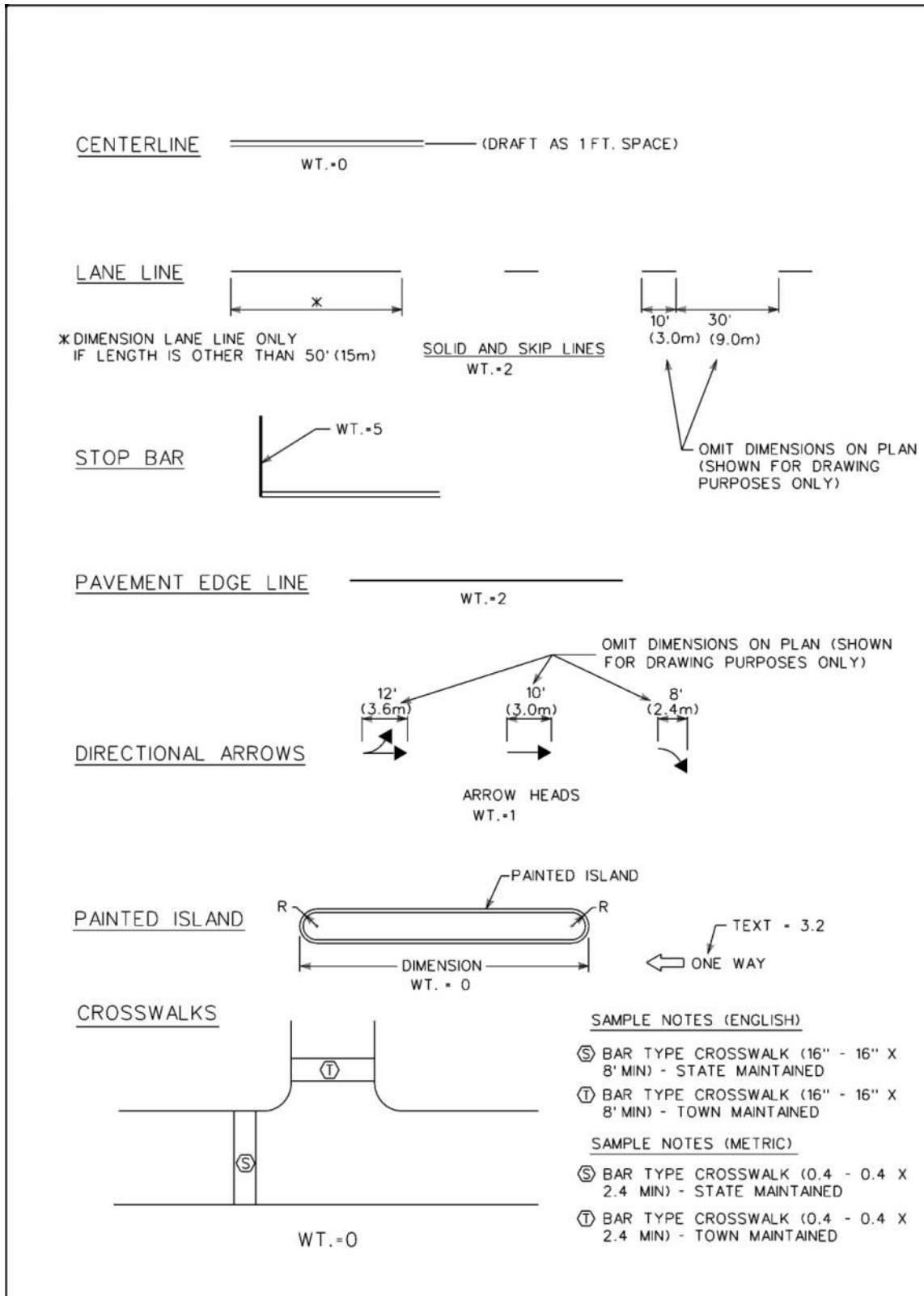

Signal Appurtenances

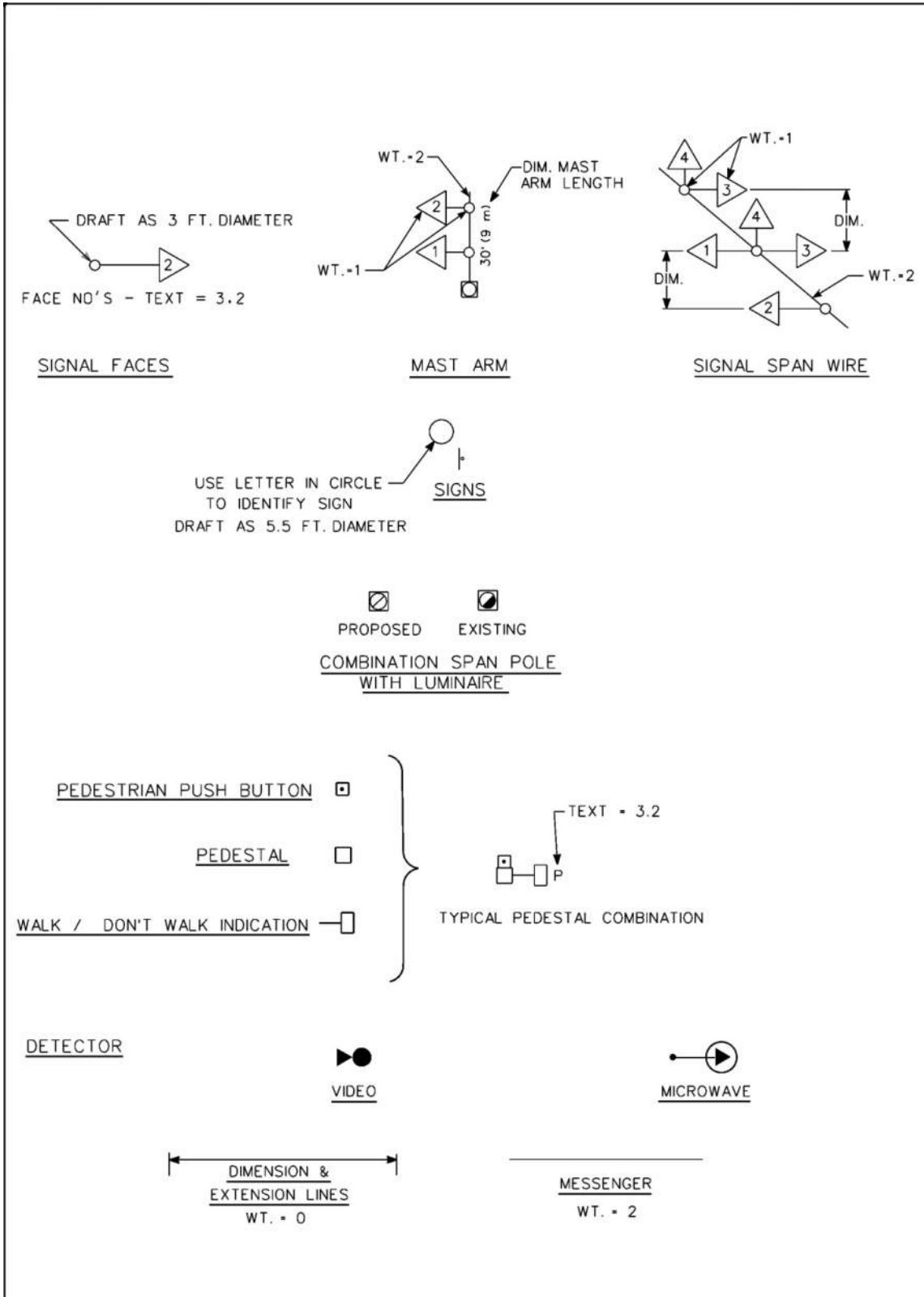

Sample Intersection Layout

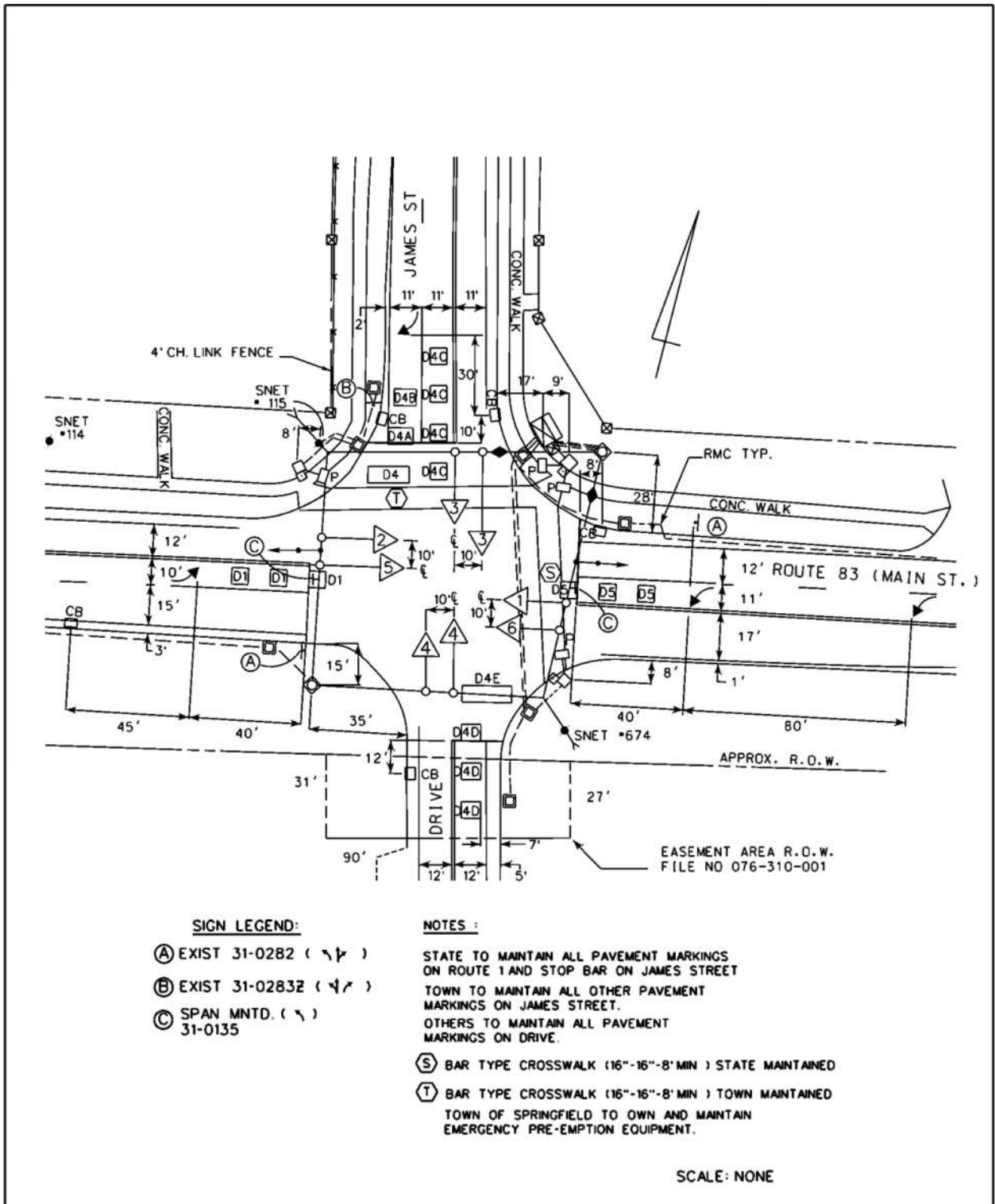

CADD Text Sizes

TEXT SIZE = 3.2	
POLE CO. & NO. C.B. & D.I. DRIVES DIMENSIONS W.R.R. & M.B.R. SIDEWALKS HYD. PAVEMENT EDGE LINE EDGE OF CONC. EDGE OF TRAVELWAY APPROX. R.O.W.	BLDGS. PROPERTY OF C SIGNS OFFICE RECORDS INITIALS & DATES NOTES ELECTRICAL SIGNAL FACES DETECTORS STATIONS (WHEN BASE LINE SHOWN)
TEXT SIZE = 4.8	
STREET NAMES ROUTE NUMBERS TITLE BLOCK SEQUENCE & TIMING CONSTRUCTION NOTES * INTERSECTION NO'S.	

* TEXT SIZE MAY BE ADJUSTED IF EXCEPTIONAL NUMBER OF NOTES

Traffic Signal Faces

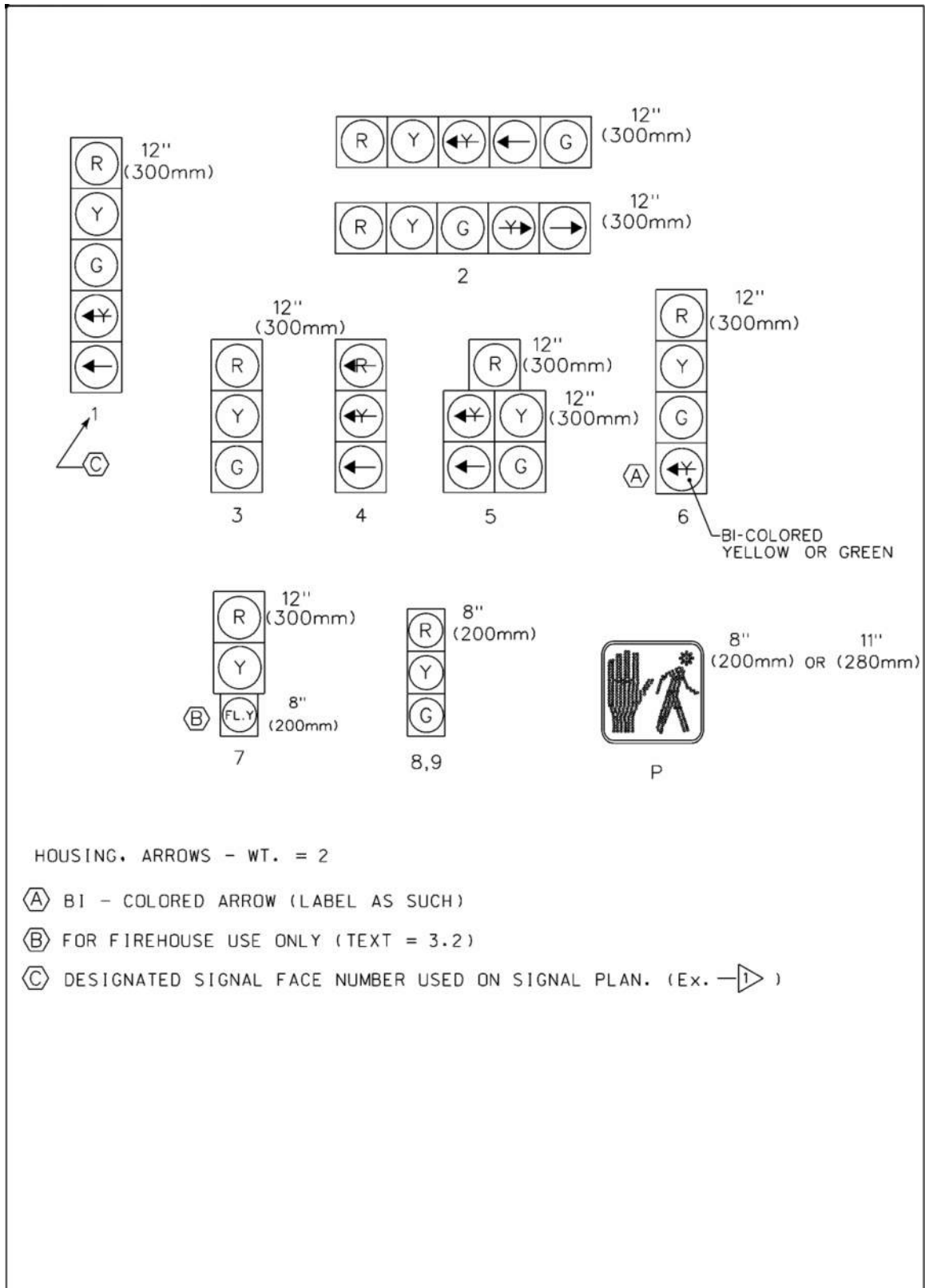

Movement Diagram

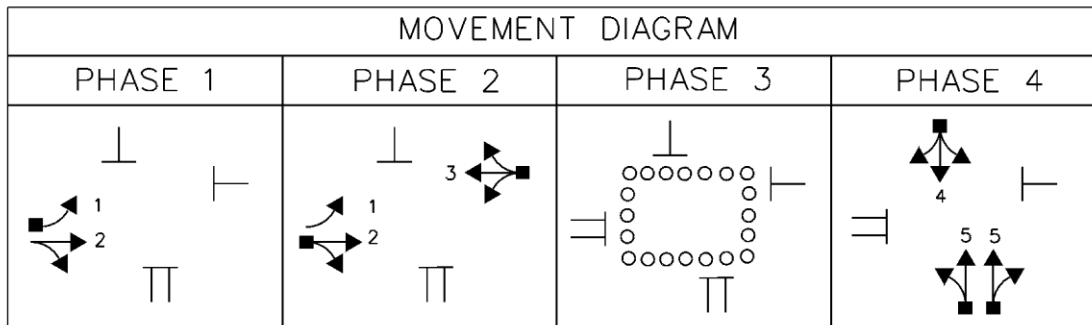

EVERYTHING WT=1 UNLESS OTHERWISE SPECIFIED

FACE NO.'S - TEXT= 3.2

ALL DETECTORS FILLED IN (SHOW ONLY WITH THE PHASE THAT IT ACTUATES.)

WALK SYMBOLS (oooo) DRAFT AS 2.5 FT. DIAMETER

MOVEMENT DIAGRAM SHOULD REFLECT THE APPROXIMATE ANGLE OF SIGNAL PLAN LAYOUT OF INTERSECTION.

Energy Block

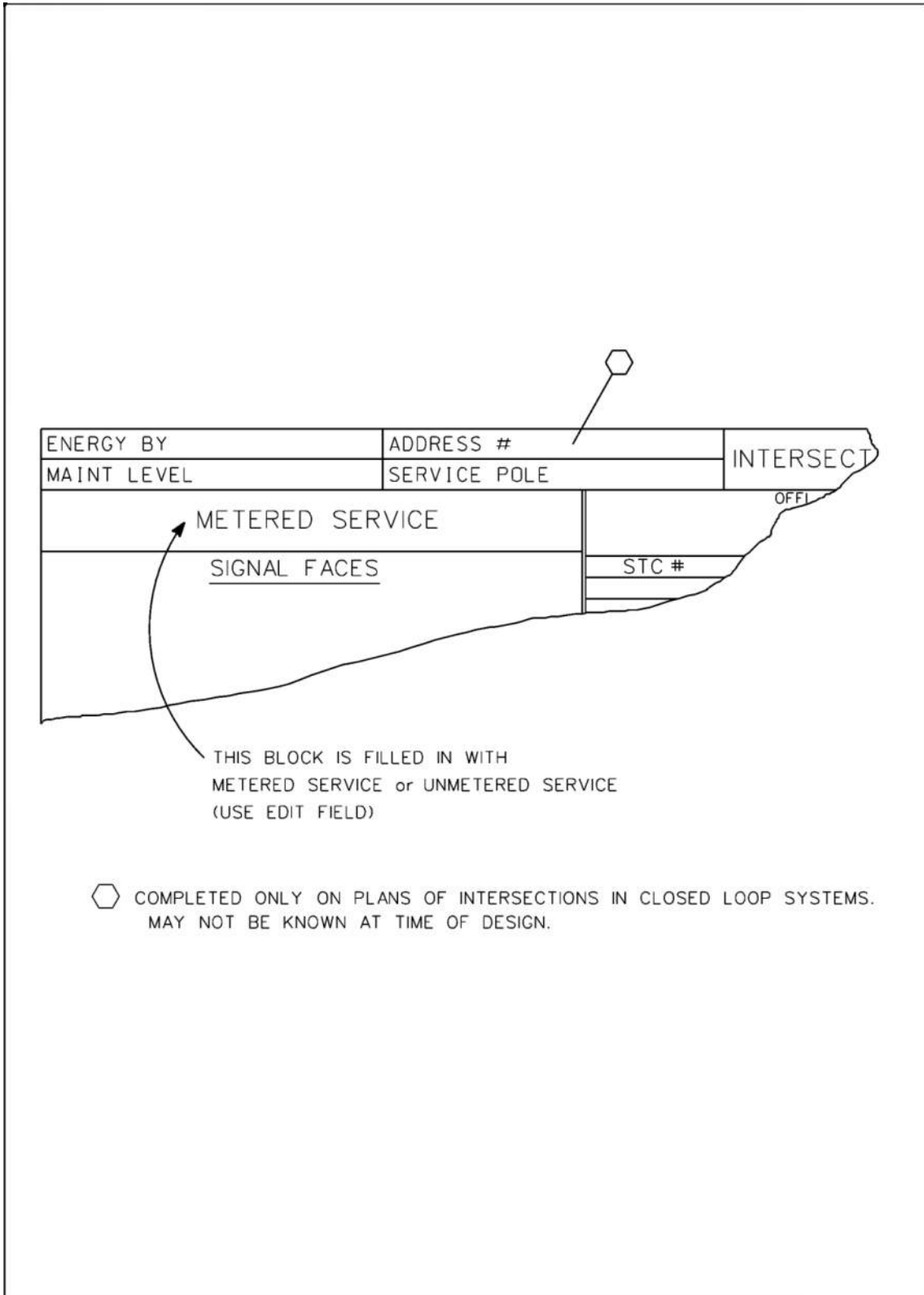

Metric Dimensional Guide

Shoulder Widths	
FEET	METERS
1	0.3
2	0.6
3	0.9
4	1.2
5	1.5
6	1.8
7	2.1
8	2.4

Lane Widths	
FEET	METERS
9	2.7
10	3.0
11	3.3
12	3.6
13	3.9
14	4.2
15	4.5
16	4.9

Loop Detectors	
FEET	METERS
6 X 6	1.8 X 1.8
7 X 6	2.1 X 1.8
8 X 6	2.4 X 1.8
9 X 6	2.7 X 1.8
10 X 6	3.0 X 1.8
11 X 6	3.3 X 1.8
12 X 6	3.6 X 1.8
13 X 6	3.9 X 1.8

Loop Detectors	
FEET	METERS
14 X 6	4.2 X 1.8
15 X 6	4.5 X 1.8
16 X 6	4.8 X 1.8
17 X 6	5.2 X 1.8
18 X 6	5.5 X 1.8
19 X 6	5.8 X 1.8
20 X 6	6.1 X 1.8

Commonly Used Construction Notes

CONNT	CELL NAME	<u>CONSTRUCTION NOTES</u>
2		ALL TRAFFIC SIGNAL EQUIPMENT IS NEW.
3		ALL TRAFFIC SIGNAL EQUIPMENT IS NEW EXCEPT AS NOTED.
4		ALL TRAFFIC SIGNAL EQUIPMENT IS EXISTING EXCEPT AS NOTED.
5		STAKE ALL R.O.W. PRIOR TO EXCAVATION.
6		STATE FORCES TO STAKE ALL R.O.W. PRIOR TO EXCAVATION.
7		ANY PROPOSED REVISIONS TO THE LOCATION OF THE APPURTENANCES SHOWN ON THE PLAN MUST BE SUBMITTED FOR REVIEW AND APPROVAL BY THE DIVISION OF TRAFFIC ENGINEERING PRIOR TO INSTALLATION.
8		THE LOCATION OF TRAFFIC SIGNAL APPURTENANCES (MAST ARMS, SPAN POLES, PEDESTALS, AND HAND HOLES) WHEN IN OR ADJACENT TO SIDEWALKS SHALL BE VERIFIED PRIOR TO INSTALLATION TO PROVIDE A FREE PATH OF NOT LESS THAN 3 FEET. IF A MINIMUM 3 FOOT FREE PATH IS UNAVAILABLE THE CONTRACTOR MUST CONTACT THE DIVISION OF TRAFFIC ENGINEERING.
15	⊙	INSTALL FOUNDATION ADJACENT TO AND WITHIN R.O.W.
16	⊙	INSTALL CONTROLLER AND SPAN POLE FOUNDATIONS ADJACENT TO AND WITHIN R.O.W.
18		INSTALL _____ FOUNDATION ADJACENT TO WALK AT BACK EDGE.
20	⊙	INSTALL NEW SPAN POLE FOUNDATION ADJACENT TO OLD SPAN POLE FOUNDATION.
30		MODIFY EXISTING CONTROLLER TO ACCOMMODATE CHANGES. SUPPLY 3 COPIES OF REVISED CABINET WIRING DIAGRAMS.
33		INSTALL CONCRETE SIDEWALK ON CABINET DOOR SIDE OF CONTROLLER FOUNDATION AS SHOWN ON TYPICAL INSTALLATION DETAIL SHEET.
34		CABINET DOOR TO OPEN FIELD SIDE.
35		CABINET DOOR TO OPEN STREET SIDE.
45	⊙	LOCATE EXISTING RIGID METAL CONDUIT. EXTEND INTO NEW HANDHOLE.
48	⊙	INSTALL 30" X 30" HANDHOLE. ALL OTHERS TYPE II.
49		INSTALL HANDHOLES APPROX. 1' BEHIND CURB OR EDGE OF ROAD UNLESS OTHERWISE SPECIFIED.
51		INSTALL INTERCONNECT HANDHOLES EQUALLY SPACED, APPROX. ___ APART.
52	⊙	INSTALL CAST IRON HANDHOLE COVER.
61		INSTALL LOOP DETECTORS 3' OFF EDGE OF ROAD AND 8' APART UNLESS OTHERWISE SPECIFIED.
62	⊙	SEE "TYPICAL INSTALLATION DETAIL, INDUCTIVE LOOP VEHICLE DETECTORS" SHEET. THE NEW SAW CUT INSTALLATION PROCEDURE HAS CHANGED.
63		LOOP DETECTORS TO BE CENTERED IN LANE.
64		SERIES SPLICE SEGMENTED LOOPS PER LANE.
79		INSTALL CABLE CLOSURE, 16/12 PAIR FIGURE 8 CABLE & 16/6 PAIR INTERCONNECT CABLE.
92	⊙	REPLACE PEDESTRIAN SIGNAL FACE AND PUSH BUTTON, USE EXISTING PEDESTAL FOUNDATION AND PEDESTAL.
93		REMOVE ALL ABANDONED TRAFFIC SIGNAL EQUIPMENT INCLUDING, BUT NOT LIMITED TO TO FOUNDATIONS, HANDHOLES, CONDUIT RISERS & CABLE, MESSENGER & INTERCONNECT, STEEL POLES, AND WOOD POLES.

Figure 21-1 Commonly Used Construction Notes

22 GLOSSARY

Actuated	Type of control which responds to vehicle or pedestrian detection.
Amplifier	A device used in a vehicle detection system that produces a signal when a vehicle passes through or remains within the detection zone of a sensing element.
Artery	An arterial or main street generally considered the thoroughfare with preferential right-of-way.
Background Cycle	Term used in coordinated systems to identify the cycle lengths established by coordination unit and master control; takes precedence over intersection control cycle length.
Bandwidth	The amount of green time available to a platoon of vehicles to travel without stopping through all intersections in a progressive signal system. Also referred to as through band.
Barrier	Reference point in the sequence of a dual ring controller unit (CU) at which all rings are interlocked. Barriers assure that conflicting phases in different rings will not time concurrently. In a dual quad sequence the barriers are after phases 2 & 6 and after phases 4 & 8. Rings cross the barrier simultaneously.
Beginning of Green	The theoretical beginning of artery green of a signal in a coordinated system when all phases max out.
Call	A registration of a demand for right-of-way by traffic (vehicular or pedestrian) to a controller.
Centralized System	A computer control system in which the master computer, central communication facilities, console, keyboard and display equipment are all situated at a single location. From this center, the operating staff coordinates and controls traffic signals and related traffic control functions throughout the area.
Controller Assembly	A group of electrical devices, including the controller unit, conflict monitor, vehicle detectors, and other auxiliary equipment housed in an enclosure that together provide the operation of a traffic signal.

Controller Unit	A microprocessor based device that receives various inputs (vehicle/ped detectors, pre-emption, coordination data) and is programmed to provide the specific traffic signal phase sequence, timing, and overall operation as shown on the traffic plan.
Coordination	The establishment of a definite timing relationship between adjacent traffic signals in a system.
Cycle Length	The time required for one complete sequence of signal phases.
Detector (Vehicle)	A general term for a device that senses the presence or passage of vehicles. An additional descriptive term is usually attached indicating the type or function (i.e. loop detector, video detector, presence detector, system detector).
Dual Ring Operation	Phasing sequence consisting of two interlocked rings. Concurrent timing of non-conflicting phases in both rings is allowed subject to the restraint of the barrier.
Dummy Phase	A phase in the sequence that is used to obtain a special type of operation such as a flashing sign clearance. The phase interval times are programmed but the green, yellow and red outputs are not used.
Force-Off Command (FO)	A coordination or pre-emption command that forces the termination of the green interval regardless of the vehicle demand.
Gap	The distance between vehicles, usually measured in time.
Minimum Gap	A setting of the Gap Reduction feature on an actuated controller. The setting establishes the lowest passage time (vehicle spacing) before the phase gaps out.
Gap Reduction	A volume density feature of an actuated controller whereby the vehicle extension time is reduced to a preset minimum over a preselected period of time. The functional settings are time before reduction, extension, minimum gap, and time to reduce.
Green Band	Through or green elapsed time between the first and last possible vehicle permitted through each intersection in a progressive coordination system.

Interval	Any one of the several divisions of the time cycle during which signal indications do not change.
Loop Detector	Also known as Inductive Loop Detector (ILD). A device capable of sensing a change in inductance of a loop of wire imbedded in the roadway caused by the passage or presence of a vehicle over the loop.
Manual Pattern	A set of controller cycles, splits, and offsets for a traffic control network (or sub-network) which determines the relative green light sequencing of the intersections within the network (or sub-network) and which can only be selected through an operator command.
Mode (Detector)	A detector setting that selects how the detector outputs the call to the controller unit (i.e. presence, pulse, delay).
Mode (Phase)	A phase setting that selects how a phase operates in the sequence (i.e. lock, non-lock, minimum recall, maximum recall, pedestrian recall).
Offset	The time difference from the reference line of the system to the beginning of the artery yellow interval at each intersection.
Operations Center	Consists of the room(s) that contains the computer equipment, displays and controls and houses the personnel which operate this equipment used in a computerized traffic control system.
Parent Phase	A phase with which the operation of a subordinate phase, dummy phase, or a pre-emption movement is dependent.
Permissive Period	An extension of the yield period in which the controller will yield (transfer) to another phase.
Phase	The part of the total time cycle allotted to any traffic movement receiving the right-of-way. Thus, the main street green, yellow and red intervals make up the main street phase.
Pre-Emption	Pre-Emption Definitions and Pre-Emption Settings Definitions are included in Chapter 9.

Recall	A phase mode in an actuated controller which will cause the automatic return of the right-of-way to a street without vehicle or pedestrian demand. Usually applied to a non-actuated movement.
Reference Line	A line perpendicular to the time axis on a time space diagram. It should normally be drawn through the beginning of the artery yellow at the master location.
Ring	Two or more conflicting phases arranged to occur in an established order.
Single Ring Operation (Sequential)	Phasing sequence consisting of one ring. One phase must terminate before another becomes active.
Special Event Plan	A timing plan (a set of cycles, splits and offsets) stored in memory which is activated to compensate for unusual traffic flow caused by a special event (such as a football game).
Split	The segment of the system cycle length allocated to each phase that may occur (expressed in percent and seconds). All splits add up to 100 percent or the cycle length.
Standby Mode	An operational status of a local controller assembly or system which is not under central computer control but is capable of responding to central computer control.
System	Two or more traffic signals operating in coordination.
System Detector	Any type of detector that is used for traffic information such as speed, volume, and occupancy.
Time-Base Coordination	Type of coordination which uses an electronic clock, rather than an interconnect cable.
Time Before Reduction (TBR)	A setting of the Gap Reduction feature of an actuated controller. The setting delays the start of gap reduction.
Time to Reduce (TTR)	A setting of the Gap Reduction feature of an actuated controller. The setting establishes the rate of reduction.
Time-of-Day Plan	A timing plan (set of cycles, splits, and offsets) for a section which is automatically implemented at certain time(s) in the day by a pre-set schedule.

Timing Plan	A set of timing patterns (cycles, splits and offsets) within a section of signals. The particular timing for each intersection may vary with time of day within the plan.
Traffic Responsive Plan	A timing plan (set of cycles, splits, and offsets) for a section which is implemented in response to the real time demands of traffic as sensed by the vehicle detectors.
Variable Initial	A volume density feature of an actuated controller whereby the minimum green interval can be increased to accommodate the number of vehicles which have passed over the approach detectors when the phase is in yellow or red. The functional settings are minimum green, added initial (seconds per actuation), and max initial.
Vehicle Headway	The distance between the fronts of two successive vehicles measured in time.
Volume Density	A controller operation that will automatically adjust the timing of a phase by using variable initial and/or gap reduction. For detailed description refer to NEMA TS2 Standards.
Yield Period	The part of the signal cycle during which the coordinated phase is allowed to terminate its green interval. Usually 3% of the cycle length.
Yield Point	The point where the coordinated phase yields to another phase (beginning of artery yellow).

23 SIGNAL MANUAL COMMENT SHEET

Should you have any comments or questions, please complete the form below and return it to:

Mr. Gregory R. Palmer, P.E.
Transportation Engineer
Division of Traffic Engineering
Connecticut Department of Transportation
P. O. Box 317546
Newington, Connecticut 06131-7546

Attention: Signal Manual Comments

FAX (860) 594-3376
E-MAIL Gregory.Palmer@ct.gov

COMPANY
NAME _____

ATTENTION: _____

ADDRESS: _____

PHONE (____) _____

FAX (____) _____

E-MAIL _____