

CONSTRUCTION MANUAL

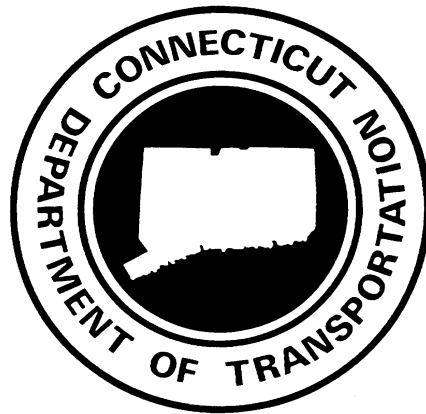

CONNECTICUT DEPARTMENT OF TRANSPORTATION

**BUREAU OF ENGINEERING AND HIGHWAY
OPERATIONS**

OFFICE OF CONSTRUCTION

~ Version 3.1 January 2020 ~

Table of Contents

Rev.

Preface..... 1-0.1 Jan 2020

Chapter 1 – Inspection

1-100 General..... 1-1.1

1-101 Scope of the Work..... 1-1.1

1-102 Initiating Inspection 1-1.1

1-103 The Inspection Team..... 1-1.2

1-103A The Inspector 1-1.2 Jan 2020

1-103B The Project Engineer..... 1-1.5 Jan 2020

1-103C The Supervising Engineer (TSE) 1-1.8 Jan 2020

1-103D The Assistant District Engineer (ADE)..... 1-1.10 Jan 2020

1-104 Time on Project..... 1-1.12

1-105 Address of Inspectors..... 1-1.12

1-106 Enforcing the Provisions of the Contract 1-1.12

1-107 Safety 1-1.13 Jan 2020

1-108 Change in Travelway Clearances and Bridge Capacity Ratings 1-1.14 Jan 2020

1-109 Data, Supplies and Equipment 1-1.14 Jan 2020

Chapter 2 – Project Initiation

1-201 Project Start Up..... 1-2.1 Jan 2020

1-202 Preconstruction Meetings..... 1-2.1 Jan 2020

1-203 EEO Preconstruction Meeting..... 1-2.2

1-204 Utility Meeting..... 1-2.3

1-205 Notification of Contract Status..... 1-2.3 Jan 2020

Chapter 3 – Project Documentation

1-300 General..... 1-3.1 Jan 2020

1-300A Electronic File Naming Convention..... 1-3.2 Jan 2020

1-300B Use of Electronic and Digital Signatures 1-3.2 Jan 2020

1-301 Engineering Generated Project Documents 1-3.3 Jan 2020

1-302 Field Records 1-3.3 Jan 2020

1-302A Field Notes 1-3.4 Jan 2020

1-302B Use of SiteManager..... 1-3.5 Jan 2020

1-302C	Measurements and Calculations.....	1-3.5	Jan 2020
1-303	Diaries and Inspector’s Daily Work Reports	1-3.8	Jan 2020
1-303A	Diaries.....	1-3.8	Jan 2020
1-303B	Daily Work Report (DWR).....	1-3.9	
1-303C	Review of DWRs.....	1-3.10	
1-303D	Daily Paving Reports	1-3.12	
1-304	<i>Vacant</i>		
1-305	Volume III – Extensive Calculations	1-3.13	Jan 2020
1-305A	Drainage Books.....	1-3.14	Jan 2020
1-305B	Structures, Mainline, Ramps Etc.....	1-3.15	
1-306	Volume IV – Miscellaneous Contract Data	1-3.15	Jan 2020
1-307	Volume V – Field Notes and Reporting Forms.....	1-3.16	
1-308	Project Correspondence	1-3.17	Jan 2020
1-309	Progress Meetings.....	1-3.18	
1-310	Other Project Booklets and Folders	1-3.18	
1-311	Non-Compliance Notices.....	1-3.19	Jan 2020
1-312	Working Drawings.....	1-3.21	Jan 2020
1-312A	Working Drawings for Permanent Construction.....	1-3.21	Jan 2020
1-312B	Working Drawings for Temporary Construction	1-3.21	Jan 2020
1-312C	Examples of Working Drawings That Require a Review by the Office of Engineering.....	1-3.22	
1-313	Shop Drawings.....	1-3.22	Jan 2020
1-314	As-Built Drawings and Final Revisions of Plans.....	1-3.23	Jan 2020
1-315	Recycling of Construction Material Reports.....	1-3.25	
1-316	Requests for Information, Engineering Clarification Memos, and Request for Change.....	1-3.26	

Chapter 4 – Materials Testing

1-401	General Responsibilities	1-4.1	Jan 2020
1-401A	District Construction.....	1-4.1	Jan 2020
1-401B	Division of Materials Testing.....	1-4.2	
1-402	Standard Procedures.....	1-4.3	
1-402A	General.....	1-4.3	Jan 2020
1-402B	Bituminous Concrete Production Notification	1-4.4	
1-402C	Project Staff Inspections	1-4.4	Jan 2020
1-402D	MAT-100, Request for Test	1-4.5	Jan 2020

1-402E	SiteManager	1-4.6	Jan 2020
1-402F	Assurance Samples and Tests	1-4.9	
1-402G	Test Results	1-4.9	
1-402H	Samples Recommended for Rejection	1-4.10	
1-402I	Buy America	1-4.10	
1-402J	Structural Steel Fabrication Inspection Off-Site	1-4.11	
1-402K	Non-Standard Testing Procedures.....	1-4.12	
1-402L	Specialty and Proprietary Items	1-4.12	Jan 2020
1-403	Materials Certificate (MC).....	1-4.12	Jan 2020
1-404	Certified Test Report (CTR)	1-4.12	Jan 2020
1-405	Final Material Certification (FMC).....	1-4.13	

Chapter 5 – Adjustment of Contract Items and Differing Site Conditions

1-500	General	1-5.1	Jan 2020
1-501	Minor Items – Article 1.04.02.....	1-5.1	Jan 2020
1-501A	Increases of more than 25%	1-5.2	Jan 2020
1-501B	Decreases of more than 25%	1-5.2	Jan 2020
1-501C	Eliminated Contract Items.....	1-5.3	Jan 2020
1-502	Change in Quantities (of Major Items) and Significant Changes in the Character of Work – Article 1.04.03	1-5.3	Jan 2020
1-503	Differing Site Conditions – Article 1.04.04	1-5.4	Jan 2020
1-503A	“TYPE I” Differing Site conditions	1-5.5	Jan 2020
1-503B	“TYPE II” Differing Site conditions	1-5.5	Jan 2020
1-503C	Differing Site Conditions Definitions	1-5.6	Jan 2020
1-503D	Examination of Site Clauses	1-5.7	Jan 2020
1-504	Differing Site Condition Contract Adjustment Approval	1-5.7	Jan 2020
1-505	Adjusted Price Forms for Major Items, Change in Character of Work and Differing Site Conditions	1-5.7	Jan 2020

Chapter 6 – Extra and Cost-Plus Work

1-600	Extra Work Determination.....	1-6.1	Jan 2020
1-601	Agreed Price.....	1-6.2	Jan 2020
1-602	Cost Plus	1-6.3	Jan 2020
1-602A	Labor Rates	1-6.7	
1-602B	Labor Additives	1-6.7	Jan 2020

1-602C	Bonding Costs.....	1-6.10	
1-602D	Specialized Work.....	1-6.11	
1-602E	Administrative Expenses.....	1-6.11	
1-602F	Small Tools.....	1-6.11	
1-602G	Contractor Owned Equipment.....	1-6.11	
1-602H	Idle Equipment.....	1-6.12	
1-602I	Rented Equipment.....	1-6.12	
1-602J	Materials.....	1-6.13	

Chapter 7 – Schedules, Time Extensions and Suspensions

1-700	Scheduling.....	1-7.1	Jan 2020
1-700A	Schedule Reviews During Design Phase.....	1-7.1	Jan 2020
1-700B	Pre Award Submittal.....	1-7.1	
1-700C	Post Award Submittals – Baseline and Progress Schedules.....	1-7.2	
1-701	Documentation of Delays and Impacts.....	1-7.2	Jan 2020
1-702	Time Extension Procedures.....	1-7.3	
1-702A	Time Extension Authority.....	1-7.3	
1-702B	Time Extension Requests.....	1-7.3	Jan 2020
1-702C	Time Extension Analysis.....	1-7.4	Jan 2020
1-702D	Standard Reference for Time Extension Reasons.....	1-7.5	
1-702E	Federal Agency Approval.....	1-7.5	
1-702F	Assistant District Engineer Approval/Disapproval.....	1-7.6	Jan 2020
1-703	Temporary Suspensions and Resumptions.....	1-7.6	Jan 2017

Chapter 8 – Construction Orders

1-800	General.....	1-8.1	
1-801	Review of Proposed Changes.....	1-8.1	Jan 2020
1-801A	Proposed Changes that Require Additional Approvals.....	1-8.2	
1-801B	Review of Changes for Federal Eligibility.....	1-8.2	
1-802	General Processing Guidelines.....	1-8.4	Jan 2020
1-803	CO Development.....	1-8.4	
1-804	CO Approval Requirements.....	1-8.5	Jan 2020
1-804A	Approval Requirements by the Office of Construction.....	1-8.5	
1-804B	Requirements by the Federal Highway Administration (FHWA).....	1-8.5	Jan 2020
1-805	Design Initiated COs (DICO).....	1-8.5	Jan 2020
1-805A	Analysis of Design Initiated COs (DICO).....	1-8.6	Jan 2020

1-806	CO Addendum	1-8.6	Jan 2020
1-807	Standard Paragraphs Explanations - Classification of Line Item Changes	1-8.7	
1-808	Authorization Levels to Process COs.....	1-8.8	
1-809	District Review and Processing Procedure	1-8.9	
1-809A	Review by Project Engineer.....	1-8.9	
1-809B	Review by TSE	1-8.9	Jan 2020
1-809C	Review and Initial Processing by District.....	1-8.9	
1-809D	Processing by Project Engineer.....	1-8.10	Jan 2020
1-809E	Processing by TSE	1-8.10	Jan 2020
1-809F	Final Processing by District	1-8.10	Jan 2020
1-809G	Distribution	1-8.10	
1-810	Final CO.....	1-8.10	

Chapter 9 – Contract Payments

1-901	Estimated Progress Payments	1-9.1	Jan 2020
1-902	Estimate Period	1-9.1	
1-903	Estimate Preparation and Review	1-9.1	
1-904	Construction Budget	1-9.2	Jan 2020
1-905	Retainage and Securities	1-9.2	Jan 2020
1-906	Extra or Additional Work	1-9.2	Jan 2020
1-907	Liquidated Damages, Sanctions, and Item Adjustments	1-9.2	Jan 2020
1-908	Deductions	1-9.3	
1-909	Payment for Stored Materials.....	1-9.3	
1-909A	General Requirements.....	1-9.3	Jan 2020
1-909B	Materials Stored On-Site or Off-Site within State (Except Raw or Partially Fabricated Materials)	1-9.6	
1-909C	Materials Stored Out of State (Except Raw or Partially Fabricated Materials).....	1-9.6	
1-909D	Raw or Partially Fabricated Materials.....	1-9.7	
1-910	Payment to Subcontractors and Suppliers.....	1-9.8	Jan 2020
1-911	Credits due State	1-9.8	
1-912	Estimated Payments	1-9.9	
1-912A	Partial Payments.....	1-9.9	
1-913	Lump Sum Items.....	1-9.10	
1-914	Accuracy of Measurements and Computations.....	1-9.11	Jan 2020
1-915	Estimated Items / Adjustment Items	1-9.11	
1-916	Water Pollution Control	1-9.11	Jan 2020

Chapter 10 – Contract Completion

1-1000	General.....	1-10.1	Jan 2020
1-1001	Semi-final Inspection	1-10.1	Jan 2020
1-1002	Notice of Substantial Completion and Stopping Contract Time	1-10.2	Jan 2020
1-1002A	Final Material Certification.....	1-10.3	Jan 2020
1-1003	Final Inspection.....	1-10.3	Jan 2020
1-1003A	Various Location Projects	1-10.4	Jan 2020
1-1004	OOA Advisory Team Semi- Final Inspection and Final Pavement Evaluation.....	1-10.4	Jan 2020
1-1005	Certificates of Compliance (CON-502 Series).....	1-10.4	Jan 2020
1-1006	Termination of Contractor’s Responsibilities & Certificate of Acceptance of Work (CON-500)	1-10.5	Jan 2020
1-1007	District and Headquarters Reviews	1-10.5	Jan 2020
1-1008	Checks to Final a Contract	1-10.5	Jan 2020
1-1009	Final Estimates	1-10.6	Jan 2020
1-1010	Acceptance of Project	1-10.6	
1-1011	Final Package	1-10.7	Jan 2020
1-1012	Submission of Final Documents to Other Offices and Agencies	1-10.7	Jan 2020
1-1013	CE&I Consultant-Inspected Projects	1-10.8	Jan 2020
1-1014	Storage of Revised Plans and Notebooks.....	1-10.8	Jan 2020
1-1015	Post Construction Reviews (PCR)	1-10.8	Jan 2020
1-1016	Contractor Evaluations.....	1-10.9	Jan 2020

**Chapter 11 – Guidelines for the District Intermediate Reviews
and Headquarters Intermediate and Final Reviews**

1-1101	District and Headquarters Intermediate and Final Reviews	1-11.1	Jan 2020
1-1101A	Items.....	1-11.3	
1-1101B	Volume I – Inspector’s Daily Work Report	1-11.4	
1-1101C	Volume II – (Non-SiteManager Projects)	1-11.4	
1-1101D	Volume III – Computations	1-11.4	
1-1101E	Volume IV – Miscellaneous Contract Data	1-11.4	
1-1101F	Volume V – Field notes and Reporting Forms.....	1-11.4	
1-1102	Emergency Cost-Plus Projects	1-11.4	
1-1103	Facility Construction.....	1-11.4	

Chapter 12 – Civil Rights, Labor and Contract Compliance

1-1200	General.....	1-12.1	
1-1201	Frequently Used Terminology	1-12.1	Jan 2020
1-1201A	Role of Office of Construction (OOC) – Subcontracting Unit.....	1-12.2	Jan 2020
1-1201B	Role of the District EEO Coordinators	1-12.2	Jan 2020
1-1201C	Role of the Inspector/Project Engineer relating to DBE/SBE/EEO/AA/CUF/PAC Requirements.....	1-12.4	
1-1202	DBE Goal or SBE Set-Aside Goal Contract Participation.....	1-12.5	
1-1202A	DBE / SBE Reports.....	1-12.7	
1-1202B	Final DBE / SBE Reports.....	1-12.7	
1-1202C	DBE / SBE Compliance and Shortfall Procedure	1-12.7	
1-1203	(CLA-12): Subcontracting - Work Performed by the Subcontractor	1-12.8	
1-1203A	Prompt Payment Complaints.....	1-12.10	
1-1204	Statements and Payrolls	1-12.12	
1-1204A	Salaried Employees.....	1-12.14	
1-1205	Wage Rate Checks	1-12.14	
1-1205A	Wage Rate Check Forms.....	1-12.15	
1-1205B	Processing CTDOL/USDOL Complaints or Violations for Wages/Certified Payrolls/EEO.....	1-12.15	
1-1205C	Compliance and Requirements for the Department of Labor	1-12.16	
1-1206	Quarterly Construction Engineering and Inspection (CEI) Consultants Reports and Sub-Consultant Payment Log.....	1-12.16	
1-1207	Monthly and Bi-Monthly Contractor Reports Verified Payment Reports.....	1-12.17	
1-1208	Site Record Review Monitoring by EEO Coordinator For Equal Employment Opportunity.....	1-12.17	
1-1209	Freedom of Information	1-12.18	

Chapter 13 – Utility Coordination and Administration

1-1300	General.....	1-13.1	Jan 2020
1-1301	Design Phase.....	1-13.1	
1-1302	Preconstruction Phase	1-13.1	
1-1303	Construction Phase.....	1-13.2	
1-1303A	Utility Coordination	1-13.2	
1-1303B	Inspection and Record Keeping	1-13.3	
1-1303C	Review and Signature of CON 40's, CON 41's and Railroad Force Account Reports.....	1-13.5	

1-1303D	Change in Scope and Cost Overrun Requests	1-13.8
1-1303E	Handling of Requests More Than 60 Days After Project Completion.....	1-13.9

Chapter 14 – Project Incidents and Complaints

1-1401	Reporting Damage or Injury Claims	1-14.1
1-1402	Telephone Complaints	1-14.1
1-1403	Property Owner Complaints.....	1-14.1
1-1404	Improprieties	1-14.2
1-1405	Motorists Claims	1-14.2 Jan 2020
1-1406	Other Property Damage and Personal Injury Claims	1-14.3
1-1407	Claims Against the State	1-14.3
1-1408	Claims Against the Contractor	1-14.4
1-1409	Major Project Incident	1-14.4
1-1410	Report of Burglary, Theft, or Vandalism of State-Owned Property	1-14.8

**Chapter 15 – Disputes, Claims, Compensable Time,
and Other Precedent Setting Actions**

1-1500	General.....	1-15.1	Jan 2020
1-1501	District Notification and Approval Requirements.....	1-15.1	Jan 2020
1-1502	Contractor’s Right to Claim	1-15.2	Jan 2020
1-1503	The Dispute & Claim Process	1-15.2	Jan 2020
1-1504	Waivers of Claim and Releases.....	1-15.4	
1-1505	Claims and Disputes Status	1-15.5	

Chapter 16 – Construction and Design Issues

1-1600	General.....	1-16.1	Jan 2020
1-1601	Construction Issue Form	1-16.1	
1-1601A	The District Responsibilities	1-16.1	
1-1601B	The Office of Construction Responsibilities	1-16.2	
1-1602	Active Claim by Contractor	1-16.2	
1-1603	Design Issue Panel	1-16.2	Jan 2020

Chapter 17 – Consultant Engineers

1-1700(a)	Consultant Administration	1-17.1	Jan 2020
1-1700(b)	Task-based Consultant Services.....	1-17.1	
1-1701	Consultant Evaluations	1-17.2	Jan 2020
1-1702	Semi-annual Consultant Evaluation Procedures	1-17.2	Jan 2020
1-1703	Consultant Performance Evaluation Rating Guidance	1-17.2	Jan 2020
1-1704	Consultant DBE/SBE Administration.....	1-17.3	Jan 2020

Chapter 18 – Emergency Declaration Projects

1-1800	General.....	1-18.1	
1-1801	Emergency Declaration Initiation Procedure (Office of Construction).....	1-18.1	Jan 2020
1-1802	Emergency Declaration Project Administration.....	1-18.5	Jan 2020
1-1803	Recordkeeping and Administration of Emergency Projects	1-18.5	
1-1804	Procedures Relating to DEEP Authorization	1-18.6	Jan 2020

Chapter 19 – Insurance and Bond Requirements

1-1901	Insurance Requirements	1-19.1	Jan 2020
1-1902	Performance Bonds	1-19.1	Jan 2020

**Chapter 20 – Maintenance and Protection of Traffic (M&PT)
Changes and Public Relations**

1-2000	General.....	1-20.1	
1-2001	Procedures for Revising Contract Provisions for M&PT.....	1-20.1	
1-2001A	Case 1 – Revision to the Traffic Management Plan (TMP) or M&PT Plan....	1-20.1	
1-2001B	Case 2 – Revision to Limitation of Operations	1-20.2	Jan 2020
1-2001C	Case 3 – Emergency Operations	1-20.2	
1-2002	Work Zone Safety and Mobility	1-20.4	Jan 2020
1-2002A	Ramp Closures	1-20.4	
1-2003	Press Release Procedures	1-20.5	
1-2004	Public Relations on the Job Site.....	1-20.6	
1-2004A	Pedestrian Access - Americans with Disabilities Act	1-20.6	
1-2005	Trafficperson and State Police	1-20.7	
1-2005A	Municipal Police Officers and Uniformed Flaggers	1-20.7	
1-2005B	State Police.....	1-20.9	

1-2005B-1	Ordering State Police Services for Highway Construction Projects (HCP) Procedures.....	1-20.9	
1-2005B-2	Project Close Out	1-20.9	Jan 2020
1-2006	Barricade Warning Lights	1-20.9	
1-2007	Opening to Traffic or Occupancy Including State Shifts	1-20.9	
1-2008	Rolling Road Block Procedures	1-20.10	Jan 2020
1-2008A	Rolling Road Block Additional Information.....	1-20.11	Jan 2020

Chapter 21 – Municipal Systems Oversight Procedures

1-2100	General.....	1-21.1	
1-2101	MSAT Responsibilities	1-21.1	Jan 2020
1-2102	Design/Constructability Reviews.....	1-21.1	
1-2103	Preliminary Meeting with the Municipality	1-21.2	Jan 2020
1-2104	MSAT Project Status	1-21.4	
1-2105	Municipal Preconstruction Meeting	1-21.4	Jan 2020
1-2106	Municipal Testing Procedures.....	1-21.4	Jan 2020
1-2107	Municipal Contract Status Report, CON 100M	1-21.5	Jan 2020
1-2108	Invoice Summary and Processing (ISP) for Projects Performed by Contractor/Consultant	1-21.5	Jan 2020
1-2109	ISPs for Projects Performed by Municipal Force Account	1-21.6	Jan 2020
1-2110	Change in Scope Approval Process	1-21.6	Jan 2020
1-2111	Municipality Construction Orders.....	1-21.7	Jan 2020
1-2112	Claim Procedures	1-21.7	Jan 2020
1-2113	Project Intermediate Records Review	1-21.8	Jan 2020
1-2113A	Final Review of Project Records	1-21.11	
1-2114	Semifinal and Final Inspection	1-21.11	
1-2115	Closing Out Projects	1-21.12	Jan 2020
1-2116	Submission of Finals Package to Office of Construction.....	1-21.12	Jan 2020

Chapter 22 – Facilities Construction

1-2201	Overview.....	1-22.1	
1-2202	Unit Responsibilities	1-22.1	Jan 2020
1-2203	Obtaining a Certificate of Substantial Compliance	1-22.4	
1-2204	Construction Specification Institute (CSI) Items	1-22.5	
1-2205	Project Start Up.....	1-22.5	
1-2206	Payment Estimates	1-22.6	

1-2207	Testing	1-22.8
1-2208	Field Design Changes (FDC's)	1-22.8
1-2209	Contract Closeout.....	1-22.9
1-2210	Reports and Records	1-22.9
1-2211	Code Inspections Schedule	1-22.10

Chapter 23 – Value Engineering Change Proposals

1-2300	General.....	1-23.1
1-2301	Department Responsibilities	1-23.1
1-2301A	VECP Analysis	1-23.1 Jan 2020
1-2301B	VECP Acceptance or Rejection Procedures.....	1-23.2
1-2302	Incorporation of Accepted VECP into Contract.....	1-23.3
1-2303	VECP Payments.....	1-23.3

Appendix A – SiteManager 3.15a User Guide

Appendix B – Update Procedures

B-100	General.....	B-1.1
B-101	Responsibilities	B-1.1
B-102	Construction Manual Panel	B-1.1
B-103	Construction Manual Coordinator.....	B-1.1
B-104	Types of Changes.....	B-1.3
B-105	Sources of Changes.....	B-1.4
B-106	Procedures for Making Changes to Construction Manual	B-1.4
B-107	Suggesting Revision to the Standard Specifications	B-1.5 Jan 2020

Appendix C – The List of Standard Correspondence

C-101	List of Standard Correspondence	C-1.1
C-102	Standard List of Project Correspondence to be Maintained in Folders at the Field Office	C-1.4

Appendix D – Approved Forms and Inspection Checklists

D-100	Approved Forms and Inspection Checklists.....	D-1.1
-------	---	-------

Preface

1-000 General

This Manual, in conjunction with the *Standard Specifications for Roads, Bridges, Facilities and Incidental Construction*, outlines the organization, policies and procedures of the Department in administering construction contracts from their execution to completion, and serves to clarify and unify construction procedures and practices.

The Construction Manual is arranged into two major volumes, each containing associated chapters and relevant appendices. Volume 1 – “Contract Administration” addresses administration procedures. Volume 2 – “Technical References” addresses the technical aspects of the various construction areas and provides guidance to the inspector.

The scope of the Manual is primarily confined to construction practices and the proper handling of related contingencies that may arise. The Manual does not include discussions of the numerous technical questions involved in highway engineering. Technical questions concerning the detail of the project design should be referred to the appropriate section within the Office of Engineering. The material is arranged chronologically where possible, following the order in which work is normally developed, and is separated to reflect the following:

- Administration. The formulation and administration of policies and procedures to obtain uniformity throughout the State.
- Inspection. The inspection of all of the operations during construction of a project to assure the proper combination of materials and details of construction that meet all the requirements of the plans, specifications, and special provisions as set forth in the contract.

This manual was written to instruct the Department and Consultant staff in the performance of their duties associated with the administration and inspection of construction contracts. Unless specifically noted in the Manual as discretion of the Districts or general guidance, the provisions of this manual shall be considered the minimum requirements for uniform record keeping and administration. The Contract is the final control in the inspector-contractor relationship. The requirements of the Standard Specifications, special provisions, plans and subsequent policy and procedure memoranda take precedence if there are any conflicts with instructions in this manual.

Chapter 1 - Inspection***1-100 General***

Public employees entrusted with the administration of construction projects must be mindful of the fact that they are “stewards of the public trust.” Each year the Department of Transportation (CTDOT) is allocated public funds for the construction of roads, bridges, buildings, and other transportation related projects. With this comes a responsibility, in the most efficient manner, to achieve the highest quality product attainable. To do any less would be a violation of the public trust that our organization is founded upon.

Inspection is one of the most important phases of construction work. It is quality assurance of the Contractors’ work, not control of the Contractors’ work. It is important to be aware of and adhere to Section 1.05.09 -“Authority of Inspectors”. Inspection consists of careful review and critical examination of all the factors entering into the construction of transportation projects to assure the proper combination of materials and details of construction. The goal is for the Contractor to produce a completed project complying with all the requirements of plans, specifications, and the special provisions as set forth by CTDOT.

The inspection of a project can be performed entirely by state employees or by private engineering firms hired by CTDOT. Private consultant engineering firms are referred to as Construction Engineering and Inspection (CEI) firms.

When used, CEIs represent the Commissioner and act as agents of the State in accordance with the terms of their agreements with CTDOT and under the supervision of CTDOT personnel. Their actions in the prosecution of their duties must be in accordance with the established policies of the Department and in the best interest of the State.

If the District determines that insufficient personnel are available to staff a project, the Assistant District Engineer should notify the Office of Construction (OOC) using the [Consultant Solicitation Request](#) form. The OOC will request the Commissioner's approval to assign the work to a consulting engineer.

For CEIs the duties referred to in this manual as Chief Inspector duties may be applied to the Resident Engineer or Chief Inspector positions.

1-101 Scope of the Work

The construction of a transportation project consists of a number of operations that must be integrated in order to produce a finished product. Each operation has an effect on the quality of the final product. The procedures and restrictions applicable to the work to be performed and the estimated quantities involved are specified in the Contract documents. The actual quantities incorporated into the work must be documented and certified. The certification must be based on documented field measurements and computations.

The intent of the construction Contract is to prescribe a complete work or improvement. Knowledge of the plan details, design computations, and Contract requirements is a necessity for the Inspector to properly fulfill the function of the Department representative.

1-102 Initiating Inspection

The Assistant District Engineer (ADE) is responsible for determining the appropriate staffing level on all projects in conjunction with the Transportation Supervising Engineer (TSE). The TSE will assign a Project Engineer (PE) and Chief Inspector (CI) to oversee and take charge of each project.

1-103 The Inspection Team

Each employee of CTDOT is a representative of the Commissioner and should conduct themselves in accordance with the Policies and Procedures of the Department, including the Code of Ethics. Employees shall act in the best interest of the Department consistent with the level of authority of their respective position. The following subsections are intended to outline the basic duties of certain positions and are not intended to be all inclusive. The specifics of the duties indicated are found elsewhere in this manual. Depending on the situation, the duties may be altered to fit the needs of the project(s).

Each project team must follow the procedures established in this manual to ensure that payments are made in accordance with the Contract. The CI will assign payment responsibilities to the project inspection staff to ensure that all required payments are made and that there are no overlaps or duplication. The Project Engineer (PE) will review payment procedures with the CI.

1-103A The Inspector

For CEI inspectors the duties referred to in this section as CI duties may be applied to the Resident Engineer (RE) position or as delegated.

The CI is assigned to a Project or Projects to see that the best interests of the State are served and that the Contractor works in accordance with the terms of the Contract.

One of the most important responsibilities of the inspector is to verify and document that the Contractor is performing the work in accordance with the Contract documents. The CI may delegate (except for Daily Work Report (DWR) approval) duties to Sub-Inspectors if approved by the Project Engineer (PE).

Inspector(s) must be fair, honest and strive to maintain a positive working relationship with the Contractor and their agent. The Inspector must be firm. Firmness in obtaining the required results from the start of the project will make the work of the inspection team easier as work progresses. **Inspectors should never act as supervisors for the Contractor**, and except in emergencies or in the interest of public safety, should only issue instructions to the Contractor's supervisory personnel. This approach serves to maintain the Contractor's authority over their personnel and should improve the relationship between the Contractor, the Inspector, and subcontractors.

If differences between the Inspector and Contractor concerning the interpretation of the plans and specifications cannot be reconciled at the project level, the CI will immediately contact the PE for a decision after all relevant information has been compiled.

In the absence of a PE or Supervising Engineer (TSE), if an immediate decision is required, the CI will make decisions according to the CI's best judgment and so direct the Contractor. The Inspector will, however, notify the PE of the decision and the reasons for the decision by the next working day. CIs cannot waive specifications, nor permit an inferior grade of work to be completed, or knowingly allow unapproved or rejected material to be incorporated into the project.

A list of various duties is provided below as an example and is not intended to be all inclusive. Depending upon the specific requirements of the construction project(s) which the Inspector is assigned, the required duties may vary. Further information related to the duties listed below can be found in other sections of this manual by specific topic.

Project Initiation

- Before actual operations are started by the Contractor, the CI must make a careful study of the Contract documents (see Chapter 2)
- The CI must also discuss the Project with key personnel (see Chapter 2).
- The CI must review the testing list to determine testing requirements for the materials of each item (see Chapter 2).
- The CI should attend the preconstruction meeting, preconstruction utility meeting and, preconstruction EEO meeting (see Chapter 2).
- Before Contract work begins the CI should review all agreements with second parties to determine what work involves credits due state. At this time it is also beneficial to review the Design Report as it may indicate what commitments should be in place. If there is an indication any commitments are missing the CI will check with the Designer for verification.
- It is the CI's responsibility to obtain all utility agreements, plans, specifications, estimates, and proposed schedules for utility work from the PE/District Utility Coordinator (DUC) and the Headquarters Utility Section.
- The CI is responsible to assemble the project records in accordance with the Construction Manual.
- Prior to the start of construction the CI should discuss the anticipated level of staffing required for the project with the PE based on the project's scope of work.
- The CI is responsible for the assignment of duties to the sub-inspectors. Prior to the start of the construction the CI should communicate to the Sub-Inspectors the expectations of their role in the project.
- At the preconstruction meeting, the CI should obtain the name, title and telephone number of the person(s) responsible for each utility's daily work and contact information for that person's supervisor.
- The CI is responsible for the preconstruction attendance sign in sheet and the Report of Meeting (ROM).

Throughout The Project

- When the Contractor begins operations, the CI must notify the PE, who notifies the Assistant District Engineer (ADE). The Inspector should record the actual starting date of the Contractor in the SiteManager system (DWR).
- The CI is to draft a Contract Status Report, Form CON-100 and provide to the District within seven (7) days for the following milestone dates:
 - order to start
 - actual start
 - suspension
 - resumption
 - substantial completion
- The CI is responsible to ensure that all forms and reports documenting the Contractors work, as well as those that may be required by other units of the Department and State and Federal agencies, are accurate and complete.
- The CI is responsible to verify that all Contractors/subcontractors are properly approved by the Office of Construction (OOC) prior to performing work on the project.
- The CI is expected to establish issue files for disputes between the Contractor and Department related to payment, design issues delays and other issues that may be of importance later. The CI should retain project correspondence and other documentation related to the particular issue in the folders.

- It is the responsibility of the CI(s) to review and approve all sub-inspectors' DWR content including attachments (see Chapter 3).
- The CI must make sure the information necessary to create the as-built drawings is kept up to date on white paper plans (or by other approved methods, see Chapter 3). The primary responsibility for adequate and sufficient acceptance testing rests with the CI. The CI must comply in all regards to the requirements stipulated in the "Schedule of Minimum Requirements for Sampling Materials for Test," or as directed. Items with a special provision typically add additional or revised testing requirements to the minimum testing requirements and must be reviewed for conformance.
- **Testing**
 - The CI is responsible for scheduling assurance testing as stipulated in the "Schedule of Minimum Requirements for Sampling Materials for Test." Notification of the Laboratory Supervisor is required to have appropriate assurance testing performed.
 - The CI must arrange for the delivery or pick up of samples of all materials to be used on the job, except those to be tested at the source of supply or by the District, to the DMT.
 - The CI should not make any payments until the Contractor has provided all testing requirements.
- **Additional Compensation Requests by the Contractor**
 - If the Contractor requests additional compensation for work included in the contract documents, the CI is responsible to carefully review the Standard Specifications, Addenda, Special Provisions, Permits, Plan Sheets, etc. to make sure the work is not included in other items or the general cost of the Project. Subsequent to a review, the CI should coordinate with the PE and TSE to determine if the Contractor's request is valid.
- **Extra Work**
 - The CI is required to keep the PE informed of requests by the Contractor regarding potential extra work. District supervisory personnel will determine if extra work is warranted and if so, if it will be paid for as agreed price or cost plus. Because the PE is responsible for the approval of the labor, equipment and materials used in the performance of cost-plus work, the CI should notify the PE when the cost-plus work begins.
- **Construction Orders**
 - The CI is responsible for the preparation and content of Construction Orders and must make regular checks of the project records to identify the need for a Construction Order to adjust item quantities.
 - The CI should keep the PE informed of the available funding for the Contract and must advise the PE when 75% of Project funds have been expended.
- **Prevailing Wage**
 - The CI is responsible to make sure all necessary labor wage checks are completed. CI must review the chapters in this manual related to DBE and EEO monitoring and make sure that the proper documentation is made.
- **Utility Work (CON-40)**
 - It is the CI's or delegated sub-inspectors responsibility to monitor and document utility work on the project. The CI should require that the utility's foreman check-in at the start of each workday, providing the work force, major equipment, location, nature of work, and anticipated end of workday. It is the CI's responsibility to verify the work charged on the CON-40 and CON-41 forms against the DWRs.

- **Complaints/Disputes**
 - All complaints from property owners that are received by project personnel must be investigated by the PE and CI and discussed with the property owner for resolution at the project level.
 - If there is a potential contractual dispute on a project, the Project Inspector involved should immediately bring the matter to the attention of the CI who will make a note of it on their Diary and notify the PE of the potential dispute.
- **Emergency Work**
 - If Contract operations of emergency nature are required, such as hazardous potholes patching, cleaning up of damaged sand barrels, repairing damaged bridge joints, etc., the CI/PE will request authorization to perform the necessary repairs from the TSE, ADE or District Engineer.
 - The CI/PE will be responsible for notifying the Operations Center and OOC of the proposed emergency work. The field inspectors are responsible for notifying the Operations Center at the completion of the work.
- **Environmental**
 - All Inspectors must be familiar with and follow the guidelines established in Volume 2 Chapter 1 “Environmental Protection”.

Project Completion

- The CI issues a Contract Status Report, Form CON-100, when the project is substantially complete.
- The CI will assist the PE in determining when the project or a portion of the project is ready for a semifinal inspection.
- The CI will record the dates that the remaining Contract work and any corrective work noted on the semi-final inspection report are completed. The CI will also notify the PE when all items noted on the report are satisfactorily addressed and the project is ready for a final inspection.
- The CI will record the dates the remaining Contract work or corrective work noted on the final inspection report are completed for inclusion in the Project records.
- As soon as the project is complete, the CI can put together a complete set of white paper tracings with all as-built information compiled during the project and forward them for additional processing to District Surveys for uploading to ProjectWise or the CI may elect to accept Training from the Engineering Applications Unit in Newington for the proper protocol for processing the as built drawings in ProjectWise.
- The CI is responsible for review and completion of the project records as well as completion of the final package.

1-103B The Project Engineer(PE)

The PE oversees a group of personnel in the administration of construction or other transportation projects, including design plan reviews. As part of this role the PE may also act as a liaison with consulting engineers, train inspectors and other staff, review and verify construction, schedules, and other estimates, serve as a technical advisor for projects, and perform other duties related to the administration of construction projects as required.

A key role of the PE is to visit the construction site, observe the work in progress, and verify it is completed in accordance with the project documents and specifications. As part of these reviews the PE should observe the inspection process and procedures performed by the field personnel to ensure that the inspectors are following the procedures in the Construction Manual and Contract Specifications. If the PE

is concerned with either the Contractor's or Inspector's performance of the work they are to provide direction on its proper performance. The PE shall keep the Assistant District Engineer (ADE) apprised of the details of the project. This may be through direct communication or through the Transportation Supervising Engineer (TSE) and Transportation Principal Engineer (TPE) depending upon District procedures.

In case of violations by the Contractor, Non-Compliance Notices (NCN) shall be issued and the matter brought to the attention of the TSE and ADE.

A list of duties is provided below as an example and is not intended to be all inclusive. Depending upon the specific requirements of the construction project(s) which the PE is assigned, the required duties may vary. Further information related to the duties listed below can be found in other sections of this manual pertaining to a specific topic.

Design Stage

- Attend design meetings and become familiar with the work and utilities involved.
- Conduct plan reviews and field visits.
- Assist other Department units so that issues are addressed through the plan review process prior to the contract being advertised.

Project Initiation

- Schedule and participate in the pre-construction meeting.
- Ensure the Contractor provides (to District Electrical Maintenance) telephone numbers of their personnel to be contacted after-hours for emergency maintenance of existing lighting and traffic signal systems.
- Provide the Inspection staff with the data, supplies, and equipment, as defined in 1-109, needed to properly inspect the work.
- Attend and actively participate in the utility meeting field review.
- Become familiar with the applicable DBE or SBE requirements as they apply to the Contract and monitor compliance throughout the project and District support staff.

Throughout The Project

- Monitor construction progress to ensure general conformance with Contract requirements.
- Ensure that project issues are resolved and direction given to the Contractor is documented.
- Intervene when a Contractor disregards direction from a project inspector. If the problem cannot be resolved, the PE may suspend the operation if conditions warrant such action. The PE must notify the ADE (and Supervising Engineer depending upon the delegation of authority) about the problem and the course of action taken. If the issue cannot be resolved by the PE, the TSE shall intervene.
- Make periodic checks of the job site to ensure that the Inspectors are properly performing their duties in accordance with Department policies and procedures. Such as:
 - Ensure that the project staff are creating and maintaining project issue folders.
 - Attend the project progress meetings. Ensure that project issues are addressed as quickly as possible and that accurate minutes are prepared for each meeting. The minutes should be prepared for distribution within 5 working days of the date of the meeting.
 - Review DWRs monthly, as outlined in Chapter 3 of this manual.
 - Periodically, review the as-built drawings (see Chapter 3)

- The system for tracking “estimated” payments shall be approved by the PE (see Chapter 3).
- Ensure that the project staff is complying with the material testing requirements for the project.
- Negotiate and support agreed prices for work to be incorporated into the project(see Chapter 6)
- Initial review of time extension requests (See Chapter 7).
- Ensure that there is regular communication and coordination among the utility representatives, Chief Inspector (CI) and the prime Contractor relative to work schedules (starting completing, etc.), sequencing of the work, and traffic control.
- Review and initial any CON-40’s noting minor overtime performed by the utility.
- Ensure that complaints from property owners that are received by project personnel are investigated and discussed with the property owner for resolution.
- Review and approve methods other than what is outlined in the Construction Manual for “partial payments.”
- If all project personnel are relieved of their duties (reassigned, etc. such as during a suspension period), it is the responsibility of the PE to make periodic checks of the job site and create weekly Diaries in SiteManager.
- Answer specific questions the inspector may have concerning Non-Compliance/Compliance Notices (NCN/CN).
- Monitor project funding and arrange for additional funds if necessary (See Chapter 9).
- Consultants (CEI)
 - Review and monitor consultant engineers to ensure that they are performing and complying with the terms of their Agreement, the current edition of the “[Information Pamphlet for Consulting Engineers](#)” and the Construction Manual.
 - Prepare Consultant Evaluations in accordance with Chapter 17.
 - Procure consultant inspection services and monitor the performance and payment activities of Consultant Engineering firms in accordance with the current edition of the “[Consultant Construction Engineering and Inspection Billing Pamphlet.](#)”

Cost Plus (Extra Work) (See Chapter 6)

- Review and approval of the labor, equipment and materials proposed for use in the performance of cost-plus work. This includes whether anyone above the grade of foreman, as mentioned in the specifications may be charged to a cost plus item (this may have to be discussed with the TSE).
- Keep the TSE informed of any extra work that will be performed on a cost-plus basis.
- Review the records periodically to assure that cost-plus payments are current and note this review by initialing the cost-plus records.
- Direct the Contractor to rent equipment when it is determined the equipment is needed to perform cost-plus work and not owned by the Contractor.
- Notify the TSE and ADE immediately if Cost Plus work has a potential to exceed \$100,000.

Change Orders (CO) (See Chapter 8)

- When the total value of a CO exceeds \$250,000, the Office of Finance – Capital Services Division and the DE should be notified in advance of the forthcoming change.
- If a Change Order is proposed from Engineering, the PE must confirm that their estimate for the cost and/or Contract time impacts are reasonable. If the cost and/or Contract time impacts provided by Engineering are not reasonable, contact Engineering to ensure proposed change is still supported.

- Review the project records regularly to identify issues with item quantities as they relate to the CO.
- For FHWA funded Contracts, determine if the proposed change order work is eligible for federal reimbursement.
- Review the CO for scope, accuracy and documentation.
- Review the completed CO package, sign all copies and forward it to the Contractor.
- Monitor the completion of the CO.

Payment Estimates (See Chapter 9)

- Review the Preliminary Payment Estimate and verify that the content of the estimate is reasonable. Pay attention to discrepancies and deductions. If the PE does not agree with the estimate they will reject it and return to the CI for revision.
- Review for approval of payment, material placed or installed for which the Contractor requests payment and for which required evidence of testing acceptability is pending.
- After their review the PE will sign and transmit the estimate to the TSE and ADE for review and signature.

Project Completion

- Notify the TSE that the project or a portion thereof is ready for a semifinal inspection. The PE will coordinate with the TSE to determine the date of the semifinal inspection and notify the involved participants.
- The PE is to notify the TSE in writing when the project is ready for Final Inspection.
- Monitor completion of required corrective work and completion of final paperwork.
- Complete form [CON-502A](#)
- Verifies that exceptions noted in the HQ Final Review from the OOC Quality Assurance Section have been corrected.

1-103C The Supervising Engineer (TSE)

The TSE assists, confers with and advises the Assistant District Engineer (ADE) on all types of construction projects. The primary duty of the TSE is the supervision of lower level employees in the administration of construction projects and consultant agreements.

A list of duties has been provided below as an example of the duties performed by a field TSE and is not intended to be all inclusive. Depending upon the specific requirements of the construction project(s) to which the TSE is assigned, the required duties may vary. Further information related to the duties listed below can be found in other sections of this manual pertaining to the specific topic.

General

- Responsible for assignment and review of the Project Engineers (PEs) work product.
- Develop and/or make recommendations for Department procedures and policies relative to Contract administration and general construction practices.

Design Phase

- Actively participate in design plan reviews, meetings, and sign off on the Engineer's construction schedule.

- Review plan review comments prepared by the Project Engineer and forward to the ADE for signature
- Review and comment on the Contractor's proposed pre-award schedule in coordination with the Office of Contracts.

Project Initiation

- Review and approve press releases, preconstruction meeting notices, installation of the construction field office.
- Actively participate in the pre-construction meeting.
- Assist the ADE in the assignment of project staff.

Throughout The Project

- Supervise the work of PEs, Inspectors and Office staff.
- Maintain continual contact with assigned PEs for resolution of construction issues and project staffing.
- Review requests for extra work, after consultation with the ADE (or TPE), advance authorization may be given by the TSE to the Contractor to perform cost-plus work.
- Review and approval of COs with minor increases and decreases in existing Contract items where no change in the Contract plans have occurred.
- Stay apprised of all details of the project and routinely visits and reviews the work of the Contractors, consultants and staff.
- In the case of a dispute on the project, the TSE should investigate, attempt to resolve, and if unresolved properly escalate the dispute to the ADE. The TSE will offer advice and assistance to the ADE during their review of the dispute.
- Review and make recommendation for COs that involve major/minor price adjustments, differing site conditions, or claim settlements.
- Sign the CO once the review is complete and necessary approvals have been received and forward it to the District Staff for further processing.
- When a Contractor returns a CO unsigned, and the Contractor has stated their objection, preferably in writing (a copy of this letter is included with the CO), the stated objections are investigated to the satisfaction of the TSE. The TSE will consult with the TPE or ADE as appropriate.
- Review and approve project estimates.

Project Completion

- When the PE notifies the TSE that a project is substantially complete as specified elsewhere in this manual, the TSE will review the project status and remaining work and, if deemed appropriate, will instruct the PE to schedule the semifinal inspection. Also at this time the TSE will make an assessment as to whether a CON 100 should be issued to stop Contract time.
- When notified by the PE that the semifinal punch list work is complete, the TSE conducts the final inspection.
- TSE will have the Certificate of Acceptance, Form CON-500, prepared and forwarded to the District Engineer for signature when the final inspection has been held, any additional work and the final cleanup have been completed, and all equipment has been removed from within the project limits.
- Authorize and sign the CON-100 which states the substantial completion date of the project.

Final Inspection by State

- Once notified that a project is ready for a final inspection the TSE reviews the status and, if deemed appropriate, arranges for final inspection with the PE and appropriate maintenance staff.

1-103D The Assistant District Engineer(ADE)

The ADE schedules, assigns, oversees and reviews the work of staff. An ADE also assists and advises the District Engineer (DE) and the OOC on all construction matters.

The following list of duties has been provided as an example and is not intended to be all inclusive. Further information related to the duties listed can be found in other sections of this manual pertaining to the specific topic.

General

- Primary role as the Department's manager-in-charge of the administration and oversight of the construction projects within a District Office
- Responsible for assignment of staff to construction projects to meet the Department's requirements for administration of the work
- Direct supervision of Supervising Engineers (TSEs) and review of their work product.
- Develop and/or make recommendations for improved construction procedures and standards relative to District operations.

Design Phase

- Participate in Design Plan reviews and meetings.
- Review plan review comments prepared by the Project Engineer and forward to Design for review and consideration.
- Review the Contractor's proposed pre-award schedule for reasonableness.

Project Initiation

- The ADE is responsible for determining the appropriate staffing level on all projects and will assign a Project Engineer (PE) and CI to oversee and take charge of each construction project.
- If the District determines that insufficient personnel are available to staff a project, the ADE must notify the OOC in order to request a consultant inspection firm.
- Participate in the pre-construction meeting and ensure that the appropriate people are present including but not limited to the Project Engineer, CI, Surveys and representatives of Maintenance, Environmental Planning, Materials Testing, Design and other Department units, when required, as well as by the Contractors, Town officials, area legislators, and utility company representatives.

Throughout The Project

- Supervise the work of the TSEs, PEs, Inspectors and Office Staff
- Maintain continual contact with TSEs for resolution of construction issues and project staffing.
- Stay apprised of all project details and routinely visits project sites to review the work of the Contractors, consultants, and staff.
- Review and approve requests for extra work.
- Authorize in writing work to be performed on a cost plus basis.

- If cost plus operations may exceed \$100,000, the ADE is to notify both the District Engineer and Construction Division Chief or Construction Administrator of the Cost-plus work
- Review and approve agreed prices for extra work.
- Authorize operations of emergency nature are required, such as hazardous potholes patching, cleaning up of damaged sand barrels, repairing damaged bridge joints, etc.,
- Review, sign, and forward payment estimates for processing.
- Authorize changes in the plans and specifications.
- Authorize the performance of specialized work.
- In the case of a dispute on the project, the ADE will visit the project, make the necessary inspections and investigations, and render a decision in accordance with 1.05.01.
- Approve and authorize “Changes in Quantities of Pay Items” under 1.04.02.
- Consult and advise the District Engineer and the OOC whether a change in the Contract constitutes a “significant change” under the Contract and seek further clarification and advice on how to proceed.
- Obtain prior approval for price adjustments that involve Article 1.04.03 or 1.04.04 from the District Engineer or from the OOC if the total adjustment is greater than \$100,000.
- Authorize the processing of construction orders whenever the following occur:
 - the Construction Order value exceeds \$150,000;
 - the cumulative value of all construction orders reaches 5%, 10%, 15% etc. of the original Contract value;
 - the Construction Order adjusts the price of an item under Article 1.04.02, 1.04.03, or 1.04.04;
 - the Construction Order addresses a potential claim issue;
 - the Construction Order grants additional time; or
 - the Construction Order contains an item change that involves a design error or material change.
- Review and approve time extensions.
- Before approving a time extension for FHWA Projects of Division Interest (PODI) , the ADE will submit by letter the time extension request and analysis to the FHWA Division Administrator for approval. Upon written concurrence from the FHWA, the ADE may act on the time extension recommendation.
- Authorize suspensions of the Contract.
- Authorize the issuance of a Construction Issue Form after consultation with the OOC.
- Authorize Type 2 changes to the Maintenance and Protection of Traffic control plan.
- Bring the following events and situations to the immediate attention of the OOC:
 - Receipt of a written notice of a claim.
 - Receipt of a demand for payment of costs which District personnel are not able to verify, such as, but not limited to, overhead.
 - Receipt of a request for extension of Contract time that, if granted, may expose the State to liability for costs incurred during or resulting from delay of project work.
 - Alleged differing site conditions and/or significant change in the character of project work, receipt of a request for the adjustment of Contract prices based on alleged differing site conditions or a significant change in the character of project work, if the aggregate adjustments would increase Contract costs by \$100,000 or more.
 - Request to modify or waive Contract requirements, as in situations in which a credit to the State should be proposed, a revision of the limitations of operations is requested, or the Contractor is proposing design revisions.

- Any situations in which the Department's action may set a significant precedent, or in which the Department's actions or inactions may have a significant effect on later or larger demands or claims by a Contractor.
- Discuss the following with the Construction Division Chief or the Construction Administrator prior to implementation:
 - Directed acceleration of a project;
 - Change, alteration, modification, or waiving of Division 1 (the General Conditions) of the Standard Specifications or any changes that may have been made to them by the Special Provisions or the Supplemental Specifications;
 - Change of the method of measurement for an item;
 - Request for a payment of home office overhead.

Project Completion

- Attend or be represented at the semi-final and final inspection of the project.
- Supervise the proper close out paperwork of the project and authorize the processing of the CON 500, 501 and 502s.
- Authorize and sign the CON 100 which states the substantial completion date of the project.

1-104 Time on Project

Inspection on projects will be continuous during any and all hours that the Contractor's forces are physically working at the project site, unless otherwise directed by the Assistant District Engineer. A sufficient number of Inspectors should be on the project at all times to properly inspect the Contractor's operations. On projects that require only one Inspector, the daily working hours of the Inspector (during the construction phase) will usually be the same as for the Contractor's forces. The Project Engineer may, with permission of the Assistant District Engineer, vary the schedule of daily hours for any Inspector when a departure from the Contractor's hours is proper procedure. The employee will be notified of changes in work schedule in accordance with the current collective bargaining Contract. The assignment of duties to the sub-inspectors is the responsibility of the CI.

Time off that can be anticipated must be arranged in advance with the employee's immediate superior. Employees who cannot report to the Project because of emergencies must call the District Office as soon as it is apparent that they will be absent or late. Formal standard reports on forms established by the Human Resources Division will be submitted promptly in all cases in which the forms are applicable.

1-105 Address of Inspectors

Changes in the CIs home address, home telephone number or Department-provided communication service are to be promptly reported to the District Office. Other inspectors assigned to the Project report this information to the CI, who advises the Assistant District Engineer. Periodically, the District staff will compile this contact information and provide an updated list to all who need to know.

1-106 Enforcing Provisions of the Contract

Inspectors cannot waive specified requirements, nor permit an inferior grade of work to be done, or allow use of unapproved or rejected materials. They are expected to give instructions, and to demand strict compliance at all times. They shall accept only such changes in plans and specifications as are authorized by the Assistant District Engineer, or above.

CI's or their sub-inspectors shall immediately advise, orally and in writing, Contractors or their representatives, when work is being done in violation of Contract provisions. The Project Engineer should be advised of the problem and any orders that were given to the Contractor. It is expected that spoken orders will accomplish results in almost every instance; however, the Inspector still needs to document these orders in a Non-Compliance Notice (see Sub-Section 1-325) and on the Daily Work Report. If a Contractor persists in working contrary to orders, the Project Engineer will intervene. If the problem cannot be resolved, inspection shall be withdrawn from that part of the work, or the Project Engineer may suspend the operation if conditions warrant such action. The Assistant District Engineer must be notified immediately about the problem and the course of action taken. The Assistant District Engineer will visit the project, make the necessary inspections and investigations, and render a decision. In the event that the Assistant District Engineer cannot settle the difficulty, the District Engineer will be called to the job, and the District Engineer's decision shall be final.

1-107 Safety

It is the duty of the CI to verify that the Contractor is performing the work in a manner that does not violate public transportation safety regulations and other requirements of the *Standard Specifications and Special Provisions*.

All Inspectors should be familiar with and the guidelines established in the Department's [Employee Health & Safety](#) webpage. Safety practices related to the environment are included in Volume 2, Chapter 1, and "Environmental Protection." In cases where the Inspector is subjected to hazards not covered by Department guidelines, the safety requirements set up for the project by the Contractor shall govern.

Inspectors will wear appropriate headgear, safety vests, and protective footwear in accordance with current Department policy. Other personal protective equipment, such as safety belts, goggles, Class 3 garments (for night work) and ear protectors, are to be used when necessary. The CI is responsible to enforce safety issues involving the sub inspectors on the job.

The Contractor is required to perform all work in accordance with the applicable safety regulations and the Contract documents. The Contractor is also required to take precautions that the Engineer directs for the protection of traveling public, all people on the project (including employees of the Contractor and Department as well as private citizens), and for the protection of property. If there is a dispute over payment related to safety precautions directed by Department personnel, the District staff and Contractor can consult the Assistant District Engineer related to Extra work.

Construction sites can be dangerous to anyone if proper precautions are not taken. Care must be taken at all times to ensure the project site/work zone is safe and passable. Special protective measures are required when working at night, in heavy traffic, at extreme heights or depths, in confined spaces, near hazardous or contaminated materials, during blasting operations, near or over water, near railroad tracks or in the vicinity of live electrical wires. Inspectors should refer to the project specifications and/or their Project Engineer for advice and guidance.

When an unsafe practice or condition exists which presents an imminent danger to the safety of the traveling public or persons on site, the Inspector will direct the Contractor to correct the situation immediately. If the Contractor refuses to correct the unsafe practice or condition immediately, the CI should order the Contractor in writing to stop the operation(s) until the situation is corrected. The Project Engineer must be notified immediately. The Assistant District Engineer should be notified as soon as possible. If the Assistant District Engineer's involvement cannot correct the situation, the District Engineer and the OOC will be notified.

1-108 Change in Travelway Clearances and Bridge Capacity Ratings

When a construction activity reduces the height clearance on a bridge or overhead sign support, reduces the lane width on any roadway or intersection, or reduces the weight capacity of a bridge, the CI is responsible to notify the supervisor of Oversize/Overweight Permit Unit 15 days in advance of the planned construction activity and inform them of the reductions and time frame that they will exist. When determining the vertical clearance restrictions, measure from the bottom of the falsework to travelway surface. Conform to Department Policy No. E&H.O.-22, regarding warning signs, when height is restricted to 14'-2" or less.

1-109 Data, Supplies and Equipment

The Project Engineer will provide the Inspector with the following data, supplies, and equipment:

Data

- Two sets of plans, including large-scale layouts of major structures
- Design Report and computations
- A copy of the Contract
- Copies of the property agreements
- Copies of utility agreements, plans, specifications, and estimates.
- Copies of all permits issued for the work

Minimum Supplies

- *Standard Specification* book and Supplements
- *Construction Manual*
- "Schedule of Minimum Requirements for Sampling Materials for Test"
- Diary and field books
- Report blanks
 - Daily Work Reports (Forms CON-134, CON-135 and CON-136) as needed
 - Pile Driving Report (Con87 and 87M)
 - Daily Report on Cost Plus (Form CON-9) or applicable electronic spreadsheet
 - Utilities forms (Forms CON-40 and CON-41)
 - Labor Wage Check (Form CON-131) and Labor Wage Check Summary
 - Request for Test (Form MAT-100) for non-SiteManager
 - Report of Test on Cylinders (Form MAT-308)
 - Rejected Material (Form MAT-103)
 - Environmental Check List-New Project Start Up
 - Project Site Environmental Inspection Report
 - Notification of Environmental Corrective Actions Implementation of 24 – Hour Rule
 - Leave of Absence Report (Form PER-4) or applicable electronic spreadsheet
- Spray paint for marking
- Hard hats
- Safety vests, Class 3 garments (for night work)
- Rain gear

Minimum Equipment

- Measuring devices
- Folding rule
- Hand level or one line level
- Rain gauge

Additional Equipment for Concrete Projects (if not supplied with field office)

- Single use or other suitable cylinder forms, plate and level
- Slump cone and rod
- Calibrated air meter
- Thermometer

Chapter 2 - Project Initiation

1-201 Project Start Up

Once a Contract has been awarded:

- It is the responsibility of the project staff to review the item material lists and arrange for deletion of material codes that will not be required. They shall also request addition of item material codes that they determine are necessary. For further responsibilities of project staff related to the maintenance of item material lists, refer to Volume 1 Chapter 4 Section 1-402A. Note: If changes to the initial testing assessment are necessary, the Inspector will notify the Project Engineer (PE) and the Division of Material Testing (DMT).
- SiteManager staff review the uploaded data in SiteManager for accuracy prior to making a project active. If the Contract contains more than one category, the SiteManager staff will discuss with the PE and Transportation Supervising Engineer (TSE) the need to keep the multiple categories. The TSE will determine if the SiteManager staff should process an administrative construction order to combine Categories with like federal funding.
- Once the field office phone number is known, this information must be provided to the SiteManager staff, who will then notify Information Systems and request data line hookup.
- The PE and/or Chief Inspector (CI) should contact the Design Project Manager to discuss important project issues, especially “commitments” that were made out of the Public Information process or the Regulatory Process. Examples would be: right of way issues, utility issues, permit requirements and any special design features. The outcome of the dialog with the designer could have tentative suggestions for the preconstruction meeting.
- Before operations are started by the Contractor, the CI should make a careful study of the plans, Contract(s), special provisions, property agreements, utility agreements, permit applications, permits, survey and design reports, and specifications for the project, to become familiar with all phases of the improvement and learn of any extraordinary features involved.
- The CI must also discuss the Project with the Designer, TSE, Environmental Coordinator, Utility Coordinator, and EEO Officer to determine if they know of any extraordinary features that may affect the Project.

1-202 Preconstruction Meetings

A preconstruction meeting with the Contractor must be held for all awarded Contracts. The purpose of the meeting is:

- To review the Contract, especially job-specific special provisions.
- To discuss Contract requirements for Contractor Quality Control, including Quality Management Plan (QMP) and if applicable, Quality Control Program.
- To discuss Project features, particularly those that may present problems.
- To discuss Environmental Permits and concerns.
- To discuss the potential problems of water pollution and soil erosion.
- To review the Contractor’s proposed progress schedule.
- To review the methods of handling traffic.
- To review sampling and testing requirements for materials to be used throughout the construction process.
- To address any of the Contractor’s questions concerning the plans and the Contract. Any problems that cannot be resolved at this meeting will be reviewed by the District Office, and the final determination will be transmitted to all concerned, and if feasible, incorporated in the written report of the meeting.

- To review the areas where acceptance of working drawing or shop drawing submittals are required before segments of work commence.
- To discuss Contract requirements for Equal Employment Opportunity (EEO), Affirmative Action, prevailing wages, On-the-Job Training (OJT) and Disadvantaged Business Enterprise (DBE) or Small Business Enterprise (SBE) Contract goals.
- To discuss the subcontracting requirements. (Refer to Volume 1, Chapter 12 for more information.) In addition, on SiteManager Contracts, a copy of the SiteManager “Contract Line Item & Category Report” is provided to the Contractor. This list is to be used by the Contractor to clearly break-out sub-contractors’ assignments by project number, item code and line item when submitting requests to sub-contract.
- To discuss the Contractor’s Quality Management Plan (QMP) submittal and Contractor quality control responsibilities.

The preconstruction meeting should be attended by the Assistant District Engineer (ADE) (or their designee), PE, CI, Surveys and representatives of Maintenance and Bridge Maintenance, Environmental Planning, Materials Testing, Design and other Department units, when required, as well as by the Contractors, Town officials, area legislators, utilities representatives and others. If there is a Notice to Contractor concerning Protection of Archaeological and Paleontological Remains and Materials, also invite State Historian from the Bureau of Policy and Planning.

See Figure 1-2.1 for the list of potential invitees. See Approved Forms folder for a suggested [Pre-Construction Agenda Form](#). Projects may vary in scope and additional units or agencies may need to be invited. On federal-aid projects, the participating agency or agencies, (Federal Highway Administration, Federal Transit Administration, Federal Railroad Administration, or Federal Aviation Administration) and the U.S Department of Labor are notified so that a representative may attend.

The District prepares a written report of meeting, including decisions made, and a copy is sent to the Contractor, as well as all attendees.

1-203 EEO Preconstruction Meeting

An EEO preconstruction meeting is held on all construction projects. The meeting, which usually precedes or follows the main preconstruction meeting, is held to review the EEO, Affirmative Action, OJT and DBE/SBE obligations in the Contract. The following people attend the meeting:

- CI,
- District EEO Coordinator,
- Office of Contract Compliance representative,
- US Department of Labor representative, and
- The Contractor's EEO officer.

The following items are reviewed and discussed in detail at this meeting:

- *EEO Segment Questionnaire*. This form is used to document minutes of the EEO preconstruction meeting.
- *Contractor's Information*, which consists of a package of various EEO-related forms and instruction sheets. This information is reviewed with the Contractor's EEO officer.

When there is an item in the Contract for Training, the requirements for OJT (On the Job Training) must be discussed at the preconstruction meeting. At this meeting it must be emphasized that the Contractor has to submit training outlines and proposed trainees before starting Contract work. (*Note: The PE must make sure the Contractor submits required training plans to the Office of Contract Compliance or their designated representative.*)

The District prepares a written report of the matters discussed and sends a copy to the Contractor and the Office of Contract Compliance.

Refer to Volume 1, Chapter 12 for more information.

1-204 Utility Meeting

A utility meeting is held by the District Utility Coordinator or designated representative prior to the start of construction, preferably at the same time as the preconstruction meeting. The District should determine the Contractor's anticipated schedule of operations by location (station or structure), so that the utility work can be coordinated with the Contractor's operation. A report listing any decisions reached is prepared for the file, with a copy to the Contractor and each of the utility companies.

At the utility meeting, arrangements will be made for a field review with the PE, CI, District Utility Coordinator, Office of Utilities Engineer, local tree warden(s), and representatives of the Contractor and utility companies in attendance. This field review must be held before construction is started. Any conflicts between the work to be performed by the Contractor and utility companies are reviewed and resolved at the field review. A field review report listing the findings is prepared and a copy is forwarded to those in attendance.

Refer to Volume 1, Chapter 13 for more information.

1-205 Notification of Contract Status

As soon as the Contractor begins operations, the CI must notify the PE, who notifies the Office of the Assistant District Engineer. The Inspector records the actual starting date of the Contract on the SiteManager Daily Work Report (DWR).

The CI prepares a Contract Status Report, [Form CON-100](#), for the prime Contractor. The form must be prepared and processed within seven days of the order to start, actual start, suspension, resumption, and completion dates. Determination of the actual dates to be entered on the CON-100 must be coordinated with the District Supervisory staff as described elsewhere in the manual. The District distributes the signed form in accordance with the list on the form.

Start and completion dates for utilities must also be sent to:

- Manager of Fiscal and Special Projects, and
- Transportation Utilities Engineer.

Notification should be sent to both of the above within seven days of effective completion date so final audits can be performed.

Figure 1-2.1 Preconstruction Meeting Invitees

Invitee (If Applicable)	Pre-Con.	Comments
FHWA – Division Administrator	X	F.A.P. PODI Highway Projects
FRA – Division Administrator	X	F.A.P. Rail Projects
FAA – Division Administrator	X	F.A.P. Airport Projects
U.S. DEPT. OF LABOR – Asst. District Director	X	F.A.P. Projects (CA 16-96)
STATE DESIGN – Engineering Administrator, Manager, Principal Engineer (Highway, Bridge, Facility)	X	cc: Engineering Administrator on all Semifinal Inspection Reports (CA 25-96)
CONSULTANT DESIGN – Engineering Administrator, Manager, Principal Engineer (Highway, Bridge, Facility)	X	cc: Engineering Administrator on all Semifinal Inspection Reports (CA 25-96)
PROPERTY AND FACILITIES SERVICES – Director	X	Facilities Construction
OCCUPYING UNIT / AGENCY – Representative	X	Facilities Construction
OFFICE OF CONSTRUCTION – Administrator, Manager, TSE (Facilities)	X	Facilities Construction
TRAFFIC ENGINEERING – Manager	X	
ENVIRONMENTAL PLANNING – Director	X	
CONTRACT COMPLIANCE – Director	X	
OFFICE OF MAINTENANCE – Maintenance Operations Principal Engineer	X	All Projects involving Traffic Signals
MAINTENANCE – District Manager	X	
ELECTRICAL MAINTENANCE	X	Maintenance of illumination responsibility during project
BRIDGE MAINTENANCE	X	
BRIDGE SAFETY	X	Bridges and New Overhead Signs (CA 6-96)
DISTRICT CONSTRUCTION – DE, ADE, PE, PE (Surveys), TSE, PE, Chief Inspector, Environmental Inspector, EEO Officer	X	
TOWN/CITY	X	
LOCAL AUTHORITIES	X	Facilities Construction
UTILITIES	X	
CONTRACTOR/SUBCONTRACTOR	X	
PAVEMENT ADVISORY TEAM	X Pre-pave	Also Final Pavement Evaluation required – 2,500 tons or greater surface course

<u>STATE HISTORIAN FROM THE BUREAU OF POLICY AND PLANNING</u>	X *	* If there is a Notice to Contractor concerning Protection of Archaeological and Paleontological Remains and Materials
--	-----	--

Chapter 3 – Project Documentation***1-300 General***

Federal participation in the cost of the construction is contingent upon documentation of the project. Federal agencies require the state agencies to develop and maintain a standardized system of documenting the work and payments made. To fulfill this requirement, the State of Connecticut Department of Transportation (Department) developed a standard system of recordkeeping.

The Department's standardized system for recording and documenting conditions and activities related to the construction work is presented in this Chapter. Project records must be accurate and complete. They may be subject to detailed review and audit by State and Federal personnel at any time, even years after project completion, and they may also be required for settlement of claims or disputes between the Contractor and the State. Unless there is a specific requirement, records may be maintained in paper or electronic form.

The Inspector is responsible to ensure that all forms and reports documenting the contractors work, as well as those that may be required by other units of the Department and State and Federal agencies, are accurate and complete. Notes and explanations should supplement the records, if needed, to make the records as clear and complete as possible. A sample list of project records is provided below (depending upon the specific project other project records may be necessary):

- Contract Documents (plans, specification, etc.)
- Inspector's Diary
- Inspector's Daily Work Report (DWR)
- Project Volumes (and other documentation supporting Contractor payment)
- Project Correspondence (including Email)
- Meeting Minutes
- Concrete Base & Pavement Inspection Report (Form CON-135)
- Base & Bituminous Concrete Inspection Report (Form CON-136)
- Requisitions and Receiving Reports for State-furnished materials
- Requests for Material Tests (Form MAT-100)
- Report for Test on Cylinders (Form MAT-308)
- Report of Rejected Materials (Form MAT-103)
- Cost Plus Forms
- Pile Driving Records (Form CON-87)
- Special orders/directives to Contractors
- Non-Compliance/Compliance Notices
- Labor Wage Check (Form CON 131)
- Contract Status (Form CON-100)
- Certified Payrolls
- Construction Orders
- Environmental Forms and Reports
- DBE/SBE documentation

The District office maintains certain records for each project, such as the official correspondence file, as well as all correspondence addressed to the District based staff.

The Inspector is responsible for the establishment and maintenance of the project site filing systems and for project record organization at the field office. All correspondence received by the field staff as well as other project information must be maintained in an organized manner.

The file structure should be established at the onset of the project and reviewed by the Project Engineer (PE). The size of the file system will vary depending on the size and complexity of the project. Larger projects or those projects using an electronic database will likely use a more complex numerical sequential system. Sample filing systems for both smaller and larger projects are included in Appendix C, Table 2.

The minimum retention period for project-related records is seven years after the project's Certification of Acceptance of Project (Form CON-501) is issued or three years after final federal payment, whichever is later, providing there is no pending litigation. (Note: The date of final payment by the Federal Highway Administration or other federal agency may be years after the date of acceptance by the State Department of Transportation. Therefore, the appropriate staff responsible for record retention must follow the established procedures for destruction of records before disposing of the project records).

1-300A Electronic File Naming Convention

Although records may be maintained in paper or electronic form, the Departmental preference is for electronic documentation moving forward. The following naming convention shall be used for all Email subject lines and electronic file names to aid in the filing and retrieval of the electronic files (calculations, correspondence, reports of meetings, scanned correspondence, etc.):

PPPP-PPPP_YYYYMMDD_ BriefSubjectName.file extension (pdf, xls, etc.)

PPPP-PPPP = Contract or Project Number (as appropriate)

YYYYMMDD = Year Month Day

BriefSubjectName = subject that file documents – see below for examples

Example:

- 0170-2829_20110709_MatlCerts.pdf
- 0200-0363_20160711_earth volume wall 101.xls
- 0200-0363_20160711_pervious volume bridge 05879 abutment 1.vce
- 0200-0363_20160711_out of section rock survey data from DOT survey Sta 20+50 rt to Sta 20+65 rt.txt
- 0170-2829_20161012_John Doe Contractor request for adjustment of Item 0202003.pdf

1-300B Use of Electronic and Digital Signatures

Digital/electronic signatures are to be used as much as possible to reduce paper copies and reduce correspondence processing time consistent with the Department's e-Construction initiatives. Digital/electronic signatures should be the primary method used, but handwritten signatures are still allowed.

The terms electronic signature and digital signature have the following meanings:

- “Electronic signature” describes a signature produced by electronic means within a software program such as Bluebeam Revu, Adobe Acrobat, or other.
- “Digital signature” describes a third party verified electronic signature.

A digital signature qualifies as an electronic signature, but when the term electronic signature is used it is defined as a signature without third party verification.

The majority of the documents used by Construction Division staff related to construction projects, known as the “List of Standard Correspondence” can be found in Appendix C. This list identifies the signature type required for each document. Any intra-Department correspondence not listed may be signed using an

electronic signature. For external correspondence not listed, staff should consult with the Assistant District Engineer (ADE) or District Engineer (DE) to determine the appropriate type of signature. Any correspondence not addressed in the “List of Standard Correspondence” should also be brought to the attention of the Office of Construction (OOC) - Technology Section for evaluation.

For correspondence requiring digital signatures, Department staff will use DocuSign or other third party verified digital signature solutions approved by the Construction Administrator. For correspondence that can be signed using an electronic signature, personnel are required to follow the procedures established in the “Electronic Signature Guide for Internal Documents” located in ProjectWise within the 04.1 – Construction Libraries > 04.100 – Manuals, Guides and Training Videos folder.

1-301 Engineering Generated Project Documents

The Office of Engineering is required to store engineering generated project documents in ProjectWise for ease of access and record retention. These documents include, but are not limited to project plans, specifications, and design initiated change orders.

For a listing of folders and a description of their contents, refer to section 2 of the Construction Division ProjectWise Document Storage and Usage Guide located in Appendix E of this manual or the Digital Project Development Manual (DPDM) maintained by the AEC Applications Unit.

1-302 Field Records

This section outlines general principles to be employed in the creation of the project records:

- The records should be complete, and the information should be presented in such a way that a person not familiar with the project could understand what happened and what the conditions were.
- Willful falsification, distortion or misrepresentation of any facts related to the Project is a violation of State and Federal law.
- The Department’s official record of the work will be the SiteManager DWR along with supporting documents. Any exception must be approved by the Construction Division Chief.
- **Through the user’s acknowledgement of the Department’s Computer Use Policy and the SiteManager certification statement, the user is certifying that information entered is accurate to the best of their knowledge. The user is responsible for any information entered under their user name and password. Passwords shall not be shared.**
- Project Volumes will be filed as follows:
 - Volume I – Diaries and Inspector's Daily Work Reports(DWR) (only required for non-SiteManager projects)
 - Volume II – Contract Items (only required for non-SiteManager projects)
 - Volume III – Computations, Etc.
 - Volume IV – Miscellaneous Contract Data
 - Volume V – Book 1 Bound Field Books, Book 2 Unbound Notes, Field Reporting Forms and computations
- The preparer’s full signature and printed name, as well as the date and project number are required on all hand written records, including documents scanned except as noted herein.
- If a volume consists of more than one book, the second book in the series should be designated “Book 2” (for example, “Volume III, Book 1;” “Volume III, Book 2;” and “Volume III, Book 3”). On minor projects all volumes may be contained in one or two binders, as the number of pages’ dictates. Each volume must have an index page that lists the contents.

- Erasures or whiteouts are not allowed on paper documentation prepared by project personnel. If an error is made, the incorrect figure, item, or statement should be crossed out and initialed. The correction may be written above the error or made elsewhere. If the correction is made elsewhere, a reference to the correction must be recorded next to the crossed-out and initialed error.
- Electronic forms, spreadsheets, etc. should be maintained in the same fashion as the bullet immediately above this one. If an error is made in a calculation that supports a payment, the sheet or form must be retained. A second file must be created and associated with the corrective payment (reference from the corrective DWR) so that there is support for both the miscalculated payment and the corrective payment.
- In general, project records are to be retained in the field office. The inspection staff should make reasonable efforts to ensure that the paper portions of the project records, especially those supporting payments are stored in a fireproof cabinet.
- Weigh tickets and delivery tickets (originals) for materials that are not paid by the ton should be collected and kept in the project records for reference.
- Weigh tickets for materials that are paid for by the ton must be collected as support for the payment. Inspectors are responsible for collecting the tickets, noting related information on the ticket and signing them as the material is installed. The tickets are to be kept in a binder and should be grouped in chronological order, limiting the binder to tickets for one item. The location of the weigh ticket(s) must be referenced in the payment DWR i.e. 3 weigh tickets located in Delivery Ticket Book 1 – Processed Aggregate Base. Refer to other sections of this manual for information that should be noted on the tickets. Weigh tickets shall be tallied. For pavement projects, the tally sheet shall be bound together with the paving report and ticket group used for the paving stationing.
 - On the tally sheet, provide at a minimum the following information:
 - Project Number, DWR and Date
 - Station location with range
 - Material type
 - Preparer’s printed name and signature with the date
 - Reviewer’s printed name and signature with the date
 - Computer program which generated the tally

1-302A Field Notes

Field notes are intended for situations when mobile devices are unavailable or not practical to document the work in SiteManager.

Field notes used to prepare the DWR can be handled in one of two ways:

- Bound Field Book – If a Bound Field Book is used to record information gathered in the field, it must be used for only one Inspector on one project and retained with the project records. An index (Volume V Book 1) shall be created to log the bound field books.
- Unbound Field Notes and Forms –Unbound field notes and forms that do not accompany delivery tickets (originals may be scanned and/or attached to the SiteManager DWR). Unbound Field Notes documented on paper must be included in the Volume 5, Book 2 in paper form. As explained earlier in this section paving reports and other forms that are associated with operations involving delivery or “weight” tickets should be filed with the weight tickets and referenced from the SiteManager DWR. Refer to Section 1-307).
 - The labeling and content requirements for the Bound Field Books, Unbound Field Notes and Forms, as well as the Volume 5 book 1 and 2 are explained in Section 1-307 of this chapter.

- Proposals to use other means for recording field notes such as mobile devices and electronic forms must be pre-approved by the OOC Technology Section Principal Engineer.

1-302B Use of SiteManager

As part of the standard operating procedures, all projects should use electronic DWRs for documentation of the work.

If the DE determines that it is beneficial for a project to use paper based DWRs, the DE should inform the OOC Division Chief so that the appropriate individuals receive notification.

1-302C Measurements and Calculations

Field measurements and calculations must be maintained as part of the project records. Measurements supporting payment, whether field measurements or plan takeoffs, must be performed in accordance with the Method of Measurement and Basis of Payment from the applicable Contract item. Calculations may be performed manually on paper or computed through the use of software. There are certain requirements for each method. Documentation of the work location (station and offset), field measurements, plan sheet number(s), structure number, should accompany calculation documentation, or be recorded with the SiteManager payment.

Documentation:

The standard format for documentation of the persons involved in field measurements and calculations is:

- For recorded sketches, measurements, etc. in the Volume III, the person who recorded the sketch, measurement, etc. is to sign and date the page using the following or similar format:

Prepared by and/or Measured by: (signature) _____ Date _____
 (printed name) _____

- For recorded sketches, measurements, etc. in the Volume V, see section 1-307 of this chapter.
- For measurements recorded in SiteManager performed by the owner of the DWR, the user should enter the field measurement in the item remarks field in the following manner “FM: *The measurement and unit*”. (Note: This method is not necessary if a field book or loose field notes are utilized in conjunction with the Volume V to record field measurements in which case the “remarks” field would reference the Volume V book).
- For measurements recorded in the SiteManager DWR that were measured by others, record the name of the inspector(s) who took the measurement(s) and date(s).
- For calculations documented on paper, the person who performed the calculation and the person who checked it are to sign and date every page. Use the following or similar format:

Computed by (signature) _____ Date _____
 (printed name) _____
 Checked by (signature) _____ Date _____
 (printed name) _____

- The person(s) performing measurements, computations and checks using software must be documented through the reports whether stored in electronic format or on paper (See detailed requirements below).

Software Utilization for Measurements and Computations:

This section outlines general principles to be employed when using software to calculate quantities and document the work.

The following software programs are approved by the OOC for use by project personnel for performing measurements and/or computations when appropriate and when the conditions outlined in this section are met:

- Micro-station CAD*
- Inroads CAD*
- Microsoft Excel (Spreadsheets)*
- Bluebeam *
- GPS Companion software *

*The users must meet certain qualifications, the reports must contain certain information, and the computations and the data entry must be checked, as explained below, to verify that the software is performing as expected, and that there were no user errors. The following guidelines shall apply:

1. If Micro-Station, Inroads or other CAD programs are used by another DOT unit and the information is supplied to the project staff, it is the responsibility of the unit supplying the information to the District to verify that the software performed correctly and that the data source is reliable and appropriate for the computation. The project staff is responsible to perform a cursory review to verify that the supplied information is generally as expected and that the documentation supplied conforms to #3 and #4 below.
2. If the project inspection staff or the office staff (consultant or DOT) use software programs, the following shall apply:
 - For Micro-station and Inroads, or other CAD programs the user must have previous experience utilizing the software and be proficient in its use.
 - For Microsoft Excel, there are no specific qualifications other than the knowledge of the computations and formulas being attempted.
 - For Bluebeam, the user must comply with the Connecticut DOT Bluebeam guide for measurements and computations located in Appendix E.
 - GPS or RTS Companion software will only be used on projects utilizing the GPS/RTS equipment for inspection. Standard practices and requirements are detailed within the [*CTDOT GPS/RTS Inspection Guide*](#).
 - Data Entry checks:
 - For spreadsheets and other software requiring manual data entry, a minimum of 10% of the data entries must be randomly checked by comparing the field measurements, take offs or other source data to the entries in the software (not applicable to GPS/RTS data). The verification of the checks should be documented through the PDF report/file using commenting tools.
 - Examples:
 - For Rebar, check the data to make sure the bar types, sizes, and lengths agree with the approved shop drawings and field notes. (The bar type is obtained from the Bar Mark.)
 - For cost-plus reports, check the labor, material, and equipment data to make sure the information agrees with the original report created in the field, certified payrolls, receipted bills, and “Rental Rate Blue Book” worksheets.

- For excavation calculations, check the data to make sure entries agree with plan sheets and survey data.
- Program or spreadsheet checks to ensure that the output is as expected:
 - If an OOC approved form is used, the calculations have been checked prior to approval and therefore if changes are not made to the “approved form” the field staff does not have to check to see that the formulas of the program are correct.
 - If an “approved form” is not used, the calculations (formulas) must be verified by picking a minimum of two sets of data (field measurements, take offs, etc.) and manually performing the calculations that are computed by the software (does not apply to GPS/RTS companion software). Documentation of the manual calculations for checks must be incorporated into the electronic or written project records and referenced from a zero payment in SiteManager for the subject item.
 - GPS/RTS hardware and companion software generated measurements and computations require different methods for review. (1) verify that the proficiency of the person(s) using the GPS equipment and companion software has been documented by the GPS workgroup and copies of the documentation is in the project record; and (2) the reports and other output for precision reported by the GPS/RTS unit are within the tolerances specified in the *CTDOT GPS/RTS Inspection Guide*. In addition the user must make a general assessment that the information reported is as expected.
 - Specification and documentation requirements in #3 & #4 below must be followed.
- 3. The following requirements apply to all measurements and computations performed with hardware/software:
 - The method of measurement and computation must comply with the Contract specifications.
 - The data source, scale, etc. must be incorporated into the reports. For example:
 - If a PDF is the source of the data; the scale, software, method of calculation, etc. used must be recorded and checked.
 - If quantity information is supplied by another DOT unit or design consultant, the survey information, hardware and software used, method of calculation, and files specified in 4 below must be supplied by the party for the project personnel to perform the cursory review and incorporate into the project records.
 - If GPS survey data and related software are used, the procedures used to acquire the data and the method of calculation must be documented and checked.
 - The person(s) performing measurements, computations and checks using hardware/software must be documented through the reports, whether stored in electronic format or on paper, in accordance with the OOC Guide for Documentation of Computations, located in Appendix E.
 - The person checking a computation generated with approved software must be documented on the PDF output or report using an Electronic Signature in accordance with the OOC Guide for Documentation of Computations, located in Appendix E .
- 4. The Electronic files must be stored and backed up in a consistent manner. The source data, each program file, and any computer-generated reports must be backed up to ProjectWise in accordance with *Construction Division ProjectWise Document Storage and Usage Guide* located in Appendix E. If ProjectWise access is not available, contact the OOC Technology Section for guidance. The following must be produced /retained (as noted in the last sentence) and referenced from the payment DWR for each computation or series of computations:

- One copy of the input and output is to be retained in the program format.
- An additional copy of the input and output data shall be generated as a PDF file (report) and retained.
- Survey data files must be supplied in the program file and in a .TXT format and retained.
- If the use of back-up media other than ProjectWise storage is approved by the OOC Technology Section, it must be labeled with the date, project number, and subject at a minimum. It should then be retained with the project records.

1-303 Diaries and Inspector's Daily Work Reports

Daily Diaries and Daily Work Report (DWR) are entered and maintained in SiteManager. The information in this manual outlines the content and general requirements related to the Diary and DWR. The Site Manager User Guide found in Appendix A of this manual, outlines the proper locations (fields) to enter the data into the SiteManager system.

The DWR and attachments thereto, in conjunction with the Daily Diary are considered the source documents for project documentation. *The intent of the Diary and DWR is to document the daily activities and occurrences related to the project, record payments, document field conditions, and meet the requirements for the federal reimbursement. These reports when completed properly provide valuable information in the event of contractual disputes and legal actions. To this end it is important that the records be complete, up to date and maintained in a consistent manner throughout the Department.*

1-303A Diaries

The SiteManager Diary is entered by the Chief Inspector (CI) or Resident Engineer (RE) to track time (i.e. elapsed days, calendar days), to authorize the DWR entered by inspection forces and to record pertinent information regarding the project.

Each Diary should contain a brief summary of the field operations covered by each inspector correlated to the inspector's name. The diary should also note the work hours of project staff that do not fill out a DWR for that day, any official visitors to the project and the CI's/RE's activities for the day. If contractor activity does not necessitate that a DWR be completed for a given day, then the Diary should include a synopsis of all conditions and activity related to the administration of the Contract. If the CI is the only person assigned to the project site and making out a DWR, then the above noted information may be contained on the DWR and the Diary referenced to the DWR.

The CI or RE is responsible for authorizing DWRs and making sure the Charge Day is correct on their Diary. No one below the level of CI (both Consultant and State personnel) is authorized to approve Inspector's DWR's.

Diary Entry:

- From the time the CI or RE is assigned full time to a project until the Notice to Proceed date a Diary should be entered weekly to document events and the activity of the inspection staff relative to the project. Time will not be charged until the Notice to Proceed Date.
- From the Notice to Proceed until the Substantial Completion Date a Diary is required for each Calendar Day including winter shut-down periods. It is important the CI pay close attention to the Charge / No-Charge function of the Diary to accurately record contract time. For example, during winter shut-down, the diaries would be coded as no-charge if the winter days do not count per the Contract.
 - In the case of Emergency Declaration, each Calendar Day would be considered a "Charged" calendar day.

- During a full suspension of the work, Diaries may be filled out daily or weekly as warranted to document activity pertinent to the contract.
 - If all project personnel (up to and including the CI and/or RE) are relieved of their duties (reassigned, etc.), it is the responsibility of the PE to make periodic checks of the job site and create weekly Diaries in SiteManager. The Diaries must contain all ongoing information, discussions, meetings, etc., regarding the suspension period and job-site changes.
 - If the project is under suspension, it is important that the responsible party (CI or PE) inventory materials stored and equipment left on the job site and attach a list to their Diary or DWR.
- From the Substantial Completion Date until the final punch list is completed, a DWR and Diary are required when there is contract activity or when a payment is made. If there is no contract activity, a weekly Diary should be filled out to document events and the activity of the inspection staff relative to the project. Time will not be charged after the Substantial Completion Date. (If the inspection staff is relieved of full time duty prior to the final Punch-list being completed the weekly Diary is not necessary).

1-303B Daily Work Report (DWR)

The SiteManager DWR and supporting information is the official record of the contract work performed on the project. The Inspector should create a record of the work that is clear, concise, and complete.

A DWR is required when there is construction activity whether performed by a contractor, utility, DOT Maintenance or any other entity. A DWR is also required to make contract payments. A DWR should be entered into SiteManager daily by all field personnel engaged in the inspection of contract work.

The SiteManager DWR may be supplemented by field reporting forms when applicable. Most commonly this occurs for operations involving cost plus, bituminous concrete placement, concrete paving, processed aggregate base and other operations that require extensive field documentation to be performed at the time of the operation. The field reporting forms may be completed electronically or scanned and saved to ProjectWise, in accordance with the Construction Division ProjectWise Document Storage and Usage Guide and section 1-302C herein or attached to the appropriate section of the SiteManager DWR. The paper copy of the field reporting form should be retained in the appropriate volume or folder and referenced from the DWR. For example, the bituminous concrete paving report will be kept with the bituminous concrete paving (or weight) tickets and cost plus documentation is kept in the Volume 3.

If the Inspector is not using a mobile device to complete the SiteManager DWR in proximity to the work location due to site conditions, the Inspector will use either a project-specific bound field book, or unbound field notes to record notes to allow them to recall the occurrences, conversations, field measurements, etc., at the time of inspection. The Inspector will utilize the notes to create the SiteManager DWR. The bound field books or unbound field notes shall be retained with the project records as outline later in this chapter.

DWR Creation and Entry:

- **It is critical that the project staff enter the information for the DWR in the proper fields of SiteManager.** This section outlines the information required for the DWR. The Project staff shall follow the direction in the SiteManager User Guide updated for electronic Diaries and DWRs, for proper entry of the information into SiteManager.

- If the project is such that an Assistant CI or Consultant Field CI is employed they are required to fill out a DWR to document their daily activities. The DWR prepared by the Assistant CI must include information concerning important discussions with the Contractor; incidents on the Project; discussions with designers, utilities, or public officials; meetings attended; discussions and directions given to inspectors and contractors; any other information necessary to document the events that occurred on the project. If the Assistant CI performs inspection duties as well, the details concerning the work personally inspected shall also be included on the DWR.
- Project staff assisting another inspector with concrete or bituminous concrete placement inspection, are not required to prepare a DWR. However, these inspectors must be listed on the DWR of the lead Inspector overseeing that operation.
- The minimum information that should be documented by the Inspector is outlined below: (*The appropriate locations to enter the information are outlined in the SiteManager User Guide*).
 - The SiteManager DWR should include: The Contractor or subcontractor performing the work; weather conditions; location of work; workforce and equipment involved; hours worked; signing patterns; description of the work; items that pay for the work; status of the operation; if work does not appear to conform to the plans and specifications, it should be noted on the DWR and a Non-Compliance Notice issued (Refer to Section 1-311); conversations specific to the project or work items; possible extra work; environmental notes; hours of the inspector; field measurements; meetings attended; official visitors; incidents on the project; and any other information pertinent to the work.
 - The description of the Contractor's work that the Inspector has observed should answer the following questions: Who, What, When, Where, How, How Much, is it complete or ongoing? This information will be entered into the Item Field of the SiteManager DWR. (*Outlined in the SiteManager User Guide*).
 - If work is ongoing, but not complete and acceptable, a zero quantity must be entered into SiteManager. If the operation involves multiple work items, the Inspector may choose one that is most representative of the work to input the information.
 - See the SiteManager User Guide for proper entry of a Non-Compliance/Compliance Notice in the SiteManager system. A copy of the notice should be scanned and attached to the SiteManager DWR.
 - If the Contractor alleges or requests extra work for an operation, it should be noted and the labor, materials and equipment recorded.
 - Lane closures should be documented by identifying the approximate beginning and ending locations, which lanes are closed, time closed and time opened to traffic.
 - Computations should be documented by using the Volume III or the Volume V (book 2) numbering systems or by organized electronic storage. If computations are completed using electronic means, the data utilized, computation, checks, and storage must comply with section 1-302C.
 - Discussions with contractors, property owners, and governmental agencies, or others pertinent to the project should be noted.
 - Meetings attended should be noted with a brief description of topic.
 - When the Contractor's person responsible for density sampling/testing is on the project site it should be documented on the Inspector's DWR.

1-303C Review of DWRs

This section outlines the routine reviews necessary by CIs, REs and PEs during the normal course of business. It is the responsibility of the CI(s) to review and approve all inspectors' DWRs including attached

sheets and forms. The CI should ensure that issues identified during their review, or a review performed by others, are addressed. They should also make efforts to ensure that similar issues do not occur in the future.

The following checklists have been created to standardize the review of DWRs by the noted individuals:

Review by Chief Inspector or Resident Engineer:

- Written supplementary sheets, forms, etc., prepared by inspection staff, must be referenced from the Diary or DWR, as outlined Sections 1-302 or 1-303.
- If field measurements and/or calculations are documented using the Volume V Book 2, the DWR need only state, “see Volume V Book 2 Date”.
- The DWR records the minimum information as outlined in Section 1-303B.
- Possible cost-plus work is documented with a description of the location and work, as well as labor hours, equipment hours, and amounts of material used for each contractor’s operation.
- Lane closure information includes the location, lane(s) closed, direction etc.
- The DWR references supporting documentation. If a reference in the DWR “remarks” field to the supporting back up documentation in Volume III is incorrect the following steps should be taken: A note should be added to the Volume III Summary sheet which was first referenced to from the DWR, explaining the error and referencing the correct Volume III Book number and page number).
- The computations referenced from the DWR are checked within a reasonable timeframe. For a large project with multiple inspectors the computations should be checked prior to accepting the DWR. For projects staffed with one or limited staff the computations may not be able to be checked prior to acceptance of the DWR but should be checked in a timely manner and any corrections made should reference the original computation and DWR.
- Sketches and/or measurements are referenced in accordance with the guidance of this chapter.
- Work performed by others (i.e. Utilities, Maintenance, Municipalities, or others) is documented by hours, personnel, equipment, and description of work.
- Project and other DOT staff assisting with inspection of operations are listed on the lead inspectors report (include hours of work).
- Notes regarding discussions with contractors, property owners, governmental agencies or others, adequately document the conversation and actions taken.
- The written project records reviewed do not contain erasures or white-outs. Mistakes should be lined out and initialed.
- Meetings attended are noted and a reference is made to location of the minutes of meeting.
- Official visitors (i.e. State or Town officials, CTDOT supervisors or managers, and FHWA, FTA, FAA, utility representatives, Record Examiners, Auditors, DEEP, AMTRAK, etc.) are noted and conversations detailed.

If there are issues identified by the review, the CI or RE shall confirm that the corrections are made prior to acceptance of the DWR(s) and discuss the issues with the Inspector to avoid recurrence in the future.

Review by Project Engineer(PE):

The PE should review the work of the inspection staff as soon as possible and periodically thereafter to ensure the project staff understands the procedures, responsibilities and documentation requirements related to their position. The frequency, timing of reviews and subject matter reviewed will depend on the project and the personnel assigned. It is recommended that for the first few months of the project, the PE should review a minimum of three days of DWRs and Diaries per month (up to five DWRs per day reviewed). The review should focus on inspection procedures, content and documentation. As a benchmark, a minimum of 50% of the DWRs reviewed should contain item payments. Cost-plus items and items with

computations in the Volume III should also be reviewed. The items checked should vary from month to month. All documentation supporting payment made on the DWR should be examined whenever possible.

The PE must document the reviews performed. The PE should enter a DWR in the SiteManager system for the day of the review. The DWR should identify the items, DWRs, Diaries, and documentation reviewed and includes an accompanying statement of whether or not each met the requirements and any corrections required.

The CI will ensure that the corrections are made and notify the PE when complete. The PE should check the following month to make sure the same issues are not repeated.

The following checklist has been created to standardize the review of DWRs by the PE:

- The Diary (CI or RE) lists Inspectors assigned to the project and the work operations covered or the administrative functions performed by each Inspector.
- The Diary is kept up to date.
- The DWRs are being kept up to date for all work activities.
- The DWRs are clear, concise and adequately describe the work performed.
- The payments made on the SiteManager DWR have the proper references to calculations and field measurements.
- Quantities of material tested are consistent with quantities being paid.
- Field measurements are being taken and documented in accordance with the contract documents and specifications.
- Corrections are made using the “strike out” method on written forms.

For single inspector projects, the PE will also check the items noted on the CI/RE review checklist, listed above.

1-303D Daily Paving Reports

The Inspector in charge of a paving operation is required to enter a SiteManager DWR and make out a Concrete Pavement Inspection Report (Form CON 135) or a Base and Bituminous Concrete Inspection Report (Form CON 136) as appropriate. These forms shall be kept in the delivery ticket folder. *Refer to Volume 2, Chapter 7, “Concrete Pavements,” for guidelines to complete Form CON-135, and Volume 2, Chapter 6, “Bituminous Pavements,” for guidelines to complete Form CON-136.*

1-304 Vacant (Previously Volume II)

1-305 Volume III - Extensive Calculations

Contents: The Volume III numbering system is organized by item and is intended for items requiring extensive calculations and/or measurements. The Volume III media may be a paper, electronic, or a combination of both. Unless otherwise approved by the PE, the following items must be incorporated into the Volume III:

- Cost-Plus records
- Drainage items (Except items starting with 0286, 0586 or 0686 - All Inclusive Drainage items)
- Trafficperson items

Other items may be incorporated into the Volume III at the discretion of the Inspector or PE. Examples of items that require extensive calculations include, but are not limited to, Earth Excavation, Structure Excavation, Removal of Existing Masonry, Concrete for Structures, other excavation items, deformed steel bar items, electrical items, and Turf Establishment. However, it is not recommended to document every contract item using the Volume III since there are alternative methods that better suit less complex calculations such as the Volume V or the DWR.

General Organization: The Inspector and PE should decide which items will be documented using the Volume III or Volume V books. The books should be set up in advance of the work. At the same time, the Inspector and PE should also decide which calculations will be performed utilizing software, and ensure that the project staff fulfills the documentation, verification and backup of the electronic records as outlined in this chapter.

The Volume III Books should be assembled and maintained according to the following requirements:

- When setting up the Volume III Books it is very important to anticipate the amount of documentation necessary for each item and allow ample room for expansion. Consideration should be given to the size and nature of the project.
- An Index of Volume III books should be created to keep track of the number, and contents of each Volume III book. This book may also contain the Master Summaries for the project if they are required as explained later.
- The cover of each Volume III book must list the project and volume number as well as the individual book number. Do not duplicate book numbers. The standard numbering is, “Volume III, Book 1,” “Volume III, Book 2” and so on.
- If there is a need to coordinate topics or expand a book then letters may be utilized in addition to the book numbers (Example: “Volume III, Book 1;” “Volume III, Book 1A;” and “Volume III, Book 1B.”)
- For contracts with many books subtitles should be used to identify the content of certain books (i.e., “Volume III, Book 3, Drainage Book.”).
- Volume III books must be bound and contain an index.
- Volume III summary sheets are required. The summaries may be maintained on paper as the first page for each item or as an alternative, in SiteManager by using the SiteManager Work Item Detail Report (generated only as needed). There are two instances when the use of the SiteManager Work Item detail may not apply:
 - Drainage books (Specific guidance is provided later in this chapter relative to set-up of the drainage books).
 - If paper summaries are used for items instead of using SiteManager then a master summary book is necessary in addition to the item summaries if calculations or backup is located in multiple locations. The Master Summary summarizes all locations where item payment backup is located.
- Only one page number should be assigned to an item. If additional pages are required to document computations, the pages should be assigned the same number with a consecutive letter designation (example: “Class A Concrete, Page 23,” “Class A Concrete, Page 23A,” and “Class A Concrete, Page 23B.”)
- If an item has a very large original bid quantity and/or it is expected that the back-up documentation to support the payments will be extensive, it is suggested that the item have its own book number. Many times Cost-Plus falls into this category.
- When estimated payments are used, a record of approval by the PE must be documented in the Volume III. See Section 1-912 for further explanation and requirements.
- Refer to Section 1-305A Drainage Books, 1-305B Structures, Mainline and Roadway, and 1-2005 Trafficperson for additional requirements specific to those records.

- Any questions regarding Volume III contents or organization should be brought to the attention of the PE who may also contact the OOC Quality Assurance Section (Records Examiners).

1-305A Drainage Books

In addition to the Content and General Organization requirements at the beginning of this Section, the following guidelines are to be utilized when setting up Volume III Drainage books:

- For this topic a drainage section consists of the structures and culvert or pipes in between them (i.e. catch basin to catch basin, catch basin to outlet).
- When SiteManager is utilized for project documentation, the Master summary noted in the next bullet is not necessary. The Site Manager Item Report may be generated at any time for reference therefore a printed copy does not have to be maintained in the Volume III. The SiteManager item report does not replace the left and right hand pages of the drainage book. They provide specific information that must be maintained in the Volume III or by alternative means.
- The Volume III drainage index master summary lists the drainage sections, as they appear in the drainage books. It summarizes the items and quantities for each system. A total must be shown for each item.
- For projects without All Inclusive Drainage items (items starting with 0286, 0586 and 0686), after the summary in a drainage book the pages are paired by left hand and right hand pages. Only one drainage section is allowed per set of pages. The right-hand page of the drainage book shows the plan sketch and the computations for the drainage section. The left-hand page lists the items and quantities pertinent to the section shown on the accompanying right-hand page. Quantities are totaled at the completion of the section or defined portion thereof. The Site Manager DWR should reference the left hand section summary page when a payment is made.
- For projects with All Inclusive Drainage items, extensive calculations for rock and unsuitable material excavation should be documented in the Volume III drainage book. The format for the drainage book should be the same as detailed in the bullet above with the exception that the pages are not limited to one section of drainage per page.
- If additional pages are needed, they are inserted between the two pages and given a letter designation.

Note: Drainage books may not be required for projects with All Inclusive Drainage items. Contact the OOC Quality Assurance Section for guidance.

1-305B Structures, Mainline Roadway, Ramps, Etc.

In addition to the Contents and General Organization requirements earlier in this section the Inspector should use the following guidelines for setting up Volume III books for structures, mainline roadway, ramps, etc. The Inspector should consider separate books for each structure, ramp, etc. if there are considerable calculations for each. If the Inspector utilizes separate books for different structures, and does not utilize SiteManager for the Master summary, a separate Master Summary book is required. This book should list the structures as designated on the plans.

1-306 Volume IV - Miscellaneous Contract Data

This volume has been designated to organize miscellaneous contract data pertaining to the project. The Volume IV shall contain an index. Templates for the sheets listed in the sample index may be obtained from the Approved Forms Folder (Vol. 4) in ProjectWise.

(Documents - 04.1 - Construction Libraries - 04.200 - Approved Forms and Inspection Checklists)

- **Record of State/Consultant Personnel.** A record of the PE and all personnel assigned to the project from the ordered-to-start date until the contractor relief of responsibility (CON 500). Include the start and completion dates for each employee and the assigned operation. A copy of this log must be maintained throughout the life of the project and retained with the project records.
- **Record of Labor Wage Checks.** This log is used to record the Labor Wage Checks performed, for each contractor and subcontractor. The record of Labor Wage Checks is not required to be maintained in the Volume 4 (on paper) if the labor wage check information is entered into SiteManager as the labor wage checks are completed. The CON 131 - Labor Wage Check, forms must be retained in the project records. These forms may be retained electronically or on paper. *Refer to Volume 1 Chapter 12 Civil Rights, Labor and Contract Compliance for additional information on labor wage requirements.*
- **Record of Certified Payrolls.** This log is not required to be maintained in the Volume 4 (on paper) if the information is entered in SiteManager. A copy of a certified payroll covering each required period for the Contractor and subcontractors must be kept at one designated location hard copy or electronic. *Refer to Volume 1 Chapter 12 Civil Rights, Labor and Contract Compliance for additional information on payroll requirements.*
- **Material Stored Inventory Log.** The material must be inspected and inventoried as specified in the Section 1-909 "Payment for Stored Materials." On large projects or projects with large amounts of materials stored, a separate Volume IV book should be created to centralize the location of all documentation for materials stored on site. This log is not required to be maintained on paper. A copy must be maintained throughout the life of the project and retained with the project records.
- **Record of Shop Drawings and Working Drawings.** All shop and working drawings pertinent to the project should be documented here. The Inspector should use this log to track and check on the progress of the submissions and review/approvals. This log is not required to be maintained on paper. A copy of this log must be maintained throughout the life of the project (if applicable) and retained with the project records. This record is not required if a document management system is employed that serves the same purpose.
- **Lighting Repair Log -** A log to maintain any lighting repair work performed, which will include a description of the repairs, and the date the work was performed. This log is not required to be maintained on paper. A copy of this log must be retained with the project records. The log must be transmitted after the Contractor Relief of Responsibility to CONNDOT Electrical Maintenance personnel.
- **Non-Compliance/Compliance Notices -** A log of Non-Compliance/Compliance Notices sent to the Contractor.

1-307 Volume V - Field Notes and Reporting Forms:

The Volume V includes Bound Field Books and Unbound Field Notes and Forms. This volume will be organized by date and subject. The outline provided below contains the minimum requirements for the organization of this volume series:

- Volume V, Book 1 series - Bound Field Books (or otherwise referred to as bound field notebooks).
 - The Inspector creates and maintains an index of field books. The index should be contained in a binder to avoid loss. The binder will be labeled Volume V Summary.

- The first Bound Field Book completed by the project staff shall be logged into the summary as Volume V, Book 1; the next completed Bound Field Book will be Volume V, Book 1A, and so on.
- Bound Field Books are labeled as follows:
 - The front cover or inside of the front cover of the Bound Field Book shall contain the dates covered, the project number, and the inspectors printed name, signature and contact phone number. Each page of the notebook shall contain the date(s).
 - If information is supplied by someone other than the inspector completing the page note the person's name supplying the information.
- The Inspector should limit the bound field book to notes, sketches, field measurements and other information recorded when a mobile device is not available or efficient, with the exception of Computations. Computations are not allowed in the Volume V Book 1 series (bound field books).
- The Inspector should limit the information in each bound field book to one construction contract.
- Volume V, Book 2 Series - Unbound Field Notes and Forms (Field Reporting Forms, Unbound Field Notes, Non-complex computations and Miscellaneous Sketches).
 - If there is more than one Volume V Book 2, the Inspector shall create and maintain an index of Unbound Filed Notes and Forms books. The index should be contained in a binder to avoid loss. The binder should be labeled:
Project #####-#####
Volume V Book 2 Summary.
 - The books shall be numbered as:
Project #####-#####
Volume V Book 2, 2A, 2B...- Field Reporting Forms, Unbound Field Notes, Miscellaneous Sketches, and Non-Complex Computations
From: (Date) XX/XX/XX To: (Date) XX/XX/XX
 - The Book 2 series may be utilized for unbound field notes, field reporting forms that are not associated with items that require delivery (weight) tickets, non-complex computations and miscellaneous sketches. *(If an item requires delivery tickets (originals) such as bituminous concrete pavement or Class "F" concrete, the field reporting forms shall be kept in the ticket folder with the tickets for the given day).*
 - New pages will be added as the work necessitates. A page is not required for each day.
 - Each page shall contain the person's signature, SiteManager user ID., project number, and the date of the corresponding DWR (i.e. the date on the page must correspond to the DWR date. If a subset of the page is related to a previous event then a note should be added on the page to identify when the event happened).
 - The Volume V page number that will be referenced from the SiteManager DWR is a combination of the date and the SiteManager user ID. If multiple pages are necessary for one date, number the second page for that date with the Inspector's SiteManager user ID -1 and so on. (Example references: Volume V Book 2 Page 030513 Angeloc, Volume 5 Book 2 Page 030513 Angeloc-1, Volume 5 Book 2 Page 030513 Angeloc-3....).
 - The measurements and computations on a page are assumed to be that of the person signing the page. Therefore a separate "Computed by" or "Field measured by" is not needed for each individual computation. Like-wise, the person checking the computations on the page may indicate "this page checked by:"
 - If information is supplied by someone other than the Inspector completing the page, the Inspector shall note the person's name supplying the information.

1-308 Project Correspondence

General: The official copy of project correspondence is to be kept in the District Office. The TSE is responsible to establish and maintain a complete chronological file of all project-related correspondence for each project assigned to them. When necessary, copies of correspondence are to be forwarded to the project field office for their records. All correspondence received in the field is to be forwarded to the District.

Unless specified to the contrary in the construction contract, project correspondence regarding compensation, disputes, Request for Change (RFC), and other contractual issues, must be sent to the PE through the District office to be reviewed and forwarded to the Contractor. Similarly, all Contractor correspondence of this nature must be sent to the District Office and then forwarded to the field office. Advance or preliminary copies of such correspondence may be exchanged at the project level, however all official copies must be sent to/from the District Office.

To properly identify project related correspondence the project number(s) should appear on the correspondence.

Routine correspondence regarding topics such as, meeting minutes, material test reports, and Requests for Information (RFIs), may be issued with the approval of the PE, at the field level. A copy of any such correspondence shall be forwarded to the District office. If field memoranda, field directives, or Non-Compliance/Compliance reports are issued by the Inspector to the Contractor relative to contract performance, the District Office must be copied.

A “List of Standard Correspondence” is located in Appendix C, Table C-1, of this manual. This table outlines responsibility for preparation of project correspondence, and also identifies the person authorized to sign the documents. This chart outlines the approval levels. Depending on the amount or seriousness of an issue a higher level of authority may be required.

Templates of the standard correspondence and many project records may be obtained from the Approved Forms located in ProjectWise.
(Documents - 04.1 - Construction Libraries - 04.200 - Approved Forms and Inspection Checklists).

Suggestions to add additional forms or revise the standard correspondence chart are encouraged and should follow the instruction in Appendix B of this manual “Update Procedures.”

Emails:

Project related emails are project documents, therefore, email prepared by District and project staff should only contain statements of fact or professional opinions. It is the goal of the Department to communicate in a way that is professional and to the point. At a minimum the PE should be copied on all emails having a possible effect on the work, schedule of the project, or staffing. (The Districts may determine a hierarchy in addition to this requirement.)

Project related email, sent and received, should be retained. It does not have to be printed if the following procedure is adhered to:

- There are 2 options for creation of subfolders.
 - Option 1 - All project and District staff may create a subfolder to their Department-supplied Outlook email inbox for each project they are assigned to.
 - Option 2 - The District may create and maintain an email central inbox on the Department Outlook system, with a subfolder for each project.
- All emails related to that project must be stored in the subfolder for that project;

- The subfolder must be backed up to the appropriate ProjectWise project Construction Documents subfolder (if this is determined by the District to not be possible contact the OOC technology section for guidance);
- At the conclusion of the project or as personnel leave the project, the District should require that all project related emails be backed up in the same manner as noted above.

1-309 Progress Meetings

Progress meetings are required to be held at least monthly on active projects. During the winter shutdown period or at other times when work activity is suspended the meetings may be held less frequently at the discretion of the TSE. The purpose of these meetings is to discuss the progression of the work and issues which may impact the ongoing work. The meeting should be conducted by the Inspector or PE. When appropriate, action items should be defined and parties assigned specific tasks with due dates. The Inspector is responsible for preparing a report of the meeting. The report should be ordered with a numerical designation for each issue and the issue should be maintained in the meeting minutes for each meeting until resolved. The report of meeting should be reviewed by the PE and be ready for distribution within 5 working days of the date of the meeting.

On Federal Projects of Division Interest (PODI) projects, the FHWA Area Engineer should be invited to each Progress Meeting and copied on the meeting minutes.

The following topics should be discussed at each meeting and included in the meeting minutes:

- Contractor's progress and review of project's schedule,
- Utilities,
- Quality and workmanship,
- Environmental concerns,
- Maintenance and Protection of Traffic/Work Zone Safety,
- Submittals,
- Testing,
- Civil Rights (DBE/SBE, Payrolls, Labor Wage),
- And General Concerns.

1-310 Other Project Records

When applicable, the following additional information should be maintained as part of the project records:

- Computer disks,
- Construction Orders (with backup),
- Contract,
- Contractor payrolls,
- Correspondence,
- Delivery tickets (originals) (separate book that is clearly labeled should be used for each type of material, including material item quantity adjustments),
- Environmental (correspondence/logs, etc.)
- EEO/Affirmative Action reports,
- Hazardous waste manifests,
- Labor Wage Checks, Form CON 131,
- Materials Certificates and all laboratory reports,

- Nuclear Density Tests and Data Sheets, such as DOT Forms CON 125 and MAT-438,
- Pile Driving Logs, Form CON 87,
- Purchase orders and requisitions,
- Semimonthly and monthly estimates,
- Schedules,
- Shop drawings,
- Working drawings,
- Request for Information (RFI),
- Request for Change (RFC),
- Engineering Clarification Memo (ECM),
- Utility forms, Forms CON 40 and CON 41,
- Trafficperson Sign in/out Log,
- Non-Compliance/Compliance Notices,
- Lighting Repair Log (related to Temporary Lighting Item),
- And Other materials, if required or requested (i.e. work performed by others, records of state furnished material.

1-311 Non-Compliance/Compliance Notices

Defective work is defined in the *Standard Specifications* Article 1.05.11. Defective materials are defined in the *Standard Specifications* Article 1.06.04. Comments related to Non-Compliance issues are required on all SiteManager DWR's. (See the procedure below for documentation.)

[Non-Compliance/Compliance Notices](#) can now be processed using one form instead of two. A dropdown arrow was added to select which Notice type is applicable.

The Non-Compliance section of the Notices is intended to document instances when the Contractor's workmanship or materials do not meet the requirements of the plans and/or specifications and which cannot be resolved quickly in the field. The process of recognizing and resolving non-compliance issues consists of the following major steps:

1. recognizing the problem,
2. proposing a corrective procedure,
3. gaining approval for the corrective procedure, and
4. completing the corrective work.

Whenever unacceptable work is encountered steps 1 and 4 above are always necessary. Depending upon the scope and/or severity of the non-compliance issue, corrective procedures may be required (steps 2 and 3). When approval is required for corrective procedures, separate correspondence is generated addressing the issue in question.

The Non-Compliance section should be filled in and the Notice issued to the contractor if any of the following conditions exist:

- Unacceptable materials are being incorporated into the work.
- The construction methods or workmanship do not meet the contract requirements or approved plans.
- Rework is required to correct a deficiency discovered on the project.
- The survey lay-out is incorrect or there is inadequate survey to verify the accuracy of the work.
- The contractor intends to place new work upon previous work that has not been accepted.

- The contractor has left the work in an incomplete state and it is possible the remaining work could be overlooked. If the project staff has adequately documented the incomplete nature of the work in the project records some other way (such as DWR, Volume 3, As-Built, White Paper Tracings, etc.), then a Non-Compliance/Compliance Notice may not need to be issued.
- The Contractor fails to meet a contract requirement other than the ones noted above within a reasonable time after being notified of the deficiency verbally or repeatedly fails to meet a contract requirement.

The following procedure is to be used for the resolution of non-compliance issues:

- If one of the instances referenced in the previous bullet list is encountered, a Non-Compliance/Compliance Notice should be issued to the Contractor that clearly identifies the problem and requests a proposed corrective measure if one is required.
- Non-Compliance/Compliance Notices are to be numbered as follows: project number_Date_0001NCN. For example, 00150025_20161016_0001NCN and 00150025_20161022_0002NCN and so on.
- For each Non-Compliance/Compliance Notice issued that requires a corrective procedure and to ensure there is agreement as to the scope of the repair work required, the final/approved corrective procedure should be issued by the District. In some instances, the correction is obvious and may be determined by project personnel. Other times approval by the District, DMT, Design or other unit(s) is required. Project personnel are to obtain such approval, when required.
- When the corrective work or deficiency of compliance with the contract requirements is resolved to the satisfaction of the District, the Compliance section is to be filled out and the Notice is to be issued to clear the Non-Compliance Notice.
- The inspector must keep a [Non-Compliance/Compliance Notice Log](#) in the project records. This log should be reviewed from time to time to ensure that all Non-Compliance notices have been resolved by a corresponding Compliance notice.
- All Non-Compliance/Compliance notices must be retained in the project records whether they are issued in paper or electronic form. Paper copies of Non-Compliance/Compliance notices should be retained in a binder and referenced from the log of Non-Compliance/Compliance Notices.
- Information regarding the notices should be entered into the appropriate field of SiteManager. *Refer to the SiteManager User Guide for direction regarding entering Non-Compliance/Compliance Notices in SiteManager.*
- If the Non Compliance/Compliance Notices are entered into SiteManager with the proper numbering, the SiteManager report for Non-Compliance/Compliance Notices may be substituted for the Excel log and run from time to time to ensure that Non-Compliances have a corresponding Compliance or resolution.

Discussion of “open” Non-Compliance issues should be included as a standing item at Progress Meetings. Specific questions pertaining to Non-Compliance/Compliance Notices should be directed to the PE. The inspection staff may not deviate from the above guidance unless approved by the PE or TSE for the project.

1-312 Working Drawings

This section describes the procedures related to Working Drawings for temporary and permanent work. The Inspector must become familiar with the requirements for each. In addition to this section there is information related to Volume 4 requirements in Section 1-306.

The current state of practice is that the Contractor must submit Working Drawings electronically. The District should review the project specifications to determine the appropriate requirements.

1-312A Working Drawings for Permanent Construction

When working drawings for permanent construction are required, the Contractor shall submit a certain number of copies of the working drawings directly to the appropriate Principal Engineer in the Office of Engineering for review (State Design or Consultant Design as the case may be). The Office of Engineering is responsible for transmitting the submission to other reviewing units as required for comments. Examples of working drawings for permanent construction are: Proprietary Retaining Walls, Precast Concrete Box culverts, Pot Bearings, Modular Joints, Permanent Soil Nail Wall, Tie-Backs, Micro-Piles, etc. In most cases the item specifications will include language that working drawings are required and may contain detailed information as to what needs to be submitted.

The working drawings are reviewed and stamped in accordance with the requirements of the specifications. After review, the reviewed working drawings should be sent to the District administering the project with a recommendation regarding acceptance.

The District is to forward the reviewed working drawings along with the review comments/exceptions to the Contractor. The District is responsible to ensure that all review comments/exceptions are appropriately addressed prior to the Contractor starting work.

The District is to retain the copy of the reviewed working drawings in the District files, and a copy in the field office files. After all comments/exceptions have been resolved, the District should forward a copy to the Materials Testing Division.

The District is to direct the Contractor to submit final pdf files (or the form required by the specifications) of the reviewed working drawings after the Contractor has addressed the review comments and made necessary changes. The District is responsible for including these files (or the form required by the specifications) as part of the “As-Built” Drawings. This should be coordinated with the District Survey Office and Engineering Applications for inclusion into ProjectWise.

1-312B Working Drawings for Temporary Construction

When working drawings for temporary construction are required, the Contractor shall submit a certain number of copies of the working drawings to the District. The District should review the working drawings relative to staging and other Contract requirements. If there are structural or safety concerns the District should forward the submittal to the appropriate Principal Engineer in the Office of Engineering for review (State Design or Consultant Design as the case may be) when necessary.

The District should forward the working drawing submittal with the review comments to the Contractor along with a statement of whether there are comments that must be addressed prior to proceeding. The specifications require that the Contractor address the comments to the satisfaction of the District prior to proceeding.

The District should retain a copy of the submittal in the District files, and one (1) copy should be retained in the field office files.

1-312C Examples of Working Drawings That Require a Review by the Office of Engineering

Permanent Construction: Proprietary Retaining Walls, Precast Concrete Box culverts, Pot Bearings, Modular Joints, Permanent Soil Nail Wall, Tie-Backs, Micro-Piles, etc.,

Temporary Construction: Temporary Sheet Piling, temporary Soil Nail Walls, Cofferdams, temporary Superstructure Supports, Falsework, Jacking, Structural Steel Erection Plans, Post-Tensioning Procedures, Containment and Collection Systems for painting, etc.

In general, the working drawings that can be reviewed by the District are minor traffic control plans, submissions related to the implementation of construction staging plans, minor steel erection schemes, bearing replacement or repair schemes, barrier relocation plans, etc.

1-313 Shop Drawings

Department designed elements require the Contractor to submit shop drawings for review. The contract should also specify the appropriate personnel in the Office of Engineering that the Shop Drawings should be submitted to for review. If the contract does not specify the Project Staff or PE should contact the lead designer and obtain the information.

The current state of practice is that the Contractor must submit Shop Drawings electronically. The District should review the project specifications to determine the appropriate requirements.

The drawings must include material lists and material designated for project use, such as:

- Reinforcing steel,
- Anchorage details for rail attachments at the ends of bridge parapets,
- Structural steel,
- Pre-tensioned concrete beams and deck units,
- Post-tensioned concrete superstructures,
- Post-tensioned pier caps,
- Concrete for structures (remain-in-place forms),
- Modular expansion joints,
- Mechanical/electrical components of movable bridges,
- Elastomeric compression seals,
- Bearings,
- Bridge scuppers,
- Pipe for bridge drainage,
- Stain protection,
- Metal bridge rail,
- Open steel sidewalk grating,
- Granite facing, and
- Illumination.

In addition to bridges, shop drawings are required for side-mounted sign supports, bridge-mounted sign supports, and tubular and truss sign supports. These sign support drawings are submitted to the Office of Traffic Engineering.

The Contractor should provide the District with a copy of the letter of transmittal for all shop and working drawings that are not sent directly to the District. If there are issues with timely review or submission of shop drawings the Inspector should notify the PE immediately.

The Inspector must maintain a log whether on paper or electronically in the Volume IV to track the shop drawings.

1-314 As-Built Drawings and Final Revisions of Plans (As-Builts)

The District Management shall develop procedures to address the following: (1) if the working as-built plan sets will be maintained on paper or electronically; and (2) if a paper working as-built set is used which of the District personnel (or consultants) will be responsible to complete the As-Built of the Digital Plans in ProjectWise at the completion of the project.

If the digital file is to be utilized for the working copy of the as-built the District must follow the guide produced by the Office of Architectural, Engineering and Construction Applications (AEC) relative to how to update the digital file. The as-built information to be documented is outlined later in this section.

The following rule has been put in place to ensure consistency related to digital as-built plans. Field personnel shall not attempt to maintain or complete digital as-built plans until they are properly trained by The AEC and a notice of successful completion of this training is sent from The AEC to the District. In addition the Office of Engineering Applications will be responsible to monitor the adequacy of the electronic as-built to make sure the inspectors are performing the task properly. If there is an issue they will contact the District Supervisory Staff of the situation. If the issue continues it will be the responsibility of AEC to administer further training for the subject personnel.

The Inspector is required to ensure that the working as-built drawings are kept up to date on the digital file (ProjectWise PDF plans) or on “paper” plans (as determined by the District Management). At a minimum the working plans should be updated once per month.

Periodically, as part of the review of project records, the PE should verify that as-built plans are being updated to reflect the work completed. They should document this review by either entering a Site Manager DWR (for PDF as-built) or initialing and dating the front sheet of the paper as-built.

When the Contractor is required to produce as-built drawings (i.e. electrical or facilities construction projects), the Inspector should periodically remind the Contractor of the requirement to submit as-built drawings and ask for an update on the status. Project staff will be responsible for notifying the AEC to add the Contractor’s as-built drawings to the Digital Project Plans on ProjectWise.

Once the As-Builts are complete the persons listed in Section 8.4 (Notifications) of AEC Digital Project Development Manual should be notified.

[Digital Project Development Manual](#)

The following is the content to be updated by OOC representatives maintaining “paper” and/or “electronic” as-built drawings:

Responsibility of Contracting Engineers: A contracting engineer must indicate the as-built features of a project in either ink on the original tracings or the digital design file, if required. The work must be accomplished in accordance with the terms of the agreement with the State. If a contracting engineer must indicate the as-built features on the tracings, it is not necessary to revise a set of prints of the plans for the use of the Highway Design Section.

Responsibility of Department Forces: Designated District staff is to revise the original tracings or digital design files on State or federal-aid projects to show the project as-built.

Methods of Showing Revisions: If revisions resulting from Construction Orders occur, the revisions are to be included in the as-built set of plans. The following notations are to be included in a conspicuous place on the original tracings:

Revisions of _____ shown on Sheet No. _____
 _____ Date of Plan Sheet
 _____ incorporated on this sheet _____
 _____ of Plan Sheet Date

Title Sheet: Use the following guidelines for the title sheet:

- *Title.* Show the corrected beginning and ending stations, and the horizontal length of the project in the title. Cross out original figures.
- *Inscription.* Inscribe the following in a conspicuous place on the sheet:
 - Construction Started Date _____
 - Construction Completed Date _____

If quantities are on the title sheet, inscribe this note: “THESE QUANTITIES NOT CORRECTED.”

Index Plan and Index Profile Sheet: Do not correct the plan and profile sheets. In a conspicuous place, inscribe this note: “THIS SHEET NOT CORRECTED.”

Detailed Estimate Sheet: Inscribe this note somewhere on the detailed estimate sheet: “THIS SHEET NOT CORRECTED.” If quantities are on the title sheet, inscribe this note: “THESE QUANTITIES NOT CORRECTED.”

Typical Section Sheets: Show any changes in the typical sections and add the note, “TYPICAL SECTION CORRECTED.”

Plan Sheets: If either the beginning or ending stations of the project have been changed, make the necessary correction and label: “BEGINNING OF CONSTRUCTION” or “END OF CONSTRUCTION.”

District personnel will utilize the procedures developed by the Office of Engineering Applications when completing as-built drawings electronically. The procedures may be obtained from the website link below:

[Digital Project Development Manual](#)

Use the following guidelines to determine the revisions that should be documented in the as-built plan-set:

- *General Construction Notes.* General construction notes are not to be corrected.
- *Culverts.* The locations, lengths, sizes and orientation of culverts must be documented in the following manner:
 - If the location of the culvert is installed within 10 feet of its original proposed location and the orientation and the size or type has not changed, label the culvert “Installed”.
 - If the location, orientation, size or type of culvert is changed in excess of the limits above, cross-off (x-out) the incorrect figures or labels, plot or insert the correct information, and label the culvert installed.
- *Catch Basins, Manholes, Underdrains, Endwalls and Ditches.* Use the procedure for culverts. For example, “INSTALLED” or “DITCH EXCAVATED.”
- *Driveways.* Plot and label as constructed and cross-off incorrect figures or labels. If not constructed, cross out.

- *Fences.* Plot as constructed. Label “WIRE FENCE ERECTED” or “CHAIN LINK FENCE ERECTED.”
- *Stone Wall Fences.* Plot in the locations constructed. Label “STONE WALL FENCE ERECTED” or “FARM WALL ERECTED.”
- *Guide Railing.* Show as constructed. Label “GUIDE RAILING ERECTED.” Cross out any not installed.
- *Single Posts.* If not proposed on the plan, plot and label “SINGLE POST ERECTED.” Single posts at each end of Guide Railing need not be shown.
- *Intersecting Roads.* Outline as constructed. Give the type of surface. Label “APPROACH CONSTRUCTED.”
- *Temporary Approaches.* Indicate by heavy broken lines and label “TEMPORARY APPROACH CONSTRUCTED.”
- *Slope Lines.* Do not revise.
- *Relocation of Buildings, Poles, Etc.* Show in the new locations.
- *Channel Relocation.* Plot in the location actually constructed. If not originally proposed, plot and label “CHANNEL EXCAVATED.”
- *Riprap.* Show the outline as constructed. Label “RIPRAP INSTALLED.”
- *Curbing.* Show the beginning and end, with the note, “(TYPE) CURBING INSTALLED.”

Profile Sheets: Use the following guidelines for the profile view:

- *Culverts, Catch Basins, Manholes and Underdrains.* For structures 15 inches or greater in diameter, plot accurately all field changes in elevation and location. Use the procedure for plan notes for these items.
- *Grade Changes.* Any field change in grade of 0.3 feet or more must be shown with a broken line. Label “GRADE AS CONSTRUCTED.”
- *Subbase.* Make all changes in subbase with correcting notes, such as “STA. _____ TO STA. _____ (DEPTH),” or if no change, put a check mark next to the original notes.

Bridge Sheet: Show all changes in the structures including super and sub structure repairs. Do not correct bar lists.

Cross-Section Tracings: Revise the final cross-section tracings only if changes in the original design were authorized or if embankment material is to be deducted from the borrow material.

1-315 Recycling of Construction Materials Reports

The Department encourages the reuse and recycling of materials on construction projects. The Department also requires documentation of the amount of material recycled. There are two periods during the year for which the amount of recycling is to be documented by the Inspector completing a [recycling report](#). A recycling report is due July 20th for the timeframe from January to June, and another is due January 20th, for the timeframe of July to December.

Enter the appropriate reporting period, year and project number. Then complete the form as follows:

- *Reuse of Material On Site.* Enter the type of material, either A or B as described below, obtained from within the limits of the project and reused on the same project.
- *Reuse of Material Off Site.* Enter the type of material, either A or B, obtained from within the limits of the project and transported off site for reuse.

- *Imported Recycled Material.* Enter the type of recycled material, either A or B, imported from beyond the limits of the project. Note: Recycled materials from beyond the limits of the project must be accompanied by a Materials Certificate and Certified Test Report, in accordance with Article 1.06.07 of the *Standard Specifications*, indicating that the material is environmentally acceptable, structurally sound and meets the contract requirements.
- *Original and Final Locations.* If possible, use station numbers and describe the application for all locations. If the material was used off site but on another CTDOT project, list the project number and application where used.
- *Percentage of Recyclable Material Used.* The percentage is derived from the amount of recyclable material utilized in an application. For example, Project XYZ has one ton of bituminous material that has been removed, the project has a requirement for 10 tons of fill. The one ton of bituminous was used as part of the fill. This yields 10 percent of recyclable material used.

All quantities must be reported in tons. Use the following factors for converting volumes to mass.

- Type A, Bituminous 1 cu. yd. = 3105 lbs. = 1.55 tons
- Type A, Concrete 1 cu. yd. = 4050 lbs. = 2.02 tons
- Type D, Glass 1 cu. yd. = 3105 lbs. = 1.55 tons

1-316 Requests for Information, Requests for Change, and Engineering Clarification Memos

Request for Information (RFI) - Is a request for clarification of the contract documents. This can include clarification of intent of information shown on the plans or in the specifications, RFI missing from contract documents and interpretation of conflicting information shown on the plans or in the specifications.

- Procedure for RFI - The Prime Contractor sends the RFI to the Project Staff/District Field Office. If the RFI cannot be resolved by the District Staff or there is any doubt in the proper response, the RFI is to be sent to the Designer for review and response. The Designer prepares a response addressed to the District and the District responds to the Contractor. A response to an RFI should be within seven (7) days of receipt. RFI's should not be sent to the Department to address payment issues, conflicts, etc. If an RFI is submitted to the Department regarding any type of claim or request for payment it should be responded to immediately requesting the Contractor submit a formal letter to the ADE.
- A sample [RFI Template](#) can be found in the Approved Forms in ProjectWise.
(Documents - 04.1 - Construction Libraries - 04.200 - Approved Forms and Inspection Checklists)

Request for Change (RFC) - This includes all requests by the Contractor to substitute materials specified in the contract documents. This also includes requests to change the methods of construction as detailed in the contract documents. Before an RFC by the Contractor will be considered, a formal written request from the Contractor must be made to the District and written approval secured before any change in the design will be sanctioned. Refer to Chapter 1-23 Value Engineering for guidance related to Contractor requests for additional changes.

- Procedure for RFCs - The Contractor may be of the opinion that the Contract documents or proposed construction materials may be modified to provide a benefit to the Contractor without diminishing the performance or durability of the finished work. The Contractor may submit an RFC to the District's ADE in writing. The District must determine the appropriate parties for review. If design review is required, the request should be sent to the appropriate Project Manager in Design. Design should forward the request, if required to the Consultant Designer for their

comment and/or recommendations. Design should forward their recommendation to the District after reviewing the request and/or the Consultant Designer recommendations. The District, in conference with the designer of record, should consider the cost, impact to the public, and service life implications when making the decision to approve or not approve the request. If the Department may be due a credit, if the District believes that the Contractor is benefiting from the change, or that the Department will not participate in increased costs, it should be addressed prior to approval and documented in correspondence. The written response should be sent to the Contractor from the ADE or TSE if no money is involved within 30 days, unless other circumstances prevent it.

- A sample [RFC Template](#) can be found in the Approved Forms in ProjectWise.
(Documents - 04.1 - Construction Libraries - 04.200 - Approved Forms and Inspection Checklists)

Engineering Clarification Memo (ECM) - Is a clarification request from the Inspector/PE to the Designer. ECMs may be utilized to request for clarification of the intent of information shown on the plans or in the specifications, request information appearing to be missing from the Contract documents, request an interpretation of what appears to be conflicting information shown on the plans or in the specifications, as well as others.

- Procedure for ECM - District Staff (Inspector/PE) prepares and forwards the ECM to the Project's Lead Designer. The Designer should prepare a response to the ECM within 7 days of receipt in their office. If deemed appropriate by the District, the project staff may forward the information to the Contractor for their use.
- A sample [ECM Template](#) and [ECM Index Spreadsheet](#) can be found in the Approved Forms in ProjectWise.
(Documents - 04.1 - Construction Libraries - 04.200 - Approved Forms and Inspection Checklists)

Chapter 4 – Materials Testing

1-401 General Responsibilities

Evaluation of the quality of materials is an important part of the Department’s Quality Assurance Program. It involves visual inspection, sampling, and testing as well as Supplier/Fabricator certifications. The Division of Materials Testing (DMT) representatives and the District Construction representatives have separate and important responsibilities for inspecting, sampling, and testing of materials. Cooperation by all is required to effectively evaluate and determine the compliance of materials to the project specifications.

In accordance with Article 1.06.01-1 of the *Standard Specifications*, within 30 days following the award of the contract, the Contractor is required to submit on Form CON-083 the anticipated sources of selected materials intended to be used on the Project. Project staff and DMT staff should locate this document in ProjectWise and review for potential issues. If the sources are revised from those initially submitted, the Contractor has 10 days to furnish a supplementary statement and any required samples of said proposed materials prior to placing an order for any such material from the list. Project staff should consult DMT staff if sources are unfamiliar or suspect.

1-401A District Construction

District Construction personnel responsibilities:

The Construction Districts must take steps to ensure that project inspection related to materials, sampling, and testing on federally funded National Highway System projects are performed by Northeast Transportation Technician Certification Program (NETTCP) certified personnel and that all other projects have qualified personnel perform visual inspections, sampling, and testing.

The primary responsibility for adequate and sufficient testing rests with the project Chief Inspector (CI). The CI must make efforts to ensure the sampling, testing, and visual inspections comply with the requirements of the Contract Special Provisions, “Minimum Schedule for Acceptance Testing,” and the “Minimum Schedule for Assurance Testing” and any other contract documents. The “Minimum Schedule for Acceptance Testing” and the “Minimum Schedule for Assurance Testing” are included in the [“Quality Assurance Program for Materials”](#) document issued by the Division of Materials Testing and available on the DOT website (Doing Business – All Resources – Publications –Materials Testing Manual).

The responsibilities of the CI include ensuring that:

- the materials submitted for testing are sampled or are observed being sampled by State forces or a designated representative;
- the inspectors under their supervision are inspecting, sampling, and documenting the project materials in accordance with the requirements;
- adequate inspections, sampling, and testing is being performed to generally support the monthly estimates that are being processed for the project;
- assurance testing is scheduled as required via e-mail notification to the DMT’s District Laboratories;
- acceptance samples are obtained and scheduled for delivery to the DMT via e-mail notification to the DMT’s District Laboratories;

- the review of original and new contract items added by Construction Order (CO) are coordinated with the Project Engineer (PE) to associate the proper material codes and remove non-applicable ones;
- the DMT is notified that coverage is required for paving operations;
- copies of field test reports (field density, concrete air content, slump, temp etc.) are furnished to the DMT if required;
- project specific concrete and bituminous mix designs are provided by the Contractor for review by the DMT;
- and, the DMT is notified of the final disposition of material recommended for rejection utilizing the MAT-103, "*Report of Rejected Material.*"

The designated project staff must review the minimum testing requirements when a contract item is added by CO to ensure that the appropriate materials are associated to the new item. Following this review, the project staff should contact the DMT to request the appropriate material codes be assigned.

A project inspector is responsible for visual inspections of the materials on the project site and taking physical samples, in accordance with the requirements noted above, using accepted sampling methods such as those prescribed by the American Concrete Institute (ACI) and the (NETTCP) to ensure that the samples of materials are representative of the material used.

It is the Contractor's responsibility to have sufficient materials at the Project for testing by the Department prior to use.

The PE should review the CI's work from time to time to ensure adherence to material testing requirements. The District should also supervise a periodic review of each project to ensure that the item quantities paid to date agrees with the quantity of the materials visually inspected by project staff and/or recommended for acceptance by the DMT.

1-401B Division of Materials Testing

Responsibilities of the DMT or its Designated Representative:

- Ascertain that materials inspection, sampling, and testing on federally funded National Highway System projects is performed by certified personnel according to Contract specifications.
- Ascertain that materials inspection, sampling, and testing on projects funded otherwise have qualified personnel performing those tasks.
- Review Bituminous and non-standard Portland Cement concrete mix designs.
- Respond to Requests for Tests in a timely fashion and post recommendations for material acceptance or rejection within SiteManager. See Section 1-402G.
- Post detailed results of testing within SiteManager where possible.
- Support the Office of Construction (OOC) on all matters pertaining to the sampling, testing, fabrication, inspection and production of materials.
- Directly notify Project Staff by phone or email when a material is recommended for rejection. Test results may be provided to the Project Staff if requested. Test results are not provided to the Contractor/subcontractor/vendor by DMT staff. See Section 1-402H.
- Issue Final Material Certification (FMC) to FHWA for Projects of Division Interest (PODI) projects and for other roadway construction projects to the Contract Administrator. Contract Administrators of facilities (vertical/non-roadway) projects construction projects are provided an email from DMT staff as described in Section 1-2207.

1-402 Standard Procedures***1-402A General***

All materials are subject to visual inspection, testing, and acceptance or rejection at any time during preparation, use, and following installation depending on the material and circumstance. The general rule in accordance with the *Standard Specifications* is that materials should be tested and approved prior to installation. If the materials are not sampled, tested, and approved prior to installation, the Contractor is installing them at its own risk. The project staff should be aware of this and seek guidance from the appropriate District's supervisory staff if testing results recommend rejection following installation.

When a project is activated in SiteManager, the contract items that include materials requiring acceptance or assurance testing should, by default, have material code(s) assigned to them. The Project Engineer and Chief Inspector should review the materials associated with the contract items and notify the DMT if additional material codes are necessary or if certain material codes are not necessary. This review should be performed periodically throughout the project lifecycle so the Final Material Certification (FMC) process is streamlined.

The "Minimum Schedule for Acceptance Testing" and the "Minimum Schedule for Assurance Testing" detail the information necessary for the inspector and other staff to determine the proper material inspection and sampling needs for most materials. The following list contains the major categories of information detailed in the schedules:

- the staff responsible for sampling,
- Request for Test (MAT-100) requirement,
- sample type,
- the sample size,
- the location for sampling,
- the frequency for acceptance sampling,
- the frequency for assurance sampling, and
- any special instructions.

Specifications should indicate the acceptance criteria for the material(s). These criteria could include sampling and testing not included in the "Minimum Schedule for Acceptance Testing." In the absence of direction, Project Staff can request physical testing or certification to ensure acceptability of materials.

The inspection staff must review the *Standard Specifications* and the Contract Special Provision(s) to ensure adequate inspections, samples, and tests are performed for each item.

The inspection staff should keep in mind that Federal and State regulations require that at least the minimum number of inspections or tests be conducted, as determined in the "Minimum Schedule for Acceptance Testing," the "Minimum Schedule for Assurance Testing," and the Contract Special Provisions.

Project sampling and testing falls into the following general classifications:

- Quality Control (QC) inspection, samples and tests are those performed by the Contractor to provide quality control of their process/material.
- Acceptance inspections, samples, and tests are those performed, by DOT personnel or a designated representative to determine material compliance with the Contract specifications.

- Assurance samples and tests are those performed by or under the supervision of DMT personnel, field personnel, or representatives of other federal agencies to provide an independent check on the sampling and testing equipment and the personnel performing these tasks. Assurance testing is important in that it validates the results and recommendations of the acceptance (and if applicable QC sampling and testing done on the project).
- Verification samples are used to validate the Contractor’s QC test data used in process control for the product. DMT personnel are responsible for these samples.

1-402B Bituminous Concrete Production Notification

The CI is responsible for documenting scheduled paving and verifying the specific mix design from a source is acceptable through the “PaveTrack” application. (Refer to Section 2-506A).

1-402C Project Staff Inspections

The “Minimum Schedule for Acceptance Testing” (Chapter 8 in the [Materials Testing Manual](#)) was updated in 2015 and 2017 to reduce the number of MAT-100’s required to document visual inspections performed by the inspector during the normal course of inspection. These changes have resulted in the following procedure:

There are four “Test Types” associated with “Tests” designated “Project Staff” in the “Minimum Schedule for Acceptance Testing.” These materials do not require a MAT-100 or formal tracking of quantities sampled and tested. These test types are Visual, Qualified Products List (QPL), Materials Certificate (MC) and FLDT and are outlined in detail below. The SiteManager’s Daily Work Report (DWR) will be utilized to document the project staff’s comparison of the materials installed or to be installed to the item’s material specification.

There are two “Sample Types” – ‘No Req for Test’ and ‘Accept (Field)’ – within the four “Test Types” as indicated below that need to be documented by Project Staff. The documentation procedures for each scenario are described below:

Scenario 1 will cover the majority of the project staff’s tests in which the test type is visual.

Scenario 1			
MAT-100	Sample Type	Test Type	Test
NO	Accept (Prod), Accept (Field)	Visual	Project Staff

By virtue of making full payment for the number of units installed, the inspector is acknowledging and documenting that the material is in general conformance with the specification to the best of his/her knowledge. No further documentation is necessary.

Scenario 2 will cover tests in which the Qualified Products List (QPL) is the test type.

Scenario 2			
MAT-100	Sample Type	Test Type	Test
NO	Accept (Prod), Accept (Field)	QPL	Project Staff

The Inspector will document the material being in general conformance with the specification by entering full payment for the number of units installed and noting the Manufacturer, model number, etc. complies with the QPL, in one of the first three lines of the SiteManager DWR item remarks field. If there are

multiple materials to address for one item, enter, “see later item remarks for material inspection” in one of the first three lines of the SiteManager DWR item remarks field and add a note for each material later in the item remarks field. This review of the material to the (QPL) must be performed and documented at least once during initial installation of the material. All other payments made for full units of the material indicate general conformance with the requirements of the specifications to the best knowledge of the Inspector. No further documentation is necessary, unless the Contractor supplies different materials. If the Contractor switches material, perform the steps above for the new material(s).

Scenario 3 will cover tests in which the (MC) is the test type.

Scenario 3			
MAT-100	Sample Type	Test Type	Test
NO	Accept (Prod), Accept (Field)	MC	Project Staff

The Inspector will document that the Material Certificate (MC) complies with the requirements of Section 1.06 of the *Standard Specifications* and that the material appears to be in general conformance with the applicable item specification by: (1) Entering full payment for the number of units installed; (2) Noting, based on the material certification for the material name, manufacturer, model number, and etc., that it “appears to comply with the specification requirements,” in one of the first three lines of the SiteManager DWR item remarks field. If there are multiple materials to address for one item, enter, “see later item remarks for material inspection,” in one of the first three lines of the SiteManager DWR item remarks field and add a note for each material later in the item remarks field; and (3) Placing the MC in the appropriate project binder or folder and adding a reference to the location of the MC in the item remarks field. This review of the material and Material Certification must be performed and documented at least once during initial installation of the material. All other payments made for full units of the material indicate general conformance with the requirements of the specifications to the best knowledge of the Inspector. No further documentation is necessary, unless the Contractor supplies different materials. If the Contractor switches material, perform the steps above for the new material.

Scenario 4 will cover tests in which a Field Test (FLDT) is the test type.

Scenario 4			
MAT-100	Sample Type	Test Type	Test
NO	Accept (Prod), Accept (Field)	FLDT	Project Staff

The Inspector will document that the material in-place density complies with the requirements of the specification by: (1) Entering full payment for the number of units installed; (2) Noting, “Compaction appears to comply with requirements,” referencing the location of the Compaction Report, in one of the first three lines of the SiteManager DWR item remarks field. If there are multiple materials to address for one item enter, “see later item remarks for material inspection” in one of the first three lines of the SiteManager DWR item remarks field and add a note for each material later in the item remarks field; and (3) Placing the Compaction Report in the Volume 5 or other project folder. The project staff shall ensure an adequate number of compaction tests are performed in accordance with the [Minimum Schedule for Acceptance Testing](#) (Chapter 8) Summaries of field density testing for (FMC) purposes at the conclusion of the project are no longer required.

All materials inspected by Project Staff that do not appear to meet specifications should be documented using a Non-Compliance Notice.

1-402D MAT-100, Request for Test

A MAT-100, Request for Test, form must accompany an acceptance sample (as noted in the “Minimum Schedule for Acceptance Testing”) and an assurance sample (as noted in the “Minimum Schedule for

Assurance Testing”) and must be submitted to the DMT. Certifications (certified test reports and materials certificates) kept in project files do not initiate the creation of a MAT-100.

The CI must ensure that they or their project staff arrange (through coordination with the DMT) for the delivery of samples to the DMT, except those to be tested at the source of supply.

1-402E SiteManager

The Inspector should consult the SiteManager User Guide for guidance related to processing a MAT-100 utilizing SiteManager. A sample MAT-100 is shown in Figure 1-4.1. A major difference between the SiteManager MAT-100 and the hardcopy version MAT-100 are the fields labeled “Smpl Type” and “Acpt Meth.”

The “Smpl Type” is the type of sample being submitted. A list of the choices available in the “Smpl Type” pull-down menu in SiteManager and the appropriate usages of each option is provided below:

- *Acceptance (Production)* – To be used for all samples submitted where the project is looking for a recommendation for acceptance or rejection.
- *Assurance* – To be used for all samples/testing used to validate equipment or personnel performing the acceptance testing.
- *Bid Sample* – This designation is not for project staff use.
- *Information Only* – Use when results are not used to determine acceptance or rejection. Example: Concrete cylinders were broken prior to bridge deck opening or form removal.
- *Maintenance Sample* – This designation is not for project staff use. This option is for use by maintenance personnel.
- *Source Sample* – This option is for source samples of earth materials (such as gravel, sand, etc.) and also for use by lab personnel.
- *Spaces* – To be utilized as directed.
- *Stores Sample* – Not for project staff use. For use by lab personnel.

It is important that project personnel select “Acceptance (Production)” when submitting a sample for material and quantity that is being permanently incorporated into the project. This is the only type of sample that will provide material test coverage for the project.

It is equally important that “Assurance” be selected for those materials that need assurance testing coverage. A project must perform assurance testing in accordance with the “Minimum Schedule for Assurance Testing,” or that testing will be listed as a deficiency on the Final Materials Certificate.

“Acpt Meth” is the method used to determine if the material will be recommended for acceptance or rejection. The following are available from the pull-down menu. Examples of what materials apply to these methods are shown in parentheses.

- *Field Test* - (Ex. HMA and Soil Density)
- *Lab Test, Mat Cert & Certified Test Report* - (Ex. Epoxy Pavement Markings)
- *Laboratory Test* - (Ex. Aggregates)
- *Mat Cert & Certified Test Report* - (Ex. Anchor Bolts)
- *Material Certification* - (Ex. Construction Barricades, Impact Attenuators)
- *PC-1* - (Ex. Catch Basin Components)
- *Past Performance* - (Lab use only)
- *Qualified Products List* - (Ex. Erosion Control Matting, Geotextiles)
- *Spaces* - To be utilized as directed.

- *Visual Inspection* - (Ex. Riprap, Stone Walls)

Project personnel are responsible for selecting the appropriate sample type and acceptance method. For example, a MAT-100 for gravel that is an “Acceptance (production)” sample indicates that the “Laboratory Test” acceptance method requires a sample and a physical test at the DMT. A MAT-100 for gravel that is the same sample type but indicates the “Field Test” acceptance method requires testing at the project site on an in-place material and no physical sample or lab test.

SiteManager material code requirements for construction order items should be brought to the attention of the DMT via email as soon as possible.

At project start up, periodically throughout the course of the project, and again prior to requesting the FMC, the CI or resident engineer will review the Item Material Assignment by Item Code report in SiteManager and request the addition or removal of any material codes in SiteManager, as necessary, to comply with the minimum testing requirements and the Contract Special Provisions. For activities related to materials testing at project start up, refer to Section 1-201.

In order to promote consistency, the ability to modify the association of materials to contract items resides with DMT personnel. Project personnel must contact DMT personnel via email to modify these associations.

Figure 1-4.1 Sample MAT-100, Request for Test, on SiteManager

State of Connecticut
Department of Transportation
Material Test Report (MAT-100)

SAMPLE ID	C0063-0703B0008	REMARKS
Material Code	04057	
Material Description	HMA, Level 2	
Sample Date	20190711	
Inspector Name	Nguyen, Tai B.	
Source of Supply	Galasso Materials (Batch), East Granby	
Producer/Supplier Code	0646	
Material Rep Qty	15.94	
Sample Unit	ton	
Sample Acceptance Type	ACP	
Acceptance Method Type	FLDT	
Purpose/Intended Use	Catch Basin Reset Patch	
Location of Sample		
Town	Hartford	
Contract Number	0063-0703	
District Number	1	
Federal Project Number	FHWA 90% 1063(143)	
Field Office Number	8605007769	
Sample Status	A	
Created By	nguyent	
Sample Last Modified By	garretm	

Project Number	Line Item Number	Item Code	CAT	Item Description	Rep. Qty
0159-0191	0630	0586600	0001	RESET CATCH BASIN	15.94
Total Represented Quantity:					15.94

1-402F Assurance Samples and Tests

The “Minimum Schedule for Assurance Testing” details the items and materials that require assurance samples and tests. This includes, but is not limited to, embankment, pavement, fill pavement base, and concrete. To ensure that required assurance sampling and testing is performed as required, it is necessary that the CI or other project staff notify DMT personnel of the need for these samples and tests with as much advance notice as possible. Assurance samples and tests performed by DMT personnel must be in accordance with the following:

- When assurance samples are required for materials subject to gradation analysis, DMT personnel must be contacted to witness the sampling procedure at the project site. The samples are then transported to a District Laboratory and halved in accordance with AASHTO T248. One-half of the assurance samples are tested at the District Laboratory. If desired by project personnel, this sample can additionally serve as the acceptance sample for the appropriate test coverage. The other half of the assurance sample is for DMT use and is utilized for the purpose of making independent checks on the reliability of the results obtained from various equipment, personnel, and testing facilities. If any set of results shows a variation greater than the expected deviation, it is the responsibility of the Central Laboratory to investigate the cause and, if necessary, to see that appropriate corrective action is taken.
- When assurance tests are required for Portland cement concrete testing, DMT personnel must be contacted to witness all required sampling and testing procedures at the project site. DMT personnel record on the assurance testing forms all pertinent testing data, observations of the testing procedures, and the names of all persons involved in the tests and molding of the specimens. DMT personnel additionally perform side-by-side air content testing, verify that equipment is calibrated, and confirm that the proper testing procedures are being followed and the appropriate equipment is being utilized at the field-testing sites. If there are any deficiencies, District Construction offices are notified that corrective action is required.
- Assurance tests for concrete cylinders must include air content, temperature, and slump tests on the plastic Portland cement concrete. DMT staff indicates on the assurance testing form the names of all persons involved in the tests and molding of all specimens. The cylinders molded during an assurance test can be submitted for acceptance testing provided they are submitted with a separate MAT-100. It is possible that the material could be recommended for rejection, and the assurance test could be acceptable or vice versa.
- When assurance testing is required for a project’s field density testing of unbound material (i.e., borrow, subbase, pervious, structure backfill, etc.), project staff must contact District personnel to observe the test site preparation and testing procedure. Two density gauges are typically used in the assurance testing procedure. The additional gauge will be used by District personnel (Assurance Inspector) to assure the results from the gauge being used on the project are valid. The test report (MAT-440) must be completed by District personnel and kept in the project records. District personnel may perform this task in other Districts as resources allow.

1-402G Test Results

Generally, test results will be posted to SiteManager. The CI should take steps to ensure review of test results and pending tests prior to approving payments on a payment estimate.

The DMT will attempt to notify the project staff of test results as soon as possible via email or verbal communication if a test yields a recommendation for rejection. In certain instances, the DMT will attempt to email or verbally notify the project staff for other critical materials. If a verbal or email notification is provided by the DMT either recommending acceptance or rejection of the material, a notation is generally made on the Request for Test by DMT personnel. Project personnel can access the testing status through SiteManager after it is posted.

Typically, results of testing performed by DMT personnel are not provided directly to the Contractor. Requests from a Contractor for test results must be coordinated through the District.

1-402H Samples Recommended for Rejection

If the DMT determines that a sample does not meet specification, a representative from the DMT should contact the CI or PE and provide the results of the tests. A detailed test report may also be issued. Copies of all test reports are on file at the DMT.

1-402I Buy America Requirements

As stated in Article 1.06.01-2 of the *Standard Specifications*, “All permanently incorporated steel and iron used in the construction of the Project must have been produced and fabricated in the United States.” Steel products are defined as manufactured products made of any percentage of steel or iron (by weight). Therefore, materials that are identified in the Contract or in bid options specified in the Contract and that are intended to be left in place at the end of the Project shall be subject to the Buy America requirements in accordance with Title 23 CFR 635.410. These requirements also include welding, welding rods, as well as items that would be impracticable to remove due to design, construction staging, or other functional requirements.

DMT personnel review all documentation submitted with MAT-100, Request for Test, forms for steel and materials containing steel and recommend acceptance or rejection based on this review. As part of the enforcement of contract Specifications for materials, it is important that all project personnel be aware of the Buy America requirement and notify their chain of command and the DMT if there is evidence or suspicion that this requirement is not being met. Keep in mind these requirements also apply to all Utility Agreements using FHWA Funding or any project that falls under the scope of National Environmental Policy Act (NEPA). Therefore, regardless of other contract funding sources, if one construction contract is funded with FHWA funding, the other contracts justified under the same NEPA document will be governed by these requirements.

Buy America requirements apply to products including, but not limited to, steel or iron products used in pavements and roadway structures, traffic control devices, guiderail, fence, and utility materials. Examples are as follows:

- fabricated structural steel;
- reinforcing steel;
- piling, incorporated sheet piling;
- high strength bolts & anchor bolts;
- dowel bars;
- bridge bearings;
- cable wire/strand, pre-stressing/post-tensioning wire;
- motor/machinery brakes and other equipment for movable structures;
- guiderail, guiderail posts, end sections, terminals, cable guiderail;
- steel fencing material, fence posts;

- steel or iron pipe, conduit, grates, manhole covers, risers;
- mast arms, poles;
- standards, trusses, or supporting structural members for signs, luminaires, or traffic control systems;
- and steel or iron components of precast concrete products, such as reinforcing steel, wire mesh and pre-stressing or post-tensioning strands or cables.

As further stated in Article 1.06.01-2, “The Contractor may request, in accordance with Section 635.410(b)(4) of Title 23 CFR, approval to include a minimal amount of foreign steel in the Project’s construction.” These requests must be made in writing. The District may approve these requests provided the overall value of the foreign steel, including delivery cost to the project, is less than 1/10 of 1% of the total Contract price or \$2,500.00, whichever is greater. When multiple approvals are requested, the combined total cannot exceed the minimal amount defined above.

There may be other circumstances where the Contractor cannot obtain specific steel materials from a domestic source and, therefore, will require a waiver to use foreign steel. Should this occur, the District will obtain from the Contractor details of the efforts made to secure domestic steel. The District will forward this information to the OOC’s liaison engineer for review and a determination on whether a Buy America Waiver should be requested from FHWA on federally funded projects. Processing of Buy America Waivers can require significant time and, therefore, are typically initiated during the design phase. The OOC’s liaison engineer will coordinate with the FHWA on any waivers to be requested.

Foreign steel should never be permanently incorporated into the project unless approved. Steel and iron products that are to be used on a temporary basis and removed from the project are not subject to the Buy America requirements. If there is a potential for temporary sheet piling to be left in place, then Buy America requirement will apply. Inspection personnel are required to track the value of all foreign steel delivered to the project and provide documentation to the DMT at the conclusion of the project that substantiates required waivers and/or approvals have been obtained.

Since projects with FTA or FAA funding have separate requirements under their own Buy American clauses, it is best to check the Contract documents as they would supersede the requirements of the *Standard Specifications*.

1-402J Structural Steel Fabrication Inspection Off-Site

In accordance with the requirements in Article 6.03.03-3(a), Shop Fabrication: (a) Notification, the DMT provides onsite quality assurance inspection at any facility fabricating structural steel that includes, but is not limited to, bridge girders or trusses, building trusses, sign supports, span poles, railings, or any fabricated steel item that is controlled by a shop drawing. The inspection is intended to monitor the fabricator’s adherence to the Department’s and the project’s specifications and advise project staff on the progress of the work. It is the responsibility of DMT staff to keep District project personnel informed so that any action that may be required on the part of the Contractor can be initiated as soon as possible.

While every attempt is made to assure that steel is fabricated correctly at the fabrication facility, project personnel should be aware that incorrect, incomplete, or unacceptable material may be delivered to the project site. The Department’s role is to perform acceptance testing, not quality control. The inspection staff should keep in mind that it is the Contractor’s responsibility to perform the project work in accordance with the contract, to monitor the work of its subcontractors, and to institute and maintain quality control procedures appropriate for the proper execution of the project work. A visual inspection of the materials delivered to the project site should be performed by project personnel to detect any damage during transportation. It should be made clear to the Contractor that structural steel is not accepted at any stage prior to being properly erected or installed in its final location. A MAT-100 should be submitted after delivery and onsite visual inspection. If there are any visible abnormalities in the consistency of the steel, damage to the finish or the member, or other questionable features identified during an inspection, the

District supervisory staff and DMT should be contacted immediately for guidance. The Contractor should also be notified of the questionable feature of the steel. In general, the DMT will not process the MAT-100 until all the information regarding its acceptability is known.

1-402K Non-standard Testing Procedures

The designer establishes the acceptance method of all materials for which a standard testing procedure has not been identified in the special provisions.

1-402L Specialty and Proprietary Items

Some specialty items incorporated into transportation projects through a special provision are not physically sampled and tested by the Department. Recommendations for acceptance or rejection of these materials usually are contingent on receipt of a satisfactory material certificate, certified test report, or both. In general, the following procedures pertain to the testing of specialty and proprietary items.

If a proprietary item is specified in the special provisions or the plans, it is understood that this represents the standard required. The Contractor may propose a similar product by another manufacturer; however, the change must be approved by the designer through the RFC process. Materials that require a material certificate and/or certified test report and have a test responsibility of “Project Staff” or “Central Lab” are handled as outlined in Sections 1-403 and 1-404. Generally, the Department specifies testing requirements of specialty and proprietary items in the special provisions of contracts. The inspector should review the special provisions for testing requirements.

1-403 Materials Certificate (MC)

A MC is a document that certifies that the materials, components, and equipment furnished conform to all requirements of the plans and specifications.

The MC must include the specific information listed in Article 1.06.07 of the *Standard Specifications*. Field personnel should only forward MCs to the DMT with a MAT-100, Request for Test, for those items with a test responsibility of “Central Lab.” All other MCs must be reviewed by project staff to confirm the material delivered to the project is represented by the documents. These should be kept in the project records and not submitted to the DMT.

1-404 Certified Test Report (CTR)

A CTR is a document containing a list of the dimensional, chemical, metallurgical, electrical, and physical results of actual tests of the materials involved. It must certify that the materials meet the requirements of the plans and specifications. The CTR must include the specific information listed in Article 1.06.07 of the *Standard Specifications*. If the consignee listed on the CTR is not the prime contractor, a MC is required to identify the shipment.

Field personnel should only forward CTRs to the DMT with a MAT-100, Request for Test, for those items with a test responsibility of “Central Lab.” All other CTRs must be reviewed by project staff to confirm the material delivered to the project is represented by the documents. These should be kept in the project records and not submitted to the DMT.

1-405 Final Material Certification (FMC)

Federal Regulation Title 23CFR 637 requires that the Department have in place an approved Quality Assurance (QA) Program for materials used in federal-aid highway construction projects. The final procedure in the Department's QA program is to produce a FMC for individual projects and submit them to the FHWA. The FMC documents the testing of materials permanently incorporated into the project and the results of that testing is in accordance with the "Minimum Schedule for Acceptance Testing," and the "Minimum Schedule for Assurance Testing," Chapters 8 and 9 respectively within the [Quality Assurance Program for Materials](#) (Materials Testing Manual).

During the course of a project, DMT personnel work with project personnel to meet the requirements of the schedules of acceptance testing and assurance testing.

Inspectors are urged to address all testing deficiencies and material rejections when they occur or on a regular basis. Inspectors are reminded that any Report of Rejected Material (MAT-103) submitted to the DMT must be the original with appropriate signatures.

Projects that span more than one construction season should not carry over any deficiencies or rejections into the next construction season. Processing of deficiencies or rejections older than 12 months will be significantly delayed as priority will be given by the DMT to address current issues.

When at least 95% of the construction work is complete, and before the Contractor has been relieved of its responsibility, the District should request that a FMC be issued for the construction project. The Federal Aid Project (FAP) number must be included with the request.

As part of drafting this request, project personnel should review the following SiteManager reports and appropriately document any testing deficiencies or rejected material not previously documented.

- Contract Testing Deficiency Report
- Final Material Cert. – Item Qty. Summary
- Samples Saved without Status
- Samples Pending
- Contract Sample Rejection List
- Contract Assurance Samples "AT"
- Contract Assurance Samples "CP"

The Request for FMC does not require transmittal of the following:

- Product data or other documentation of materials approved for use by the designer.
- Project inspection staff evaluated materials with a test type of FLDT, MC, QPL, or Visual.

The Assistant District Engineer or District Engineer may accept material that was tested and rejected or material that was not tested if the conditions to waive noncomplying test results, listed in Article 1.06.02, are met. The District will notify the DMT in writing upon accepting the material. If the DMT takes exception to the District's findings, the matter will be referred to the Construction Administrator.

The request for an FMC should document all testing deficiencies and rejected materials not previously documented. The request is addressed to the Division Chief of the DMT. If all deficiencies and rejections are documented adequately, the issuance of an FMC will be provided in a timely manner.

Chapter 5 - Adjustment of Contract Items & Differing Site Conditions

1-500 General

While performing construction activities, it may become apparent in certain situations that there is a need to adjust a contract item. In comparison to the original Engineer's estimated quantity, an increase or decrease by more than 25% may be cause for an item adjustment. In some cases, the contract may need to be adjusted if the Contractor can substantiate a Significant Change in the Character of Work, or that a Differing Site Condition was encountered.

This section explains the process of determining and adjusting the contract for Minor Items, Major Items, and Differing Site Conditions. Due to revisions to the Standard Specifications in the January 2017 Supplemental Specifications, the corresponding sections in this chapter have been modified. Part 1 of each section clarifies direction from Construction Manual version 3.0 and is applicable to Supplemental Specifications prior to January 2017. Part 2 of each section is applicable to all projects being administered using the Supplemented Form 817 January 2017 or a more recent edition.

1-501 Part 1 (projects pre-January 2017 Supplements) Article 1.04.02

Payment for minor items may only be adjusted under the procedures detailed in Article 1.04.02 of the Standard Specifications. Under this article, when the quantity of a minor item increases or decreases by 25% from the original estimated quantity, the Department should make an adjustment in one of following three ways.

The preferred approach is for the Department and the Contractor to agree on price. That price will have to be substantiated by the District in a method similar to substantiating a new item of work (see section 1-601 Agreed Price). If that approach is unsuccessful, the Department can direct the Contractor to perform the work in a cost-plus manner in accordance with Article 1.09.04. If neither of these approaches are used, the adjustment of the original Contract unit price shall be the difference between the Contract unit price and the actual unit price to be calculated when all work under the item has been completed. Calculations of actual costs for either increases or decreases in minor item quantity should be made by the Engineer in the same way that they would if payment were to be made on a cost-plus basis under Article 1.09.04. Increases over 125% are to exclude one-time fixed costs. Decreases under 75% are to include the one-time fixed costs. If further explanation is necessary, consult with the District ADE.

The methods of adjusting the Contract price of a minor item using cost plus calculations are not to be used when the adjustment is due to a significant change in the character of work or differing site conditions. That type of adjustment must be calculated in accordance with Article 1.04.03 or 1.04.04 of the Standard Specifications.

Adjustments to Minor Items must be approved by the Assistant District Engineer or District Engineer.

1-501 Part 2 (projects with January 2017 Supplements) Article 1.04.02

The January 2017 Supplements (Article 1.01.01) redefined Major Items and Minor Items as follows:

Major Item: An individual Contract item, whose value at the time of bidding (either lump sum price or the product of its unit price multiplied by its estimated quantity) is equal to or greater than 10% of the total original Contract bid price shall be considered a Major Item.

Minor Item: An individual Contract item that is not a Major Item.

The Standard Specifications Article 1.04.02 details the criteria that must be met in order to allow adjustment of the unit prices.

1-501A Part 1 (projects pre-January 2017 Supplements) Increases of More Than 25%

According to Article 1.04.02(a), if the minor item is being increased by more than 25%, any fixed costs which are part of the actual costs of the work, “shall be deemed to have been recovered by the Contractor as part of the payments made by the Department for the 125% of the Engineer’s estimate of that item; such fixed costs shall be excluded from any computation of the actual unit costs.” Also, the adjustment of price is only for the excess quantity over 125% of the original quantity. The quantity less than 125% of the minor item being increased should be paid at the original unit price.

Absent prior written approval by the OOC, no adjustment should be made for items increased by more than 25%, “When the total compensation payable for the excess item units would be less than \$25,000 if they were paid for at the original Contract unit price.”

1-501A Part 2 (projects with January 2017 Supplements) Quantity Increases of More Than 25%

Although the introductory paragraphs of 1.04.02 reference significant changes in the character of work and differing site conditions, Article 1.04.02(a) of the Standard Specifications applies only to minor items. This article outlines the criteria and methods for the adjustment of Minor Item unit prices.

Article 1.04.02(a) clarifies that one time fixed costs, which are part of the actual costs of the work, are to be deemed to have been recovered by the Contractor as part of the payments made by the Department for the 125% of the Engineer’s estimate of that item. Because of this, these fixed costs are to be excluded from the computation of the actual unit costs for the units in excess of 125%. An example of a one-time fixed cost could be mobilization of equipment.

1-501B Part 1 (projects pre-January 2017 Supplements) Decreases of More Than 25%

Price adjustments for minor items decreased more than 25% must be requested in writing by the Contractor before any adjustment is made. According to Article 1.04.02(b), if the minor item is being decreased by more than 25%, any fixed costs, which are part of the actual costs of the work, should be considered in any computation of actual unit costs. Also, any adjustment of a unit price for minor items decreased more than 25% “shall not be less than the unit price in the original Contract.” Finally, total payment for an item that has been decreased “may not exceed the payment which would be made for the performance of 75% of the Engineer’s Estimate of the item at the original Contract unit price for that time.”

1-501B Part 2 (projects with January 2017 Supplements) Quantity Decreases of More Than 25%

Although the introductory paragraphs of 1.04.02 reference significant changes in the character of work and differing site conditions, Article 1.04.02(b) of the Standard Specifications applies only to minor items. This article outlines the criteria and methods for the adjustment of Minor Item unit prices.

Article 1.04.02(b) states that if a Minor Item is decreased by more than 25% of the original quantity, the Engineer will not adjust the original Contract unit price unless the Contractor makes a written request to the Engineer.

1-501C Eliminated Contract Items

According to Article 1.09.05, if an item or a portion of a lump sum item is eliminated from the Contract, the Engineer is required to give written notice of the elimination to the Contractor.

Article 1.09.05 of the Standard Specifications applies to elimination of Minor Items but refers to article 1.04.03 for significant changes in the character of work.

1-502 Changes in Quantities (of Major Items) and Significant Changes in the Character of Work – Article 1.04.03

“Significant changes” in the character of work shall be interpreted as defined in, and shall only apply to the circumstances detailed in, Article 1.04.03 of the Standard Specifications.

Article 1.04.03 defines the term “significant change” in two ways. The first scenario involves the changes made to the work by the Engineer that materially alter the originally proposed construction. This situation would require recognition by the District Engineer that the work differs materially in kind or nature prior to taking further action to evaluate if there was a cost impact. For this scenario any adjustment should be based on the difference in costs between what the Contractor’s cost would have been prior to the significant change in the character of the work and what the Contractor’s actual costs were after the change. The Contractor’s bid may or may not be a good indicator of the Contractor’s expected costs prior to any change. An independent estimate should be performed.

The second scenario occurs when a Major Item is increased in excess of 125% or decreased to less than 75% of the original contract quantity. In this scenario, the cost for the units in excess of 125% or below 75% of the original Contract quantity should be estimated using the [Major Item Adjustment Worksheet](#) and compared to the price submitted by the Contractor. If there is a documented increase or decrease in the cost of the work, the quantity in excess of 125%, or below 75% of the original Contract quantity should be considered for payment at the revised estimated price.

If additional guidance is necessary to determine whether a Department directed change constitutes a “significant change” under the Contract, the Assistant District Engineer or District Engineer should consult the OOC Transportation Principal Engineer of Claims and Litigation (TPE-Claims). If a significant change is recognized, the Standard Specifications require an adjustment to the contract, excluding loss of anticipated profits. The District should attempt to arrive at a mutually agreeable price adjustment with the Contractor. If an agreement cannot be made prior to the work being performed, the District should determine and apply an adjustment that they believe is “fair and equitable.”

The cost-plus markups for overhead and profit (20% of labor and 15% of material) should not be used when adjusting a Major Item. Instead, if there is an increase in costs due to the reasons stated above, an additional 10% should be added to the labor and material costs (increased portion only) to compensate the Contractor for overhead and profit. For adjustments involving equipment costs estimated to be under \$100,000, Blue Book rates may be used and no markup should be applied to the equipment (increased portion only) for overhead and profit. For adjustments involving equipment costs estimated to be in excess of \$100,000, the District should consult the OOC TPE-Claims who will determine if an audit of the equipment costs is necessary.

If an audit of the equipment cost is performed and actual equipment costs are used, then the 10% should be applied to the labor, equipment, and materials (increased portion only) to compensate the Contractor for costs, including but not limited to, all safety and other equipment, small tools, labor, subcontractor quotes, consumables, field office overhead, home office overhead, insurance, bonding, and profit. If the Contractor disputes that 10% does not adequately compensate them for their expenses, the Contractor may submit additional information to support their additional costs. Payment for additional overhead and profit in excess of 10% must be discussed with the OOC TPE-Claims.

The District Engineer is the approval authority for Adjustments to Major Items or Significant Changes in the Character of Work for sums, which the District can justify, not to exceed \$250,000.

The District must receive concurrence from the OOC Division Chief or Construction Administrator in accordance with Chapter 15 of this manual for all adjustments to Major Items, which, in the aggregate, exceed \$250,000.

This concurrence will be documented by memorandum or e-mail unless the approval letter sent to the Contractor is signed by the approval authority.

1-503 Differing Site Conditions – Article 1.04.04

Under Article 1.04.04 of the *Standard Specifications* "... if subsurface or latent physical conditions are encountered at the Site differing materially from those indicated in the Contract or if unknown physical conditions of an unusual nature, differing materially from those ordinarily encountered and generally recognized as inherent in the work provided for in the Contract..." then an adjustment to the Contract may be necessary. This language is federally mandated for all federally funded projects.

Article 1.04.04 also contains two limiting statements. The first requires the contractor to provide a written notice before the "differing site condition" is disturbed and before the affected work is performed. The second notes no contract adjustment will be allowed under this clause for any effect caused on unchanged work. If the Assistant District Engineer or District Engineer require additional support related to interpretation of these statements they may contact the OOC TPE-Claims, or the OOC Construction Division Chief.

The remainder of this section explains the requirements for determining whether a differing site condition request is valid. Section 1-504 explains the review and approval process of a proposed adjustment to the Contract. The District personnel evaluating a request based on an alleged differing site condition should review all of this information.

Possible causes for differing site conditions may consist of the following:

1. Subsurface Conditions
 - Unanticipated Rock
 - Unanticipated Groundwater
 - Buried structures not shown on the plans
 - Hazardous or contaminated material not identified in the Contract
2. Other physical conditions
 - In rehabilitation projects:
 - Concealed decay
 - In demolition projects:
 - Concealed reinforcement

Differing Site conditions are generally categorized as either Type I or Type II requests, each of which rely on different criteria and validation methods.

1-503A "TYPE I" Differing Site Conditions

Under a Type I request, the Contractor is entitled to an adjustment if it encounters subsurface or latent (not obvious) physical conditions at the site differing materially from those indicated in the Contract.

The courts have articulated various tests for Type I requests. Generally, a contractor must show that all of the following conditions are met:

1. Contract documents indicate the subsurface or latent conditions forming the basis of the request.
2. The Contractor's interpretation of the Contract documents is reasonable.
3. The Contractor must have relied on the indications of the subsurface or latent conditions in the Contract.
4. The subsurface or latent conditions actually encountered at the site must materially differ from those represented in the Contract.
5. The actual condition encountered must have been reasonably unforeseeable.
6. The costs requested must be solely attributable to materially different subsurface conditions.

The following types of contract documents constitute “representations”

1. “Existing conditions” drawings
2. Structures to be demolished
3. Buried utilities
4. Contours, waterways
5. Reports of Subsurface investigations
6. Boring logs
7. Geotechnical report
8. Environmental Investigation

1-503B “TYPE II” Differing Site Conditions

Under a Type II request, the Contractor is entitled to an adjustment if it encounters an unknown and unusual condition that is materially different from that ordinarily encountered.

A Type II analysis is not concerned with representations in the Contract. The focus is on what was actually encountered compared to what is normally or usually encountered at a like jobsite. The Contractor must prove that what is encountered was not normal but, in fact, unknown and unusual. It must be a condition that reasonably could not have been anticipated by the Contractor from a study of the Contract documents, by site investigations, or by the general experience of the Contractor. The lack of contractual representations regarding the jobsite in a Type II case makes the Contractor's burden of proof more difficult to meet.

To prevail in a Type II case a contractor must prove:

1. Under normal circumstances, what conditions would a contractor predict at the site?
2. What physical conditions were actually encountered?

3. The physical conditions actually encountered differed materially from the known and the usual.
4. These conditions caused an increase in the cost of performance of the work.

The language of the differing site conditions clause states the existence of a Type II condition must have been unknown to the Contractor. The request will be denied if the Contractor knew or should have known of the existence of the condition.

1-503C Differing Site Condition Definitions

Materially Different

Arbitrators and courts have a difficult time determining if the condition encountered is "materially different" from that indicated in the Contract. The materiality analysis in Type I requests is somewhat less complex than that in Type II requests. In a Type I request, there is some contract indication to compare with the encountered condition. This indication, although it may not be as specific as a quantity or percentage, is usually more evident than determining what is "usual" for the standard of comparison of a Type II request.

The easiest way to determine materiality in a Type II request is to compare what the Contractor could have reasonably expected to encounter against what was actually encountered and determine whether this difference caused a change in the Contractor's method.

The "materiality" standard reflects the expectation that the Contractor is never assured that everything on the job will go just as planned. Only variations outside of the norm will be grounds for extra compensation.

Foreseeability

To be compensable, subsurface or latent physical conditions encountered must not only differ materially from the Contract indications, but also must be reasonably unforeseeable on the basis of all information available to the Contractor at the time of bidding. The condition must not have been anticipated by the Contractor from a study of the Contract, inspection at the site, and general experience.

For example, in requests of unusual weather, one norm is that weather patterns from the last 10 years are considered foreseeable.

Reliance

Reasonable reliance is an essential element of a differing site condition. A contractor requesting a differing site condition will not be successful, even if the site conditions vary from the Contract, unless the Contractor reasonably relies on the Contract's assertions as to the condition. This requirement is typical of most misrepresentation claims. If the Contractor did not reasonably rely on the contract indications, it did not suffer damages as a result of them and therefore cannot recover.

A common area of dispute is over the Contractor's duty to investigate public records of past work at the site. Sometimes there are records available at, for example, a town engineer's office. Even if the owner has not reviewed those records and disclosed them to contractors, the owner may argue that the Contractor has a duty to look at such documents before arriving at conclusions about the site.

Unusual condition (Type II Request)

A condition that might not reasonably be anticipated based on the contract work and the location at which it was to be performed. A contractor is not entitled to expect the most favorable conditions, but it need not

anticipate the worst. Generally, the more extreme the condition, the easier it will be for the Contractor to prevail on its request.

1-503D Examination of Site Clauses

CTDOT contracts require the Contractor to visit the site and become familiar with conditions there. Any condition, which would have been seen in a pre-bid inspection, will be deemed to have been "disclosed" to the bidder. Disputes may arise over what level of site inspection the bidder should make, and whether it includes uncovering of work to see "hidden" conditions.

Contractors are expected to look closely at important parts of the project during the site inspection, but are not expected to perform invasive work to uncover hidden conditions.

1-504 Differing Site Condition Contract Adjustment Approval

Once the District establishes that a "differing site condition" is apparent, an attempt should be made to arrive at a mutually agreeable adjustment to the Contract with the Contractor. If an agreement cannot be made prior to the work being performed, the District Engineer shall make such an adjustment that is "fair and equitable." **For an adjustment to be warranted, the increase or decrease in costs must be due solely to the significant change in the character of the work caused by the differing site condition. If the costs or change in conditions are not clear to the District Management they should seek assistance from the OOC TPE-Claims.**

The cost-plus markups for overhead and profit (20% of labor and 15% of material) should NEVER be used in this scenario. An additional 10% should be added to compensate the Contractor for overhead and profit. For adjustments involving equipment costs under \$100,000, Blue Book rates may be used and no markup should be applied to the equipment for overhead and profit. A markup of 10% should be added to the labor and material costs to compensate the Contractor for overhead and profit. For adjustments involving equipment costs estimated to be in excess of \$100,000, the District should consult the OOC TPE of Claims who will determine if an audit of the equipment costs is necessary.

If an audit of the equipment cost is performed and actual equipment costs are used, then the 10% should be applied to the labor, equipment, and materials to compensate the Contractor for overhead and profit. If the Contractor disputes that 10% does not adequately compensate them for their expenses, the Contractor may submit additional information to support their additional costs. Payment for additional overhead and profit in excess of 10% must be discussed with the OOC TPE of Claims.

The adjustment should be based on the difference in costs between what the Contractor would have spent prior to discovery of the significant change in the character of the work and what the Contractor's actual costs were after the change. The Contractor's bid may or may not be a good indicator of the Contractor's expected costs prior to any change. An independent estimate should be performed.

The District Engineer is the approval authority for Differing Site Conditions which the District can justify, not to exceed \$250,000. In these cases, the District Engineer should document their approval by signing the letter to the Contractor or by some other means.

Differing site condition requests which in the aggregate exceed \$250,000 must be forwarded to the OOC Division Chief for concurrence. In these cases, the District must perform an initial review and recommend a resolution to the OOC Division Chief. The OOC Claims Section will review the information provided. It may be determined that the recommendation is acceptable or that further information is required. If necessary, an independent Certified Public Accountant may be engaged to review cost information.

OOO Division Chief concurrence will be documented by memorandum or e-mail.

1-505 Adjusted Price Forms for Major Items, Change in Character of Work & Differing Site Conditions

Forms that are used to calculate adjusted prices for Major Items due to change in the character of work and differing site conditions can be found in ProjectWise within the 04.1 – Construction Libraries >04.200 - Approved Forms folder.

Use the following form for an adjustment greater than \$100,000 that requires an equipment audit:

[ADJUSTED PRICE MORE THAN \\$100,000 with OOC equipment audit](#)

Use the following form for an adjustment less than \$100,000 that does not require an equipment audit:

[ADJUSTED PRICE LESS THAN \\$100,000](#)

Chapter 6 - Extra and Cost-Plus Work

1-600 Extra Work Determination

For Federal Transit Administration (FTA)-funded projects there are additional requirements, see end of Section.

Extra work is unforeseen work made necessary by changes to the Contract, or work that is necessary for completion of the project, but for which no price is provided in the Contract. Articles 1.04.05 and 1.09.04 of the Standard Specifications provide the basis for administering extra work.

In order to analyze whether work is included in the original Contract, changed original Contract work, or extra work, personnel need to understand all the Articles in Section 1.04, Scope of Work, of the *Standard Specifications*. They also need to be familiar with the entire Contract. Articles 1.04.02, 1.04.03 and 1.04.04 are further discussed in detail in Chapter 5.

District personnel should carefully review Contract Documents (Addenda, Special Provisions, Permits, Plan Sheets, Construction Orders, etc.) to evaluate whether the work is included in the original Contract items or the general cost of the Project. In case of conflict between the Contract plans and/or Contract provisions, the order of governance among the Contract requirements is determined in accordance with 1.05.04 of the *Standard Specifications*. Any requests from the Contractor for payment of delay-related direct costs including additional general conditions and indirect costs (field office overhead or home office overhead) must be brought to the attention of the Transportation Principal Engineer (TPE) who oversees the Claims and Litigation Section (TPE-Claims) in the Office of Construction (OOC) for determination.

Work perceived by inspection staff or the Contractor to be new or unforeseen work may not necessarily be extra work; therefore, it must be discussed and approved by the Assistant District Engineer (ADE).

Once a determination is made that work is extra work, the District must establish or incorporate specifications and determine the Method of Measurement and Basis of Payment for the extra work. The preferred method of compensating the contractor for extra work is through an agreed price. The agreed price method is more efficient in comparison to the cost-plus method.

When, in the opinion of the Assistant District Engineer (ADE), the extent of extra work cannot be reasonably estimated; there is insufficient time to negotiate an agreed price; or price negotiations are at an impasse, the ADE may determine that the work is to be performed on a cost-plus basis. If this determination is made, the District is to issue a letter from the ADE to the Contractor outlining the work as explained in Section 1-602. The basis for this determination must be documented in the project records.

When there are items in the original Contract that apply to the extra work, payment is made at the original contract item price unless there has been a significant change in the quantity or character of the work. Refer to Chapter 5.

Budget and Scope Analysis: The first step in the process of incorporating extra work is for the Project Engineer (PE) to evaluate the impact of the extra work to the Project's schedule and funding and initiate a project modification request if necessary. In order to complete funding analysis, the District must determine whether the work is or is not within the scope of the Project, prepare a cost estimate, and, for projects with federal funds, determine federal eligibility. District personnel must review Chapter 8 of this manual for standard procedures related to construction orders, changes in scope, and federal eligibility.

The Department's request for the proposed price should also advise the Contractor that if a time extension is required, based on an impact to the critical path, it should be included in the proposal. The request should also include the specification(s) and other required criteria. Following the request for an agreed price the District should proceed according to Section 1-601 of this chapter.

FTA Funded Projects:

For FTA-funded projects the use of cost-plus to pay for extra work is discouraged, but if a price cannot be agreed upon, all the following documentation must be placed in the Project records:

- Determination that work must proceed prior to agreement on price in order to avoid delay,
- Determination that the extra work price negotiations are at an impasse, and
- A copy of the Notice to Proceed to the Contractor for the extra work that includes the ceiling price that the Contractor is not to exceed except at its own risk.

1-601 Agreed Price

Except as otherwise stated in the Project specifications, the ADE and Contractor must agree on the amount of compensation before an agreed price item can be incorporated into the contract.

When it is necessary to add a new work item to the contract, the Department is to prepare a cost estimate for that work. When such estimate is prepared by Design, the District is to evaluate the estimate and determine if any adjustment of price(s) is warranted.

Methods used by the Department to prepare cost estimates include:

- weighted unit prices;
- average bid price information from similar projects along with anticipated quantity;
- estimate using a [Cost Analysis Sheet](#) (in the description indicate this as a Scope Analysis);
- other cost estimating resources approved by the ADE or TSE, i.e. Means estimating books.

Regardless of the method used, the cost estimate should be prepared, signed, and dated, in advance of receiving a proposed price from the Contractor. The Department's estimate is a starting point for negotiations with the Contractor and is to be included in the project records. For FTA funded projects this requirement is mandatory.

Upon receipt of a response from the Contractor to the request for a price for work, the project staff or PE will review the Contractor's proposal, including time adjustment request when applicable, and recommend whether the proposal is acceptable. The requirements related to time adjustment justification and analysis are covered in Chapter 7 – "Time Extensions and Suspensions."

If the ADE and the Contractor agree prior to the work commencing, a portion of the work may be monitored to establish a unit price or lump sum. The PE and Chief Inspector (CI) should make sure the production rate is consistent with the normal industry practice. The work must be tracked on a cost-plus basis during this period.

If negotiation of a price for the work is unsuccessful, the ADE may elect to proceed on a cost-plus basis (see Section 1-602).

If an agreement has been reached on a price, the District prepares a letter for the ADE's signature to authorize and state the conditions of the extra work. The conditions should include, at a minimum, the agreed price, applicable specifications, any special conditions, and the Department's position related to contract time. The letter should reference Article 1.04.05 of the *Standard Specifications* for authority and to enforce what costs are included in the price.

The CI should process a construction order to establish an item for the work immediately after receipt of the letter from the ADE to the Contractor authorizing the work. The price justification form(s) and calculations used to justify the agreed price must be included in the project files. For further guidance related to preparing construction orders refer to Volume 1, Chapter 8 – "Construction Orders."

1-602 Cost-Plus

Following the budget and scope analysis outlined in Section 1-600, and if the ADE determines that the extent of extra work cannot be reasonably estimated or an agreed price cannot be reached, an order to perform the extra work in accordance with Article 1.09.04 of the *Standard Specifications* – “Extra and Cost-Plus Work” may be issued by the ADE.

Initiating Cost-Plus Work:

Once a determination is made that extra work will be performed on a cost-plus basis, the project staff or PE will draft a letter for the ADE’s signature directing the Contractor to perform the extra work on a cost-plus basis. The letter is to include:

- a description of the work;
- a statement if the Contractor feels that the work affects the critical path of the project that they are required to submit in writing a request for a time extension;
- the governing specifications;
- direction to the Contractor that they need to identify in writing equipment that needs to be brought to the site exclusively for the cost-plus work, equipment that must be rented, and proposed use of overtime to complete the cost-plus work for the PE’s approval;
- a statement that the workforce and equipment must be approved by the PE prior to the Contractor preparing for the commencement of the work;
- any other special conditions.

The calculation sheet(s) that produced the anticipated costs should be included in the project records.

There are two exceptions to the procedure outlined above when there is a need to perform work that is potentially cost-plus with little or no notice:

- In the event there is not adequate time to send a letter directing the work on a cost-plus basis but there is time to consult the ADE and determine the work is extra work, advanced authorization may be given to the Contractor to perform the work on a cost-plus basis. The Supervising Engineer, PE and/or Inspection Staff will issue a field directive subject to limits established by the ADE.
- When there is an emergency and supervisory staff cannot be contacted, the project staff may issue a field directive to the Contractor to perform the work. The field directive should state that the work will be tracked as if it were cost-plus work, but the final determination related to payment method will be made at a later time. As soon as possible, the project staff must inform the supervisory staff of the emergency and provide the details of the work so the analysis of whether it is extra work may be completed.

If one of the two exceptions noted above are encountered, a letter should be prepared as soon as possible to the Contractor signed by the ADE, confirming the cost-plus payment method and any other conditions of the extra work or notifying them that the Department has determined the work is not extra work.

When there is a contract specification that states the Method of Measurement/Basis of Payment is in accordance with Article 1.09.04 of the *Standard Specifications*, the letters and approval from the ADE are not required. The District should inform the Contractor of the new item(s) being added based on the specifications and inform them of the requirements for cost-plus work.

The PE is responsible for the approval of the labor, equipment, and material to be used for the cost-plus operation. The PE should discuss the following with the Contractor:

- whether overtime is required for the operation.
- whether contractor-owned equipment must be brought to the site or equipment must be rented specifically for the cost-plus work.

The requirements relative to labor and equipment are explained in detail in Article 1.09.04 of the *Standard Specifications*. Additional guidance is provided relative to labor, cost of supervision, equipment, and other specific topics later in this chapter. The conversation regarding appropriate resources to complete the work should be held before the Contractor starts preparation for the work.

Normally, supervisory personnel above the grade of foreman will not be included as labor in the cost-plus calculation as those positions are included in the cost of the overhead and do not appear on the certified payrolls. Approval for the direct labor payment of persons above the grade of foreman must be obtained from the ADE.

The PEmay delegate the initial conversation and agreement with the Contractor regarding labor, equipment, and materials to be used to the CI.

Procedures for Administering Cost-Plus Work:

Cost-plus operations require adequate oversight to accomplish the inspection of the physical work as well as document the contractor resources used (as explained below). The documentation for each day should include a Labor, Equipment, and Material Daily Report (LEMDR) and a Daily Work Report (DWR).

Prior to the Contractor commencing cost-plus work, the Inspector should verify the approved workforce, equipment, and if overtime is approved. In addition, documentation to substantiate reasonable mobilization costs that are exclusively required for cost-plus work should be obtained.

Daily Work Report

- The Inspector must record observations and inspections of cost-plus work in the SiteManager DWR. See the SiteManager user guide for appropriate guidance related to data entry.

Labor, Equipment, and Material Daily Report (LEMDR):

- The Inspector assigned to oversee a cost-plus operation will complete the LEMDR for each day (or if more than one work shift is completed in one 24 hour period the LEMDR should be completed for each work shift) that cost-plus work is performed and have it signed by the Contractor's representative at the end of the day or work shift. (Note: LEMDRs should also be filled out daily if the District is "tracking work on a cost plus basis" because of a possible dispute over a price or for other reasons.)
- The LEMDR form is available from the Approved Forms located in ProjectWise, (Documents - 04.1 - Construction Libraries - 04.200 - Approved Forms and Inspection Checklists). Look for the file with the description, "Labor Equipment Material Daily Report". This form must accurately document the labor, equipment and material used for the cost-plus work for the day.
- Prior to signing, the Inspector should compare the LEMDR to the Contractor's daily record for the cost-plus work and note any discrepancies on the LEMDR. If the Contractor refuses to sign the daily report or does not provide a record for comparison, note this on both the LEMDR and DWR.
- It is highly recommended that the Inspector record the name of each person involved in the cost-plus work on the LEMDR. This will make the completion of the final cost-plus payment calculations easier by allowing identification of the appropriate labor rates by employee name from certified payrolls.

- The handwritten LEMDR must be kept with the cost-plus records as support for the final cost-plus calculations.

Payments:

- The first cost-plus payment should be made as soon as possible (within the same month as the work begins), however payment cannot be made until the implementing construction order has been processed.
- When supporting documents are missing, the Inspector will determine an estimated progress payment by using available information such as LEMDRs, DWRs, previously submitted certified payrolls, prevailing wage scales, previous insurance and tax premiums, subcontracts, invoices, area prices for materials, etc.
- Progress payments should be made at 100% of what the Inspector estimates with a contract line item adjustment of a minimum of 10% withheld until the Contractor furnishes all required documentation necessary to finalize the cost-plus payment. For example, a payment adjustment should be applied if payrolls have not been submitted and/or material invoices are not properly received. Withholdings for material testing should be handled in the same manner as with other items.
- Progress and final payments for cost-plus work are to be calculated by completing a Cost-Plus Summary Sheet or Cost-Plus Workbook.
- The Cost-Plus Summary Sheet is used for cost-plus operations of a short duration (i.e. 1 to 2 days).
- Cost-Plus Workbook is used for cost-plus operations of 3 consecutive days or more. Each Cost-Plus Workbook is limited to a maximum allowable period of one month (31 days).
- The completed forms for estimated payments shall be kept in the same binder as the final cost-plus documentation and referenced accordingly from the DWR.
- When a Cost-Plus Summary Sheet or Cost-Plus Workbook is used for a progress payment, the form must indicate that it is for progress payment purposes.
- All cost-plus payments will be made to the nearest whole dollar.
- The description for the payments in the DWR should be, “Estimated Progress Payment,” or “Final Payment” as appropriate.
- If a subcontractor performs cost-plus work, an administrative mark-up is applied to the amount due to the subcontractor and paid to the Prime Contractor. Refer to Subsection 1-602E - “Administrative Expenses” for specific guidance.
- Prior to processing the final cost-plus payment, the Inspector must prepare the final Cost-Plus Summary Sheet or Cost-Plus Workbook and have another inspector verify the information recorded substantially agrees with the signed LEMDRs, certified payrolls, insurance and tax premiums, receipted bills and allowed equipment rates. The electronic calculations must also be checked in accordance with the guidance in Chapter 3 of this manual.
- Discrepancies found during the verification process that if corrected do not increase or decrease a total calculated cost-plus amount by more than 0.5% do not require correction of the calculation; the discrepancy only needs to be noted.
- The final cost-plus sheets do not have to be forwarded to the Contractor unless requested.

Project Engineer Review:

- Project Engineers must review the project records periodically to assure that cost-plus payments are current and note this review by signing the Cost-Plus Summary Sheets or Cost plus Workbook. Particular attention should be given to the signed LEMDRs and associated DWRs that document the labor, equipment, and material used.

Cost-Plus Documentation:

All documentation required to support and perform the calculation of the cost-plus payment amount should be maintained in one place. The organization of the supporting documentation should use the Volume III numbering system. If software is used for computing values, the files may be checked and stored in accordance with Volume 1 Chapter 3 of the Construction Manual and do not have to be printed on paper. This includes:

- The LEMDR
- Cost-Plus Summary Sheet or Cost-Plus Workbook for payment calculations
- Representative certified payrolls that document the labor rates in conjunction with the Cost-Plus Summary Sheet or Cost-Plus Workbook to calculate the payment for the cost-plus work. See Subsection 1-602A - "Labor Rates" for further guidance. For cost-plus operations that extend more than one payroll period, the Inspector should verify that the rates used and the number of hours worked recorded on the cost-plus sheets agree with the appropriate payroll. Additional payrolls only need to be included when rates change.
- Documentation of the cost of insurance and taxes. See Subsection 1-602B - "Labor Additives" for specific guidance related to insurance and tax mark up.
- Quotes for specialized work (if quotes were requested). See Subsection 1-602D - "Specialized Work" for specific guidance related to specialized work.
- Copies of receipted invoices (bills) indicating payment for all materials, rented equipment, and if applicable, specialized work.
- For final cost-plus backup the receipted invoices (bills) shall consist of itemized invoices, which identify the actual cost of materials, rented equipment, or specialized work, as well as additives and credits such as, but not limited to, taxes or volume discounts.

Acceptable forms of receipted invoices include:

- Copies of cancelled checks with copies of corresponding invoices
- Invoices marked "Paid in Full" and signed by the Vendor
- Invoices stamped "Paid" with the Contractor's corresponding check number noted and a copy of a bank statement showing the check was paid
- Letter or affidavit from the vendor identifying specific items for which full payment was received with copies of the invoices
- Copies of virtual credit card payment verifications with copies of the corresponding invoices
- A copy of the store or vendor's receipt if a credit card was used

Affidavits for materials taken out of the Contractor's stock, certifying material quantities and prices claimed. The affidavits must include a statement that the claimed prices for the materials represents the current fair market value.

Quotes for rental equipment (if quotes were requested prior to the use of the equipment)

Worksheets documenting the allowable equipment rates (determined from the applicable rental rate source used by the Department). See Subsections 1-602H to 1-602I for further guidance related to equipment rates.

Note: Contractor's cost-plus sheets or Daily Time Reports are not acceptable as back-up for payment

1-602A Labor Rates

Labor rates refer to the base labor rate and fringe benefits as shown on the certified payroll. Also discussed in this section are the labor burden mark-ups on labor rates and the appropriate procedures for the calculation of the labor portion of the cost-plus payment.

When preparing the Cost-Plus Summary Sheet or Cost-Plus Workbook for payment calculations, the Inspector must use the rates of pay and fringe benefits shown on the certified payroll. Even though the Contractor is ultimately responsible to ensure appropriate wage rates are paid to employees based on the type of work performed, the Inspector should verify that the employees' classifications are appropriate for the work performed and the rates of pay are at least equal to the Contract's applicable prevailing wage rates. If there are concerns regarding the rates shown on the certified payroll, the Chief Inspector should discuss it with the Project Engineer and initiate the resolution of the discrepancy with the Contractor. If the amount of compensation is incorrect, the Contractor must submit a revised payroll and provide proof of payment to the employee. Refer to Volume 1, Chapter 12 – "Civil Rights."

If cash benefits are shown on the certified payroll, they are to be included in the cash or base payment section of the cost-plus calculation sheet.

If overtime is authorized for cost-plus work, the labor rates must be handled differently. There will be a difference in the labor burden mark-up for the half time or double time portion of the time and a half or double time pay.

See Subsection 1-602B - "Labor Additives" for specific guidance related to insurance and tax markups.

The compensation for overhead (field and home office overhead) and profit is addressed in the specification for cost-plus work. If there is confusion regarding overhead and profit, the project staff should consult the Supervisory Staff in the District.

1-602B Labor Additives

This section outlines the application of labor additives for insurance and taxes, fringe benefits, and overhead and profit.

The fringe benefits are paid to, or on behalf of, the employee by the Contractor. The rate applied to cost-plus work should be acquired from the certified payroll. The rate varies by labor classification and includes, but is not limited to, health insurance; pension or retirement; life insurance; disability; vacation; holiday; and union dues. With the allowance of different certified payrolls there may be some inconsistency in reporting of the rates on the certified payrolls. If there are issues determining the appropriate rates, the Project Staff should discuss the issue with the PE and request an explanation from the Contractor.

The mark-up for insurance and taxes is intended to compensate the Contractor for taxes and insurances required for the work but not compensated for in other ways. For example, the cost of insurance for equipment is included in the Blue Book rates. The cost of the vehicles for Supervisory Staff above the grade of foreman is generally overhead and should not be considered unless the Superintendent is approved for direct payment as labor.

The Labor mark-up (see the *Standard Specifications* Article 1.09.04 for actual %) for overhead and profit includes field and home office overhead as well as other costs of the work. The Project and District staff should review the language of this Chapter and that of Article 1.09.04 of the *Standard Specifications* to be aware of the costs that are included.

Insurance and Tax Rate Submission:

The Contractor should provide the insurance and tax rates for straight time and overtime work at the Preconstruction Meeting, using the Labor Mark-Up for Insurance and Taxes form available from ProjectWise

(Documents - 04.1 - Construction Libraries - 04.200 - Approved Forms and Inspection Checklists).

It is recommended that the District reference and attach a copy of this form to the written notice of the Preconstruction Meeting transmitted to the Contractor. If it is anticipated that a subcontractor will perform cost-plus work the form should be submitted by the subcontractor prior to the start of the cost-plus work. A copy of the insurance and tax rate form submitted by the Contractor is to be kept in the applicable Volume or binder with each cost-plus item.

Insurance and tax rates may change depending on insurance policy periods, the safety record of the Contractor, government actions, etc. At a minimum, the insurance and tax rates should be updated annually. As stated in the Labor Rate section of this Chapter, insurance and tax costs associated with straight time and overtime are different.

The insurance and tax submittal should be signed by an officer of the company (Prime and Subcontractors) and addressed to the ADE. If the Labor Mark Up For Insurance and Taxes form is not used, the submission must at least be in the form of a letter that includes itemized straight time and overtime rates for the applicable categories such as:

- Worker's compensation rate*
- General Liability insurance rate*
- Social Security (FICA) rate
- Medicare
- State unemployment insurance rate
- Federal unemployment insurance rate

*A copy of the "Declaration Sheet" from their insurance company or a notarized letter certified by an officer of the company for self-insured contractors should accompany the form.

Review of Tax and Insurance Submissions:

The intent of the Department is to use an average or blended rate for general types of work that may be performed in accordance with the cost-plus system of payment. The general types of work are:

- roadway work or general building construction
- elevated bridge work (does not necessarily apply to buildings)
- iron work (structural steel and rebar by ironworkers)
- bridge (or building) painting or similar work.

There are two significant variations in the rates that should be expected. The first is the variation with the type of work and will occur because of varying Workers Compensation rates and the liability rates. The second is the variation from contractor to contractor and will occur because certain rates decrease or do not apply to overtime and because certain rates apply to the straight time portion but not the premium portion (1/2 time) of the overtime.

The Social Security (FICA), Medicare, and federal unemployment insurance rates are set by the government. State unemployment rates vary based on the experience of a given contractor.

The project staff shall use the following evaluation procedure for all cost-plus tax and insurance submissions:

- Make sure the submission complies with the guidance above.
- Evaluate the expected type of work and categorize it into one or more of the following categories:
 - roadway work (or ground work for buildings)
 - elevated bridge work (does not necessarily apply to buildings)
 - iron work (structural steel and rebar by ironworkers)
 - bridge (or building elevated) painting or similar work

- Ensure the rates for vacation, holiday, sick leave, union dues, etc. (Health Welfare and Pension) do not appear in the itemized insurance and tax breakdown. If they do strike them out, recalculate the total and move to the next step.
- Ensure that the rates for insurance of equipment and other vehicles do not appear in the itemized insurance and tax breakdown. If they do strike them out, recalculate the total and move to the next step. Insurance rates for equipment are included in the Blue Book rates. Insurance rates for vehicles for Superintendents and above is included in overhead.
- If the estimated labor portion of the cost-plus work is over \$500,000.00, the District must contact the OOC Claims and Litigation Section. The Claims and Litigation Section will work with the District personnel to obtain the necessary information and review the rates to determine if they are acceptable or if an audit is necessary.
- If the labor portion of the cost-plus work is estimated to be less than \$500,000.00 the following thresholds apply:
 - Straight Time Rate
 - (1) If the work is roadway work (ground work for buildings) and the total insurance and tax rate is less than 50% it is acceptable.
 - (2) If the work is elevated bridge work excluding iron work (erection of structural steel, placing rebar, etc.) and painting and the total insurance and tax rate is less than 60% it is acceptable.
 - (3) If the majority of the work is elevated bridge or building iron work and the rate is less than 85% the rate is acceptable.
 - (4) If the work is primarily bridge (or building) painting or similar work and the insurance and tax rate is less than 100% it is acceptable.
 - (5) If none of the above are true the District should request narrative justification of the rate, with supporting information, such as copies of itemized insurance quotes for General Liability and Workers compensation, from the Contractor. The District may contact the OOC Claims and Litigation Section.
 - Overtime Premium Portion Rate and Double Time Portion Rate:
 - (1) The overtime premium portion rate should be less than the straight time rate.
 - (2) A table is included below (Figure 1-6.1) to be used by the field staff to evaluate the overtime rates.
 - (3) If there are any questions related to the application of the Figure or the overtime rates, the PE should consult the Claims and Litigation Section.
 - (4) A second calculation for overtime is necessary due to the different rates. See the applicable (approved) Cost-Plus calculation spreadsheet(s) for instructions.
 - If the rates exceed those of the thresholds stated, check the Workers Compensation and the liability Insurances:
 - (1) Check the liability insurances provided by the Contractor. The *Standard Specification* for cost-plus (Article 1.09.04) makes a broad statement regarding liability insurance, but if the Contractor is required to carry general liability insurance per Article 1.03.07 of the *Standard Specifications* or a special provision, consider if it is required for the completion of the cost-plus work or project. Automobile and other equipment-related insurances are not to be included in the General liability rate. If it is unclear whether the liability insurance is required for the cost-plus work, or if a liability insurance appears in the itemized list but does not appear to be necessary for the work or the project (for example, marine or railroad liability), the question should be raised to the PE who again may contact the TPE-Claims for guidance.
 - (2) Check that the workers compensation rates use the appropriate categories for workers compensation and that the Contractor is applying the adjustment factors correctly to calculate the rate. If there are questions related to this calculation the PE may contact the TPE-Claims for assistance.

- If the rate remains unchanged or the recalculated rate is still above the thresholds, the project staff should discuss the next steps with the PE. The next steps may involve requesting an explanation from the Contractor. The PE may choose to contact the TPE-Claims for guidance.

Review of Fringe Benefits:

Normally, the Fringe Benefit rates are obtained directly from the certified payroll. However, if overtime is authorized and used for the cost-plus work, the Inspector should verify that the rates applied to the overtime are accurate. See Figure 1-6.1 below for fringe benefits that do not apply to the premium portion of the overtime.

Figure 1-6.1 Premium Time & Double Time Labor Additives Tax, Insurance and Fringe Benefits

Additive	Straight Time Portion	Premium Portion	Double Time Portion	Effect
Insurance and Tax Additives				
General Liability Insurance	Yes	No	No	Not applied to premium/double time portion ⁽¹⁾
Workers Compensation	Yes	No	No	Not applied to premium/double time portion ⁽¹⁾
Social Security	Yes	Yes	Yes	6.2% of all premium/double time ⁽³⁾
Medicare	Yes	Yes	Yes	1.45% of all premium./double time ⁽³⁾
State Unemployment	Yes	Yes	Yes	1.9% to 6.8% of all premium/double time ⁽³⁾
Federal unemployment	Yes	Yes	Yes	0.6% to 1.8% of all premium/double time ⁽³⁾
Fringe Benefits				
Health Insurance	Yes	No	No	Not applied to premium/double time portion ⁽¹⁾
Union Dues	Yes	No	No	Not applied to premium/double time portion ^(1,2)
Vacation	Yes	No	No	Not applied to premium/double time portion ^(1,2)

- ⁽¹⁾ Example: If someone works 10 hours and has a base pay rate of \$20 per hour (base rate) and they are entitled to time and a half for the time over 8 hours, then the total base rate paid to that person is \$30 (1.5 times \$20) for the 2 hours of overtime. However, the additives for the premium portion (the \$10) are a lower rate. The calculation should be made as follows. The \$20 (straight time) is subject to the add-ons identified on the chart in the Straight Time Portion column for 10 hrs. The \$10 (premium portion) is subject to the Premium Portion additives identified by “Yes” in the Premium Portion column for 2 hrs. If a paper cost plus sheet is used it would require 2 separate sheets. The same principle applies for double time.
- ⁽²⁾ Payment differs union to union, depending on the agreement.
- ⁽³⁾ It is possible these rates could be adjusted by the Government. If a contractor challenges the rates please contact the OOC Claims and Litigation Section for guidance.

1-602C Bonding Costs

The Bonding Costs associated with cost-plus work are compensated through the mark-up in the labor section of the cost-plus calculation. If there are questions regarding bonding, the PE should discuss the issue with the District Supervisory Staff. Increased bonding requests associated with time extensions are delay-related overhead requests and therefore must be forwarded to the TPE-Claims for evaluation.

1-602D Specialized Work

Specialized work is work requiring skills, tools, and equipment substantially different than those ordinarily used by the Contractor and its subcontractors.

Approval from the ADE must be obtained before classifying work as specialized. Prior to performing such specialized work, the Contractor must obtain and submit a minimum of three price quotes for the work, if requested by the Engineer. For specialized work, the Contractor will be reimbursed its actual costs, plus administrative expenses per the *Standard Specification* for cost-plus work.

Specialized work does not relieve the Contractor of other contractual requirements such as, but not limited to, requests to subcontract and certified payrolls.

1-602E Administrative Expenses

In the case of a subcontractor performing cost-plus work, an additive is applied to the compensation for the subcontracted work. This additive is intended to compensate the Prime Contractor for administration of the authorized subcontractor work. The administrative mark-up is payable to the Prime Contractor only. The rate of reimbursement for the administrative expenses is stated in *Standard Specifications* Article 1.09.04.

If a specification states that the payment method is in accordance with Article 1.09.04 and also states that the distribution of administrative expenses will be handled in a different way than outlined in Article 1.09.04, the administrative expense may be handled in accordance with that specification.

In some cases the Contractor may be entitled to receive the Administrative Mark-Up when a subcontractor is not involved. For example:

- Reimbursement for opening an asphalt plant if directed by the Department, or tipping fees related to disposal of contaminated material: The Contractor should be reimbursed for opening the asphalt plant at the amount shown on the invoice. The Contractor will receive an additional 7.5% administrative mark-up as well. (The Contractor is not entitled to the 15% mark-up that is paid for materials).
- Purchase of GPS equipment and related training. The Contractor should receive an additional 7.5% administrative markup on the costs of the equipment and related training.

1-602F Small Tools

Small tools or tools of the trade, such as but not limited to, shovels, picks, rakes, ladders, and electric power tools are not normally compensated on a rental or blue book rate basis but are included in the cost-plus mark-ups.

1-602G Contractor-Owned Equipment

Contractor-owned equipment, including equipment owned by a subsidiary, affiliate, or parent company of the Contractor, that has been authorized for cost-plus work is reimbursed at the applicable Blue Book rental rate determined from the source identified in the *Standard Specifications* Article 1.09.04. The compensation for active and idle equipment is substantially different, mainly due to the significant operation costs of equipment. The Inspector should record when equipment is active and when it is idle and apply the appropriate rate in the cost-plus calculations. The applicable rate for idle equipment is outlined in the *Standard Specifications* and Section 1-602H – “Idle Equipment.”

The Blue Book rates reflect a suggested amount an equipment owner should charge during a contractual period to recover equipment-related costs based on a single shift 8 hours/day, 40 hours/week, 176 hours/month basis. The

maximum hourly rental rate allowed by the specification for contractor-owned equipment is the applicable monthly Blue Book rate, divided by 176 (176 working hours per month).

These rates take into consideration normal owner and operating costs for contractor-owned equipment including major overhaul costs; however, the estimated operating cost/hour may not include extraordinary operating costs. The excluded operating costs will be noted on the worksheet. To obtain payment for extraordinary operating costs the Contractor must provide satisfactory documentation of their actual cost. Also, if equipment is assigned to cost-plus work and is consistently working in severe conditions, the Contractor may be entitled to additional payment for maintenance costs. If increased maintenance costs or extraordinary operation expendables are requested, the issue should be discussed with the Supervising Engineer or above.

District field personnel are responsible for obtaining the appropriate Blue Book rate. If there are questions the District Supervisory Staff should be consulted prior to cost-plus work commencing, especially if the Inspector is unfamiliar with the equipment information required. For example, the following information may or may not apply: year; make; model; H.P.; diesel or gas; wheel or track; rollover protection; transmission type; attachments; bucket sizes; lifting capacity. The required information is substantially different for different pieces of equipment, such as cranes and pick-up trucks.

If a rental rate for a particular piece of equipment is not readily available from the Blue Book rate source, the publisher should be contacted to determine if one is available. If they cannot provide a rate, a rate may be established by using rates listed by other publishers, organizations or rental companies or any other method approved by the ADE.

1-602H Idle Equipment

If the equipment is being used as intended, it is active. If the equipment is not being operated, it is idle.

Time during which equipment is idle is reimbursed at 50% of the applicable rental rate, excluding operating costs.

There are two different situations to consider when contemplating idle time that are explained in detail in the *Standard Specifications*:

1. If a piece of equipment is not brought to the site exclusively for cost-plus work then the period of time it is assigned to the cost-plus work starts when the cost-plus work has commenced for that day and is over when the continuous work on that operation is done. Idle time may be considered within that time. If the equipment leaves to perform work that is not cost-plus and returns within the day the period would be only partially compensable or not at all depending on the situation.
2. The other scenario is contractor-owned equipment that has been brought to the site exclusively for cost-plus work. The cost-plus specification is particularly detailed regarding this topic. The Inspector should review the language and discuss any questions with the Project Engineer. To avoid confusion, the Inspector and PE should discuss the possibility of exclusive equipment with the Contractor prior to the authorization of personnel and equipment. This will also be an indication of a need to track the mobilization of this equipment and the start and stop dates. Additionally, if the PE releases the equipment from the cost-plus operation the period of use is considered complete.

1-602I Rented Equipment

The *Standard Specification* Article 1.09.04 contains specific requirements related to Rented Equipment and should be reviewed prior to proceeding.

The PE may approve or direct the Contractor to rent equipment when it is determined the equipment is necessary to perform cost-plus work. The PE should require the Contractor to provide a list of the equipment they have available and the equipment needed to perform the work, as well as the anticipated duration that the equipment will be required. If it is determined that the Contractor does not own the equipment required to perform the cost-plus work, the Contractor must furnish the information required in the cost-plus specification, which includes:

- the specific nature of the rentals;
- the reasons for its need for such rental;
- the anticipated duration of the rental;
- quotes for daily weekly and monthly rates from three rental companies

Due to these requirements, the PE and Inspector should ensure that the requirements are detailed in the letter directing the cost-plus work.

If the rates provided by the Contractor appear high, the Project Staff should compare them to Blue Book rates.

For rented equipment such as excavators and small equipment that will need to be refueled, the fuel costs may not be included in the rental rate. However some equipment, such as cranes, are supplied with fuel included. The Project Staff should check the rental agreement for the details and note the fuel consumption on the LEMDR, if necessary.

Rented Equipment that comes with an operator is not exempt from prevailing wage requirements. The operator must be reported on a certified payroll. Refer to Volume 1, Chapter 12 – “Civil Rights.”

1-602J Materials

The support and payment related to materials used for cost-plus work is explained in detail in Article 1.09.04 of the *Standard Specifications*. The project staff should read and understand these requirements prior to the start of the work.

If the Department pays in full for a material, that material becomes the property of the Department. The District Supervisory Staff should be consulted regarding the handling of surplus material related to cost-plus work. Examples include, but are not limited to, span poles, aluminum signs, rebar, catch basin tops, RCP, or excess steel plates, all which could be delivered to Department Stores and possibly used by Department Maintenance. An alternative to the Department taking ownership of the material is for the Department to receive a reasonable credit for salvage from the Contractor. Approval to receive salvage credit must be given by District Supervisory Staff.

If the Contractor is also the producer of the materials, or they possess acceptable material in their stock, they must provide a notarized affidavit or a letter signed by an officer of the company in accordance with the cost-plus specification.

Sales tax included on invoices for work permanently incorporated into the project will not be reimbursed. It is the Contractor’s responsibility to obtain the Contractor’s Exempt Purchase Certificate from the State of Connecticut, Department of Revenue Services (CERT-141). Materials that are not permanently incorporated into the work are considered temporary and therefore subject to sales tax.

Some items are inserted into contracts and state that a piece of equipment and certain services will be compensated on a cost-plus basis. If this is the case, the contractor is not entitled to a 15% markup for purchased equipment or related “materials.” An example of this is GPS equipment and related training.

See Section 1-602E - “Administrative Expenses” for markups related to Tipping fees, plant openings and other surcharges that are not directly related to the cost of the material to be used for the construction work.

Chapter 7 – Schedules, Time Extensions & Suspensions

1-700 Scheduling

This Section is intended for use on projects that employ Article 1.05.08 of the *Standard Specifications*. In accordance with Article 1.05.08, the contractor is required to submit a pre-award schedule to the Department. Within twenty (20) calendar days following award of the contract, the contractor shall develop and submit a baseline schedule. Once accepted, monthly updates are required.

If a project includes the Project Coordinator Special Provision it will govern, however, the contractor is still required to submit an empirical schedule prior to award in accordance with the [Bidding and Award Manual](#). For projects that do not include the Project Coordinator Special Provision (excluding Facility Construction), Article 1.05.08 of the *Standard Specifications* will be used throughout the duration of the project. The procedures outlined below should be used as a basis for review at the various stages of design and construction.

Although this Section was drafted specifically for the administration of *Standard Specifications* Article 1.05.08, the list of major elements and checklists referenced in this Section may be used for review of proposed baseline schedules for any project.

1-700A Schedule Reviews During Design Phase

The information provided below relates to schedule review procedures. For overall plan review guidance refer to the Design/Constructability Plan Review Guidelines. This can be found at: <http://www.ct.gov/dot/lib/dot/documents/dconstruction/qa/finalplanreviewdocument.pdf>.

1. 60 % Plan Review:

The staff assigned to perform the 60% plan review should compare the list of major elements, provided in Article 1.05.08 of the *Standard Specifications*, to the information provided with the plan review package. The list of major elements should be at least as detailed as the lists in the specification and show that the designer understands the work necessary to complete the project. If the Designer has not provided adequate detail or has not provided a list of major elements with the review package, the reviewer should comment accordingly.

2. 90% Plan Review:

The District staff assigned to perform the 90% plan review should compare the information provided in Article 1.05.08 of the *Standard Specifications* to the list of major elements provided with the plan review package as well as the proposed Microsoft calendar day chart and the proposed calendar days provided by the Designer during the P.E. phase. The list of major elements should be at least as detailed as the list of major elements in the specification. The calendar day chart should show that the Designer understands the sequence of construction and the calendar days should appear to be a reasonable estimate of the time required to complete the project, including individual activity durations. The reviewer should keep in mind the feasibility or constructability of the project as outlined in the designer's proposed construction schedule. Any permit restrictions should be shown with only appropriate activities occurring during that time, as well as, any other time constraints. The Final Microsoft calendar day chart shall be signed off by the District Construction Transportation Supervising Engineer (TSE) overseeing the design review, or their designee, prior to the Final Design Plan (FDP) Submission

1-700B Pre-Award Submittal

The Bidding and Award Manual includes requirements for the pre-award submission of a comprehensive bar chart schedule by the Contractor. This pre-award bar chart should generally meet the requirements of Article 1.05.08 of the *Standard Specifications*, in that it should identify the major parts of the work (including utility relocations) and

the critical path. The level of detail should be appropriate for the project. It should be clear to the reviewer that the Low Bidder understands the project requirements. As a reference the reviewer should compare the list of major elements listed in Article 1.05.08 of the *Standard Specifications* and the designer-developed schedule to the Low Bidder's pre-award schedule. This information is available in ProjectWise. The goal is that the pre-award schedule should be consistent with and/or the basis for the baseline schedule after award.

The procedures outlined below should guide the District staff through the pre-award activities:

Within two to three weeks after the bid opening the District should receive the pre-award schedule submission from the Office of Contracts. If the schedule is not received by this time, District staff should contact the Office of Contracts.

Upon receipt of the schedule from the Office of Contracts, the District will review it in accordance with Article 1.05.08 of the Contract as the basis and return their comments to the Office of Contracts as soon as possible prior to award.

If the District feels there are significant issues with the pre-award schedule that reflect a lack of understanding of the work required to complete the project, the District should request a pre-award meeting to discuss the schedule through the Office of Contracts.

If the District and the Office of Contracts agree that a pre-award meeting is warranted the Office of Contracts should arrange a meeting with the Low Bidder and District to discuss the issue(s) prior to the award of the contract.

1-700C Post Award Submittals - Baseline and Progress Schedules

The post award procedures related to project schedules depends upon the scheduling specification that applies to the project. If the Project Coordinator Special Provision is in the Contract, it will supersede Article 1.05.08 of the *Standard Specifications*.

The Office of Construction (OOC), Claims and Litigation Unit, will provide assistance to the District personnel, if requested, for the review of proposed schedules and procedural questions related to the scheduling requirement. Once the project has been awarded, the District is responsible to review and approve the baseline schedule, as well as review and comment on all monthly updates. The comments should address any issues identified in the schedule and require that they be addressed. The Department should not "approve" monthly updates. If no issues are noted then the correspondence should indicate that. If necessary, the District may direct the preparation of recovery schedules in accordance with the scheduling specification.

If the Contractor does not comply with the requirements of the scheduling specification, the project staff should withhold payment in accordance with the appropriate specification until such time as an acceptable schedule has been provided.

1-701 Documentation of Delays and Impacts

The *Standard Specifications* allow the Contractor to, submit written requests for, "extension of Contract time if the time necessary for completion of the Project has been increased due to extra or added work or delays resulting from unforeseeable causes beyond the control and without the fault or negligence of the Contractor, except for weather or seasonal conditions (unless extraordinary and catastrophic)."

The inspector should document all potential delays on their SiteManager DWRs or Diaries. Proper documentation is essential for evaluating time extension requests.

The minimum information that should be reported on the DWRs/Diaries include:

- Date the delay first arose and the date the delay ceased to exist. The Inspector should use their best judgment to estimate these dates and document accordingly.
- Identifying if the winter days count becomes very important depending on the type of delay:
 1. If the delay is excusable, where the Department will be approving an extension of contract time and winter shutdown is part of the contract, winter time is *not* counted.
 2. If the delay is non-excusable, where liquidated damages may apply or winter shutdown is not part of the contract time, the winter time *is* counted and liquidated damages applied.
 3. All DWRs through the winter period should be reviewed for accuracy.
- The apparent cause and a description of the delay along with the apparent effect of delay on work items. This is for direct cost tracking and future analysis. The exact impacts may not be able to be determined until later.
- Operations in progress during the delay.
- List all labor and all equipment, in detail. Note which was idle and which was active each day of delay. It is essential to document the equipment accurately as Idle or Active and the purpose the equipment has on the project. Photographic documentation should also be made.
- If this information proves to be voluminous to incorporate in the electronic DWR text fields, the inspector may attach a write up or create a written project folder or add it to the Volume V as detailed in Subsection 1-307 and reference the information from the Site Manager DWR.

1-702 Time Extensions Procedures

The procedures outlined in this Section should be used for evaluating, approving, and issuing time extensions.

1-702A Time Extension Authority

The authority for granting time extensions is found in Article 1.08.08 of the *Standard Specifications* “Extension of Time.” The Article covers acceptable reasons for a time extension “for completion of the work due to extra or added work or delays resulting from unforeseeable causes beyond the control and without the fault or negligence of the Contractor.”

If the Assistant District Engineer (ADE) or District Engineer (DE) is uncertain as to whether the reasons provided by a Contractor to support a request for an extension of time are acceptable under Article 1.08.08, they should discuss the issue with the Construction Administrator or Construction Division Chief.

1-702B Time Extension Requests

Time extensions **must** be requested by the Contractor in a timely manner. Contract provisions in Article 1.08.08 require notice within 60 calendar days from the event that is the basis of the request or from the first effect of such an event on the project. **The Contractor is responsible for providing the necessary documentation to support the reasonableness of the additional time requested.** This will include a Critical Path Method Schedule Analysis and accompanying narrative that includes the specific dates and number of days for which the extension is sought, the basis or bases for the extension, and the schedule analysis illustrated in a graphic representation of the schedule impacts such as a bar chart or other type of graphical schedule and supporting documentation, including Department directives, supplier/subcontractor correspondence, etc.

The Project Engineer (PE) should provide written acknowledgement of each Contractor’s time extension request in a timely manner. If the information is determined to be incomplete, or fails to meet the requirements of the contract,

the PE should respond accordingly and state that the time extension cannot be granted unless the Contractor complies with the requirements. A sample letter from the PE for a time extension response may be found in the Approved Forms folder in ProjectWise.

A separate file should be created to store copies of the Contractor's accepted baseline schedule, monthly updates, as-built schedule, original Engineer's schedule, and other related correspondence as it pertains to any request for additional contract time.

1-702C Time Extension Analysis

The District staff should prepare a report documenting the recommendation to the ADE for each time extension request. The following topics should be included in the report:

- A description of the request.
- An evaluation of the request based on the field records.
- Each specific delay needs to be identified and explained in detail including the periods of the delay on the critical path of the project as well as explaining any time determined to be concurrent with another delay on the project.
- An evaluation of the Contractor's Critical Path Schedule Analysis which should have been submitted as part of requirements of 1.08.08 and at a minimum included:
 1. The manner in which the Contractor planned to construct the Project, in terms of activities, logical interrelationships of activities, work sequences, activity durations, and calendars.
 2. The actual duration and sequences of the activities, based on what actually occurred on the Project.
 3. The variances between the planned and actual performance of the work, listed in a chronological and cumulative manner, summing to the net total delay on the Project at the time of the request.
 - a. The causes of the variances between the planned and actual performance of the work, specifically allocating legal responsibility for each to either the Department or the Contractor.
 - b. The effects of the variances in work sequences, activity durations, manpower, and resources on the incurred costs of the affected party or parties.
 4. An identification analysis of the causes of any concurrent delays on the Project.
 5. Statements as to whether the time extension days sought are compensable or non-compensable, along with a specific statement of any compensation requested in connection with the time extension. Any request for a time extension that does not include a corresponding request for compensation will be assumed to be a request for a non-compensable time extension.
 6. All associated analysis documents, worksheets, schedules and contemporaneous documents support the the Critical Path Method Schedule Delay Analysis.
- A conclusion with the standard reference for time extension reasons. Refer to Subsection 1-702D, "Standard Reference for Time Extension Reasons," for specific guidance.
- A recommendation.
- A comparison of the Contractor's anticipated and actual schedules and the effect of each cause of delay and how it impacted the critical path schedule for the Project.

When performing the time extension analysis, the reviewer should consider the following:

- Did the condition causing the delay exist at the time bids were received?
- Was the condition discussed at the Preconstruction Meeting?

- Do you believe the Contractor might have reasonably expected to have full knowledge of the condition(s) causing the delay?
- Was the delay beyond the Contractor's control?
- Could the delay be attributed to the Contractor's means and methods of operation?
- Sequencing - Was the Contractor directed or asked to sequence the work to mitigate the delay?
 1. Did the Contractor fail to or refuse to re-sequence the work to mitigate delay?
 2. Did the Contractor have other areas in which to operate?
 3. Was the Contractor advised to work in other areas, to use idled workers and equipment?
 4. What other operations were in progress during the delay?
 5. How did the delay impact the project's critical path?
- Was the Contractor responsible for any portion of the delay which could have been concurrent with the requested delay period?

The report should be forwarded to the ADE by memorandum for approval/disapproval. A template approval memo is available in the Approved Forms folder in ProjectWise.

[Time Extension Memo](#)

If a time extension could expose the Department to liability for costs incurred during or resulting from delay of project work, it must be discussed with the OOC – Claims and Litigation Section, Transportation Principal Engineer (TPE) level before approval.

It is important to process time extensions as they occur or within a reasonable time frame after occurrence.

1-702D Standard Reference for Time Extension Reasons

The time extension reasons should be included in the conclusion of the analysis.

- (1) **Natural Catastrophe:** Work delayed as a result of an extraordinary event that could not have been foreseen nor prepared for at the time of bid, such as extreme weather, hurricanes, earthquakes, fires, etc.
- (2) **Changed Conditions:** Delays caused by differing site conditions (subsurface or latent field conditions), delays resulting from unexpected hazardous material that results in special handling that could not have been anticipated prior to construction.
- (3) **Acts of Government:** Requests made by a municipality, state, or federal government during construction that was not included in the original contract.
- (4) **Design Change:** A design-initiated construction order or design change order for work not included in the contract and which is not identified in the other Time Extension categories.
- (5) **Extra Work Order:** Time allowed for additional work made necessary by the Engineer's changes to the Contract plans or specifications, which was not addressed in the original contract work, with the exception of a design change order (in #4 identified above).
- (6) **Permits:** Construction delays due to time required to modify or issue a permit, such as Army Corps, DEEP, United States Coast Guard, Local Conservation Commission, etc.
- (7) **ROW:** Delays caused by actions of the Office of Rights of Way to acquire access rights to property deemed necessary for contract work.
- (8) **Temperature Restriction:** Delays due to restriction for temperature sensitive materials, including winter shutdowns, not caused by the Contractor's own scheduling of work.
- (9) **Third Party:** Any delay caused by the action of a third party not more specifically defined in any other category, such as an owner of adjacent property, strikes, suppliers, etc.
- (10) **Utility – Railroad Delay:** Construction delayed waiting for utility companies to move their facilities or delays caused by railroad companies

1-702E Federal Agency Approval

Before approving a time extension for Projects of Division Interest (PODI) (formerly categorized as full federal oversight projects), the ADE must forward the time extension request and analysis to the FHWA Division Engineering Team Leader for approval. A sample letter to FHWA requesting concurrence and participation in a time extension is available in the Approved Forms folder in ProjectWise.

[FHWA Time Ext Concurrence](#)

The request for concurrence should briefly explain the reasons for the request. Upon written concurrence from the FHWA, the Assistant District Engineer may act on the time extension recommendation.

1-702F Assistant District Engineer Approval/Disapproval

Prior to approving a time extension, the ADE should:

- Ensure that the contractor, as well as the District, have provided the required documentation and that documentation adequately supports the recommendation;
- Discuss and gain the concurrence of the TPE of OOC - Claims, if the time extension exposes the Department to potential liability for delay-related costs.
- Ensure that if a Waiver of Claim or Release is associated with the time extension that the TPE of Claims has approved it.

Upon approval or disapproval of a time extension request, a copy of the recommendation package, including all substantiating documentation, must be forwarded to the OOC.

If the ADE approves a time extension, the time must be incorporated into the contract via Construction Order.

1-703 Temporary Suspensions and Resumptions

The District Engineer has the authority to suspend the work wholly or in part for such period or periods as necessary, in the best interests of the State or in the interests of public necessity, convenience or safety. Before a suspension is issued, it must be authorized by the Construction Administrator or Construction Division Chief.

If a suspension is ordered by the District Engineer, the District Engineer or Assistant District Engineer must notify the Contractor in writing of the effective date of such suspension and the anticipated resumption date (if known). Also, for Department notifications a Contract Status Report (CON-100) must be completed within seven (7) days of the suspension date and within seven (7) days of the resumption date. Refer to Section 1-205, "Notification of Contract Status," for specific guidance.

Notification of resumption following a suspension is handled in the same manner as the Notice to Proceed. When establishing the resumption date, remember to take into consideration the time required for the Contractor to remobilize their workforce.

Suspensions should not be ordered for a time period excluded from the Contract. For example, many highway and bridge construction projects contain a winter shutdown period, from December 1 through March 31, when calendar days are not charged.

Chapter 8 – Construction Orders***1-800 General***

Construction Orders (COs) are issued to incorporate changes to the Contract. Initiate COs to make increases and/or decreases in quantities of contract items, add extra work essential for the satisfactory completion of the project, increase or decrease the Contract time, add or modify contract plan sheets, alter the sequence or character of the work, or incorporate any other contract revision.

Executed COs become a part of the Contract and are enforced as though they were part of the original contract. Therefore, it is essential that the CO explicitly describe the change including;

- The character and scope of the change.
- Where and within which limits the change applies.
- The method of compensation.
- Changes in contract time.

Also, there are many important reviews, analysis, determinations, and approvals required before initiating and during processing of the CO. These need to be performed and documented in a timely manner to avoid misunderstandings, delays in payment, or findings of federal ineligibility.

1-801 Review of Proposed Changes

Changes and extra work should be held to the minimum and limited almost exclusively to revisions and additions necessitated by conditions that have changed or could not have been reasonably anticipated before the project was bid. When the Project Engineer (PE) reviews the proposed change, the following should be considered:

- Is the change in the public interest?
- Is the change within the project limits and within the original scope?
- Does the change affect the critical path of the schedule and is a time adjustment warranted? (Increase or decrease in contract time).
- Does it involve a potential design error or omission?
- Does the change provide an equal or better material than originally planned?
- Does the change provide a better method of construction than originally planned?
- Does the Contractor benefit from the change, and if so, is there a corresponding benefit to the project or is a Credit to the State warranted?

Other considerations:

- Will the change require a Design initiated CO?
- Will the change require review and approval by the Office of Construction (OOC)?
- Are there enough funds in the project for the change?
- Will the change or CO require a notification to Office of Finance – Capital Services Division?
- Are federal funds involved and if so, will modification to the Federal Aid Agreement be required?
- What are the testing requirements for new items / materials?

1-801A Proposed Changes that Require Additional Approvals

Certain changes require additional levels of approval prior to being incorporated into a CO. Refer to the relevant chapters in the Construction Manual for specific requirements. The following are some typical examples:

All changes to an existing contract item's Method of Measurement/Basis of Payment must have prior approval from the OOC Division Chief or Construction Administrator. A copy of the email or other written confirmation approving Method of Measurement/Basis of Payment changes is to be kept in the project records.

COs that involve price adjustments, differing site conditions, or claim settlements cannot be initiated until the Transportation Supervising Engineer (TSE) obtains the required approvals for those cases as shown below:

- For all price adjustments that involve Articles 1.04.02 (Changes in Quantities of Pay Items, Including Elimination of Such Items), 1.04.03 (Changes in Quantities and Significant Changes in the Character of Work), and 1.04.04 (Differing Site Conditions), the TSE must obtain concurrence from the Assistant District Engineer (ADE).
- For price adjustments that involve Article 1.04.03 or 1.04.04 and the total adjustment is less than \$250,000 the ADE must also obtain concurrence from the District Engineer (DE);
- For price adjustments that involve Article 1.04.03 or 1.04.04, and the total adjustment is greater than \$250,000 the DE must obtain concurrence via email or other written confirmation from the Construction Administrator or the Construction Division Chief.
- For claim-related payments, the ADE must obtain prior concurrence from the Transportation Principal Engineer (TPE) – Claims and Litigation Section.

1-801B Review of Changes for Federal Eligibility

When reviewing changes to a contract with federal funding the project staff must consider:

- Is the change eligible for federal participation?
- Is the change included in the Project's National Environmental Policy Act (NEPA) document?

When reviewing the proposed changes on projects with FHWA funds and the subsequent eligibility of those funds, the project staff should consider if the work is within the project limits and if the work is required to complete the Contract within its original scope. Generally, extra work that is not necessary to complete the original proposed improvements is not eligible for federal participation. The flowchart below (Figure 1-8.1) is an internal FHWA CO eligibility guidance document that an inspector can use to perform an early determination of eligibility. If the eligibility is not evident, the PE should contact FHWA to obtain a final eligibility determination prior to the development and recommendation of the CO.

All federal projects are covered by a NEPA document that defines the general project improvements, project limits and the anticipated impacts from those improvements. If a proposed change to the Contract changes the proposed improvements or project limits, then there may be additional restrictions and Engineering must be consulted to determine if the proposed change is consistent with the approved NEPA document, if the NEPA document must be re-evaluated, or if the improvements are ineligible for federal participation.

NOTE: If the determination of eligibility cannot easily be made, the PE must elevate the discussion and, if warranted, the final determination of the use of federal funds should be discussed between Construction and Engineering management, the Office of Finance – Capital Services Division, and the FHWA.

Figure 1-8.1: FHWA CO Eligibility Guidance Document

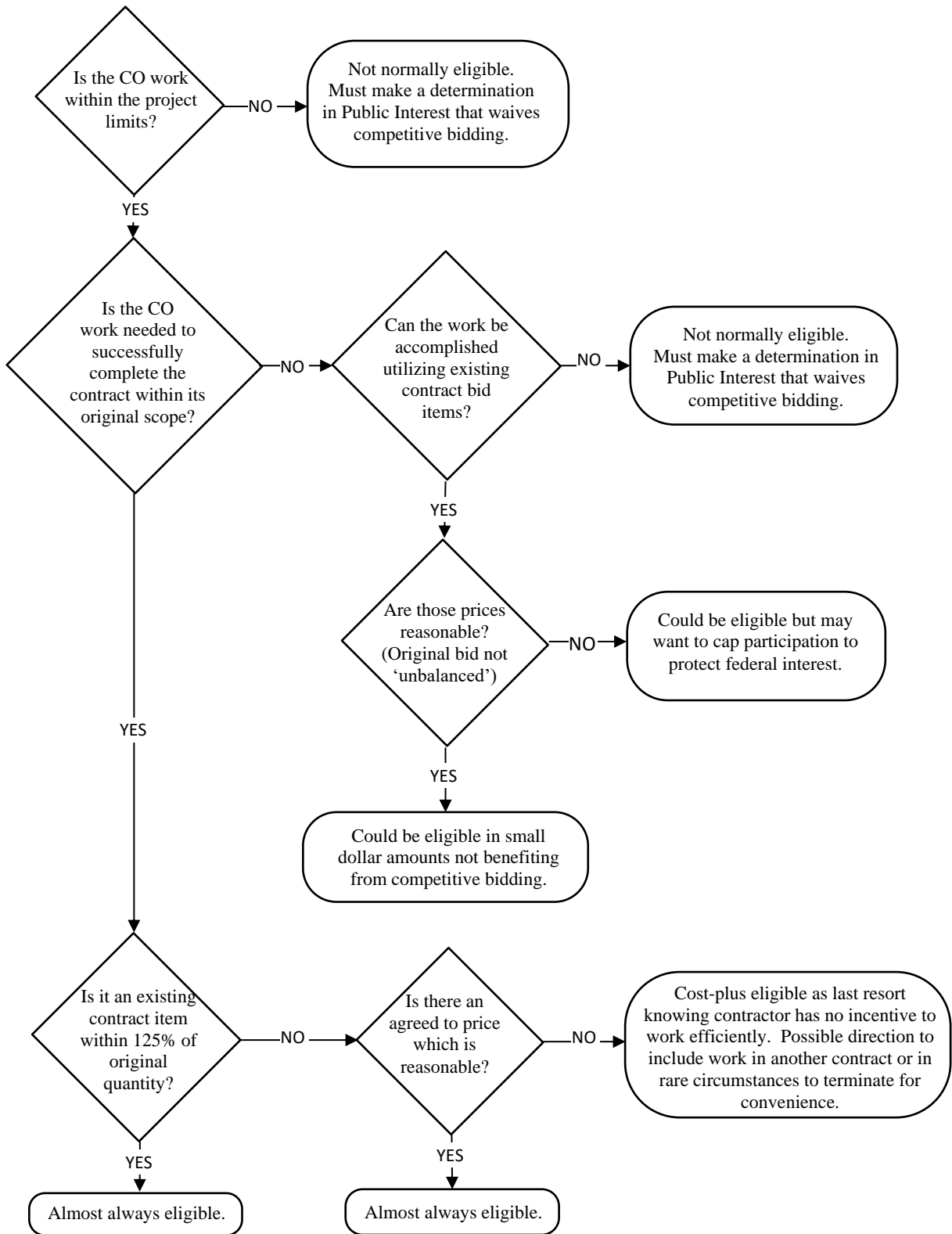

1-802 General Processing Guidelines

COs are processed according to the following guidelines:

- The PE and the Inspector must make regular checks of the project records to identify any need for a CO.
- COs that have been initiated should be sent to the Contractor for their signature within 30 days. The exception to this may be if the Inspector is waiting for additional documentation from the Contractor.
- Ideally, COs for new items and cost-plus work should be sent to the Contractor before work commences on those items. COs with new items should be sent to the Contractor within 15 days following the date of the price approval letter or the direction to go cost-plus.
- Draft COs for emergency work or work of a critical nature must be submitted to the District within 5 working days after the start of the extra or additional work. If actual costs are not known, they should be estimated and processed as “estimated cost-plus.”
- Available funding for the CO work must be evaluated as soon as the cost is estimated. When evaluating funding, consideration should be given for changes in costs that may occur, such as utility work, consultant work, design support and incidentals.
- Project modifications must be initiated in a timely manner. The further along the project is, the more critical this becomes.
- Any COs not returned within 15 days or returned unsigned by the Contractor must be noted as such and processed unsigned.
- If the Contractor returns the CO with objections, the District should respond in writing to the Contractor with the action taken.

1-803 CO Development

The Inspector is responsible for the preparation and content of COs. For detailed explanation on how to create a CO in SiteManager, refer to Appendix A, SiteManager User Guide.

The District is allowed to make changes to the Contract within the original scope of the project and within the original project limits. All other changes should be initiated by Engineering due to the necessary checks and balances related to prior commitments by the Department. (Refer to Section 1-805).

The process to initiate a CO should be started as soon as the potential need for a change is identified. The TSE must review and approve any requested change prior to work being performed, except for routine quantity changes.

Revised quantity determinations are to be made as the work progresses, and final quantity revisions are to be included on intermediate COs as items are completed. Updating quantities on intermediate COs reduces the time required to prepare the final CO, which enables the Department to keep better track of the probable project cost, and avoids unnecessary revisions to the performance bond, which may increase costs. (Refer to Chapter 19).

Revisions to contract time are to be processed on intermediate COs whenever a Contractor’s request for an extension of contract time is approved or when the Department has modified the Contract work requiring a change in contract time. A full explanation justifying the revisions in contract time must be attached to the CO. (Refer to Section 1-702, “Time Extension Procedures.”)

COs that involve Value Engineering Change Proposals (VECPs), as described in Chapter 1-23, will follow the guidance in Article 1.09.02 to reflect the changes in unit bid item quantities or new agreed price items,

as appropriate. A Value Engineering Incentive item (Lump Sum) will be created representing 50% of the total savings as a result of the implementation of the approved VECP. Payments will be made to the Contractor under this item as outlined in Chapter 23 Section 1-2303, "Value Engineering."

Each (VECP) must be incorporated into the Contract in a separate CO and will have the VECP Request Form with approval signatures and backup documentation package in the Addendum. (Refer to Chapter 23 – Value Engineering Change Proposals.)

1-804 CO Approval Requirements

When the total value of a CO exceeds \$250,000, the Office of Finance – Capital Services Division, OOC Liaison Engineer, and the DE should be notified in advance of the forthcoming change.

A CO which incorporates major changes into the Contract may require review and approval by the OOC.

1-804A Approval Requirements by the OOC

COs must be discussed with the OOC when (1) COs are valued in excess of 25% of the original contract value or \$500,000 or (2) may cause a delay to the project of more than 6 months. Background documentation shall be forwarded to the Liaison Engineer as soon as the information becomes available. The District should not proceed with the work until authorized by the Construction Administrator or Construction Division Chief via email or other written confirmation. The combined value of all related COs shall be used to determine if approval by the OOC is required.

1-804B Requirements by the Federal Highway Administration (FHWA)

In addition to the normal internal Department approval requirements, the Inspector shall be guided by the current version of the CTDOT/FHWA Stewardship & Oversight Implementation Manual regarding the roles and responsibilities related to the approval of COs by the FHWA.

For all federal-aid funded projects, the PE is responsible for making the eligibility determination and processing of COs. If the eligibility of a proposed change is in question, the PE should contact FHWA to obtain a final eligibility determination.

1-805 Design Initiated COs (DICO)

COs are required for all design initiated changes.

The following guidelines have been established for DICO:

- For COs less than \$25,000, a CO initiator from Design will not be required. Emails or meeting minutes will be sufficient supporting documentation for the Inspector to prepare the CO.
- For COs greater than \$25,000, a DICO memorandum should be required from the initiating unit which will include details for the change and an analysis of how the change will affect the project. (Refer to Section 1-805A.)
- For complex changes involving unforeseen conditions, changes in scope, or a revision to the Contract specifications, regardless of the cost, a DICO memorandum will be required.

1-805A Analysis of Design Initiated COs (DICO)

The construction project staff should perform an analysis of the designer's estimate of the work provided in the DICO to determine if the estimated costs and time impacts are reasonable and the designer has accounted for all effects that the work may have on the project.

The following guidelines should be followed in the analysis:

- Assess the effect the proposed revision has on the Contract lump sum items such as Mobilization, Maintenance and Protection of Traffic, and Construction Staking. This should be included in the estimated cost when applicable.
- If contract items do not exist or if the character of the work differs from the existing contract, the Inspector in conjunction with the PE should estimate the cost of the extra work, based on the weighted unit prices for the current time period or an independent evaluation of the work.
- Consider and review impacts (direct and indirect) caused by the DICO to other construction activities on the project.
- Analyze and review the effect the DICO has on the project schedule.
- Review if applicable specifications are noted or provided for the work in the DICO.
- If applicable, determine if Engineering has obtained concurrence from FHWA that the work is eligible for federal funding.

Review Project budget and assess if there is sufficient funding for the DICO or that adequate additional funding has been requested. In assessment, make sure to include any increased cost that may be supplementary to the DICO, such as inspection and utility work.

If the Engineering DICO cost estimate or the impacts to the Contract time appear to be unrealistically low, a discussion with the Design Project Manager should be held to better understand the scope of work. If the costs or time impacts are significantly different, the previous decision to include the work within the current contract may not be valid. A higher level discussion with Engineering and Construction management may be necessary.

1-806 CO Addendum

Addendums to the CO, which are kept in the project files, should be clear and concise, including detailed information so that persons with no knowledge of the project will have a clear understanding of:

- What the change is
- Who initiated the change
- Who approved the change
- Where is the specific location of the change
- Why is the change needed
- When the change was initiated

Generally, the CO addendum should reference the following supporting documentation:

- The District's letter to the Contractor advising of additional work and requesting a price submittal for new contract items.
- The Contractor's letter proposing prices, with supporting back-up documentation.
- The District's letter to the Contractor approving prices or, if the prices cannot be substantiated, notifying the Contractor that work will be done on a cost-plus basis.
- FHWA approved "*Record of Prior Approval for Major Contract COs*" form.

The documentation and explanations provided in a CO must clearly explain the need and authority for the change and provide an analysis that people unfamiliar with the project can understand. The following guidelines should be followed when preparing a CO:

- Incorporate revised plan sheets to document dimensional changes or a change in the plans or typical sections (with the exception of minor revisions in the location of culverts, manholes and catch basins).
- Overruns/Underruns (no design change): Provide a detailed explanation whenever both of the following conditions are met: 1) the cumulative quantity change of an item varies by 25% or more from the original estimate, and 2) the value of the quantity change is more than \$25,000. The reason why the quantity differs from the design estimate should be explained in detail whenever possible. Avoid simply stating that Design overestimated or underestimated the item. If the designer provided insufficient detail to determine why there is an overrun or underrun, indicate so. Do not include quantity changes caused by design revisions in a routine overrun/underrun percentage.
- For federal-aid projects, when ineligible work is involved, apply the item change to the appropriate ineligible section (line item). NOTE: Unused construction materials transferred to State Stores are always ineligible.
- When an item has more than one project section, the quantity change must be applied to the correct section (line item) in the CO.
- Reference the letter directing the work be done on a cost-plus basis. This letter should include a ceiling price (initial estimate for anticipated costs) that the Contractor is not to exceed except at its own risk. The ceiling price must be estimated using reasonable assumptions documented on a calculation sheet that is signed and dated.
- Upon completion of a cost-plus operation, a CO must be processed to adjust the item total value to the final cost of the work. The detailed explanations for this CO should list any previous adjustments made, and refer to the original and any supplemental COs.
- Documentation used to support the CO must be referenced and identified, such as memorandum requesting design revision, price approval letter establishing price for new items, etc.
- Supplemental COs that adjust revisions made on previous COs must refer to those COs.

1-807 Standard Paragraph Explanations - Classification of Line Item Changes

The standard paragraph explanations focus on why the change occurred, not who initiated the change or how big the change is. Also, the explanations below are organized so that the Inspector can quickly determine which explanation applies and that the explanations are applied uniformly throughout the Districts.

To apply an explanation to a change, the Inspector must first determine the reason for the change. The Inspector shall begin with the first explanation (1-U) and proceed down the list until the appropriate explanation is determined.

- 1-U Unforeseen Condition – Additional work necessitated by encountering reasonably unforeseeable conditions which differ materially from those indicated in the Contract or unusual conditions differing from those normally encountered. Items applying to this explanation are defined by Article 1.04.04 Differing Site Conditions of the *Standard Specifications*. Examples: discovered underground storage tank, unanticipated contaminated materials, concealed decay, unanticipated rock or groundwater.

- 2-S Change in Scope – Changes from the original intent or purpose of the project, extension of projects limits (such as additional signalized intersection, limits more than 100' beyond original, etc.), elimination of contract work, and work not normally associated with the type of work originally bid.
- 3-C Contract Revision – Changes in the original design initiated by Design or Construction which fall within the original scope of the project and do not alter the basic character of the project. This also includes revised specifications. Examples: revisions to pavement markings, revisions to base materials, revisions to stage construction, revisions to signalized intersection.
- 4-Q Quantity Adjustments – Minor increases or decreases in original quantities not attributable to any of the above explanations. (Increase or decrease of less than 25% from the original estimate, or the accumulated value of the quantity change is less than \$25,000.)
- 5-O Other Adjustments – Revisions to the Contract or plans to correct foreseeable changes which reasonably could have been expected such as work shown on the plans for which no pay item was provided, no rock in trench item where rock outcrops are plainly visible, revisions to comply with environmental permit requirements or ROW agreements, incorrect original computations, and elevation bust resulting in extra work to correct.
- This explanation also includes (VECP).
- 6-T Time Extension – Adjustments of the allowable contract time for any portion of the work.

NOTE:

- Each item in a CO must have one standard explanation applied to the specific item (line item) to classify the change. Same items of work being changed in different locations or for different reasons (and subsequently would have a different explanations) must be incorporated on separate COs.
- With the exception of minor overruns and underruns of existing contract items, additional explanations must be provided to describe the change in detail.
- For further explanation on how to create explanations for COs in SiteManager, refer to Appendix A, SiteManager User Guide.

1-808 Authorization Levels to Process COs

The TSE will authorize the processing of COs for:

- Routine quantity revisions.
- Extra and additional work that has received prior approval by the Department.
- Time extensions.
- Any other item not reserved for other authorities.

The ADE must authorize the processing of COs when:

- The CO value exceeds \$150,000.
- The CO adjusts the price of an item under Article 1.04.02, 1.04.03, or 1.04.04.
- The CO addresses a potential claim issue.
- The CO contains an item change that involves a potential design error or material change.

District Management (DE or ADE) shall obtain the prior concurrence via email or memo from the Construction Division Chief or Construction Administrator when:

- A CO is valued in excess of 25% of the original contract value.
- The aggregate value of all CO items related to a specific issue exceeds \$500,000.
- The CO contains price adjustments greater than \$250,000 in accordance with Articles 1.04.03 and 1.04.04.
- The changes in the CO may cause a delay to the project of more than 6 months.

1-809 District Review and Processing Procedure

Each District will implement a review process that enables the majority of the COs to be processed as noted above in Section 1-802.

A routing slip is to be used to document the review process, including the approval authority. Refer to the Approved Forms folder for the current routing slip.

1-809A Review by Project Engineer

The PE Engineer has the primary review responsibility. They will:

- Review the CO for scope, eligibility, completeness, and accuracy. Check for appropriate specification references and accurate descriptions of any changed conditions.
- Review the explanations, including referenced documents to ensure an adequate basis is established for the changes contemplated and that all relevant attachments are provided.
- Return the CO to the Inspector if major revisions are required.
- Sign, date and forward package to the TSE.

1-809B Review by the TSE

The TSE ensures that the CO complies with current Department procedures. They will:

- Review the CO and attachments for accuracy.
- Review the CO items to ensure federal eligibility was determined.
- Determine the appropriate level for approval of the draft CO in accordance with the guidelines listed above.
- Meet with the ADE, as appropriate, to obtain approval of the draft CO. When new items are being added, coordinate with the DMT to ensure proper testing requirements are established and made known to inspection staff.
- Return the CO to the PE if revisions are required.
- Sign and date the routing slip and return to District staff for initial processing.

1-809C Review and Initial Processing by the District

The District Office Staff performs the following when processing a CO:

- Check funding availability.
- Review general format.
- Ensure required corrections are made by the Inspector or PE.
- Prepare the package with a cover letter to the Contractor.
- Return the completed package to the PE for signature.
- Notify the Office of Finance and Administration – Capital Services Division each time the cumulative total of COs increase or decrease the Contract value by \$250,000.

1-809D Processing by Project Engineer

The PE reviews the completed package to ensure comments have been incorporated, signs all copies and sends the CO to the Contractor for signature.

1-809E Processing by the TSE

The TSE has the primary responsibility for approval of COs. The District Office receives the CO from the Contractor and sends it directly to the TSE for approval.

If the Contractor fails to return a CO within 15 days, the District Office sends the unsigned CO to the TSE for approval.

The TSE signs the CO and forwards it to the District Staff for further processing.

When a Contractor returns a CO unsigned, and the Contractor has stated their objection, preferably in writing (a copy of this document is included with the CO). The stated objections are investigated to the satisfaction of the TSE. The TSE will consult with the ADE as appropriate. If the objections are determined to be invalid, the CO is processed unsigned and the Contractor is notified of the action. If the objections are determined to be valid, the CO is revised or a subsequent CO is processed with the appropriate corrections.

1-809F Final Processing by District

The District Office Staff does the following to complete the final processing:

- Add the explanations (addendums) and attachments to the CO copies, as required.
- Send an approved copy to the Contractor
- File the approved copies.

1-809G Distribution

Once a CO is approved, copies are distributed as noted in Figure 1-8.2 Distribution of CO Copies.

1-810 Final COs

The final CO typically balances item quantities. This should be completed within 45 days of the Final Inspection. It should be identified as the final CO whenever possible; however, it is not necessary if previous COs were processed to balance all items, and have made all required time and contract revisions. If the final CO has been accepted and quantity changes or new items are required for any reason, another CO is initiated. A copy of the final (last) CO is included in the Final Package.

Occasionally, the final CO is delayed because there are disagreements on quantities, missing documentation, or disagreement on the interpretation of the Specifications, Special Provisions or plans. The CO shall include the necessary notes that contributed to the overall delay in the processing of the final CO and estimate. The ADE should be advised promptly of any problems that may affect the expeditious processing of the necessary papers.

Chapter 9 - Contract Payments

1-901 Estimated Progress Payments

Monthly or semi-monthly progress payments are made to the Contractor in accordance with the *Standard Specifications* Article 1.09.06 which includes payment for work completed through the ending date of the estimate period. This chapter explains the estimate and progress payment process. The procedure for processing an estimated progress payment in SiteManager is explained in the SiteManager User Guide. The final estimate preparation is discussed in Volume 1, Chapter 10 - “Contract Completion” of this Manual.

Include all contract item work that has been completed satisfactorily in accordance with the Contract in monthly and semi-monthly estimated progress payments. Do not pay for material placed or installed for which the required evidence of acceptability (Certified Test Reports, Materials Certificates or acceptance tests) has not been obtained, unless approval is given by the Transportation Supervising Engineer (TSE).

1-902 Estimate Period

The period covered by the first progress payment begins with the Notice to Proceed date and ends on the first typical estimate ending date established by the District, normally the first or last day of the month. If the estimated payment does not exceed \$2,500.00, the District may opt to not process the estimate for the given period. All succeeding payments should be run on a recurring frequency, either monthly or semi-monthly.

1-903 Estimate Preparation and Review

The Chief Inspector (CI) is responsible for the preparation of the progress payment. Before an estimated progress payment is generated, the CI Inspector must verify that all Daily Work Reports (DWR), including those for sub-inspectors, are entered, reviewed and authorized for the period.

Once all the DWR s are accepted, the CI will generate an estimated payment and address any discrepancies, and make appropriate adjustments. After the discrepancies have been addressed and adjustments made, the CI should review the estimate quantities with the Contractor. If any issues can't be addressed, the Project Engineer (PE) will be notified and provided with details. After reviewing the estimated payment with the Contractor, the estimate should be forwarded to the PE for review and approval.

The PE should review each estimate with the CI or Resident Engineer (RI). Among the items that are to be discussed are:

- Quantity over-runs
- Material/Testing deficiencies
- Contract Adjustments
- Defective workmanship
- Work in progress
- Estimated quantities and payments (refer to Sections 1-302C, 1-305 and 1-912)
- Contractor disputed items

Items of concern noted in the discussion between the PE and the CI should be elevated to the TSE.

The (TSE) must be satisfied that the proper procedures have been followed prior to approving. Upon review and approval of the estimated payment by the TSE, it will be forwarded to the Assistant District Engineer (ADE) for review and approval.

1-904 Construction Budget

The CI or PE is required to monitor the available construction funds after the processing of each estimated payment in collaboration with either District support staff or appropriate Fiscal staff in Newington.

If additional funding is anticipated, the PE must coordinate any required fiscal modification(s) as necessary with the assigned Fiscal Officer.

1-905 Retainage and Securities

Contracts advertised after January 1, 2013 typically do not allow retainage to be held. For any questions involving retainage and securities contact the OOC.

1-906 Extra or Additional Work

Payments for extra or additional work added via Construction Order (CO) should not be made until the CO has been executed. Payments for Contract item overruns that are not the result of a change in the Contract may be made without a Construction Order in place provided 1) there are sufficient funds available to pay for the additional work, 2) the cumulative increase for the item is not greater than 25% of the original estimated quantity, and 3) the item overrun will be incorporated by Construction Order or be contained in a draft/pending Construction Order before the next monthly and semi-monthly estimates.

1-907 Liquidated Damages, Sanctions, and Item Adjustments

This section outlines the guiding principles to be followed related to administration of Liquidated Damages, Sanctions and Item Adjustments.

If Liquidated Damages, Sanctions or Item Adjustments will be applied to an estimate, the District should notify the contractor of the impending adjustment.

Liquidated Damages:

Liquidated Damages are defined in Division I of the *Standard Specifications*. The waiving of any Division I provision, in this case liquidated damages, requires the prior approval of the Office of Construction (OOC) Division Chief. See Chapter 15 for further detail.

Liquidated damages for Contract time should be assessed when the allowable Contract time or completion date has been exceeded, except when the District has evaluated the reasons for a time extension and the draft time extension is in the process of being approved by the ADE.

In the case of a pending time extension request, the District should issue a letter(s) informing the Contractor that the request is being evaluated; however, the District reserves the right to assess liquidated damages.

Liquidated damages for lane closures must be deducted when a lane is kept closed beyond the time permitted unless the Contractor has been given advance approval to keep the lane closed for an extended period of time; or is directed to keep the lane closed for reasons not caused by the Contractor, i.e. traffic accidents, unless otherwise approved by the OOC Division Chief.

Sanctions:

Sanctions may be imposed by the Department of Labor when the Contractor fails to pay the prevailing wage. Sanctions may also be imposed in accordance with DBE or SBE special provisions.

Item Adjustments:

Item adjustments will be incorporated per the Contract item provision. Supporting documentation for item adjustments must be maintained with the subject item documentation.

1-908 Deductions

Deductions (as opposed to Liquidated Damages, Sanctions, and Item Adjustments) are those amounts held back for specific purposes such as overweight vehicles, deficient material testing, warranty period not completed, final finishing not completed. These deductions may be either temporary or permanent. The CI in conjunction with the PE must identify, initiate and control all deductions.

It is preferable to base deductions on known amounts, but, if necessary, they can be estimated.

CI must keep documentation and summary sheets in the appropriate Contract records to support all deductions.

1-909 Payment for Stored Materials

Due to the complexity of the documentation necessary for payment of stored materials this section is divided into subdivisions in an effort to outline the specific requirements depending on storage location and other conditions. The first subsection (1-909A) addresses general requirements for stored material payments. The subsections that follow (1-909B, C, D) explain special requirements for materials stored in state, out of state, raw and partially fabricated materials.

1-909A General Requirements

Article 1.09.06-B of the *Standard Specifications* provides for payment of materials, stored either on or off the project. Under the specifications, payment for stored materials is discretionary. Therefore, the State's interests must be protected and adequate protections must be in place to ensure that the State actually owns, and has rights to inspect and recover the materials.

Article 1.09.06 states that material payments shall not exceed the contract price less the actual value of delivery and installation of the materials.

Schedule of Values:

A Schedule of Values is required whenever a Contractor submits a request for payment for stored materials. The Schedule of Values shall contain all elements of work included in the contract item such as but not limited to, material costs, fabrication costs, delivery costs, any assembly costs (offsite and on site) and installation costs. *If the request is for a part or components of a larger unit, the price, description, etc. of each individual component shall be provided.* If the Contractor is unwilling to submit the Schedule of Values or does not agree with the adjustments required by the specification, the request for payment of materials stored shall not be approved.

Prior to proceeding with further evaluation of the request for stored material payment, the District shall make its own determination of the remaining costs of the item and verify that the Schedule of Values submitted by the Contractor is reasonable. Payment for stored material shall be reduced to no more than the contract price less the remaining costs of the item, even if it is less than the stated cost of the material. In the event that a reduction is required, the Contractor (Principal of the Company) must agree in writing to the reduced compensation for stored material in accordance with the specification. If the Contractor does not agree in writing to the reduced compensation, then stored material payment shall not be made. The District should generate a written approval of the Schedule of Values as well as any adjustments made.

Certificate of Title and Receipted Bill:

The *Standard Specification* states that a receipted bill or Certificate of Title is acceptable documentation for stored material payment. An acceptable receipted bill is one generated by a supplier or manufacturer which describes the material in question and documents full payment by the Contractor. The only time a receipted bill is acceptable without a Certificate of Title is when the material is fully fabricated, stored on the project site and the receipted bill states that the Contractor has made full payment for the materials.

If the conditions of the previous paragraph are not met, then a fully executed Certificate of Title is required. The Certificate of Title must be executed by all parties (Vendor, Subcontractor if applicable, and Contractor) to establish the State's ownership of the stored material. The Certificate of Title shall be kept with the project records. The [Certificate of Title](#) shall not be altered in any way (language added or deleted), except for completion of the required fields. If it is altered, it will be considered invalid and payments will not be made.

The Certificate of Title (or receipted bill) submitted by the Contractor shall provide the location, method of identification, and quantity of the material. The *identifying markings* as noted on the Certificate of Title or receipted bill *must be affixed to the materials*. Markings must be clear for easy identification while the materials are in storage.

If there are several components to the requested material, a separate page may be attached as long as the page is referenced in the description field of the Certificate of Title. The material list shall be of such detail that the Department's representative can utilize the list for the inventory required prior to payment. The cost of the material, costs of assembly or fabrication, the cost of shipping and cost of installation shall be contained in the Schedule of Values previously mentioned.

Material Identification:

A positive means of identification must be affixed to the materials and must match the notes on the Certificate of Title or receipted bill furnished by the Contractor. Markings must be clear and visible for easy identification while the materials are in storage. Heat numbers are not an acceptable marking.

Testing:

All testing requirements must be met prior to payment unless approval in writing is received from the OOC. The Division of Materials Testing (DMT) will not approve a MAT-100 for material until it is brought to the site and visually inspected by the project staff.

If the material is stored off the project site, the Assistant District Engineer (ADE) must request that the DMT review the material and provide correspondence that it meets the project specifications as of the time of the review. This is not final acceptance of the material. If the material is raw or partially fabricated the conditions of subsection 1-909D, "Raw or Partially Fabricated Materials," apply.

When the material is delivered to the project site the inspection staff must verify that the materials brought to the project site appear to be undamaged and in the same condition as when they were initially inspected.

If the material is not delivered to the project in an acceptable condition, it cannot be incorporated into the work. The inspector should first document the damage and notify the Contractor in writing that the materials are damaged and that depending upon the recommendations of the DMT the materials may be found unacceptable. They should bring the issue to the attention of their immediate supervisor and request an inspection from the DMT. No part of the apparently damaged material should be paid for.

If the material appears to be in acceptable condition (no visible damage, and generally appears to meet contract requirements) at the time the material is delivered to the site, the inspector shall process a MAT-100 for the material and forward it to the DMT for acceptance.

Inspection and Inventory:

The storage site and material must be inspected and the material inventoried to make sure the site is secure and the material inventory matches the Certificate of Title and/or receipted bill. Written approval of the storage site by the TSE shall be retained in the project records. The inspection should be performed by the CI or above. The ADE may request assistance from DMT as required.

Initial and quarterly inventories are to be performed by designated personnel depending upon the storage location. Along with the inventory, the Department representative must note if there is any visible damage to the material. Damaged materials should be brought to the attention of the DMT and shall not be paid as material stored. If the material was paid prior to identifying that it was damaged a deduction from the next payment estimate must be made.

All documentation of the inventories must be made part of the project records noting the material, quantity, location, identification and shall be recorded on the Material Stored Inventory Log. In addition to the written inventory, the Department representative should take photos of the material.

Any discrepancies between inventories shall be immediately adjusted on the next payment estimate. All stored materials that have a universal use (such as guiderail, poles, luminaires, signal equipment, pipe, etc.) shall be carefully monitored to ensure the inventories haven't changed. If the District determines that it is not feasible to perform the initial or quarterly inventories the ADE shall determine whether the request for payment of material stored can be granted.

If after review of the site it is determined that the material may be susceptible to damage or loss, the request for material stored shall not be approved.

Right of Entry and Lien Waiver:

A right of entry and a waiver of lien (against the material stored) are required any time the property where the material is stored is not owned by the Vendor or Contractor(s) named in the Certificate of Title. The right of entry will be required to grant the State access to the property and material for access and/or removal in the event that the Supplier or Contractor is unable to deliver it (due to default or other reason). The waiver of lien shall state that no lien has been placed against the material for any reason by the owner (or leaseholder) of the property. Due to the nature of the lien waiver, it will be required to be updated at the time of the quarterly inventory. If the Contractor fails to update the waiver of lien then the material payments shall be deducted from the next payment estimate. The Contractor should be informed that additional time will be required for review and approval of these documents by the DOT Legal Staff.

Unit Price Correlation:

For lump sum items or other instances when the unit of material being paid under Material Stored on site does not equal the item pay unit, a correlation between the two must be determined prior to any payments being made. The CI or RI shall discuss the proposed unit with the PE prior to making payment for material stored. Upon completion of the item for which material stored payment has been made, the project staff shall review the payments made to the item and determine if a credit must be taken for materials not used.

Documentation:

All documentation required for material stored shall be kept in the project records. The PE shall review the material stored on site documentation and initial the Material Stored Inventory Log. The PE shall verify that all necessary documentation is in the project records, payments are being properly made, all necessary inventories are performed and documented and in the case where a lien waiver is required that the lien waiver is updated quarterly.

Excess Material:

Excess stored materials should be returned to the Contractor and appropriate adjustments made to the prior payment(s), unless otherwise approved by the ADE.

Stock Items:

Generally, stock items or off-the-shelf items will not be considered for payment under Article 1.09.06, unless the material has been delivered to the job site. Exceptions should be referred to the Construction Division Chief or Construction Administrator.

1-909B Materials Stored On-Site or Off-Site within State (Except Raw or Partially Fabricated Materials)**Approval Authority:**

Approval of the request for payment of material stored within the State is the responsibility of the District. The District shall follow the guidelines of Subsection 1-909A.

Inventory:

Initial and quarterly inventories are to be performed by District inspection staff or the DMT as stated in Subsection 1-909A.

1-909C Material Stored Out of State (Except Raw and Partially Fabricated Materials)

All conditions and requirements as outlined in Subsection 1-909A apply with the exception of the following:

Approval Authority:

Requests for material stored out of state must be approved by the Construction Division Chief.

Cost of Inspection:

The first step in the evaluation of a request for payment of material stored out of state is for the ADE or their designated staff member to determine if there are extra costs to the Department involved in the initial and quarterly inspections of the materials. If extra costs are anticipated, the ADE shall consult the Office of Construction Division Chief for concurrence on the Department's disposition on the payment for material stored.

If the costs are deemed excessive or Department personnel are not available for periodic inspections, the Contractor may be required to agree to periodic inspections and self-certifications of the inventory including, but not limited to, a written statement with a full inventory, as well as photographic documentation of the materials. This shall be agreed to prior to further evaluation of the request for payment of material stored. If an agreement is not reached then material stored will not be paid unless approved by the Construction Administrator.

District Review:

Prior to forwarding the request for material stored payments to the Construction Division Chief, the District shall evaluate and make a recommendation as to whether the Contractor's request should be granted.

The request for approval, forwarded from the ADE, shall include all required documentation including the Schedule of Values, Certificate of Title (a copy of the entire Contractor submittal), storage site approval, testing recommendations, inventory and the District's determination as to the item costs and the validity of the proposed Schedule of Values.

Review Period:

The Contractor should be informed that due to the coordination necessary for the payment of material stored out of state they should expect a minimum of 30 days review prior to payment.

Inspection and Inventory:

Out of state storage sites for structural steel and precast concrete units should be evaluated by the DMT or their designated on site inspector. For other materials, District personnel (CI or above) may inspect the site only if it can be accomplished within a normal workday and out of state travel is authorized. If inspection of the material cannot be accomplished payment for material stored will not be granted unless specifically authorized by the Construction Administrator.

The request for out of state storage site inspection and material inventory will be made from the ADE to the Principal Engineer at the DMT. The District shall forward the detailed list of materials provided by the Contractor to be utilized for the inventory with the request for the inspection. If the material list is not of adequate detail or the markings are not adequate for the Department representative to complete the verification of the materials proposed for payment of material stored, then the Contractor's request will be denied.

Follow up Inspections:

If the Department and the Contractor come to an agreement for the Contractor to perform the periodic inspections (as mentioned in Subsection 1-909C) and if the Contractor does not submit the certifications as agreed, then the payments shall be deducted from the next payment estimate with the approval of the ADE.

1-909D Raw or Partially Fabricated Materials

Generally, raw or partially fabricated materials will **not** be paid for as stored materials. An exception may be made when raw materials are required to be purchased early in the project (e.g. steel for stage construction) and the Contractor can demonstrate that payment for such materials is in the best interest of the project. In those instances, consideration will be given for partial payment under the Material Stored on Site provisions.

Assistant District Engineer Review:

Prior to proceeding with the request for inspection of the storage site and inventory of material, the ADE will consult with the Construction Division Chief as to the Department's position on payment. If the Department conceptually agrees to the payment for raw or partially fabricated material, the District shall proceed as directed in Subsections 1-909A, B and C above – subject to the following additional requirements.

Schedule of Values:

For items that require extended fabrication, manufacturing or assembly time, the Contractor's proposed Schedule of Values shall be based on completion of major elements or completed assemblies or processes (i.e. fabrication complete, coating complete, delivery, installation, touch up painting, etc.) As stated in Subsection 1-909A the Schedule of Values shall include all costs that equate to the item price. *Payments shall only be made for definable elements and stages of completion of the materials. Partial payments for completion of a percentage of the item or element (work-in-progress) are not acceptable.*

The following information will be required to be submitted by the Contractor with the request for payment of raw or partially fabricated material, in addition to the standard requirements as outlined in the previous subsections:

- Original contract value.
- Original calendar days.
- Days used to date

- When the material will be incorporated into project.
- Justification for the request (stage construction, etc.)

Testing:

For raw or partially fabricated material the DMT will inspect the storage site as described in the previous subsections. The DMT will also evaluate the material based on its acceptability for use in manufacturing the final product and recommend whether or not it is acceptable. The DMT will forward their findings to the District to be submitted to the Office of Construction with the other supporting documentation.

Final testing will be performed when the material is 100% fabricated and a MAT-100 is submitted to the DMT for approval. To accomplish this, the inspector will generate a MAT-100 when the material is delivered to the site or as instructed by the DMT contact.

Review Period:

The Contractor should be informed that due to the coordination necessary for the payment of raw or partially fabricated material stored they should expect a minimum of 30 days review prior to payment. Requests for payment of materials found to be in non-compliance may be denied.

1-910 Payment to Subcontractors and Suppliers

Standard Specifications, State statutes and Federal regulations require the prompt payment to subcontractors for amounts due for labor performed or materials furnished when charges for such labor or materials have been included in an estimated progress payment by the State. Upon payment of an estimate that includes labor or materials provided by a subcontractor for work satisfactorily performed by a subcontractor, the Contractor must pay such subcontractor within 30 days of receipt of payment from the State, unless the Contractor believes they have a valid reason to withhold payment from such subcontractor. In which case, the Contractor must notify the subcontractor and the Department of the reasons for the withholding of payment. (For the purpose of this section the term subcontractor shall include suppliers.)

The prompt payment provisions also apply to any lower tier subcontractor. Subcontractors must pay their subcontractors for work performed or materials supplied within 30 days after such subcontractor receives payment for labor or materials furnished by such subcontractor.

For direction on how to handle prompt payment complaints received from subcontractors, unions and suppliers refer to Volume 1, Chapter 14.

1-911 Credits due State

Contracts can include construction work that is requested and benefits second parties such as public utilities or municipalities. When this occurs there is usually an agreement between the State and second party for the reimbursement of the costs associated with the construction work. The agreement will describe the improvement and estimated cost. The final cost is determined by an audit performed by the External Audits unit of the Bureau of Finance and Administration.

Before contract work begins the CI should review all agreements with second parties to determine what work involves credits due state. At this time it is also beneficial to review the Design Report as it may indicate what agreements should be in place. If any agreements are missing, check with the designer.

Contract work included in a contract or added to the contract for the benefit of a second party, such as public utilities or municipalities, must be distinguished from other contract work in the Project records. This is done so that a determination can be made of the value of the betterments and salvage at the completion of the work.

If during construction it is noted that the actual costs will exceed the limits set forth in the agreement, the District should initiate a supplemental agreement to cover the increased cost. When possible the supplemental agreement should be approved before additional work is performed.

When the construction work for the second party is completed the District will send to the Director of External Audits, Bureau of Finance and Administration a "Request for Audit of Credits Due State." To assist with the audit, the District's request will include the following:

- Name of Second Party
- State and Federal Project Numbers for the construction contract
- Copy of the agreement between the State and Second Party
- Information pertaining to all demand deposits made by Second Party
- Signed and dated calculation of Credits due State based on actual cost of work performed.
- Copy of the Certificate of Acceptance of Project, CON-501
- Copy of the Federal Voucher Report listing final quantities and costs for all items of work.

1-912 Estimated Payments

An "estimated" payment is an approximation of quantity of work completed during a certain period for the purpose of progress payments when actual quantities are not available. Actual quantities, for the purposes of this section are the quantities computed in accordance with the Method of Measurement and Basis of Payment for the item in question.

Estimated payments should only be employed when actual measurements cannot be completed. If estimated payments cannot be avoided, the actual quantities should be computed as soon as possible thereafter (typically within sixty days) and the estimated payments deducted in their entirety and replaced with the actual quantities on the same DWR.

The PE shall review estimated payments with each Payment Estimate (refer to Section 1-903).

The following procedure shall be followed when estimated payments are employed:

- The procedures and documentation of approval by the PE must be documented on the Volume IV, "Record of Estimated Payment" sheet.
- Estimated payments must be supported by field measurements and/or computations.
- Paying a percentage of the original quantity as an estimated payment and noting an estimated payment as a "progress payment" is not acceptable.
- Any remarks made in relation to the item must state "Estimated Payment" in the general remarks work item section associated with the current Construction Management System.
- Once the actual quantities are computed then the estimated quantities are deducted in their entirety and replaced with the actual quantities on the same DWR.
- This information must also be noted on the Volume III summary sheet if the item documentation is contained in a Volume III book.

1-912A Partial Payments

A "partial" payment is paying a part of a quantity calculated in accordance with the Method of Measurement and Basis of Payment for the item in question. Partial payments do not require deduction and correction. Partial payments should be based on complete and acceptable portions of the work. Partial payments must be supported by computations and a portion of payment should be withheld equal to the value of the remaining work to complete the item.

The following examples are listed to illustrate acceptable practices related to partial payments:

- Roadway Excavation:
 - In normal situations material is excavated, hauled, placed in final position in embankment and compacted, but slope finishing is not done. The cost of the remaining work may be calculated and the number of units equal to the value should be documented and withheld.
- Aggregate for Subbase and Base:
 - Material may be produced, hauled, placed, and compacted, but final grading has not been performed. The cost of the remaining work may be calculated and the number of units equal to the value should be documented and withheld.
- Miscellaneous:
 - Fence posts and wire or mesh may be in place and securely fastened but bracing wires not completed. The cost of the remaining work may be calculated and the number of units equal to the value should be documented and withheld.
- Structure Concrete:
 - If concrete for structures has been placed but items such as curing, removing forms and falsework, finishing, and other similar items have not been completed, the cost of the remaining work may be calculated and the number of units equal to the value should be documented and withheld.
- Structural Steel:
 - If structural steel is placed and deemed in acceptable condition yet some additional incidental work such as additional bolting of brackets to support a sidewalk or field touch up painting remains to be completed, the cost of the remaining work may be calculated and the number of units equal to the value should be documented and withheld.
- Plantings:
 - If plantings have been installed in accordance with the plans and specifications, the cost of the remaining work including anticipated plant loss during the establishment period may be calculated and the number of units equal to the value should be documented and withheld.

1-913 Lump Sum Items

Lump sum items may or may not have detailed guidance (i.e. in the Special Provision) on how to measure the work for payment. The Inspector must verify the Method of Measurement and Basis of Payment for a lump sum item before any payment is made.

For lump sum items that do not have detailed guidance on how the work is measured for payment, an agreement should be reached with the Contractor for the basis of determining progress payments before the work starts. One method for lump sum items with many distinguishable elements is to ask the Contractor to propose a Schedule of Values for the different elements and come to agreement on these values. As the work progresses base the payments on the elements that have been completed or portions thereof. Appropriate reductions should be taken for incomplete or deficient work. The Schedule of Values method is required with facility construction projects. Another method, which may be more appropriate for less complex lump sum items, is to pay a percentage of the lump sum bid price as work progresses based on the ratio of the number of working days an item of work has been in progress divided by the estimated total number of working days required to complete the item work. However, the CI should be aware that such a simplified method might not actually reflect the value of the work completed due to up-front costs, i.e. ordering materials, engineering costs etc. It is recommended to put lump sum calculations in the Volume III or the Volume V depending on the complexity and value of the item.

For lump sum items or other instances when the unit of material being paid under Material Stored on Site does not note the pay unit, a correlation between the two must be determined prior to any payments being made.

Note: Although reporting systems may allow for the entry of up to three decimal places when entering a quantity, this could result in rounding errors when closing the item out. It is considered best practice to use a maximum of two decimal places (1/100 unit). When the division of a lump sum by an odd number, such as an odd number of months, it may be necessary to pay one month at an odd percentage, and then the subsequent number of months by an evenly divided percentage, in order to avoid rounding errors. Refer to Figure 1-9.4 Accuracy of Measurements and Computations for guidance.

1-914 Accuracy of Measurements and Computations

Computations of volumes, areas, etc. are based on measurements made with the degree of accuracy consistent with the unit value of the item and the practical precision of measurement. The following is a guide to be used for measuring and computing quantities.

Bid Price (Dollars)	Quantities to nearest
0.01 to 10.00	unit
10.01 to 25.00	1/2 unit
25.01 to 50.00	1/10 unit
50.01 and above	1/100 unit

1-915 Estimated Items/Adjustment Items

Contract items may have a unit of measure of “Estimated”. The purpose of estimated items is to set up a budget or an allowance for this work within the contract. Normally the Method of Measurement/Basis of Payment is in accordance with Article 1.09.04 “Cost-Plus.” It is acceptable to pay under the estimated contract item number when it is paid in accordance with cost-plus. It is also acceptable to pay an agreed price for a portion of the work. In that case a new item would be created and paid according to the unit cost that was agreed upon instead of paying cost-plus. The estimated contract item should be reduced by a similar amount. The addition of the new item and the reduction of the estimated item shall be shown on the same Construction Order. All payments, related to the estimated item and any supporting documentation, are to be kept in Volume III.

There are several different types of adjustments that may have to be made for bituminous concrete, concrete and possibly other items on a project (i.e. Bituminous Concrete Density Adjustment, Concrete Adjustment, Insufficient Testing, etc.). The adjustment should be a contract adjustment, such as in the case of a Bituminous Concrete Density Adjustment. Adjustments should be discussed with the PE before being applied. Adjustments may include a withholding of payment due to insufficient testing, lack of required submittals or other reasons. Step by step adjustment worksheets are located in Approved Forms located in ProjectWise.

(Documents - 04.1 - Construction Libraries - 04.200 - Approved Forms and Inspection Checklists)

1-916 Water Pollution Control

A Water Pollution Control item is included in the Contract for a project if it is anticipated additional controls will be required to prevent soil erosion. This is an umbrella item intended to provide funding for these additional controls. Payments are not made under the Water Pollution Control Item; they are made under the applicable Contract items when available, such as riprap, hay bales, and turf establishment, or as provided for under Extra and Cost-Plus Work. Work paid under this item is incorporated through Construction Orders and either paid for on an item-by-item basis or as a single construction order item subject to the approval of the District.

A summary of Water Pollution Control activities must be maintained. The summary must include all item payments, including new or cost-plus items used and must be maintained in the project records, in the Volume III.

A reconciliation of payments must be made periodically from the summary log, as Contract items are paid and deducted from the funds in the Water Pollution Control item.

If additional control measures are required and the original fund for Water Pollution Control is exhausted, additional monies cannot be added to the item by a Construction Order. Additional funding must be requested through normal project methods.

Chapter 10 - Contract Completion

1-1000 General

This Chapter contains Substantial Completion, project acceptance, and close-out guidelines for projects. Project completion and close-out are important components of the overall project administration process. The project is not complete until it is accepted by the Department. Acceptance cannot take place until all physical and administrative requirements are complete. The following process has been developed to facilitate the timely close-out of projects. Recognizing that projects differ in complexity and size, time frames to close-out a project will vary; however, for most projects the close-out process should be completed within 3 months of Substantial Completion unless there are extenuating circumstances such as performance requirements or warranties.

The project inspection staff should regularly prepare for close-out of the project by completing project records, quantity computations, summary sheets, materials testing, as-built plans, and other administrative requirements *as the work progresses* or shortly after the physical work of an item (or group of related items) is completed in the field. Any problems or deficiencies discovered during item close-out should be noted and resolved in a timely manner while the Contractor is still on site. As the work on the project nears completion, the requirements to accept the work, including administrative requirements, must be discussed with the Contractor on a regular basis. A standing item should be included at project Progress Meetings to address these issues. Prior to scheduling the Semi-Final Inspection, the majority of the project items should be checked and balanced.

1-1001 Semi-Final Inspection

When the major elements of the project have been constructed, and checking and balancing the items confirms that the Contract value of the work remaining to be performed, including cleanup, is approximately one percent (1%) of the estimated final Contract amount, the Project Engineer (PE) should notify the Transportation Supervising Engineer (TSE) that the project appears ready for a Semi-Final Inspection. District management has the authority to use additional factors for determining the Semi-Final inspection, however, the Project Authorization End Date (PAED) should be considered. The PE will coordinate with the TSE to determine the date of the Semi-Final Inspection and the TSE will invite the required participants via Outlook meeting invitation. Key participants' availability should be checked prior to selecting a date. A minimum of fourteen (14) days notice should be given. For projects containing various locations across the District area or the entire State, it is recommended for the Semi-Final Inspections to take place as a town or area is completed in order to expedite the process. See subsection 1-1003A, "Various Location Projects," for specific guidance.

The following representatives are required to be invited to the Semi-Final Inspection:

- Contractor
- District Construction
- Office of Construction (OOC) TSE Liaison
- [OOC Advisory Team](#)

Representatives from the following units are required to be invited to the Semi-Final Inspection, if applicable to the project:

- Traffic
- Highway Design
- Bridge Design
- Environmental Planning

- Surveys
- Landscape Design
- Maintenance
- Bridge Safety
- Bridge Maintenance
- Highway Operations
- Relevant federal agency (for federal-aid projects)
- Town officials
- Utility companies

Projects may vary in scope and additional units or agencies may need to be invited.

Scheduling the Semi-Final Inspection of the physical work on the project will also prompt an assessment of the remaining administrative project requirements. Prior to the Semi-Final Inspection, the Chief Inspector (CI) will complete a review of the project records and provide an assessment to the PE. This assessment will evaluate the overall condition and completeness of the records (including, but not limited to: material requirements, Cost-Plus backup documentation, Certified Payrolls, DBE/SBE documentation, etc.) and estimate the administrative work effort required to close-out the project. A punch-list of administrative requirements will be compiled by the PE at the conclusion of the evaluation, submitted to the TSE, and ultimately sent to the Contractor with the Notice of Substantial Completion letter (see 1-1002 below). The CI and PE will establish a work plan to resolve the open administrative requirements.

At the Semi-Final Inspection, the participants must carefully review all details of the work completed to date. It is critical to determine and document the remaining work that must be done by the Contractor to fulfill the obligations of the Contract as well as any additional work that may be required to satisfactorily complete the project.

All findings of the Semi-Final Inspection must be carefully documented in a Semi-Final Inspection report (often referred to herein as punch-list or physical punch-list). Questions relating to the status or acceptability of the completed work, the work required on the remaining items, and any additional work required should be discussed and resolved at the time of the walk through. Should the Design Unit, Bridge Maintenance, Bridge Safety, Traffic, Maintenance, or any other participant not provide punch-list comments during the Semi-Final Inspection, they should be instructed to provide their comments within two (2) weeks of the date the Semi-Final Inspection was held so the Contractor can be notified in a timely manner of the remaining work to be completed.

1-1002 Notice of Substantial Completion and Stopping Contract Time

Substantial Completion is a critical milestone for all projects because it stops Contract time. Substantial completion is defined in Form 817 as:

The date at which the performance of all work on the Project has been completed except minor or incidental items, final cleanup, work required under a warranty, and repair of unacceptable work, provided the Engineer has determined:

- A. The Project is safe and convenient for use by the public
- B. All traffic lanes including all safety appurtenances are in their final configuration
- C. Failure to complete the work (including repairs) excepted above has not and will not result in the deterioration of other completed Project work, and provided further, that the Contract value of the work remaining to be performed, including cleanup, is less than one percent (1%) of the estimated final Contract amount
- D. If applicable, a Certificate of Compliance has been issued

When conditions of Substantial Completion have been generally met, the PE will notify the TSE that the Project may be substantially complete. The TSE will review the Project and remaining work and will discuss the matter with the Assistant District Engineer (ADE). If the TSE and ADE are in agreement with the PE's assessment, a Notice of Substantial Completion letter, noting the date which the Project was deemed substantially complete, will be prepared by project staff, signed by the TSE, and mailed to the Contractor. Included with the Notice of Substantial Completion letter will be a punch-list of physical work that must be completed before Final Inspection, and a punch-list of administrative requirements that must be submitted within thirty (30) days. Concurrently with the letter, a [Project Status Form \(CON-100\)](#) will be prepared noting the Substantial Completion date. The Substantial Completion letter (including physical and administrative punch-lists) and CON-100 should be distributed within fourteen (14) days of the actual Substantial Completion date. The executed CON-100 will be distributed in conformance with the CON-100 Instructions for Use and Routing.

1-1002A Final Material Certification

Once the Substantial Completion date is established, all items are to be checked and balanced. This should be completed within fifteen (15) days of the Notice of Substantial Completion letter. The CI should be checking all final quantities against their testing requirements. As soon as all testing requirements have been met, the District should send an email, with 'Final Material Cert – Item Qty Summary' report attached, to the Division of Materials Testing mailbox (DOT.MatTesting@ct.gov) requesting a Final Material Certification (FMC) for the project (refer to Volume 1 Chapter 4 Section 1-409). Projects over \$20 Million may request the FMC when 95% of the physical work is complete, if all testing requirements have been met.

1-1003 Final Inspection

The CI will record the dates that the Semi-Final Inspection report punch-list items were completed and will notify the PE when all items have been satisfactorily addressed.

The PE confirms that the punch-list items have been completed and coordinates with the TSE to schedule the Final Inspection via Outlook meeting invitation within seven (7) days of completion of the punch-list. The person leading the inspection must be at the TSE level or higher. If there are exceptions noted at the Final Inspection, the Contractor must be notified of the exceptions and ordered to correct them in accordance with the Contract. The CI will record the dates the remaining project work or corrective work is completed and include in the Project records. After all of the exceptions are addressed, the CI will notify the PE and TSE. If needed, a supplemental Final Inspection will be scheduled and a report prepared.

At the conclusion of the Final Inspection and after all corrective work has been completed and accepted, a Final Inspection letter, signed by the TSE, will be transmitted to the Contractor notifying that the construction work and punch-list items have been satisfactorily completed. This letter should be sent within 5 days of the Final or supplemental Final Inspection date. The letter will also order the Contractor to complete and return a [Certificate of Compliance \(CON-502D\)](#). See subsection 1-1006, "Termination of Contractor's Responsibilities & Certificate of Acceptance of Work," for specific guidance. Furthermore, the letter may include a "twenty (20) day notice" detailing the administrative punch-list documents that are still pending (see below).

When a Contractor fails to submit the documentation requested in the administrative punch-list included in the Substantial Completion letter, a twenty (20) day notice signed by the ADE should be sent to the Contractor with the Final Inspection letter. The twenty (20) day notice will list the outstanding administrative documents and/or information still needed from the Contractor to close-out the project. This letter needs to include a deadline date, approximately 20 days from date of the letter, for submission of the required documents and/or information, and notification that if the District does not receive the requested documents and/or information by the given date they will proceed to close-out the project without it, which

may result in price adjustment of the work and/or administrative action by the Department. A sample twenty (20) day letter is included in Appendix C.

1-1003A Various Location Projects

On projects consisting of two or more individual, geographically separated sections of roadways, a Final Inspection of individual, fully completed sections will be arranged in response to a specific request by the Contractor. A Contractor's request will only be considered when:

- All physical work associated with the partial relief of responsibility has been completed for which the Department or Municipality can take unconditional ownership.
- Traffic is in final alignment.
- Subsequent work on the project will not impact the completed section.

If the Contractor's request meets the above requirements, then a Semi-Final Inspection as described in Section 1-1001 will be scheduled for that portion of the work. A partial Final Inspection will be scheduled for the work in question when all work identified in the Semi-Final Inspection has been satisfactorily completed as determined by the CI and PE. Upon successful completion of the partial Final Inspection, the ADE will notify the Contractor that the specific portion of work is acceptable and that the Department accepts responsibility for the completed work. The appropriate Department offices including the responsible maintenance officials (municipal or state), the Bridge Safety and Evaluation Unit, District Bridge Maintenance and the OOC shall be copied on this relief of responsibility letter. Such partial acceptance of the work does not affect any other requirements governing the completion and acceptance of the Project as a whole.

1-1004 OOC Advisory Team Semi-Final Inspection and Final Pavement Evaluation

The OOC TSE Liaison and [OOO Advisory Team](#) are required to be invited to the Semi-Final Inspection for all projects. The ideal time to perform the OOC Advisory Team Semi-Final Inspection is with District Semi-Final Inspection. The OOC Advisory Team's Final Pavement Evaluation should be performed prior to the Final Inspection.

If the OOC Advisory Team Semi-Final Inspection does not find any items to be added to the physical punch-list and does not recommend corrective work, a Final Pavement Evaluation report may be completed and sent to the District.

If the OOC Advisory Team Semi-Final Inspection does result in recommended corrective work, they will prepare a Semi-Final Inspection report to supplement the District punch-list. The District should provide reasoning for any OOC Advisory Team recommendations they choose not to include on the punch-list of physical work. The District will notify the OOC Advisory Team when the punch-list work is complete so that the Final Pavement Evaluation can be performed.

The OOC Advisory Team is required to perform a Final Pavement Evaluation for projects with 2,500 tons or more of top course pavement. By definition, the total tonnage of top course pavement may be that of a single lift or multiple lifts of the *same* bituminous concrete mixture. For projects under 2,500 tons of top course pavement, the District is responsible for the [Final Pavement Evaluation](#).

1-1005 Certificates of Compliance (CON-502 Series)

Prior to issuance of the Certificate of Acceptance of Work (CON-500), the applicable Certificate of Compliance (CON-502 Series) must be completed and incorporated into the project records. One form must be completed and signed by each of the following: PE ([CON-502A](#)), CI (State Inspected) ([CON-](#)

[502B](#)), Resident Engineer or Project Manager (Consultant Inspected) ([CON-502C](#)), and the Contractor's Project Superintendent or other authorized representative ([CON-502D](#)).

1-1006 Termination of Contractor's Responsibilities & Certificate of Acceptance of Work (CON-500)

The construction work is considered complete when the Final Inspection has been held, any additional work and final cleanup has been completed, all equipment has been removed from within the project limits, and the Contractor has returned a properly executed Certificate of Compliance (CON-502D). If a properly executed CON-502D is not provided in a timely manner the OOC should be notified. When these requirements have been met, the TSE will have the [Certificate of Acceptance of Work \(CON-500\)](#), prepared by District Finals staff and will email it to the District Manager for electronic signature. The CON-500 is then sent to the OOC Quality Assurance Section for review and processing prior to forwarding to the Construction Division Chief for final electronic signature.

Transmittal of the CON-500 to the OOC Quality Assurance Section should occur within three (3) days of accepted date indicated on the CON-500. The form must clearly identify all sections of roads or transportation facilities covered by the project, as well as all bridges or structures and the maintenance responsibility. If the road is town-maintained, all agreements covering the work (type and date) must be recorded on the CON-500. The OOC will email the signed CON-500 Certificate of Acceptance of Work to the Contractor and all relevant DOT parties.

1-1007 District and Headquarters Reviews

The District is responsible for ensuring the project records, including source documentation, have been assembled in accordance with the *Construction Manual* and other pertinent directives, and that pay quantities have been measured and paid for in accordance with the *Standard Specifications* or special provisions of the Project. The District or the OOC will conduct sufficient intermediate review(s) of the project records to ensure compliance with these requirements.

The District will direct the CI to begin packaging the records for submission to the OOC Quality Assurance Section no later than 90 days after the submission of the CON-100 Substantial Completion.

Guidelines for performing a Headquarters Final Review of the project records are contained in Volume 1, Chapter 11. Upon completion of the Headquarters Final Review, the OOC QA Section will forward a report noting exceptions that require correction and/or response. The CI and PE shall resolve the noted exceptions within 30 days of the date of the Headquarters Final Review report and provide a written response.

1-1008 Checks to Final a Project

The timely close-out of project records is an important part of project activities and is necessary for a project to be considered a success. The CI and PE should work closely with the District Finals Section to complete all the necessary project close-out tasks and coordinate the archiving of project records.

The following are some important points or milestones in closing out a project.

- Records of Cost-Plus work must be checked. Particular attention must be directed to the labor and equipment rates, taking of discounts when available, insurance rates, and taxes on labor. The receipted bills must be checked and must correspond with the cost-plus forms. When found satisfactory, the cost-plus forms, receipted bills, equipment rate sheets and representative copies of payrolls are retained in a Volume III book.

- Project staff should confirm all testing has been completed in compliance with the Contract. The Project staff should run a 'Final Material Cert – Item Qty Summary' report in SiteManager and address any outstanding testing requirements prior to requesting the Final Material Certification.
 - A Final Material Certification will be requested from the Division of Material Testing as soon as the apparent final quantities are known:
 - On larger projects (projects greater than \$20 million) this should be initiated when 95% of the physical work is complete. To accomplish this, the District will forward to the Principal Engineer of the DMT, copies of the Federal Voucher Report or the SiteManager Item Quantity Report and the summary of all nuclear density compaction reports. A form for summary of nuclear density reports and the [CON 125 Soils – Data and Computation Sheet](#) can be found with the Approved Forms located on ProjectWise.
- (Documents - 04.1 - Construction Libraries - 04.200 - Approved Forms and Inspection Checklists)
- The Contractor must be notified of the apparent final quantities for the project once they have been established.
 - The final quantities must be checked in their entirety with the original contract and all construction orders to ensure that the final quantities are correct and in order. This can be accomplished by using the SiteManager Item Quantity Report and converting it to an Excel spreadsheet.
 - Contractor Evaluation forms are required for the Contractor and all subcontractors. See subsection 1-1016, "Contractor Evaluations", for specific guidance.
 - The Statement of Working Days, as submitted in detail on the [Construction Report](#), must be carefully checked with existing office records.
 - The Construction Report is checked for accuracy and completeness. If found correct, the Construction Report is initialed in the upper left-hand corner.
 - All Construction orders must be confirmed as approved in SiteManager.
 - As-built drawings are completed in ProjectWise and a "Completion of As-Built in ProjectWise" Email has been sent to AEC Applications.

The District Finals Section must maintain a log of all projects in the process of being closed out. The log should show the status of each project and identify the remaining tasks required to close-out the project. The CI must therefore coordinate all project close-out activities with both the PE and the District Finals Section.

1-1009 Final Estimates

The District will process the final estimate within 7 days from the date the Contractor has completed the work including the submission of supporting documentation, i.e. Material Certs, Certified Payrolls, supporting documentation for Cost-Plus work, etc. The final estimate should be processed before the records are sent to the OOC.

The final estimate should have a status of APRV in SiteManager, not MINM. If the last estimate has a status of MINM, the Project cannot be moved to "Completed" in SiteManager. In this situation, District staff should request a SiteManager database change to modify the status from MINM to APRV.

1-1010 Acceptance of Project

The project may be accepted when the work on the project is completed, the construction signs are removed, and all supporting information, reports and forms are submitted and accepted within established Department procedures.

The following items should be initiated or completed before acceptance of the project is considered:

- All project work has been completed;
- Certificate of Acceptance of Work (CON-500) (completed);
- Headquarters Final Review (completed);
- Final Change Order (completed);
- Final Estimate (initiated);
- All reports and forms required on Federal-Aid projects (completed);
- Final Materials Certificate has been issued;
- The correct submission of all documents required under the terms of the contract;
- All other project requirements have been satisfied or resolved (e.g. project time, SBE set-aside, DBE goals, etc.)
- Warranty requirements are met (i.e. all terms and conditions of the warranty must be satisfied). If the project includes an extended warranty that would delay acceptance of the project, the District should notify the OOC.

The [Certificate of Acceptance of Project, Form CON-501](#) and transmittal letter to the Contractor is prepared in the District Office within 7 days of the Headquarters Final Review or 7 days of the Contractor completing all of the contractual requirements whichever occurs later. The CON-501 is sent to the OOC for signature by the Construction Division Chief. OOC staff will complete the Form CON-501 and send it to the Contractor via letter.

1-1011 Final Package

To final a Project, a Final Package must be put together and sent electronically from the District to the OOC. The final submittal requirements for each category of the project are listed on the Final Package Supporting Documents Checklist.

The [Final Package Supporting Documents Checklist Memorandum](#) and supporting documents are to be emailed as *individual, separate* files to the OOC, Quality Assurance Section. The CON-501 Certificate of Acceptance of Project will be submitted to the OOC.

The following naming convention will be used to aid in the filing and retrieval of the electronic files:

XXXX-XXXX_BriefSubjectName
(Contract No)_(Description listed on Final Transmittal Memorandum)

Any documents not correctly labeled will be returned, thereby delaying the processing of the Final Package.

1-1012 Submission of Final Documents to Other Offices and Agencies

For projects with FHWA funding, the Federal Billing Unit needs to be notified when all final package documents have been completed. Shortly after the Certificate of Acceptance of Project, CON-501, is signed by the Construction Division Chief, the relevant final documents (CON-501, Construction Report, Federal Voucher, and Time Extension, if applicable) are attached to an email and sent to the Federal Billing Unit.

For projects with FHWA funding that are PODI (Project of Division Interest), the FHWA needs to be notified when all final package documents have been completed. Shortly after the Certificate of Acceptance, CON-501 is signed by the Construction Division Chief, the relevant final documents

(CON-501, Construction Report, Federal Voucher, Index of Construction Orders, Final Material Certificate, and DBE Form 88-1) are attached to an email and sent to the FHWA Division Office.

The Inspector is required to maintain a log book of any lighting repair work performed, which will include a description of the repairs, and the date the work was performed. The log book will be transmitted after the Contractor Relief of Responsibility to CTDOT Electrical Maintenance personnel.

1-1013 CE&I Consultant-Inspected Projects

After the construction work is completed on a CE&I consultant-inspected project, the consultant is required to complete all inspection-related paperwork and administrative requirements before their personnel are released from the project. The District should ensure that sufficient staff is maintained by the Consultant at the site to complete the paperwork within a reasonable time – generally, 30 to 60 days after completion of the work.

If, upon completion of all paperwork, it is not possible to process the final construction order or final estimate because of outstanding corrective work or administrative submittals from the Contractor, the District may deem it in the State's interest to terminate the consultant's project and complete the remaining processing with State forces. When this is the case, the project records should be examined by the District, and the consultant should make any necessary corrections before being released from the project. Consultants do not have to stand by on a project while the records are examined, but they must be available when requested to correct any errors or omissions.

Consultants must complete all project-related paperwork before they are released from their responsibilities under the Consultant Agreement.

Consultant Evaluations are discussed in Volume 1 Chapter 17.

1-1014 Storage of Revised Plans and Notebooks

As soon as the project is complete, the Inspector must put together a complete set of as-builts maintained during the project on BlueBeam. Refer to Section 1-314, "Final Revisions of Plans and Cross Sections (As-Builts)," for requirements. For consultant inspected projects, the consultant is responsible for preparing the as-builts unless other arrangements have been made.

The Inspectors' notebooks and all supporting project records are stored in an approved, safe and secure area at the District Office until arrangements can be made for storage at the Department of Transportation Records Center or archive storage at the District Office.

1-1015 Post Construction Review (PCR)

In an effort to improve the quality of project documents and to prevent recurring problems on our projects, the OOC QA Section requires a PCR for all completed projects. The information obtained is collected and uploaded to a database for future use and may also be disseminated as "Lessons Learned" to the pertinent units throughout the Department.

Within thirty (30) days of Substantial Completion (CON-100), a [PCR Form](#) should be completed by the CI, reviewed by District supervisors and sent to the OOC QA Section. The QA Section may request a formal meeting with the project personnel, including the Contractor, when they determine further discussion of the issues presented in the PCR is warranted.

1-1016 Contractor Evaluations

Each District evaluates the performance of all contractors with active projects in the District, both annually and at the completion of each project. Subcontractors are evaluated only at the completion of each project. The [Contractor Performance Evaluation Form](#) is prepared by field personnel on each project, preferably the Resident Engineer or CI with input from District support staff. It is then reviewed by the PE. Instructions to evaluate the Contractor are provided in the first tab of the form. To ensure consistency, it is critical that the instructions are followed.

Interim ratings shall be performed by District personnel for substandard contractor performance on a project. Interim ratings may also be requested by the OOC, the Office of Contracts, or at the discretion of District personnel.

A final rating is used to evaluate a Contractor's or Subcontractor's overall performance on a completed project.

The annual review covers the period from January 1st through December 31st. The annual rating is emailed to the OOC no later than the 15th of January. The final rating shall be completed and emailed to the OOC when the project work is complete. Interim ratings shall be forwarded by the District to the evaluated contractor after processing by the OOC.

In addition to emailing the annual, interim and final ratings to the OOC, the rating is to be emailed or sent to the evaluated contractor. Subcontractor ratings are not to be sent to the Contractor unless requested by the prime.

Recommended file naming format for the electronic form is:

“ContractorRating_ContractorName_YearofRating_ProjectNumber”

When rating a contractor, the reviewer should take the time to prepare a complete and accurate evaluation. This may be a composite effort between the project and District staff. The quality of work and workmanship are to be considered for all aspects of the work, including the administrative requirements of the project.

The reviewer is encouraged to include comments pertinent to the ratings given, especially if those ratings are at the extreme high or low end of the scale. Some examples of comments are as follows:

- Project staff has needed little to no supervision in order to operate on a day to day basis.
- Contractor's staff has anticipated constructability issues in advance of performing the work.
- Contractor handled lane shifts well as it entailed four lanes of over two miles of highway to be shifted.
- Timely ordering of catch basin risers may have prevented delays.
- Certified payrolls not received for last 3 months of project.

The forms from the Districts are compiled and the five (5) year average is used to determine an overall, representative rating for each contractor. They are used by the Department when determining the qualification of contractors, as well as responsibility issues. The OOC provides the five-year average to the Office of Contracts and other interested units or agencies as requested.

If any annual review or overall project rating is at or below a 2.0, the OOC will send a memorandum to the District requesting that the District meet with the firm to discuss the problems or deficiencies noted on the review.

If the five-year average rating is at or below a 2.5, the OOC will send the firm a letter (copy the Office of Contracts), noting that their performance was lacking in certain areas and that they need to improve on future projects.

If the five-year average rating is at or below a 2.0, the OOC will send the firm a letter (copy the Office of Contracts), putting the firm on notice that the firm is at risk of being found non-responsible. A finding of non-responsibility may impact a firm's future ability to be awarded work on Department projects.

Chapter 11 - Guidelines for the District Intermediate Reviews and the Headquarters Intermediate and Final Reviews

1-1101 District and Headquarters Intermediate and Final Reviews

The purpose of the District Intermediate Reviews and Office of Construction (OOC) Quality Assurance Section Intermediate and Final Reviews is to ensure that project records are maintained in conformance with current record-keeping procedures. This is accomplished by performing a review of certain documents contained in the project records after completion of the work but prior to project acceptance.

Normally, the records required to perform Intermediate Reviews and Final Reviews are:

- Volume I (Hardcopy DWRs prior to Chapter 3 Version 2.3 or SiteManager electronic DWRs)
- Volume II (Non-SiteManager Projects such as “Emergency Declaration Type I projects”,
- Volume III (Computations and item supporting back-up documentation)
- Volume IV (Miscellaneous Contract Data)
- Hard copy or scanned labor wage checks (1 large PDF is acceptable)
- Volume V (Field Notes and Reporting Forms)
- Delivery tickets
- A copy of the Contract
- A copy of half-size plans
- Environmental Log
- Construction Orders, upon request
- Electronic Records

Also, reports available from SiteManager and SiteManager Reporting assist in the review of the records. Refer to Figure 1-11.1 for the Final Review supporting documents checklist.

Intermediate Reviews:

On projects with an original contract value in excess of \$25 million, the Intermediate Review is performed by the Office of Construction Quality Assurance Section with the report forwarded to the District. The District is not required to respond to any exceptions noted in the Office of Construction Quality Assurance Section reviews, however, it is recommended that they do so to assure the exceptions were addressed.

On projects with an original contract value of \$25 million or less, the Intermediate Review is performed by the District. After the District performs the Intermediate Review, the report is sent to the project staff with a copy emailed to the Office of Construction Quality Assurance Section. It is recommended that the project staff respond to the findings in the report and forward a copy of their response to the District and Office of Construction Quality Assurance Section. Any subsequent reviews will ensure findings in previous reviews have been addressed.

All Intermediate Reviews are focused on payments of items and the supporting back-up documentation to substantiate the payments. Supporting back-up documentation is primarily determined from what is noted for the Method of Measurement/Basis of Payment for items found in the Standard Specifications, Contract Special Provisions and the Supplemental Specifications. Normally eight (8) to ten (10) items are reviewed during the Intermediate Review. Labor wage, payroll requirements, sufficient testing and other administrative requirements are also reviewed. Any subsequent reviews will ensure findings in previous reviews have been addressed.

Intermediate Reviews should be performed approximately once per year, per project. If new Inspectors or Consultant firms unfamiliar with the CTDOT record-keeping procedures are assigned to a project, it is highly recommended that the Intermediate Review be performed in the early stages of the Contract work.

The Office of Construction Quality Assurance Section will maintain a database showing project numbers and dates of all Intermediate Reviews of the project records.

Figure 1-11.1 HQ Final Review Supporting Documents Checklist

HQ FINAL REVIEW -- SUPPORTING DOCUMENTS CHECKLIST	
<u>Directions:</u> Check off all supporting documents in the appropriate box.	
<input type="checkbox"/>	All contract work has been completed
<input type="checkbox"/>	Volume I; (only for contracts prior to the re-release of Volume I Chapter 3 “electronic DWR’s”)
<input type="checkbox"/>	Volume II (for non-SiteManager Contracts);
<input type="checkbox"/>	Volume III;
<input type="checkbox"/>	Volume IV;
<input type="checkbox"/>	Volume V;
<input type="checkbox"/>	Delivery tickets;
<input type="checkbox"/>	A copy of a report showing apparent final quantities;
<input type="checkbox"/>	A copy of the contract;
<input type="checkbox"/>	A copy of half-size plans; and
<input type="checkbox"/>	A copy of Intermediate Review(s) performed by Headquarters or District and confirmation that the exceptions have been addressed
<input type="checkbox"/>	Construction Orders, upon request
<input type="checkbox"/>	A copy of the contract; PCR If not included with submission date of transmission to OOC: _____
<input type="checkbox"/>	A copy of half-size plans; and copy of the Completion of As-Built in ProjectWise attached.
<input type="checkbox"/>	CLAIM (Check this if a Claim is pending.)

Final Reviews by Office of Construction Quality Assurance Section:

A Headquarters (HQ) Final Review is performed by the Office of Construction Quality Assurance Section. Similar to the Intermediate Review, the Final Review is focused on item payments and the supporting back-up documentation to substantiate the payments. Supporting back-up documentation is primarily determined from what is specified for the Method of Measurement/Basis of Payment for items found in the Standard Specifications, Contract Special Provisions and the Supplemental Specifications. Normally, twenty-five (25) items are reviewed during the Final Review. Any subsequent reviews will ensure findings in previous reviews have been addressed.

A Letter of Transmittal of the records submitted shall accompany the project records being forwarded to the Office of Construction Quality Assurance Section for the Final Review. The records should not be submitted for the Final Review until all item quantities are final. Findings from this review will be transmitted in a report back to the District for resolution and response. The District will return the HQ Final Review to the Supervising Engineer (TSE) of the Office of Construction (OOC) Quality Assurance

Section, with detailed responses included, signed by the Project Engineer and the Field TSE assigned to the Project.

Response is required within thirty (30) days of the report. If the response is not received from the District within that timeframe, the Office of Construction Quality Assurance Section will follow-up with an email requesting response.

When all exceptions have been addressed to the satisfaction of the Office of Construction Quality Assurance Section, a No Further Action (NFA) stamp will be placed in the upper left section of the memorandum and distributed back to the District.

The Office of Construction Quality Assurance Section will maintain a database showing project numbers and dates of reviews of the project records.

Figure 1-11.2 Construction Records Review Matrix

	District Offices	Office of Construction
<u>State Administered Projects</u>		
Intermediate Reviews	All Projects under \$25 Million (Original Contract Value) <u>Note: A copy of review shall be forwarded to OOC</u>	All Projects over \$25 Million (Original Contract Value)
Final Reviews	Not Applicable	All Projects
<u>Municipality Administered Projects</u>		
Intermediate Reviews	All Projects <u>Note: The Monthly Checklist shall be considered the review</u>	Not Applicable
Final Reviews	All Projects <u>Note: A copy of the review shall be forwarded to OOC</u>	Not Applicable

The following sections provide guidance on what to review when performing an Intermediate or Final Review.

1-1101A Items

A random sampling of contract items shall be examined. Some of the items recommended to examine are:

- Processed Aggregate Base
- Concrete
- Excavation
- Drainage
- HMA
- Adjustment Items
- Hazardous/Contaminated Material

- Items with an “Estimated” unit of measure
- Water Pollution Control
- “Estimated Payments and items with an ‘est’ unit of measure”
- Trafficperson
- Stock-Piled Material
- Cost-plus
- Construction Order Items
- Mobilization and Project Close Out

1-1101B Volume I – Inspector’s Daily Work Report

Review the Diaries and Daily Work Reports (DWRs) for sufficient detail: Refer to Volume 1 Chapter 3 for additional information.

1-1101C Volume II – (Non-SiteManager Projects)

Refer to Volume I Chapter 18 and Chapter 21 for additional information..

1-1101D Volume III – Computations

Refer to Volume 1 Chapter 3 for additional information.

1-1101E Volume IV – Miscellaneous Contract Data

Refer to Volume 1 Chapter 3 for additional information.

1-1101F Volume V – Field Notes and Reporting Forms

Refer to Volume I Chapter 3 for additional information.

1-1102 Emergency Cost-Plus Projects

Emergency cost-plus projects have their own set of record keeping requirements addressed in Volume 1 Chapter 18.

1-1103 Facility Construction

For Facility Construction projects refer to Volume 1 Chapter 22 for additional information.

Chapter 12 - Subcontracting, Civil Rights, Labor and Contract Compliance

1-1200 General

Project staff have a responsibility to monitor Contractor's adherence to Civil Rights/Equal Employment Opportunity (EEO) rules and regulations prohibiting discriminatory activities and to also monitor the contractor's payment of state and federal prevailing wages to their workforce. Each District also has assigned office staff to perform this role as EEO Coordinator(s), who assists project staff in performing these functions. The Project Staff and EEO Coordinator also monitor the Contractor's compliance with provisions such as the Disadvantaged Business Enterprise (DBE) program, Small Business Enterprise (SBE) program, and timely submission of certified payrolls and payment of prevailing wage.

1-1201 Frequently Used Terminology

- **Pre-Award Commitment (PAC):** A Pre-Award Commitment package is submitted at the bid time on a project. It lists the various firms in the applicable program (DBE or SBE) that the Contractor has committed to utilize to achieve the respective DBE goal or SBE set-aside.
- **The Federal DBE Program:** The Disadvantaged Business Enterprise (DBE) program is a federal goal program and applies to Projects with federal funding. Projects may only utilize firms certified as DBEs to meet the stated percentage in the contract for federally funded projects.
- **Commercially Useful Function (CUF):** A DBE firm is considered to be performing a CUF when they are responsible for the execution of the work of the Contract and are carrying out their responsibilities by actually performing, managing, and supervising the work involved with their own force and equipment. The certified DBE firm must be responsible for procuring, determining quantity, negotiating price, determining quantity and paying for all materials (where applicable) associated with their work. Projects may only utilize firms certified as DBEs to meet the stated percentage in the contract for federally funded projects.
- **The State SBE Program:** The Small Business Enterprise (SBE) program is a state set-aside program and applies to projects without federal funds. Projects may only utilize firms certified as SBE set-aside to meet the stated percentage in the contract for State funded projects.
- **Title VI of the Civil Rights Act:** As a recipient of federal funds, the Contractor shall adhere to the Title VI requirements assuring that no discrimination will occur based on race, color or national origin in programs, activities, and services receiving federal financial assistance. This Title VI Assurance language is required to be physically incorporated with all subcontractor agreements when submitted with a CLA-12 on all federally funded contracts.
- **Federal Highway Administration (FHWA) 1273:** The FHWA-1273 must be adhered to and physically incorporated with all subcontractor agreements when submitted with a CLA-12 on all Federal Highway Administration (FHWA) funded contracts.
- **Davis-Bacon Act:** Federal Prevailing wage laws. Refer to the Contract for additional information.
- **EEO Coordinator:** Acts as liaison for the Districts and Office of Contract Compliance (OCC) to address Civil rights, DBE/SBE, US Department of Labor (USDOL) and CT Department of Labor (CTDOL) to assure work flows and procedures comply with the latest guidelines, specifications and law.
- **Affirmative Action Plan (AAP):** Contractors/consultants must have an approved affirmative action plan prior to being awarded a contract and subcontractors/subconsultants must have a plan approved prior to starting work. The affirmative action plan is a formal, written, results-oriented document that outlines specific steps the contractor/consultant will take to remedy the present effects of past discrimination and ensure the full utilization of minorities, women and other protected classes within the workforce.

- **Request to Subcontract Form (CLA-12):** Contractors and subcontractors are required to complete a CLA-12, and receive written permission prior to subletting, selling, transferring, assigning or otherwise disposing of any portion of the contract work, in accordance with the *Standard Specifications*, Article 1.08.01 – “Transfer of Work or Contract.” A CLA-12 shall also be completed for producers, manufacturers, truckers and services when they are a registered or certified SBE and DBE in the State of Connecticut in order to properly track and provide applicable SBE/DBE credit for the project.
- **Debarment:** Contractors shall ensure that no subcontractors, at any tier, are listed in the State or Federal Debarment lists at the time they enter into a contract.

1-1201A Role of Office of Construction (OOC) - Subcontracting Section

The Subcontracting Section within the OOC assures that all of the Districts operate consistently in complying with issues such as the latest Department procedures, guidelines, bulletins/directives, specifications, State and Federal laws and the use of the construction management system (SiteManager) when administering each project. The Subcontracting Section acts as liaisons with Contractors, Consultants, the District’s Construction Office Supervising Engineers and EEO Coordinator(s), to address contract, DBE/SBE and related issues and to provide requested information, accordingly.

Among the responsibilities of the Subcontracting Section are:

- Approvals of all project requests for subcontract approvals (CLA-12’s) for construction projects.
- Conducts a minimum of four random CUF Reviews per month per District to ensure compliance with DBE specifications.
- Reviews all DBE/SBE District shortfall submittals for content and completion. May request additional information from the Contractor, subcontractor and the District.
- Prepares periodic reports of construction DBE/SBE activity to other agencies or units.
- Ensures prompt payment complaints are adequately addressed and receives quarterly District Prompt Payment Logs for review.
- Maintains and provides training guides to current construction management system (SiteManager).
- Evaluates new technology and construction management system programs, as liaison to other agencies and units.
- Coordinates any complaints arising between DBE/SBE subcontractors and Contractors with the Office of Contract Compliance, as needed.
- Coordinates with the Districts to collect information related to FOIA requests, and maintains records to ensure prompt response.
- Coordinates questions pertaining to the prevailing wage rates and workforce classifications between CTDOT, CT Department of Labor (CTDOL) and US Department of Labor (USDOL), as necessary.
- Schedule and conduct quarterly meetings with OOC, District EEO Coordinators and OCC to discuss pending DBE/SBE/Civil Rights related issues and changes/revisions to workflows.

1-1201B Role of the District EEO Coordinators

The EEO Coordinators support the project staff with compliance of the contract criteria, such as prevailing wage, DBE and SBE requirements. They assist with issues that may occur between the Contractor, project staff, Office of Contract Compliance, Department of Labor (State and Federal), and other agencies.

Among the responsibilities of the EEO Coordinators are:

- Preparation in advance of the Pre-Construction Meeting:
 - Review the Contract, including all civil rights provisions in the Contract.
 - Review the PAC, DBE/SBE subcontractors and assigned work items.
 - Review the applicable DBE or SBE contract criteria and requirements for subcontractor termination, release, CUF and other necessary processes.
 - Inform the Project Engineer prior to the Pre-Construction meeting of all requirements for work force utilization, DBE goal achievement and other items.
 - Attend the Pre-Construction meeting and remain available to provide additional information as necessary.
 - Introduce PACMOD (Pre-Award Commitment Modification) form and guide document for its use by Contractor throughout project.

- Throughout the project:
 - Attend progress meetings, as necessary and monitor all EEO/Civil Rights issues.
 - Assist with issues involving any of the EEO/Civil Rights Contract provisions.
 - Perform four (4) random Site Record Reviews within each District, on FTA or FHWA projects each year (Fiscal October thru September) for compliance with Department requirements and submit to the OOC for review and transmittal to OCC.
 - Coordinate EEO/Civil Rights/subcontracting/payroll issues with the Project Engineer and the Inspector during Progress Meetings.
 - Track DBE/SBE payment verifications for all PAC subcontractors in SM and on a Form 88-1.
 - Track all PAC modifications (PACMODs) relating to any changes to the project original PAC values and subcontractors. The PACMOD form shall be completed by the Contractor and be accompanied by proper backup (i.e., subcontractor release or termination, CTDOT directed increase/decrease in project work that impacts a PAC subcontractor, etc.) and submitted to the administrating District and OOC for review and approval.
 - Monitor the Contractor's written documentation for Good Faith Effort (GFE) and their ability to meet both the Project DBE/SBE goal and the Project PAC for each DBE/SBE subcontractor. Utilize the PACMOD form any time there is a change or when there is a substantial increase/decrease to the Project work.
 - Initiate letters concerning EEO/Civil Rights, subcontracting, payroll issues and monitor project activity for compliance and follow-up with additional correspondence and meetings, as needed.
 - Compile prevailing wage data for Semi-Annual Labor Compliance Enforcement Report (Form FHWA-1494) and submit it to the OOC. The OOC submits a combined report to OCC for transmittal to USDOL with a copy to FHWA.
 - Review the status of applicable DBE or SBE goal/set aside on a monthly basis by use of an 88-1 form to find out if the Contractor is using their designated PAC DBE's/SBE's subcontractors and ascertain whether the goal/set-aside is likely to be achieved. If there is a question as to whether the goal/set-aside will be attained, promptly notify the Contractor by letter and contact the Project Engineer or Inspector to monitor the situation and discuss at all progress meetings. Follow-up with additional letters on an as-needed basis.
 - Ensure OSHA 10 documentation is submitted with the first payroll.
 - Ensure CT DOL payroll prevailing wage rates are updated annually in July.

- Completion of Project:
 - Determine if all required correspondence has been received and if all issues have been resolved. Notify the Contractor and prepare letters requesting missing documentation, etc., and review responses for accuracy and perform follow-up, as needed.
 - Maintain and update the Interim Form 88-1 throughout the life of the project based on bi-monthly payment verification submittals (quarterly for older contracts) by the Contractor, as required by the Contract.
 - A completed Final Form 88-1 will be compiled at the conclusion of the project (CON-500) to determine if the DBE goal/SBE set-aside has been achieved or if a shortfall exists.
 - If the DBE goal/SBE set-aside has not been met, the EEO Coordinator shall prepare a shortfall summary memorandum to the OOC with all necessary back up with a request for a GFE determination and include all PACMOD forms for the project.

1-1201C Role of the Inspector/Project Engineer relating to DBE/SBE/EEO/AA/CUF Requirements

All project Inspectors as well as the Project Engineer must be familiar with all of the Contract requirements and Pre-Award Commitments (PAC) at the start of their project. Each project is awarded with a PAC listing and detailing all work committed to be performed by all DBE/SBE subcontractors. All subcontractors are required to be approved with a CLA-12 prior to working on the project. This includes certified DBE/SBE subcontractors, suppliers and service contractors. The CLA-12 must include as a minimum the items identified in the PAC. Changes to the PAC can only be approved by the OOC in writing.

The Inspector should monitor the work items associated with the PAC subcontractors throughout the life of the project and note activities in the DWR (Daily Work Report).

If the Inspector notices any work that was originally assigned to a PAC subcontractor is not being performed by that subcontractor, written notice should be immediately provided to the Contractor's attention and the District EEO Coordinator and OOC should be consulted to assist with administrative procedures of the DBE/SBE Special Provisions. If the administrative procedures are not adhered to and properly documented, the Contractor may be subject to a potential shortfall/sanction, despite the Contractor meeting the overall project goal.

- Preparation in advance of the Pre-Construction Meeting:
 - Review the Contract to be familiar with all EEO and Civil Rights requirements.
 - Review PAC DBE/SBE subcontractors and assigned work items.
 - Review applicable DBE or SBE Contract criteria, PAC and other related requirements.
 - Attend and participate in the Pre-Construction meeting.
- Throughout The Project:
 - Monitor the EEO/Civil Rights issues and bring any concerns to the attention of the Project Engineer and EEO Coordinators. Ensure the Contractor provides timely written documentation, for such items as subcontractor modification, termination, release, CUF, and other necessary processes.
 - Attend the Project Site Record Review Compliance Meetings as applicable upon request.
 - Discuss the DBE/SBE goal status, EEO/Civil Rights, subcontracting and payrolls at the progress meetings. Document these discussions and their status in the Report of Meeting.

- Monitor that the required EEO/Civil Rights/Affirmative Action posters are displayed and updated by the Contractor on the project.
- Completion of Project:
 - Coordinate with the EEO Coordinator and the District's Final Sections relative to work performed by the applicable DBE or SBE subcontractors to determine if the goal has been met.

1-1202 DBE Goal or SBE Set-Aside Goal Contract Participation

If the Contractor is certified as a DBE/SBE, the participation counting toward the project goal shall be 100 percent. All other requirements relating to the approval of subcontractors will be enforced. For these types of contracts, changes to the PAC shall be handled in the same manner and any change to the pre-award approval shall be approved by OOC.

Certain contracts include DBE or SBE percentage requirements depending on the funding source. The DBE program is a USDOT program and only pertains to federally funded contracts. The SBE program is a State program and only applies to state funded contracts with no federal participation.

DBEs are certified by the CTDOT Certification Panel. The directory of DBEs is maintained by the Division of Contract Compliance and is available at: [DOT DBE Web Site](#)

SBEs are certified by CT DAS (Connecticut Department of Administrative Services). The directory of SBEs is maintained by the CT DAS and is available at: [SBE Portal](#)

Both programs are referred to throughout the manual, but only one program will apply to a given contract (DBE on federally funded or SBE on state funded project). **Project correspondence and meetings should only refer to the one applicable program to avoid confusion and possible conflicts.** DBE and SBE certifications cannot be intermixed and subcontractors must be certified in the applicable program in order to attain the project required credit.

The DBE goal or SBE set-aside requirements are a contract provision and, therefore, fall under the jurisdiction of the District Engineer, who will ensure that they are met. If the Contractor does not fulfill the requirements of the applicable DBE or SBE provision, contract payments can and may be reduced, in accordance with the contract specifications.

The Contractor's progress in meeting the DBE goal or SBE set-aside percentage requirements should be closely monitored by project personnel and reported on an 88-1 interim bi-monthly report. It is essential that the Project Engineer and Inspector become familiar with the applicable DBE or SBE goal that applies to the Contract, including the names of the subcontractors and the contract items originally declared at the time of the PAC when the Contract was awarded. Any modification must immediately be brought to the attention of the OOC Division Chief. The OOC Division Chief will make a determination of whether or not there is merit and to see if the Contractor's actions to modify the PAC are acceptable.

DBE - Commercially Useful Function (CUF):

In order to receive DBE credit, the Contractor shall ensure that all DBE subcontractors working on the project are performing work that they are certified to perform and items assigned in the PAC as stated below. Although CUF is the responsibility of the Contractor and the subcontractor, project staff is responsible for monitoring CUF by documenting any non CUF activity on their DWR and notifying OOC.

The following are essential components of a CUF for DBE subcontractors to obtain DBE credit for work performed:

- Perform work for which they are certified to perform based on their DBE certification.
- Utilize their own equipment.
- Utilize their own workforce.
- Supervise their own work.
- Are responsible for negotiating prices and ordering their own materials.

When any portion of the above CUF is not completed, DBE credit shall not be provided towards the Contract goal. The DBE specification addresses many types of remedies when it is determined that the DBE PAC subcontractor cannot or will not perform the assigned PAC work items. In addition, when new items are added to the Contract or critical path work is imminent, it is possible that the work previously assigned to a PAC subcontractor may need to be performed by the Contractor or assigned to another subcontractor. When these circumstances occur, it is critical that the OOC and the District be immediately notified in writing of the specific circumstances so that proper specification compliance steps are followed and documented.

DBE firms must perform their assigned work independently. If a DBE performs work on a project and uses another firm's labor, equipment or supervisory personnel without the approval of the Department, the Inspector must notify the Project Engineer and the EEO Coordinator immediately. The Inspector should then take action by notifying the Contractor immediately to ensure that the practice is corrected or documented appropriately. Payment shall not be made nor DBE credit received until the issue is remedied. The DBE specification requires that contractors that allow PAC work to be performed by others than the designated DBE, without the concurrence of the OOC, may be subject to non-payment or sanctions.

SBE – Set-aside Requirements:

SBE subcontractors must self-perform at least 50 percent of the work they were designated. Any questions or concerns related to work force utilization should be escalated to the OOC. The SBE specifications address many types of remedies when it is determined that the SBE PAC subcontractor cannot or will not perform the assigned PAC work items. In addition, when new items are added to the Contract or critical path work is imminent, it is possible that the work previously assigned to a PAC subcontractor may need to be performed by the Contractor or assigned to another subcontractor. When these circumstances occur, it is critical that the OOC and the District be immediately notified in writing of the specific circumstances so that proper SBE specification compliance are followed and documented.

Summary of Best Practices for DBE/SBE compliance:

To ensure that the Contractor complies with the Contract provisions in this area, the following procedures should be used:

- The details of the applicable DBE or SBE specifications and PAC are to be thoroughly discussed at the pre-construction meeting.
- Field staff will make sure that the DBEs or SBEs designated in the PAC are used for the items of work they were committed to do. Any Contractor requests for modification of a PAC shall be in writing and approved in advance by the OOC.
- Any perceived modification from items assigned to the subcontractor in the PAC shall be brought to the attention of the Contractor, Project Engineer and the EEO Coordinator who will investigate and determine what further action to take.
- Each project will maintain DBE or SBE records that will be used to monitor goal or set-aside compliance for the project. These records will be updated bi-monthly and kept in a project folder.

- Project and District staff will review the progress of the Contractor in achieving the goal requirement and remind the Contractor of their obligation to make Good Faith Effort (GFE) to achieve the goal. The Contractor shall continually make GFE efforts to meet the specified goal by allowing and encouraging DBE's or SBE's to compete for extra work.

1-1202A DBE/SBE Reports

Interim DBE/SBE reports (88-1) during the construction of a project are required bi-monthly as specified in the DBE/SBE specifications. The District EEO Coordinator is required to compile these reports summarizing DBE/SBE participation and verification of payments to each DBE subcontractor. A copy of these interim reports is to be submitted bi-monthly to the OOC. In the event that the Contractor receives an approval for a reduction in the PAC of the contract goal by Office of Contract Compliance, it should be noted on the report. The Contractor, in many cases, shall continue to document a GFE to provide additional work to that subcontractor.

1-1202B Final DBE/SBE Reports

A Final DBE or SBE Participating Report, Form 88-1 showing the applicable Contract DBE goal or SBE set-aside accomplishments and verified payments shall be prepared by the EEO Coordinator. This report needs to be prepared for all contracts, including consultant agreements, whether a goal was established or not. When the packet of DBE/SBE verification of payment documents is received from the Contractor, they are to be reviewed by the District EEO Coordinator. If the payment verification documents equal or exceed the PAC and specified contract goal for DBE or set-aside for SBE the District will complete the Form 88-1 and post in ProjectWise and notify OOC that the final package is in ProjectWise.

The report is sent to the OOC Construction Division Chief, or designee where the information is compiled for inclusion in reports on contract goal achievements.

1-1202C DBE/SBE Compliance and Shortfall Procedure

The following procedure must be used to verify the Contractor's compliance of DBE/SBE requirements as well as to ensure the proper specification procedures are followed when a shortfall occurs and to ensure proper GFE documentation is provided.

When the Contract has been completed, a letter is forwarded to the Contractor requesting documentation to verify payments to DBE/SBE subcontractor for work performed on the Contract. If the Contractor cannot obtain the payment verifications signed by the DBEs/SBEs, then the Contractor may provide copies of cancelled checks. If the Contractor does not provide the required information within 60 days, the District will send a second letter referencing the first letter and advising them that if the documentation is not furnished within 30 days, then reduction in contract payments may be made and the project will be closed out.

If the final review shows that there is a potential shortfall, the District will send a letter to the Contractor advising of the shortfall with the dollar amount that may be withheld if they don't provide acceptable written justification of a GFE with backup documentation.

A shortfall can occur even if the overall contract specified goal is met, but individual PACs have not been achieved.

If it is apparent that there may be a shortfall prior to sending the payment substantiation letter, then the request for the Contractor to provide acceptable written justification of a GFE with backup documentation may be included in the payment substantiation letter.

Documentation is to include, but not be limited to the following:

- A detailed statement why the Contractor did not or could not provide the committed value of work to the specified subcontractor. In cases where the PAC firm(s) did not perform any work, release letters along with approval from the OOC must be included.
- A detailed statement of the efforts made to select additional subcontracting opportunities shall be performed by DBEs/SBEs in order to increase the likelihood of achieving the stated goal and the reasons, if any, why DBEs/SBEs subcontracting opportunities were not available.
- A detailed statement, including documentation of the efforts made to contact and solicit bids with certified DBEs/SBEs, including the names, addresses, dates and telephone numbers of each DBEs/SBEs contacted, and a description of the information provided to each DBEs/SBEs regarding the scope of services and anticipated time schedule of work items proposed to be subcontracted and nature of response from firms contacted.
- Provide a detailed statement for each DBEs/SBEs that submitted a subcontract proposal, which the Contractor considered not to be acceptable stating the reasons for this conclusion.
- Provide documents to support contacts made with the Department (for DBE program) and DAS (for SBE program) requesting assistance in satisfying the Contract specified goal.
- In cases where the contract value increased above the original bid amount, the Contractor shall provide documentation of its efforts to increase DBEs/SBEs participation as a result of each construction order issued that increased the Contract value. The documentation shall include documentation of work remaining when the construction order was issued, efforts made to select additional subcontracting opportunities, reasons additional opportunities were not available, etc.
- Provide documentation of all other efforts undertaken by the Contractor to meet the Contract goal.

When the District receives the Contractor's GFE documentation, they will review the packet and prepare a summary memorandum transmitting the GFE packet to the OOC Construction Division Chief, with a complete copy to the Office of Contract Compliance (OCC). The memorandum should include the District's summary comments, the Form 88-1, the GFE package and any related correspondence such as modifications to PAC and summarize the significant events throughout the project. The District's summary comments will include comments on each of the documents indicating whether they are confirming or disagreeing with the submitted information, and why, or why not a document does not apply and/or was not included. The District SHOULD NOT make any recommendations or formulate conclusions or opinions.

Once the OOC and the OCC have reviewed the information furnished, they will make a determination if a GFE was performed by the Contractor and what, if any, remedy will be imposed. The OOC will notify the District of the findings by memorandum.

The same procedure described above must be followed for Consultant Engineering & Inspection (CEI) agreements with DBE/SBE goal requirements.

1-1203 (CLA-12): Subcontracting - Work Performed by the Subcontractor

Contract provisions (Article 1.08.01 of the Standard Specifications) require the Contractor to receive advance written permission from the Department to sublet any portion of the Contract. The Contractor must submit the Form CLA-12 inclusive with necessary pertinent documentation as required to the Construction Division Chief and allow ten (10) business days from the date of receipt by the OOC for processing. Incorrectly submitted CLA-12s (missing forms, incorrect CLA-12 version, incomplete submissions, etc.) will be returned to the Contractor for resubmission. The OOC will copy the District Project Engineer with incorrectly submitted/missing information on the CLA-12's. The OOC is responsible for the review and approval of all subcontractors by use of the Form CLA-12. District and project staff shall be familiar with this process so that they can be aware of the subcontracting requirements.

The Contractor must state on the CLA-12 form which items, or portions of items, which will be subcontracted; the name and address of the subcontractor, the estimated quantities to be performed, and the subcontracted unit prices. This information must reference the appropriate Project Number(s) and Line Item Number(s) as outlined in the “Line Item Category Report” in SiteManager; the pay unit; the unit price; the quantity, the subcontract item value and the percentage that it represents of the original bid quantity. The “Line Item Category Report” is typically provided to the Contractor at the beginning of each project by the Project Engineer. The CLA-12 must be signed and dated by the Contractor and subcontractor. Each subsequent lower tier shall submit a CLA-12 for approval individually and the Department will allow a maximum of three subcontractor tiers.

Additional CLA-12 requirements (i.e., approved Affirmative Action Plan, Ethics Affirmation, and Sub-Contract Agreement) must also be included, when applicable. Upon approval, the signed CLA-12 forms are distributed with an approval letter to the Contractor, the OCC and the District. A copy of the CLA-12 is to be incorporated into the project records. Instructions and forms are available to the contractors on the Department’s webpage: [Construction Web Site](#).

The following additional paperwork is also required to be included with the request to sublet (CLA-12):

- Form 6: Ethics Affirmation “Subcontractor and/or Consultant Affirmation of Receipt of Summary of State Ethics Laws” on projects that are valued at \$500,000 or more. The required form is available from the OOC webpage or from OPM’s webpage under Ethics Affidavits: [Office of Poilcy and Management Web Site](#)
- An approved Affirmative Action Plan Statement (AAP) for each firm is required to be on file with the OCC for each subcontract valued at \$10,000 or more. The Contractor should include a copy of the approval letter received from the Department with their CLA-12.
- FHWA Form-1273: If the project is funded in part or in whole by the Federal Highway Administration, a copy must also be physically included in each signed subcontract agreement.
- Title VI: If the project is federally funded, a copy of Title VI must be physically included in each subcontract agreement.
- Subcontract Agreement: A signed agreement shall be included for all DBE/SBE subcontractors. The subcontract agreements for other subcontractors (non DBE/SBE) shall be submitted, upon request.

Unless otherwise specified in the Contract, the Contractor must perform at least 50 percent of the original Contract work with their own workforce. The amount subcontracted is tabulated by the OOC when subcontracts are approved. Should a contract reach the maximum contract percentage of work allowed, then no further requests to sublet will be processed. If the Contractor wishes to reduce the amount of work assigned to a subcontractor in these cases, a revised CLA-12 noting the changes for the affected subcontractor must be submitted.

A summary of key terms:

- **Subcontractor** - An individual, firm, partnership or corporation to which a contractor sublets, with the approval of the Commissioner, any part or parts of the project covered by the Contract.
- **Manufacturer** - A factory, person, or organization that produces finished goods from raw materials, especially on a large industrial scale. (DBE/SBEs will receive 100% credit).
- **Supplier** - The act or business of providing, selling, or making available something that is wanted or needed by somebody or something. (DBE/SBEs will receive 60% credit).
- **Service** - A company or individual offering services to the Contractors or subcontractors not itemized in the Contract.
- **Trucking Firm** - A company offering trucking services with employees operating the trucks.

- **Owner-Operator** - Someone who operates a truck registered or leased in their name.
- **Salary Employees** - A fixed annual sum, paid at regular intervals, usually monthly, to an employee, especially for the professional, administrative or clerical work. A person who is paid salary should not be working with tools or operating machinery. This person is normally carried on the Contractor’s payroll without an hourly wage shown.

Note: If the person performs work considered to be prevailing wage work, then they and their wages must be shown on a certified payroll. They must be paid at or above the prevailing wages rates for the type of work that they performed. (Refer to Section 1-1204: Statements and Payrolls).

Figure 1-12.3: Summary of Requirements for CLA-12, Payrolls and Certified Labor Wage Checks

	CLA-12	Certified Payroll	Prevailing Wage/Labor Wage Checks
Subcontractor	Required for all original work and CO work.	Required for employees covered by prevailing wage laws	Required
Manufacturer/Producer	Required when DBE/SBE certified for counting credit.	Not Required	Not Required
Supplier	Required when DBE/SBE certified for counting credit (60% maximum).	Not Required	Not Required
Service	Required when performing Contract work.	Required for employees covered by prevailing wage laws	Not Required unless specified in the Contract. Any questions contact OOC.
Trucking/ Owner Operators:	Required when DBE/SBE certified for counting credit or employed by a DBE/SBE firm or “working within the project limits”.	Required for employees covered by prevailing wage laws	N/A
Trucking Firms Consisting of Two Truck or More	Always Required	Required for employees covered by prevailing wage laws	Required if “Working within the project limits” (onsite).

1-1203A Prompt Payment Complaints

Prompt payment complaints are taken seriously by the Department. All claims against contractors for labor or material payments are answered by notifying the claimant of the name and address of the Contractor’s bonding company. Letters are also sent to the Contractor and bonding company notifying them of the claim. For prequalification purposes, the District Engineer should notify the Manager of Contracts about claims against a Contractor for unpaid debts, unless the claim has been resolved by the Contractor in a timely manner.

Whenever a complaint is received (verbal/written/email) at any level, the recipient (OOO or the District) will provide the information to the Project Engineer as quickly as possible. The information should include date of complaint, Project Number, name of Contractor responsible for nonpayment, name of complainant and firm representing, how complaint was received (verbal/written/email), and date work was performed.

The Contractor is to be notified, in writing, of any prompt payment complaints. It is the responsibility of the designated Department recipient (either the Division Chief or the District Engineer) to prepare a standard prompt payment letter response to the Contractor. District prepared responses shall be copied to the OOC. If the Contractor does not respond to the first letter within the time frame requested of 10 days, the designated individual is to have a second letter prepared and sent to the Contractor clearly labeled "SECOND REQUEST." The bonding company is to be copied on the second letter. If the Contractor fails to respond to the second letter, the OOC is to be contacted for further instructions.

Each District and the OOC is to keep a log of the prompt payment complaints received for any contractor (or subcontractor) working on a Department project. One person at each District and the OOC will be designated as a clearinghouse for prompt payment complaints and maintain the Prompt Payment Log. On a quarterly basis, the designated District individual is to forward to the OOC the prompt payment log. If more than three complaints are received during any reporting period for any Contractor, regardless of the number of projects they are working on, the Assistant District Engineer is to be advised. The Assistant District Engineer will investigate and discuss the matter with the Construction Division Chief.

A new pamphlet has been developed for the Contractor and subcontractors, which is located on the CTDOT website: [Construction Web Site](#) that shows the necessary steps to be taken anytime a prompt payment issue arises.

Following these steps will provide the quickest method to identify these issues, identify all extenuating circumstances and allow the proper action to be taken to resolve it.

Prompt Payment Complaints Summary of Steps To Be Taken on Construction Projects.

1. Prompt payment complaints are taken seriously by the Department.
2. Under the terms of Department contracts (Sections 1.03.04 and 1.08.01 (Supplemental) of the Standard Specifications) and the Connecticut General Statutes (CGS), Section 49-41a-c, Contractors are required to make payment for accepted work to their tier 1 subcontractors/suppliers within 30 days after the Contractor receives payment by the Department for the work performed by the subcontractor.
3. This 30 day (maximum) requirement is thereafter applicable and carries forward for each subsequent tier subcontractor or supplier.
4. Contractors are required by CGS to notify the Department with a bona fide reason in advance of withholding payment from any subcontractor. The Department, upon review of the circumstances, may require that the amount in dispute be held in escrow.
5. All prompt payment complaints against Contractors/subcontractors of higher tier should be addressed in a similar manner to the District Engineer administrating the project, with a copy to the OOC and the Contractor.
6. The Department will then follow up with a letter to the Contractor requesting an explanation for their failure to make prompt payment with a required response within 10 days.
7. If the response is not reasonable or there is no response, a second letter will be sent to the Contractor with a copy to the bonding company to help resolve the issue as quickly as possible.
8. The subcontractor always has the right to file a claim against the Contractor's payment bond.
9. Failure of a Contractor to comply with the above noted provisions can result in further administrative action and such administrative action may result in a finding that the Contractor is non-responsible as a bidder for a Department contract.

In addition, for any dispute regarding prompt payment, a subcontractor also has the contractual right to use an alternative dispute resolution entity for resolution, as defined in Article 1.08.01.

1-1204 Statements and Payrolls

Contract provisions require the submission of certified payrolls showing the names of all employees working on the project (Article 1.05.12 of the *Standard Specifications*). For contracts containing Supplemental Specifications dated July 2012 or later, certified payrolls are only required for employees covered by prevailing wage laws. These provisions also apply to all subcontractors. In addition, State and Federal regulations require the submission of statements of compliance when prevailing wage rates apply. Two statements of compliance are required for each payroll on Federal-Aid contracts. The State Statement of Compliance and Federal Statement of Compliance are different. State prevailing wage rates apply to all new construction projects greater than or equal to \$400,000 and all remodeling, refinishing, refurbishing, rehabilitation, alteration or repair projects greater than or equal to \$100,000. Federal prevailing wage rates apply to Federal-Aid projects exceeding \$2,000 except for projects located on roadways classified as local roads or rural collectors, which are exempt. Projects exempt from federal wage rates are not exempt from State prevailing wage law.

The requirements and instructions for the submission of certified payrolls and statements of compliance are contained in the Special Provisions of every contract. These payrolls and statements of compliance are required to comply with state and federal laws.

The most recent versions of the certified payroll and statement of compliance forms are available on the CT DOL and USDOL websites. Current copies are also maintained in the Approved Forms in ProjectWise. (Documents - 04.1 - Construction Libraries - 04.200 - Approved Forms and Inspection Checklists)

The Contractor is to submit the completed forms to the District Engineer or their designated representative. Certified payrolls and statements of compliance are required to be submitted weekly on projects where federal prevailing wage rates apply. For projects where only state prevailing wage rates apply, certified payrolls and statements of compliance may be submitted on a monthly basis.

When applicable, the Contractor must provide a copy of the approved CTDOL Apprenticeship Registration Agreement (Form AT-5) for each apprentice on the project. This registration is not particular to the project, but it is particular to the sponsor (employer) and the apprentice (employee). In addition, the Contractor should submit "CTDOL Davis-Bacon Apprentice Certification Questionnaire" (Form AT-71) to the CTDOL in order to obtain project specific "Davis-Bacon Apprentice Certification" for prevailing wage purposes. The Contractor may go directly to the CTDOL web page for these forms and information particular to the apprenticeship program.

The Contractor is responsible for ensuring that all subcontractors furnish the necessary payrolls and certifications for each project.

- Federal wage regulations require weekly certified payrolls be furnished for each week in which work is performed.
- Connecticut Statutes require certified payrolls to be furnished every month until the respective firm's work is complete. Payrolls should be sequentially numbered. If no work was performed during the noted period, then the firm should indicate "***no work performed***" on the submitted payroll. Once the firm's work is complete, the final payroll should be labeled "***final payroll***".

On contracts bid on or after January 18, 2009 and where federal wage rates apply, each firm must list the last four digits of the worker's social security number. This four digit number serves as the required individual identifying number for the worker. The worker's address is still required by CTDOL to appear on the certified payrolls.

In order to ensure compliance with monitoring requirements, the following process must be followed:

Payrolls received in the District are to be logged into Site Manager. (Refer to the Site Manager's User Guide for this process).

- Each payroll should be checked for completeness and accuracy. The payroll should contain (at a minimum):
 - Last four digits of the Social Security Number or other identifying number (if federally participating project).
 - Both federal and state statements of compliance are attached.
 - Wages and benefits agree with the current wage rate schedule.
- One copy is to remain in District Office project records (paper or electronic formats are acceptable).
- One copy is to be sent to the project field office.
- The Contractor shall be notified of deficiencies in a timely manner. First notification may be by telephone, email or a Non-Compliance Notice allowing fourteen days to correct any deficiencies. Should a second notification be required, the District should draft a letter to the Contractor, alerting them to the deficiency and provide an additional fourteen days to respond. A copy should be sent to the Office of Construction.

The Department has a responsibility to monitor compliance with state and federal requirements; however we are not responsible for enforcing regulations without further guidance from the respective enforcement agencies. If a question regarding whether or not the Contractor or subcontractor is in compliance with these requirements, it should be forwarded through the proper channels to either the United States Department of Labor Wage and Hour Division, or to the Connecticut Department of Labor Wage and Hour Division, depending on the situation, for further action.

In accordance with CGS 31-53b and Public Act No. 08-83, on contracts awarded on or after July 1, 2009, the Contractors are required to document that workers performing prevailing wage positions have completed a course of at least ten hours in duration in Construction Safety and Health approved by the Federal Occupational Safety and Health Administration (OSHA-10) or, in the case of telecommunications employees, has completed at least ten hours of training in accordance with 29 CFR 1910.268.

Proof of compliance with the ten hour Construction Safety and Health course requirement consists of a student course completion card issued by the Federal OSHA, or other such proof as deemed appropriate by the Commissioner of the Connecticut Department of Labor, dated no earlier than five years prior to the commencement of the project. Each firm is required to affix a copy of the construction safety course completion card for each applicable employee to the first certified payroll submitted to ConnDOT on which the worker's name first appears. Any employee required to complete a Construction Safety and Health course, as required, that has not completed the course, shall have a maximum of fourteen (14) days to complete the course. If the worker has not been brought into compliance, they shall be removed from the project until such time as they have completed the required training.

Under Public Act 93-392, individuals may request to inspect and copy a Contractors' certified payroll records. With the exception of an employee's Social Security Number, these records are considered public records under the Freedom of Information Act. Please refer to Section 1-1208, "Freedom of Information" for how to handle requests.

1-1204A Salaried Employees

District staff should use the following guideline for reviewing payrolls if any of the Contractor's personnel are listed as salaried employees:

- A salaried employee must be acting in a supervisory capacity and must not be working with tools or equipment, regardless of the classification.
- If the reviewer finds that an individual is incorrectly listed as a salaried employee, the Contractor must be notified and required to provide an explanation.
- If the explanation is inadequate, the procedure is followed for complaints and apparent violations in Section 1-1202E, "Processing Complaints or Violations".

In accordance with Connecticut General Statute 31-53, all persons working on the site as either a mechanic, laborer or other listed classifications must be listed on a certified payroll and must show the hours worked and hourly rate. The hourly rate and hourly fringe benefits listed on the payroll must be greater than or equal to the prevailing wage.

1-1205 Wage Rate Checks

The responsibility for carrying out procedures to ensure compliance with prevailing wage requirements rests in part with the Department. The following procedures shall be followed.

- The project staff will ensure that a wage rate information poster (supplied by the Contractor) is available for viewing by all Contractor employees at all times that the project is under way, usually in a conspicuous place at the Contractor's field office.
- The Contractor is responsible to obtain and maintain the latest EEO posters such as civil rights, work safety, Davis Bacon and others. A guide document has been provided to assist DOT staff in monitoring this activity. The document can be found on the OOC Subcontracting Section web page.
- The project staff must conduct an examination of the Contractor's and subcontractors' employment records to determine the following:
 - That wages and benefits being paid appear to be at least the minimum prescribed in the Contract;
 - That the classifications appear to be correct; and
 - That the work being performed by the persons, including helpers and apprentices, appears to conform to the labor classification for which they are being paid.

The Inspector will perform labor wage interviews in accordance with the procedure outlined below:

- Wage checks shall be performed in accordance as stated above. The wage check year coincides with the release of updated wage rates by the CTDOL. Rates change upon the new fiscal year in July. Care should be given to adhere to the new wage rate requirements.
- The frequency of labor wage checks for subcontractors is the same as for the Contractor. One wage check shall be performed per labor class per wage rate year for all work classes appearing on the project for the given subcontractor.
- A List of Wage Checks will be kept in the Construction Management System (currently SiteManager). The number and frequency of labor wage checks may be increased if the reviews indicate problems.

1-1205A Wage Rate Check Forms

The Inspector will use Form CON-131, Labor Wage Check. All forms will be submitted to the District for completion. District EEO personnel will review the CON-131 to establish the following:

- That there is apparent compliance with the minimum wage rate provisions and that there is no apparent misclassification of labor.
- The District EEO staff must inform the Project Engineer and copy OOC promptly of any apparent violations and will guide the Project Engineer in the necessary steps to resolve the apparent violation.
- Depending on the circumstances, the Project Engineer may seek guidance from the District supervisory personnel and the OOC, as needed, but must take necessary action to correct any non-compliance issues related to these requirements as promptly as possible.

Contractors must pay the equivalent health, welfare and training benefits listed in the wage decision, either directly to the employees or to an approved plan. If the benefits are not listed on the certified payroll as being paid into an approved plan, they must be paid directly to the employee in the form of wages. The payment of the benefits should be checked against the payroll, and if a question concerning the payment of benefits exists, the Inspector must inform the Project Engineer and EEO Coordinator.

Apparent violations in payment of benefits are handled in the same way as violations in wage rates. All apparent violations of base wage rates or benefits that cannot be resolved by the District will be forwarded to the Department of Labor (DOL).

When project personnel are unable to complete Form CON-131 within 30 working days, the following actions should be taken:

- Forward the original copy of Form CON-131 to the District with a note or letter explaining the reason the incomplete form is submitted; and
- Record the appropriate notes on the field copy of the form, for informational purposes.

The District will follow through to address the problem and provide a copy of the Form CON-131 to the project office when the problem is resolved. If the District is unable to complete the Form CON-131 within 60 days of the actual date of the employee interview because of a certified payroll, or labor classification issue, the matter will be forwarded to the DOL, Wage and Hour Division for resolution using the Prevailing Wage Referral form. All other reasons for not completing the wage check within 60 days of the employee interview will be forwarded to the OOC and OCC by memorandum. OOC, OCC the District and project staff shall be included in the distribution list for all correspondence sent to the DOL. The incomplete CON-131 will be returned to the project by attaching it to the project's copy of correspondence sent to the DOL or OOC.

1-1205B Processing CTDOL/USDOL Complaints or Violations for Wages/Certified Payrolls/EEO

The following procedure is used on receipt of a complaint or discovery of an apparent violation:

- The District notifies the Contractor in writing, via certified mail return receipt, of the details of the complaint or violation. The Contractor should be required to respond with the methods to be taken to resolve the complaint or violation within 14 days.
- If the Contractor's response satisfactorily resolves the issues, no further action is necessary.

- If the response does not resolve the issues to the satisfaction of the District, the ADE notifies the DOL Wage and Hour Division of the alleged complaint or violation using the Prevailing Wage Referral form and includes copies of all documents pertaining to the issue. The DOL determines the appropriate actions and initiates further investigations, if required.
- Occasionally, the DOL may request assistance from the Districts in compiling documentation (wage checks, payrolls, etc.). District personnel will assist the DOL in compiling this documentation.

The District should inform the OOC of all labor wage complaints, investigations and violations.

1-1205C Compliance and Requirements for the CTDOL and US DOL

Most contracts will contain prevailing wage determination schedules. If there are federal funds involved there will typically be two schedules; one federal and one state. In case of a conflict, the higher rate applies.

The appropriate prevailing wage rates for each contract are typically requested from CTDOL and USDOL and inserted into the contracts prior to advertising by the Office of Contracts. Occasionally a wage rate for a particular position is not included in the listed rates. In these cases, the District should forward the Contractor’s request for the appropriate wage determination to the following:

<u>USDOL:</u>	<u>CT DOL:</u>
U.S. Department of Labor Wage and Hour Division The Curtis Center, Suite 850 West 170 South Independence Mall West Philadelphia, Pennsylvania 19106-3317 Phone: (267) 687-4023 Fax: (267) 687-4169 United States Department of Labor Web Page	Connecticut Department of Labor Wage & Workplace Standards Division 200 Folly Brook Blvd Wethersfield, CT 06109 Phone Number: (860) 263-6790 Fax Number (860) 263-6541 Connecticut Department of Labor Web Page

CTDOL maintains the revised prevailing wage rates on their web page. Both Contractors and administrating agencies, such as ourselves, get the updates for existing projects from their website.

The District EEO Coordinator should get the appropriate county/area rates from the web page for the affected projects and forward them to the respective project staff. The revised wage schedules are available at the following link: [Wage Rates by Town](#)

The Contractors should get the revised rates from the CTDOL page for both their use and that of their subcontractors. The Contractors need to fill in or register on-line and then proceed to the prevailing wage pages.

1-1206 Quarterly Construction Engineering and Inspection (CEI) Consultants Reports and Sub-Consultant Payment Log

Construction Engineering & Inspection (CEI) consultants are required to comply with all DBE/SBE requirements and specifications.

CEI Pre-Award Commitments (PAC) shall be submitted to OOC upon award of the Contract. The CEI shall ensure that DBE’s/SBE’s sub-consultants provide a Commercially Useful Function (CUF). After award and notice to proceed, any modification, change or termination to the PAC requires advance notification and approval by the OOC.

In order to provide a CUF, qualifying work must be managed by the CEI DBE or SBE sub-consultant to ensure they are operating under their own direction, using their own work force; equipment; performing only work they are certified to perform; and when applicable, they must also be responsible for procuring and paying for all material or supplies.

The CEI is required to complete and submit the sub-consultant Payment Log for all sub-consultants bi-monthly. The bi-monthly report shall detail verification expenditures approved to date for all sub-consultants including, PAC, DBE or SBE sub consultant. Submit the completed final summary form electronically to the designated individuals in the Office of Contract Compliance and OOC.

1-1207 Monthly and Bi-Monthly Contractor Verified Payment Reports

The Contractor shall submit a report, on a bi-monthly basis, to the District verifying the work performed and the dollars paid to DBEs or SBEs, depending on which program applies, for the current period and total to date. These reports allow the Department to monitor the Contractor's progress in achieving the specified DBE goal or SBE set-aside goal. When a PAC GFE reduction is granted by the Department at the time of award, the Contractor is required to submit a monthly report to the District with a copy to the OOC.

The District distributes these reports to the District EEO Coordinators and project staff. The District EEO Coordinator shall enter the verified payment information within 30 days upon receipt for each reported subcontractor into SiteManager under the Subcontractor section. This will allow for easier tracking and greater access of information.

The EEO Coordinator shall retain the reports with the project DBE/SBE records. Any discrepancies in the reports must be reviewed and resolved as expeditiously as possible. Any indications of Contract shortfalls should be reviewed with the Contractor at progress meetings, documented in the report minutes and promptly resolved.

1-1208 Site Record Review Monitoring by EEO Coordinator for Equal Employment Opportunity

The Construction Project Site Record Review shall be prepared on four random federally funded projects. These projects shall be selected by the District EEO staff throughout the year. These random reviews shall be completed by September 30th of each year. Class 1-Emergency Declaration Projects are exempt. Additional Site Record Reviews may be selected at the discretion of the District EEO staff or upon the request of the OCC. The reviews monitor and document the Contractor's accomplishments including subcontractors in Equal Employment and Affirmative Action and workforce utilization.

To perform a review, the following procedures are to be followed:

- Schedule review meetings at least four (4) weeks in advance.
- The EEO Coordinator shall invite the OOC, OCC, the Contractor's EEO Officer and District project personnel (at a minimum, the Chief Inspector/Project Engineer, and others as necessary).
- After the meeting is scheduled the EEO Coordinator shall send Packet "A" - Prime Contractor Data and Packet "B" - Subcontractor Data to the Contractor.
- The Contractor shall return the completed packets to the EEO Coordinator prior to the meeting.
- The Contractor shall notify the EEO Coordinator if they are unable to obtain a completed packet from a subcontractor and shall provide documentation at the meeting that shows efforts made to obtain that information.

- The EEO Coordinator, in conjunction with project personnel, will review all packets submitted by the Contractor. They are to check information to see if it is representative of what actually has occurred on the project. If possible, the packets should be reviewed before the meeting. The Contractor is to be asked to address all discrepancies.
- During the review, the Construction Project Site Record Review form is to be completed by the Project Engineer, Inspector or District EEO Coordinator.
- Shortly after the meeting, the District EEO Coordinator is to review the packets provided by the Contractor and Project Site Record Review form and determine if there are any areas of concern and, if warranted, recommend a full compliance review by OCC. Any errors found on the Site Record Review form are to be addressed. Errors are not to be erased. They are to be crossed out with the correct response inserted and initialed.

Upon completing the review, the EEO Coordinator will sign the Project Site Record Review Form and forward it to the Construction Division Chief for further processing. If packets are missing for subcontractors, documentation showing the Contractor's effort to obtain information is to be attached to the Project Site Record Review. The District should forward the Site Record Review, along with the accompanying packets and documentation, within 60 days of the review. Once all offices have signed off on the Project Site Record Review it will be returned to the District for the project records.

Note: Traditionally, on consultant inspected contracts, the CEI staff coordinate and oversee the site record meeting process.

1-1209 Freedom of Information

Please note that several documents that our units typically handle (ex. certified payrolls and training records) may include protected information such as social security numbers, DOB, full name and addresses, FEIN #s, etc. and other personal identification that requires redaction.

An example response to a FOI request to review documents that include information that must be redacted first is:

“This letter confirms receipt of your Freedom of Information Act (FOIA), request dated:

You have requested to review the following documents:

- 1) Contractor and sub-contractor certified payrolls.
- 2) Wage and rate information.

Please note that the requested payrolls listed in Item No. 1 above contain social security numbers. In order to allow you to review these documents we need to make copies of the payrolls to redact the social security numbers. Because of this process we will charge you \$0.25 per page for the payrolls and will provide you with the copies. Prior to making copies, you will be provided with a page count and the corresponding cost. Upon receipt of payment, we will make the copies.

You will be contacted shortly by a District representative to set up a meeting to review the other requested documents.

In the interim, if you have any questions about this issue, please feel free to contact me.”

Charges up to \$0.25 per page for copies or \$20.00 for use of portable scanner may be made in accordance with Public Act 94-112. Payment for copies should be made by check to the Treasurer, State of Connecticut.

Chapter 13 - Utility Coordination and Administration

1-1300 General

This section defines the District's role and responsibility as it relates to utility work, including Railroad, being performed on a construction project. The responsibilities of the District are described for the Design Phase, the Preconstruction Phase, and during the construction of the project. The roles of the Utilities Section and the Financial Management Office are also defined for the change-in-scope/cost overrun process. Further information is also contained in the policy and procedure manual entitled "Public Service Facility Policy and Procedures for Highways in Connecticut" issued by the Department's Utilities Section.

Throughout this Chapter where Project Engineer (PE) is referenced, consider it to mean the PE and/or the Utility Coordinator as assigned by the District.

1-1301 Design Phase

During design development, the District shall assign a PE to each project. The PE should attend the Utility Design meetings and become familiar with the work and utilities involved. The PE will also conduct plan reviews and field visits to assist the Utilities Section and the Office of Design in developing the scope of the utility relocation work and staging for the project. A general schedule for the relocation of work, an estimated cost breakdown as required and utility relocation plan sheets must be prepared by the Utility. The PE should assist the other units so that all issues are addressed through the plan review process prior to the Contract being advertised. A utility 'conflict matrix' (UCM) may be developed during the design phase to highlight potential utility conflicts that may be addressed prior to construction. The UCM should be obtained from the Utilities Section – PE for reference.

The UCM is the first step toward developing a broader strategy to relocate utility facilities from the transportation corridor. In addition to the usual approach of relocating utilities concurrent with the project construction, other strategies for minimizing the impact of the utility work upon the overall project schedule should be explored. Such strategies include: utility breakout projects and adding civil work to the construction project. The project team should assess the scope of work and the schedule requirements to determine the best strategy to accomplish the utility work while minimizing the impact to the construction project.

For additional information regarding Plan Reviews please see the [Plan Review Manual](#)

1-1302 Pre-construction Phase

The utility company will be notified by the Department to order materials before the start of construction. On the majority of projects before the utility can begin its field work, the State's construction Contract will most likely have been awarded and a Construction Project Authorization Letter (PAL) or an Agreement with a valid purchase order has been received by the District from the Engineering Administrator. The Order to Start Letter will be issued by the District Engineer (DE).

Under certain circumstances a utility can start relocation work prior to the award of the State's contract. In these situations the Federal Highway Administration (or other federal agency) will allow a utility breakout project to be initiated in advance of the construction project. If early utility work is authorized, the District will hold a utility pre-construction meeting and have weekly coordination meetings.

It is the Chief Inspector's (CI) responsibility to obtain utility agreements, plans, specifications and the estimates for the utility work from the PE/District Utility Coordinator/Office of Rail and the Utilities Section. These documents should be obtained and reviewed by the CI so that they are familiar with the

information contained in the documents prior to the utility coordination meetings and/or pre-construction meetings.

At the utility pre-construction meeting, the CI should obtain the name, title and telephone number of the person(s) responsible for each utility's daily work and contact information for that person's supervisor, as backup. At all pre-construction meetings the District will review and discuss the following:

- District Contacts
- Planned Scope of Work
- Survey
- Potential Problems and Concerns
- Maintenance and Protection of Traffic
- Schedules (Contractor and Utility Companies.)
- Administration of Utility Agreements

1-1303 Construction Phase

1-1303A Utility Coordination

The PE will ensure that there is regular communication and coordination among the utility representatives, CI and the Contractor's representative relative to work schedules (starting-completing, etc.), sequencing of the work, and traffic control.

A separate discussion will be introduced at all project progress meetings regarding project utility work. The discussion will include the following topics for each utility. Minutes of the meeting will be prepared and copies distributed to all those in attendance.

- Current schedule and status of the utility work.
- Potential or anticipated conflicts or problems.
- Each utility company's estimate of percent complete and schedule to complete.
- Problems or delays in accomplishing the work.
- Current budget status as reported by the utility.
- Anticipated completion date.
- Anticipated changes to the utility plans.
- Anticipated change in scope and the reasoning.
- Anticipated cost overruns as reported by each utility.
- Status of submission on CON 40 and CON 41 reports.
- Status of Railroad Force Account Reports.
- Buy America Certification

These items and pertinent discussions will be part of the report of meeting. The appropriate Utilities Section Engineer should be invited to all progress meetings where significant utility issues are expected to be discussed. Distribution of meeting minutes will include the Principal Engineer-Utilities Section and the Finance and Administration Unit. Separate Utility Progress Meetings may be warranted where the relocations involve multiple parties or extensive work. These meetings are vital to maintaining the project schedule. If utility representatives are non-responsive to these meeting requests the PE should elevate this issue to the District's Utility Coordinator and the utilities representative's supervisor for resolution. In the event that the issue continues, the PE should notify the District and Utilities Section Engineer.

Finance and Administration:

Should the project experience delays in having the utility or utilities perform required work after having provided a reasonable notice to the utility, within seven (7) days of a verbal request, the PE should elevate this issue to the District and the Utilities Section Engineer. If no resolution has been reached within twenty-one (21) days of the initial verbal request, a letter from the District Construction Office to the utility should be initiated. The Principal Engineer-Utilities Section and the Finance and Administration Unit should be copied on the letter.

All requests by the utilities to work reimbursable overtime must be submitted to the DE prior to performing the work. If approved, a copy of the approval letter sent to the utilities should be forwarded to the Finance and Administration Unit and the Utilities Section.

1-1303B Inspection and Record Keeping

The CI should require that the utility check-in at the start of each workday; providing the work force, major equipment, location, nature of work and anticipated end of workday.

It is the District's responsibility to ensure proper inspection coverage involving utility work during regular work hours. If a utility company schedules construction activity outside the regular work hours of the inspection team, overtime may be necessary. Generally, utility work is considered non-essential inspection. Exceptions to this rule may be allowed for critical work or when there is major impact to traffic or railroad operations. The approval process outlined in the Office of Construction overtime policy should be followed if additional inspection oversight seems warranted.

The inspector should record on their DWR and in SiteManager under "remarks" drop down menu Utility CON 40 Info, the labor classes and equipment that are present on the project site and how many hours were worked as well as the nature and location of the work. This documentation should include the following:

- Name of utility company performing the work – also list utility's subcontractor – if applicable.
- Type of work being performed.
- List of work locations by stations. If the work includes overhead utility, pole numbers are also required; railroad catenary structures should be noted.
- List labor, equipment, and major materials involved such as poles, conductors, ducts, manholes, pipes, valves, etc.
- Materials should be inspected for conformance to Section 1-402D Buy America Requirements on Federal Reimbursement Projects and projects that fall under the National Environmental Policy Act (NEPA). (Reference Chapter 4 Section 1-402D – Buy America Requirements)
- Note: The private and municipal utilities are also required to comply with the Buy America requirements in accordance with State Statutes if they are eligible to receive any reimbursement.
 - *In the case of Local Road Projects, the private Utilities are not eligible for reimbursement. Therefore, they are not required to comply with the Buy America Requirement.*
 - Figure 1.13.1: The following Certificate should be submitted by the Utilities along with their request for materials reimbursement.
 - Figure 1.13.2: This Certificate will be submitted with the Original Utilities Cost Estimate.

Figure 1-13.1 Certificate of Compliance for Buy America Requirement – Utility Billing

STATE OF CONNECTICUT, DEPARTMENT OF TRANSPORTATION

CERTIFICATE OF COMPLIANCE

FOR BUY AMERICA REQUIREMENT

UTILITY BILLING

Project No. _____ City/Town: _____ Vendor Invoice #: _____

(1) I hereby certify that to the best of my knowledge and belief that this bill is true and correct and that all costs for predominately steel and/or iron manufactured products herein, included in the Utility Construction Estimate, are properly chargeable to the Project as a result of the "BUY AMERICA" requirement as amended from time to time contained in 23 USC 313 and 23 CFR 635.410 to conform to the above named highway project as shown by the Utility's plan and estimate on file with the Connecticut Department of Transportation.

(2) The Utility shall furnish predominately steel and iron manufactured products for the Project that are made in the United States according to the applicable provisions of 23 USC 313 and 23 CFR § 635.410. "UNITED STATES" means the United States of America and includes all territory, continental and insular, subject to jurisdiction of the United States. All predominately steel or iron manufactured products incorporated permanently into the Utility's installations and adjustments for the Project must be made of predominately steel or iron produced in the United States and all subsequent manufacturing processes of such products including the application of coatings shall be performed in the United States. Manufacturing is any process that modifies the chemical content; physical shape or size; or final finish of a product. Manufacturing begins with the initial melting and mixing, and continues through the bending and coating stages. If a domestic product is taken out of the United States for any process, it becomes a foreign source material and is not compliant with the "BUY AMERICA" requirement.

AUTHORIZED UTILITY REPRESENTATIVE:

_____	_____
Signature	Title
_____	_____
Print Name	Name of Utility

Date	

Figure 1-13.2 Certificate of Compliance for Buy America Requirement – Utility Construction Estimate

STATE OF CONNECTICUT DEPARTMENT OF TRANSPORTATION

**CERTIFICATE OF COMPLIANCE
 FOR BUY AMERICA REQUIREMENT**

UTILITY CONSTRUCTION ESTIMATE

Project No. _____ City/Town: _____

DOMESTIC MATERIAL.(COMPLIANCE) I hereby certify to the best of my knowledge and belief that all the materials in the Utility Construction Estimate **DO COMPLY** with the BUY AMERICA requirement and the Utility abides as follows:

(1) The Utility shall comply with the "BUY AMERICA" requirement set forth in 23 USC § 313 and 23 CFR § 635.410, as amended from time to time;

(2) The Utility shall furnish predominately steel and iron manufactured products for the Project that are made in the United States according to the applicable provisions of 23 CFR § 635.410. "UNITED STATES" means the United States of America and includes all territory, continental and insular, subject to jurisdiction of the United States. All predominately steel or iron manufactured products incorporated permanently into the Utility's installations and adjustments for the Project must be made of steel or iron produced in the United States and all subsequent manufacturing processes of such products including the application of coatings shall be performed in the United States. Manufacturing is any process that modifies the chemical content; physical shape or size; or final finish of a product. Manufacturing begins with the initial melting and mixing, and continues through the bending and coating stages. If a domestic product is taken out of the United States for any process, it becomes a foreign source material and is not compliant with the "BUY AMERICA" requirement;

(3) The Utility shall promptly furnish documentation showing the domestic origin of all predominately steel and iron manufactured products before they are incorporated into the Utility's installations and adjustments for the Project upon request from the Department, and/or a duly authorized State/Federal representative.

NON-DOMESTIC MATERIAL.(NON-COMPLIANCE) I hereby certify to the best of my knowledge and belief that the noted materials in the Utility Construction Estimate **DO NOT COMPLY** with the BUY AMERICA REQUIREMENT and the Utility abides as follows:

(1) The Utility shall provide written notification,(attached to the Construction Estimate for the Project), specifying predominately steel and iron manufactured materials/products which are not produced in the United States in sufficient and reasonably available quantities which are of a satisfactory quality. Therefore, the Utility is requesting the Department, in accordance with 23 CFR § 635.410(c)(1) to seek a waiver from Federal Highway Administration (FHWA) for the installation of these materials. However, upon written notification from the Department, if a waiver of the "BUY AMERICA" requirement is not pursued by Department, or is not granted by FHWA, I certify that the Utility shall comply with the Buy America requirement.

AUTHORIZED UTILITY REPRESENTATIVE:

 Signature Title

 Print Name Name of Utility

 Date

1-1303C Review and Signature of CON 40s, CON 41s and Railroad Force Account Reports

The CON 40 (or an approved equivalent including Railroad Force Account Reports), shall be prepared by the Utility to report the daily labor, equipment, and materials (permanently) installed. The Utility shall submit the CON 40 to the Project Staff for review and signature.

A separate CON 40 shall be furnished for each utility company and each of its subcontractors, if applicable. The Inspector should be proactive to ensure that CON 40's are submitted in a timely manner. CON 40 should be submitted for each day worked. The District may use their discretion and allow a weekly CON 40 for work performed. This may be desirable for repetitive work. If utility work is bid out to a subcontractor, the District may entertain a submission of the Bid List noting work performed on a weekly basis, with Trafficperson submitted separately. All scenarios should be agreed upon at the initial utility meeting and discussed at coordination and progress meetings.

The heading of the CON 40 must be filled out completely and accurately. Each CON 40 must include:

- The utility name
- The percentage complete
- The utility sub-contractor (if applicable)
- Date(s) of the work
- The State project number (Federal No. - if applicable)

The sections of the CON 40 are filled out as follows:

- Labor
 - All labor by the utility or its representative, including inspection, engineering, supervision, traffic control, equipment operators must be included on the CON 40.
 - Labor must be shown by classification of employee(s), number of employees, and total hours of work.
 - All overtime must be segregated from regular time and shall be clearly indicated as "O.T." Overtime must also be authorized by the DE by letter.
- Equipment
 - Equipment must be listed by type, manufacturer, model, equipment # if available, size or capacity, with total number of units.
 - The total number of hours must be reported the same way as for labor. Equipment operators shall be listed under labor and not equipment.
- Materials
 - All major and minor materials installed for permanent use shall be recorded on the CON 40.

The CON 41 shall be used to report all temporary material installed as well as temporary and existing material removed. This report is prepared and submitted by the utility. Information reported on the CON 41 form determines depreciation and salvage credit on permanent material as well as credits for temporary material removed. The CON 41 is used to determine credits that are due the State.

The correct reporting of temporary materials used is important because the State receives at least 90% credit for materials returned to utility stores or for temporary materials installed that the utility company chooses to retain as their permanent facility. The previous CON 40s and 41s should be reviewed for accurate reporting and payment.

The CON 41 must be filled out completely and accurately. Each CON 41 must include:

- The utility name.
- Dates of work.
- The State Project Number (Federal No. - if applicable).
- The temporary material installed and/or materials removed.
- The disposition of removed material, i.e. Junked, scrapped or material returned to stores.

It is the Inspector's responsibility to verify that the work was actually performed by comparing the DWR against the CON 40 and CON 41. The CI should only sign in the DOT signature box if they agree that the information in the CON 40 appears reasonable and appropriate. The PE must initial any CON 40s noting overtime that they authorized. PEs may authorize overtime work in advance of the DE's approval letter when necessary to eliminate a hazard or to avoid an additional shift.

At times, some utility work may be non-participating. The Inspector should be familiar with the utility agreements and ensure that on Federal Aid Projects all non-participating work is segregated on the CON 40 and clearly identified as non-participating.

If a CON 40 or CON 41 does not appear reasonable and appropriate, the CI should attempt to resolve the discrepancies with the utility representative. If the discrepancies cannot be resolved, the CI shall include an explanation as to why the CON-40 or CON-41 should not be signed.

The utility company shall furnish the CON 40/41 to the Inspector. After the Inspector has signed the CON 40/41 a copy will be given to the utility company representative, a copy will be retained for the project records and the copy will be forwarded to the District Utility Coordinator for processing and transmittal to the Finance and Administration unit.

Review of Railroad Force Account Reports:

The Inspector will follow the same review procedures listed above for the CON 40/41 as far as documenting Labor, Materials and Equipment. The various railroad personnel utilized for both protective services assignments (i.e. conductor/flagmen, groundmen, railroad police) as well as force account work (track, power, communications and signals (C&S), structures, and others) are subject to various union work rules. Their billable hours may reflect time not physically on the project site due to allowances for travel time (deadheading) from their duty station or may require payment for a working lunch due, as examples. It is advisable to work with the railroad's project manager to become familiar with these policies, to be confident in the appropriateness of the charges being applied against the project. The Railroad will provide an approved Force Account Report containing the same information as the CON 40/41. Distribution of the various force account reports will be handled through the District Utility Coordinator, usually on a monthly basis. If there are any Railroads that have been non-responsive, field staff may contact the Utility Section for assistance.

- **Amtrak**

In lieu of the CON 40 or 41, Amtrak is authorized by Finance and Administration to submit the following supporting documentation for force account work.

- *Statement of Payroll Costs Report* - This report identifies all Amtrak labor utilized on a project for a one week period. The report includes each employee's name, dates worked and hours worked.
- *Materials Report* - This report identifies all materials incorporated into a project. This includes materials purchased or materials issued from inventory.
- *Equipment Report* - This report identifies all vehicles and equipment utilized on a project. The report includes description, date and hours used.

Amtrak's field representative will provide the Inspector with *Statement of Payroll Costs Report* on a weekly basis. This report identifies all labor utilized on a project for a week period. The Inspector reviews the labor report against their records. Any differences are reconciled with the Amtrak field representative who then provides the Inspector with a corrected labor report for the Inspector's signature. The *Materials Report* and *Equipment Report* are provided by Amtrak field representative to the Inspector for review, reconciliation and signature. The reports will be provided periodically as needed but within one month of the work. Upon signature of the respective reports, the Inspector will distribute copies consistent with Con- 40 distribution.

- **Metro North**

Processing of invoices is currently handled in the Office of Rail by the following:

- The Office of Rail receives the invoice from the railroad, sends it to the District for review and the District returns it to Rails with any discrepancies or verifies invoice for payment.

- **Other Rail Lines**

Procedures for force account activities to be followed are coordinated by the Utilities Section.

In SiteManager, under DWR "remarks" drop down menu Railroad Force Account, it is the Inspector's responsibility to record all onsite railroad personnel, equipment and materials covered by the force account agreement and verify that all railroad personnel are applying their charges to the appropriate railroad force

account work order established by Metro-North Railroad and authorized by the Office of Rail. The inspector must enter the railroad employee's name, employee number and work period in the remarks section of the Railroad Force Account screen on the DWR header as well as the work equipment, equipment number and quantity of materials (estimate if delivery slips are not provided by the railroad). Furthermore, the inspector should note the failure of railroad forces to show when scheduled and should also note cancellations by either the railroad or the contractor. Without this information the invoicing for these charges cannot be dealt with appropriately.

1-1303D Change in Scope and Cost Overrun Requests

All utilities are to be reminded to submit their formal requests for a change in scope/cost overrun to the District as soon as the need is recognized. The need for a change in scope/cost overrun can be initiated by the Utility Company, District or Finance and Administration.

The District Utility Coordinator is responsible for handling and processing all incoming change-in-scope/cost overrun requests from the start of the utility relocation work until 60 days after the completion date of the construction project. The PE and/or the Utility Section will provide assistance to the District Utility Coordinator in determining the validity of a request for change in scope/cost overrun. Cost overruns submitted by the utility company more than 60 days after the completion of the construction project (CON-500 date) will be addressed as outlined in Section 1-1303E.

Procedure to follow:

The need for a Change in Scope/Cost Overrun may be identified by the utility, District, Utilities Section or Finance and Administration Unit. If the Finance and Administration Unit or District identifies the need, they will request the utility to comply with the following steps:

- When requesting a Change in Scope/Cost Overrun the utility must forward a letter to the DE including a detailed explanation and estimate of cost.
- When the District receives the request from the utility for cost overrun they will forward a copy of the request to the Utilities Section for review and comment. The Utilities Section will respond to the District with any comments or exceptions within 7 business days.
- The District is responsible for the review of scope changes. The Utility Section may be consulted if necessary.
- If the District determines the request is to be authorized, the District must review funding needs with Finance and Administration. If additional funds are needed, the District will secure them.
- The PE / District Utility Coordinator will prepare an Authorization of Change-in-Scope/Cost Overrun letter.
- The District Utility Coordinator will process the Authorization of Change in Scope/Cost Overrun letter for signature and distribution by the DE. A copy of the utility's letter will be an attachment to the bcc list. Both the Utility Section and Finance and Administration must be copied on each Change-in-Scope/Cost Overrun letter.
- Upon receipt of the Authorization of Change-in-Scope/Cost Overrun, the Utilities Section will prepare and process an amended agreement if required.

Tracking System:

The District Utility Coordinator for each District, in conjunction with Finance and Administration, will track all requests for Change-in-Scope/Cost Overrun from the time the District receives the utility's letter to final resolution. The Utility Section will be responsible for maintaining a database of agreement values and approved Change-in-Scope/Cost Overruns for each Project. Finance and Administration will be responsible for ensuring that utility company expenditures do not exceed approved amounts.

1-1303E Handling of Requests More Than 60 Days After Project Completion

When a Change in Scope/Cost Overrun request is received more than 60 days after completion of the work as reported on the CON-500, the Utilities Section will be responsible to prepare the Change in Scope/Cost Overrun authorization. The District staff will provide information and support. The District shall incorporate the following steps into the process:

- Written concurrence from the District staff to the Utilities Section that the work described in the submitted cost overrun letter has in fact been completed by the utility company as specified on the State project.
- The Utilities Section will verify availability of funding with Finance and Administration. If a need for additional funding exists, the Utilities Section will inform the District to prepare and execute a project modification.
- Upon completion of the above steps, the Utilities Section will prepare and process the cost overrun authorization letter for the Engineering Administrator's signature.

Chapter 14 – Project Incidents and Complaints

1-1401 Reporting Damage or Injury Claims

When damage or injury claims (claims) are received from the general public, the following steps must be taken to minimize future involvement of the Department and to improve public relations.

- If the claim is made by telephone or in person, the complainant must be advised to submit the claim in writing to the appropriate office (District or Maintenance).
- For claims involving construction work, the Project Engineer (PE) should be notified of the incident immediately.
- Claims for apparent damage to private property associated with construction projects may be satisfied by an explanation of the final product or an explanation of already planned corrective work. Early correction of an unsatisfactory condition may avert future complaints. If the complainant persists on subjects beyond the scope of the construction work, advise the individual to submit the claim in writing to the District Engineer (DE).
- The written claim should be acknowledged by the District.
- The District should investigate the claim and document any project condition that may be associated with the claim. Photographs should be taken whenever possible to show physical features.
- Copies of all claim correspondence and the results of any claim investigations should be forwarded to the Bureau of Finance and Administration, Office of Operations and Support - Claims/Insurance Unit.
- The file on the claim should be kept open and monitored to ensure that the claim is resolved.

1-1402 Telephone Complaints

Telephone complaints usually involve inconvenience, displeasure, concern, or the like, but not property damage or injuries.

When a telephone complaint is received:

- Be courteous and obtain the nature of the complaint.
- Determine the office the complaint should be forwarded to.
- Provide the caller with a telephone number for the appropriate office.
- Provide the caller with the District Maintenance or Construction Office telephone number in case further follow-up is needed.
- Provide the caller with your number if they need further assistance.

The proper handling of complaints will save time and provide a positive image of the Department.

1-1403 Property Owner Complaints

All complaints from property owners that are received by project personnel must be investigated by the PE and Chief Inspector (CI) and discussed with the property owner for resolution at the project level. Any additional work necessary to satisfy the property owner must be cleared with the Office of Rights of Way (ROW) to ensure that the property owner has not already been compensated for the additional work. The ROW agreements list the items in the settlement, including any damages for which the property owner was compensated.

If the property owner is not satisfied and desires to pursue the complaint, the PE should instruct the property owner to send a letter to the DE, with information substantiating the complaint. The DE and Assistant District Engineer (ADE) review the complaint, investigate it, and meet with the property owner, if necessary. The District will reply by letter to the complainant with the Department's position.

1-1404 Improprieties

Allegations of improprieties by State staff or Contractor and subcontractor personnel must be taken seriously. Any field employee who receives an allegation of impropriety from a citizen should follow the procedures listed below.

- Obtain and record as much information as possible from the person making the allegation. Be objective in compiling the information. Do not argue about the incident.
- Ask for the complainant's name, address and telephone number where the person can be contacted by Management Services. If the complainant does not wish to be identified, provide the person with the telephone number of the Office of Management Services. Under no circumstances is the complainant to be advised to call any office other than Management Services with the allegations.
- Immediately inform the Project Engineer or Supervising Engineer of the allegation. Do not attempt to conduct an investigation unless directed to do so.
- The PE or Supervising Engineer should inform the DE or ADE of the allegations.

The DE can either investigate and resolve the allegation or contact the Construction Administrator. It is the responsibility of the DE to determine if notification to the Construction Administrator or Division Chief is warranted. If the allegations are escalated to the Office of Construction (OOC), the Construction Administrator or Division Chief will review and depending on the nature of the incident may notify Management Services.

1-1405 Motorists Claims

District procedures for handling motorist claims of damage caused by road conditions are summarized below.

- Each District designates an individual in the administrative office to be responsible for receiving and reviewing motorists' claims. When a claim is received, it is reviewed to determine the applicable liability. If the liability is not the responsibility of the Contractor, the claim should be forwarded to the applicable unit in coordination with the Department's Bureau of Finance and Administration, Office of Operations and Support – Claims/Insurance Unit. If the review indicates that the liability or responsibility is the Contractor's, a standard claim letter is sent to the Contractor. Contractor copies of the claim letter and letter to the Contractor are sent to the Contractor's insurance company by certified mail. If there is no response from the Contractor within 30 days, a second letter is sent requesting a response. Samples of the official letter and second letter to the Contractor, and the claimant letter are located in the ProjectWise Approved Forms folder.
(Documents - 04.1 - Construction Libraries - 04.200 - Approved Forms and Inspection Checklists)
- If the claimant writes or calls the District directly, the DE's Office assigns a file number to the claim. The first digit is the District number, the second two digits are the year, and the following digits are the number of claims received by the District for the year. For example, file number 115106 would be the 106th claim received in 2015 in District 1.

- The Contractor must also notify the Department's Bureau of Finance and Administration, Office of Operations and Support – Claims/Insurance Unit and keep them apprised, on a bimonthly basis, as to the status of attempts to resolve the claim until such time that the District considers the matter concluded.
- When a response is received from the Contractor, the information is entered on the Notice of Motorist Claim form. The District should check with the Department's Bureau of Finance and Administration, Office of Operations and Support – Claims/Insurance Unit to ensure that their office received a copy of the documentation as well.
- If no response is received from the Contractor within the time limit specified in the letter, the second letter to the Contractor shall be sent. This letter informs the Contractor that if no action is taken, payment may be retained as specified in Article 1.07.10 of the *Standard Specifications*.
- The Project Inspector should periodically review all roadways affected by construction and notify the appropriate parties of the need for any repairs.
- The Contractor is responsible for repairing potholes that develop within a contractual overlay, whether temporary or permanent, until relief of responsibility is granted or anywhere within the project limits if the Contractor is in the area. Repairs must be made as soon as possible. If the Contractor is not in the area, Maintenance should be contacted. If potholes or other hazards are discovered within the travelway in a construction area, the first priority is to correct the problem. The construction staff should coordinate with Maintenance if the Contractor is nonresponsive.

1-1406 Other Property Damage and Personal Injury Claims

All claims of property damage and personal injury – except motorist claims – must be forwarded to the Commissioner of Transportation. If the claim letter is received in the District Office, the original is forwarded to the Commissioner's Office, a photocopy is retained, and a review is initiated by the DE. If it is determined that the claim is within the project limits, letters are sent to the Contractor and the insurer notifying them of the claim. A letter will also be sent to the claimant acknowledging receipt of the claim and notifying the claimant that any future correspondence should be directed to the Contractor or the insurer. Samples of the official and second letters to the Contractor are in the Approved Forms folder in ProjectWise.

(Documents - 04.1 - Construction Libraries - 04.200 - Approved Forms and Inspection Checklists)

1-1407 Claims Against the State

Claims against the State of Connecticut, Department of Transportation, should include the following information:

- name, address and telephone number of the claimant; and
- an account of the accident or occurrence that led to the claim, including the date, the time of day, the precise location, the cause, and the property damage and bodily injuries.

The claim should be made in writing within 90 days of the date of occurrence and directed to:

Commissioner
 Department of Transportation
 Administration Building
 2800 Berlin Turnpike
 PO Box 317546
 Newington, Connecticut 06131-7546

ATTENTION: Department's Bureau of Finance and Administration Office of Operations and Support

1-1408 Claims Against the Contractor

If a written complaint or claim that involves the Contractor is received, a copy of the complaint or claim should be forwarded to the Contractor and the Contractor's insurer. When the letter acknowledging the complaint or claim is sent, the claimant should be advised that the Contractor and the Contractor's insurer have been sent a copy of the written claim or complaint. The letter to the complainant should include the addresses of the Contractor and the Contractor's insurer. The Contractor and the insurer must be requested to advise the Department of the action taken and the disposition of the claim or the complaint.

1-1409 Major Project Incident

Major project incidents include but are not limited to:

- a traffic accident involving a lane closure of more than a 20-minute duration;
- an incident resulting in complete closure of major routes;
- an incident that will not be cleared before peak traffic periods and therefore will result in public impacts;
- serious or possibly fatal injuries to the traveling public, a construction worker or Department employee;
- a construction accident, such as a crane tipping over, a form collapse, or a cofferdam collapse;
- a serious construction injury, such as a worker falling from a bridge, a worker being hospitalized, or a call to Lifestar;
- erection of a picket line;
- an incident that involves media attention;
- a fire or natural disaster impacting transportation facilities;
- environmental damage occurs;
- security threats that impact transportation facilities or traffic;
- an incident significantly affecting the traveling public, such as detour being required, a lengthy delay or an incident that will not be cleared by peak traffic/commuting periods.
- interruption of existing highway lighting;
- interruption of utility services;
- interruption of rail service;
- significant property damage;
- obstruction of a major waterway;
- third party incidents that have a major impact to transportation facilities;

If an incident occurs, the first and foremost action required of the project staff is the notification of emergency personnel and the safety and protection of the public and workers at the site. Once emergency personnel respond to the incident, project personnel must notify the District Office by telephone. See Figure 1-14.1 for the Incident Notification Process. In most cases, this notification can and should be made within 30 minutes of the occurrence of the incident.

When notifying the District of the incident, provide as much information as possible. The [Report of Major Road Closure/Project Incident/Emergency Work](#) form is available from the Approved Forms folder located in ProjectWise.

(Documents - 04.1 - Construction Libraries - 04.200 - Approved Forms and Inspection Checklists)

The District personnel who receive notification of an incident must complete the Report of Major Road Closure/Project Incident/Emergency Work form and immediately provide the information preferably by email (or fax) to both the OOC liaison engineer and the Highway Operations Center.

A follow up phone call must be made to the OOC liaison engineer, Principal Engineer, or Construction Division Chief confirming receipt.

- Provide updates on progress of incident to Highway Operations and OOC hourly or more frequently if necessary.
- Provide a report upon conclusion/clearing.

Figure 1-14.1 Incident Notification Process

INCIDENT NOTIFICATION PROCESS DURING NORMAL BUSINESS HOURS

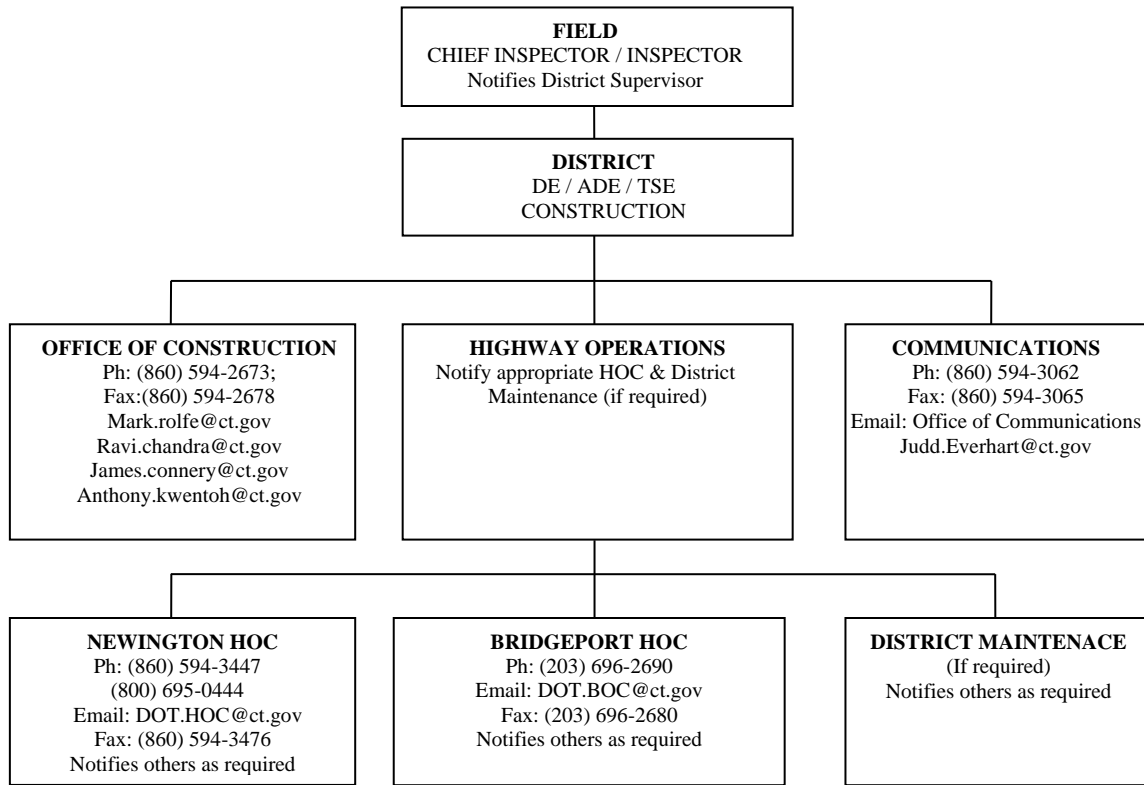

INCIDENT NOTIFICATION PROCESS AFTER NORMAL BUSINESS HOURS

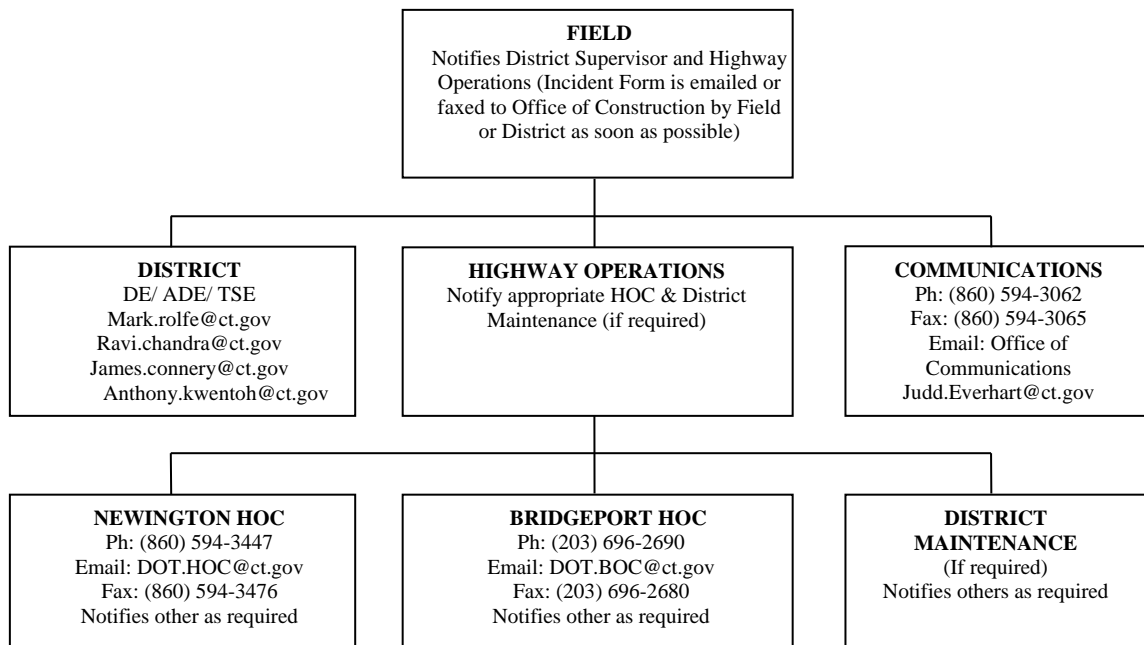
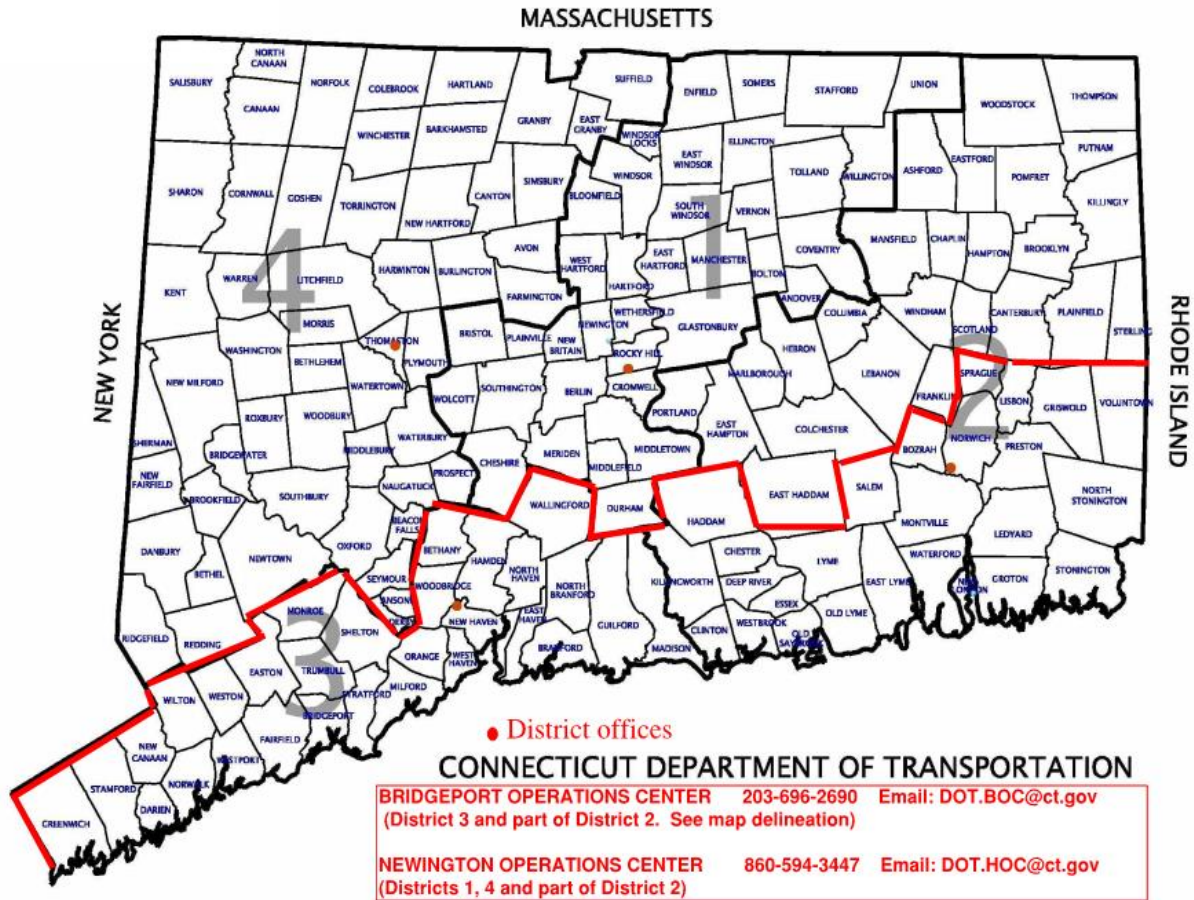

Figure 1-14.2 DOT Districts Operations Center Information



If a major incident occurs **after normal working hours**, District supervisory personnel and the Highway Operations Center must be notified by both email and telephone. Each District should have procedures in place for making the after-hours notification. The supervisory personnel receiving notification must determine if further telephone calls are required and, if they are, contact the District Engineer or the Assistant District Engineer.

After-hours incidents that require higher-level telephone calls include but are not limited to:

- a traffic accident involving a lane closure of more than a 20-minute duration;
- an incident resulting in complete closure of major routes; *
- an incident that will not be cleared before peak traffic periods and therefore will result in public impacts; *
- serious or possibly fatal injuries to the traveling public, a construction worker or Department employee; *
- a construction accident, such as a crane tipping over, a form collapse, or a cofferdam collapse; *
- a serious construction injury, such as a worker falling from a bridge, a worker being hospitalized, or a call to Lifestar; *
- erection of a picket line;
- an incident that involves media attention; *
- a fire or natural disaster impacting transportation facilities; *
- environmental damage occurs;

- security threats that impact transportation facilities or traffic; *
- an incident significantly affecting the traveling public, such as detour being required, a lengthy delay or an incident that will not be cleared by peak traffic/commuting periods;
- interruption of existing highway lighting;
- interruption of utility services;
- interruption of rail service;
- significant property damage;
- obstruction of a major waterway; *
- third party incidents that have a major impact to transportation facilities;

*The District Engineer (or Assistant District Engineer in their absence) is responsible for calling the Construction Division Chief or Construction Administrator to report the incident.

Depending on the nature of the incident, the Construction Division Chief or the Construction Administrator is responsible for determining if it is necessary to notify the Chief Engineer, the Deputy Commissioner and the Commissioner.

In addition to the above after hours' notification, a copy of the Report of Major Road Closure/Project Incident form must be scanned and emailed to the OOC as soon as possible.

There may be incidents that the Construction Administrator determines an after-action review is warranted. The Construction Administrator, on a case-by-case basis, may direct an after-action review be performed that will evaluate opportunities to improve the Department's response or operations.

1-1410 Report of Burglary, Theft, or Vandalism of State-Owned Property

The Inspector is responsible for reporting all incidents of burglary, theft or vandalism of State-owned property assigned to the project.

The following procedure is used whenever any State-owned property has been stolen, damaged or vandalized.

Immediately notify the local or State Police of the incident and as soon as possible notify CONNDOT security by phone at:

860-594-3333	Monday-Friday, 6:30 a.m. – 8:30 a.m.
860-594-3053	Monday-Friday, 8:30 a.m. – 4:30 p.m.

If the incident occurs on the weekend or holiday CONNDOT security is to be notified by phone as soon as possible on the next business day.

Within 24 hours of the incident a Report of Burglary, Theft or Vandalism form (found in the ProjectWise Approved Forms folder) should be scanned and emailed to the following:

Type of Equipment	Office	FAX No.
All	Office of Construction	860-594-2678
All	Security	860-594-3073
Computer	Department of Technology Services	860-594-3590

Chapter 15 - Compensable Time, Disputes, Claims, and Other Precedent Setting Actions***1-1500 General***

This section outlines the procedures to be followed related to a request for a compensable extension of time, disputes, claims, delays, or if the District wishes to revise contract General Provisions (Division I) or certain other specification requirements.

The District must contact the Transportation Principal Engineer who oversees the Claims and Litigation Section (TPE-Claims) for guidance prior to discussing certain direct costs and all indirect costs related to any of these situations. In addition, waiving or altering a Division I specification, special provision thereto or method of measurement of an item requires prior approval of the Office of Construction (OOC) Division Chief. The requirements related to each are explained in further detail below.

1-1501 District Notification and Approval Requirements

The following is a list of contractor requests or notices that the Assistant District Engineer (ADE) or District Engineer (DE) must bring to the immediate attention of the OOC, TPE-Claims (by forwarding copies of such requests) and must obtain concurrence related to proposed resolutions prior to discussions with the contractor:

- Receipt of a written informal claim.
- Receipt of a Request for Equitable Adjustment (an “REA,” which can be another term for an informal claim).
- Requests from the contractor for payment of delay related direct costs or indirect costs (field office overhead or home office overhead, sometimes called general conditions).
- Requests that utilize any compensable component of the *Standard Specification* Section 1.11 – Claims.
- Receipt of a request for extension of contract time that, if granted, may expose the State to liability for delay related costs.
- Receipt of a request for the adjustment of contract prices based on alleged differing site conditions or a significant change in the character of project work, if the aggregate adjustments would increase contract costs by \$250,000 or more.

In addition to the guidance above, these situations may be handled in accordance with Section 1-1503 as if they were a dispute. This is necessary because the Department of Transportation’s (Department) action may set a precedent, or the Department’s actions or inactions may have a significant effect on future demands or claims by a contractor.

In addition, certain contractual revisions require written authorization via email or memorandum from the Construction Division Chief or the Construction Administrator. Documentation of such authorization must be included with the Construction Order Addendum. The District must obtain such authorization for any of the following items:

- Directed acceleration of a project.
- Directed suspension of a project.
- Changes to Incentive or Milestone dates in the Contract or inclusion of new Incentives or Milestone dates.

- Change, alteration, modification, or waiving of Division I of the General Conditions of the *Standard Specifications* or any changes that may have been made to them by the Special Provisions or the Supplemental Specifications (for example this includes Contract Time and Liquidated Damages).
- Proposed modification or waiver of contract requirements, such as but not limited to: a change of the Method of Measurement for an item, a Type 2 revision of the Limitations of Operations, or a waiver of specification requirements.

The Districts must follow this procedure on all projects, including projects being partnered. Partnering may decrease the amount of time that the field staff has to resolve the dispute prior to escalating it to the next level. However, partnering does not change or alter the requirements of the Contract nor does it give the District the authority to settle disputes beyond the ability given to them by the Contract and the Construction Administrator.

1-1502 Contractor's Right to Claim

Connecticut General Statutes (C.G.S.) Section 4-61 is the basis for which a contractor holding a contract with the Department of Transportation (Department) may file a claim. This means that only the Prime Contractor may file a claim against the Department.

If a contractor files a formal claim against the Department, they must comply with the requirements set forth in C.G.S. Section 4-61 and the *Standard Specifications* Section 1.11 – Claims.

The application of any Article in the *Standard Specifications* Section 1.11 – Claims for informal claims must be pre-approved by the TPE-Claims.

The Department will evaluate the validity of the claim, and if warranted, will attempt to resolve the claim in a fair and equitable manner. If a claim is not resolved to their satisfaction, a Contractor may pursue it further in either Superior Court or formal arbitration. The sooner the Department makes a concerted effort to resolve a claim after it is received, the more likely a resolution will be achieved. The TPE-Claims is the Department's lead and liaison with other offices, including the Office of the Attorney General, Legal Services, Engineering, and the Districts regarding claims against the Department.

1-1503 The Dispute & Claim Process

This section describes the procedure which should be followed when handling contractor disputes and claims. The purpose of this process is to protect the State's interests, maintain consistency, and ensure that the appropriate resources are dedicated to a prompt resolution or a well-planned defense of claims made against the Department.

- **Dispute:** A contractual issue involving a conflict between the Department and a contractor concerning payment for extra work, increased costs, contract time, etc., which can be resolved by the District under the terms of the Contract.
- **Informal Claim:** A dispute or other matter that the TPE – Claims has determined will be handled by the OOC (see 1-1501).
- **Formal Claim:** A formal notice from the Contractor to the Commissioner satisfying the requirements of C.G.S. 4-61 and *Standard Specifications* Article 1.11.02.

A. Dispute and Informal Claim Resolution Process

With the approval of the TPE-Claims, a dispute may be handled as an informal claim (in accordance with Section 1.11 – Claims). The procedure for handling contract disputes and determining if a dispute will be handled as a claim is explained below:

The District may attempt to negotiate an equitable settlement of matters involving direct costs, for sums which can be justified, not to exceed \$250,000. For disputes involving direct costs exceeding \$250,000 in value or requests for indirect costs, go to Step 3.

Step 1. If there is a contractual dispute, it is important for the Inspector to document the issues and related contractor resources to the best of their ability in the SiteManager Diary or DWR. The Chief Inspector (CI) should also notify the Project Engineer (PE) of the dispute as soon as possible. The Inspector should research the facts and begin efforts to recommend a resolution to the PE. If the dispute is not resolved in a timely manner, the PE and the Transportation Supervising Engineer (TSE) must discuss the issue with the ADE. The District should then inform the Contractor that the issue is being reviewed by the ADE and project level discussions regarding the issue should discontinue with the Contractor unless otherwise directed by the ADE.

Step 2. The ADE should assume responsibility for coordinating further efforts to resolve the dispute. Throughout Step 2, the ADE should direct all District actions in regard to the dispute and participate in attempts to resolve it. If the dispute involves indirect costs (field or home office overhead) the ADE shall proceed to Step 3 of the process. If the ADE cannot resolve the dispute involving direct costs in a timely manner, he or she shall confer with the DE.

If the DE is unable to resolve the dispute related to direct costs not in excess of \$250,000.00 in a timely manner, the DE or ADE must then discuss it with the TPE-Claims as part of Step 3 of the process.

Step 3. Following the initial discussion with District Management, the TPE-Claims will guide the District on how to proceed. The TPE-Claims will inform District Management if the matter should be handled by the Claims and Litigation Section, if additional information is required to complete the assessment, and what the next steps will be. This may involve additional discussions as an independent audit or schedule analysis may be required. Depending on the scope of the issue, the TPE-Claims may discuss the matter with the OOC Division Chief and may forward the request to representatives of the Office of the Attorney General. In these situations the TPE-Claims is the primary contact with, and will be guided by, the Assistant Attorney General (AAG) for action concerning the dispute. Subsequently, the TPE-Claims will coordinate any necessary meetings.

All reports, opinions, recommendations, and other documents which the AAG advises the OOC to obtain, will be produced with limited or no copies and be treated confidentially and handled in a manner necessary to protect the attorney-client privilege which may apply to them. The use of email regarding such documents must be used appropriately to protect attorney-client privilege. If there are any questions regarding the use of email, the TPE-Claims must be contacted for further direction. The objective is to protect those documents from being disclosed to third parties except as the AAG may deem appropriate. The TPE-Claims, with concurrence from the Construction Division Chief or in certain cases the Construction Administrator, will use all means at the Department's disposal to produce a settlement of the dispute. In such cases the District should inform the Contractor that the issue is being handled by the Claims Section and then discontinue communications with the Contractor or its agents regarding the dispute. If further action by District staff is required, they will be directed by the Claims Section or appropriate legal counsel.

B. Formal Claim Resolution Process

If the claim has only progressed to the formal notice of claim to the Commissioner, the TPE-Claims and AAG will proceed with analysis and discussions in an effort to settle the claim prior to the Contractor

proceeding to formal litigation or arbitration. The TPE–Claims will review the information and discuss the matter with the AAG. In most cases, the TPE–Claims will arrange an audit of the claim and engage a claims consultant to analyze the claim for entitlement in preparation for potential litigation. Once the TPE–Claims receives the audit report, and if applicable the claim analysis, he/she will initiate settlement discussions with the Contractor. The TPE–Claims will use all Department means to attempt to produce a settlement of the dispute and must obtain concurrence from the Construction Division Chief or in certain cases the Construction Administrator as well as the AAG.

If a contractor or their attorney submits a formal notice of claim to the Department’s Commissioner and files suit in Superior Court, or files a demand for arbitration, the AAG representing the State will assume responsibility for the State's defense of the claim and/or in the ensuing litigation. The attorney's primary contact person within the Department will be the TPE–Claims who will arrange to have all necessary resources within the Department available to the attorney as may be needed to carry out the defense or settlement of such formal claims. This will include the District and inspection staff providing access to all of the project documents, providing input on the issues at meetings with the Contractor, and if warranted, providing testimony during litigation or arbitration. Again, all reports, opinions, recommendations, and other documents which the AAG advises the OOC to obtain, will be produced with limited or no copies and be treated confidentially and handled in a manner necessary to protect the attorney-client privilege which may apply to them.

The TPE–Claims will maintain a log of all active formal claims for the AAG and Department management. The log will reflect the claimed amount and description as well as the status.

1-1504 Waivers of Claim and Releases

Waivers of Claims (Waivers) and/or Releases should be utilized as described below to protect the Department’s interests when adding work to a project that may affect contract time or other contract work, when adding time to a project to document compensability/non-compensability, when resolving a dispute (example disputed quantities), or for other situations as approved by the TPE–Claims. Waivers and Releases must have District Management and TPE–Claims approval.

A Waiver applies to specific contract items or time extensions and the work affected by them. A Release applies to claims the Contractor may have for all conditions at the time of the execution of the Release.

Due to the subtle differences and legal implications in the use of Waivers and Releases, the ADE or DE must submit all Waivers and Releases to the TPE–Claims for review and concurrence.

The following procedure is to be followed in the development and execution of Waivers and/or Releases:

1. If there is a situation that warrants a Waiver or Release, or if the District is unsure whether a Waiver or Release is appropriate, the District TSE or District management should contact the TPE–Claims to discuss the situation prior to negotiations with the Contractor. Time extensions should be drafted and costs substantiation should be developed prior to these discussions.
2. After the initial conversation, the TPE–Claims will provide guidance to the District related to whether additional supporting documents are required, if an audit is required, and which form is appropriate for the situation. The TPE–Claims will maintain a log of pending Waivers and Releases.
3. The District will follow the guidance of the TPE–Claims when negotiating terms of the Waiver or Release. The District must forward the draft of the Waiver or Release to the TPE–Claims for review and concurrence. In addition to the draft of the Waiver or Release the District should

- forward supporting documentation including substantiation of costs and the draft time extension, if applicable.
4. Once the concurrence of the TPE-Claims is received, the District will have the Waiver or Release signed by the Contractor. The Waiver or Release must be incorporated into the Contract by Construction Order.
 5. A copy of each signed Waiver or Release must be returned to the TPE-Claims after execution.

A Waiver or Release does not preclude the Districts from required procedures as outlined elsewhere in the Construction Manual. The District must substantiate any new items, and/or time extensions to be contained in the Waiver or Release.

The District is responsible to receive all other necessary approvals for the execution of the Waiver or Release as defined elsewhere in this Manual (for example: certain situations warrant approval of the FHWA for Construction Orders).

1-1505 Claims and Disputes Status

Periodic meetings with the Construction Administrator, Construction Division Chief and the AAG will be held to discuss the status of active claims and disputes. In addition, periodic meetings will be held with FHWA.

Chapter 16 – Construction and Design Issue Procedures

1-1600 General

It is the responsibility of the Construction and Engineering personnel engaged in the administration of construction projects to notify the Transportation Principal Engineer in the Office of Construction (OOC), who oversees the Claims and Litigation Section (TPE - Claims), of potential design issues in accordance with these procedures.

Design issues may be the result of design errors, omissions, or oversights that may lead to increased costs, or make it infeasible or impracticable to complete the construction as designed and bid, or may require changes in the Contract, as defined in the *Standard Specifications*, in order to complete the original scope of the project. To facilitate the identification and evaluation process, the Construction Issue Form was created and will be processed in accordance with the guidance outlined below.

1-1601 Construction Issue Form

A Construction Issue Form is required for issues that: (1) prevent construction from moving forward, as designed; (2) require changes in the Contract in order to complete the original scope of the project; and (3) meets the thresholds stated below.

A Construction Issue Form is required when:

- an issue is expected to increase the cost of the project by 5% or \$250,000, whichever is less; or
- multiple impacts related to an issue or related issues that in aggregate increase the cost of the project by 5% or \$250,000; or
- an issue is expected to create a significant impact, as determined by the Assistant District Engineer (ADE) or the lead TPE from the Office of Engineering.

A construction issue may or may not entail a design error or omission that the Department will pursue. This determination will only be made in concert with the Design Issue Panel Chairperson, the Engineering and Construction Administrators, the Bureau Chief of Engineering and Construction, the representative from the Office of the Attorney General and, if warranted, the Office of Legal Services.

The latest version of the [Construction Issue Form](#) may be obtained from the Approved Forms located in ProjectWise.

1-1601A The District Responsibilities

The Construction Issue Form should be drafted by the Chief Inspector in conjunction with the Project Engineer (PE) and reviewed by the Supervising Engineer. The completed Form must be signed by the ADE and sent to the TPE-Claims. The Form shall include statements of facts only (no opinions, determinations or statements of design error). The facts must be supported with written contemporaneous documentation, such as letters from the Contractor, field memoranda, emails, design computations, or meeting minutes and must describe potential effects of the design issue, such as, but not limited to; delays, costs, environmental impacts, property impacts, or traffic impacts.

Staff must make every effort to estimate the final value of the issue when it arises and process the form in a timely manner.

If it is unclear as to whether a form is necessary, the PE or TSE should contact the TPE-Claims for guidance.

1-1601B The OOC Responsibilities

The OOC, Claims and Litigation Section will perform an initial review of the Construction Issue Form to determine: (1) if the issue is due solely to an estimate error leading to an increase in quantity necessary to complete the original work; or (2) if the issue is due solely to a differing site condition; or (3) if the project was designed in-house by State forces. In these situations, the form will be forwarded to the OOC Section responsible for developing Best Practices/Lessons Learned.

If the OOC review determines the issue is not related to the situations noted above, the TPE-Claims will forward the form to the appropriate lead TPE from the Office of Engineering for investigation. Once the Office of Engineering completes its investigation, the OOC will arrange a meeting with the Design Issue Panel.

Note: Upon receipt of a Construction Issue Form, the Office of Engineering will investigate the issue(s), confer with the consultant Design Engineer, the OOC, and others, as necessary or appropriate. After completing its investigation, which should be completed within sixty (60) days, the Office of Engineering's representative will attend the "Design Issue Panel" meeting.

1-1602 Active Claim by Contractor

If an error or omission is alleged in a claim made by the Contractor, the OOC Division Chief will forward appropriate sections of the claim to the Office of Engineering via a memorandum to the appropriate Design Division Chief. The Office of Engineering will forward appropriate information to the Consulting Engineer. If so requested by the OOC or the Office of the Attorney General, the Office of Engineering will engage the consultant engineer to provide support for the defense of the claim. At the discretion of the TPE-Claims, the analysis of the Design Issue may be tabled until the resolution of the Contractor claim.

1-1603 Design Issue Panel

The function of the Design Issue Panel is to evaluate construction and design issues to determine whether there is sufficient evidence that an issue is a clear omission or if there is substantial evidence that an error may exist.

The Design Issue Panel will consist of:

- The TPE- Claims will be the Panel Chairperson.
- One other member from the OOC (typically a Transportation Supervising Engineer or above).
- Two members from the Office of Engineering (typically designated at the level of TPE), who were not responsible for oversight of the project related to the specific design issue.
- An attorney from the Office of the Attorney General, (non-voting member) acting as counsel.

Confidential documentation of the issues and voting outcomes will be recorded and maintained by the Panel Chairperson and the Assistant Attorney General. If the Panel determines that there is not substantial evidence that a design error has occurred, no further action will be necessary. If, however, the Panel determines that a design error may have occurred, the Panel Chairperson will discuss the issue with the Engineering and Construction Administrators, the Bureau Chief of Engineering and Construction, and the Office of the Attorney General.

Chapter 17 - Consultant Engineers***1-1700 (a) – Consultant Administration***

The pamphlets listed below establish requirements for the administration of Consultant Engineers (consultants) and are available for DOT staff and consultants. They are located in the Approved Forms folder in ProjectWise:

(Documents - 04.1 - Construction Libraries - 04.200 - Approved Forms and Inspection Checklists)

- Consultant Agreements - the Consultant Agreement is the Contract between the CTDOT and the consultant. It contains specific requirements and guidance related to the consultant's contract with the Department.
- [Construction Engineering And Inspection Information Pamphlet For Consulting Engineers](#) - establishes the functions and responsibilities of consultants as required by the Department in carrying out the policies, procedures and practices as shown in the Construction Manual and other publications referred to in the Consultant Agreement and the Pamphlet.
- [Connecticut Department Of Transportation Pamphlet For Monitoring Consultant Performance And Payment Requests For Construction Engineering & Inspection Services](#) - establishes specific requirements to be followed by the Construction Division, the Division of Financial Management and Support, and outside consultant firms.

The following sections of this chapter provide additional procedural guidance.

Those responsible for administration of consultant agreements should familiarize themselves with the guidance in the pamphlets.

1-1700 (b) – Task-Based Consultant Services

Task-Based Construction Engineering and Inspection (CEI) consultant firms are available to provide inspection services for projects initiated on short notice and to supplement State forces with inspection duties. Examples of such assignments may include inspection of emergency declaration projects; inspection of projects when sudden changes in advertising schedules result in State forces being unavailable; or painting inspection, when portions of the project involve bridge painting.

The following procedures shall be used by each District (TE-3 or above) to determine the need for and assignment of these services:

1. Submit a [District CEI Task-Based Request](#) to the Office of Construction (OOC), District Liaison Engineer.
2. Determine and list the specific needs for an assignment, including staffing levels.
3. Prioritize each assignment.

The OOC shall:

1. Review each District request.
2. Prioritize all requests.
3. Assign projects to Task-Based CEI consultant firms, based on workload, expertise and availability.
4. Notify Districts and Task-Based CEI firms of project assignments.

Upon notification of project assignments from the OOC, the District shall organize and lead the assignment meetings, prepare an estimate for the services and coordinate with the Negotiations Committee, establish the budgets in CORE, and administer the consultant assignments.

The Districts and the consultants need to monitor the specific fund balances for each assignment. If it appears that additional funds will be necessary to complete the assignment, the District shall request an increase to the assignment from the Office of Agreements & Negotiations, and shall notify the OOC.

Task-Based CEI consultant firms are not to be used when there is adequate time to obtain inspection services through the normal selection process. These agreements are in place to supplement the District inspection staff when District resources are limited.

The current version of the [District CEI Task-Based Request](#) form is available in the Approved Forms folder in ProjectWise.

(Documents - 04.1 - Construction Libraries - 04.200 - Approved Forms and Inspection Checklists)

1-1701 Consultant Evaluations

Consultant engineers are evaluated semi-annually by the TE-3 in accordance with this Section. The evaluations are done electronically through the [Consultant Performance Evaluation webpage](#). A bi-monthly rating may be used to supplement the semi-annual rating.

1-1702 Semi-Annual Consultant Evaluation Procedures

Connecticut General Statutes require the evaluation of a consultant's performance on a semi-annual basis. The unit responsible for administration of the contract shall perform the evaluation. The evaluations are to be completed no later than the 20th of the month following the rating period.

The semi-annual evaluation will be used to rate the consultant's performance in the following categories: Administration, Procedural, and Technical. To determine the consultant's overall rating for a category, specific items will be evaluated under that category. Only those items that are applicable to the assignment will be rated. If the evaluator believes a question is not applicable, they shall mark the question as N/A. Comments are mandatory on the semi-annual evaluation.

Upon completion of each semi-annual evaluation the consultant is to be advised by the administering unit of the results of the evaluation. If requested by the consultant, the administering unit will afford each consultant the opportunity to schedule a meeting to discuss measures needed to improve the services which they provide to the Department.

1-1703 Consultant Performance Evaluation Rating Guidance

The following guidance is to be applied to rating items identified in the Consultant Performance Evaluation Rating Form. For each category below, the consultants will be rated one of the following: exceptional, very good, good, needs improvement, unsatisfactory, and not applicable during this rating period. The Department's expectations are outlined below:

- *Project Team, Staffing and Resources* – Team's experience, background, knowledge, credentials and available resources.
- *Project Coordination* – Ability to coordinate with Department offices, Federal, Local, other State agencies, and the general public in accomplishing the assignment. The ability to coordinate the work of the contractor, subcontractor, utilities, department units, railroads, etc.

- *Communication and Responsiveness* – The ability to keep the Department informed on relevant issues and the ability to respond to correspondence, including but not limited to emails, phone calls, and faxes.
- *Quality of Work* – The ability to collect, generate, apply, interpret and present information. The accuracy, reliability and completeness of submissions, data, and deliverables required for the project – including but not limited to plans, specifications, estimates, reports, reports of meetings, permit applications, property maps, and surveys.
- *Timeliness of Submittals* – All submissions, data, and deliverables required to complete the project, including but not limited to plans, specifications, estimates, reports, reports of meetings, permit applications, property maps, surveys, project records, or any other deliverables requested by the Department.
- *Knowledge of Department Policy, Procedures, and Technical Expertise.*
- *Contract Proposals and Extra Work.*
- *Invoicing.*
- *DBE/SBE Goals.*

1-1704 Consultant DBE/SBE Administration

The process for administration of Consulting Engineers is the same as with Contractors. Refer to Chapter 1-12 of this manual for guidance. For general questions, contact the OOC DBE lead.

Chapter 18 – Emergency Declaration Projects

1-1800 General

The Commissioner has the authority to issue an Emergency Declaration (ED) in accordance with Section 13b-26(f), and in limited cases Section 13b-4(d) of the Connecticut General Statutes.

An emergency is generally reserved for situations where all of the following conditions are met:

- Natural or human events have resulted in actual or potential imminent, serious public harm or disruption involving a highway or bridge;
- Responsible and timely response by the Department to the condition is not possible using routine business processes or resources;
- The Governor of Connecticut has not proclaimed a state of civil preparedness emergency for the condition.

A natural event is defined as a structural failure, rock slide, etc., which requires the Department, either through its own resources or contractual services, to take action by mobilizing the necessary resources as quickly as possible. Work should typically begin within 30 days if this involves the Department of Energy and Environmental Protection (DEEP). (Refer to Section 1-1804)

NOTE: FHWA funded “Emergency Relief” (ER) project will require direct coordination with FHWA’s Connecticut Division Office.

1-1801 Emergency Declaration Initiation Procedure (Office of Construction)

The recommendation to declare an emergency is brought to the attention of the Chief Engineer (CI), who will then discuss it with the Commissioner. If preliminary information indicates a likely threat to public safety or significant disruption related to a highway or bridge, the CI or their designee, will assign a Lead Engineer from the District Office with primary responsibility for carrying out these procedures. In some (e.g., large-scale, catastrophic) cases, the respective Bureau Chief will personally lead the evaluation and response effort.

If the CI determines that emergency procedures are needed to carry out the response, the respective Bureau Chief will assign staff to draft an ED using the current form and format, modified to describe the specific situation/conditions. Staff shall follow the [Emergency Declaration Procedures](#) to draft the ED.

The following is the ED Process for Construction Staff:

1. The Office of Construction (OOC) sets up an organizational meeting and subsequently, a field review with the appropriate and knowledgeable individuals in the Office of Engineering (OOE), OOC, District, and other offices that are involved in assisting in project delivery (Offices of Maintenance, Rights of Way, Finance and Administration, Bridge Safety, Environmental Planning and Environmental Compliance). Immediately following the site review, a meeting will occur to thoroughly discuss the scope of work and arrive at a method to proceed. At this time, a Concept Plan for finalizing the documents detailing the scope of work must be established identifying responsibilities and deadlines. All logistics and arrangements for progress copies of sketches and special provisions are to be sent directly to the District Engineer (DE).

- Generally, the emergency work should only include work necessary to abate the emergency and stabilize field conditions. If significant additional work is needed for full restoration, it should be accomplished through a subsequent, programmed project. The final decision on whether to proceed with full restoration will be made by the CI in consultation with the Engineering Administrator, Construction Administrator, respective design Division Chief, and respective DE.
2. The OOC and the Lead Engineer will assist the Engineering Office, and if applicable, the Office of Finance and Administration in the preparation of a [Recommended Project Memorandum \(RPM\)](#).
3. The OOC should obtain a project number and financial coding (if not already assigned) from the Office of Finance and Administration.
4. The District will review the historical ED contractor list provided by the OOC, select potential contractors for work and discuss with the Construction Administrator or Division Chief.
5. The Construction Administrator or Division Chief forwards the selected Contractor to the Chief Engineer for concurrence. The Construction Administrator or DE will contact the Contractor to determine if they are available to do the work. If unable or unavailable to do the work, step 2 is repeated.
6. The Construction Liaison with assistance from the Office of Contracts verifies that the selected contractor meets all the requirements for being awarded the work. Review the following examples: [Sample Contractor Verification Information](#) and [Template for Contractor Selection](#).
7. Prepare the [Emergency Work Letter of Agreement](#) for the approved Contractor.

The following documents are available from the Office of Contracts (Contracts) and must be attached to the Emergency Work Letter of Agreement (all originals and copies):

- Required Contract Provisions (classified by State or Federal funding)
- Governor's executive orders and guidelines
- Supplemental Specifications (if applicable)
- Special provisions prepared specific to the project by the Office of Engineering or others.

Utilities and railroads are sometimes impacted by emergency conditions. The Utilities Unit in the OOE will take the lead addressing and evaluating this work in conjunction with the District Utility Coordinators and the OOC.

- If work is required by a utility or railroad, it shall be expedited to the extent possible through the Utilities Unit.
- Reimbursement for authorized expenditures by utilities and railroads will generally follow the standard procedures except that the effective date will coincide with the Department's notification/request.

ED action may not allow time for the issuing of environmental permits or other environmental/historical approvals. However, regulatory agencies should always be notified of ongoing and impending emergency response activity that may affect an environmental regulated area or resource to avoid, minimize and mitigate regulatory impacts. For the large majority of emergency responses, the established emergency authorization procedures of State and Federal regulating agencies can be utilized. When time permits, obtain full environmental permits (via normal or emergency authorization permitting process) prior to undertaking regulated response activities. Further information and guidance can be found on the Office of Environmental Planning's [Water and Natural Resources webpage](#).

Table 1 – Emergency Agreement Process

EMERGENCY AWARDING	WHERE TO FIND INFORMATION
Affidavits checked online - handled by Contracts. Need login and admin to view. https://www.biznet.ct.gov/AccountMaint/Login.aspx	OPM forms filed with DAS http://www.ct.gov/opm/cwp/view.asp?a=2982&q=386038&opmNav_GID=1806
OSHA Certificate - handled by Contracts. Self-certified, submitted by Contractor	S:\const\OOC_Doc_File_Cabinet\EmergencyDecProject\ED_Forms “OSHA Contract.pdf”
Insurance - handled by Contracts	ACORD Contractor and State Liability Coverage
Secretary of State - handled by Contracts	Approved to conduct business in Connecticut and has “Active” status http://www.concord-sots.ct.gov/CONCORD/online?sn=InquiryServlet&eid=99
Workers' Compensation - handled by Contracts	State Treasurer sends letter to say Contractor’s not liable.
DMV - handled by Contracts	Send an email to DMV to check if Contractor has any safety violations. Needs to be done before selection of contractor
Affirmative Action expiration date – handled by Office of Construction (OOC)	Send email to Office of Contract Compliance
Debarred by CT DOL - handled by Contracts	http://www.ctdol.state.ct.us/wgwkstnd/wgdisbar.htm
Is Company Federally Debarred - handled by Contracts	https://www.sam.gov/portal/public/SAM/#1
Contractor in CORE - handled by Contracts	Check Vendor Name in CORE

EMERGENCY AWARDING	WHERE TO FIND INFORMATION
Complete Prevailing Wage Rates Request Form - handled by OOC	Send email to Holly.Carter@ct.gov Wage and Workplace Standards.
OSHA page - handled by Contracts. Check to see if Contractor has violations; law says they can't have more than 3 violations to be able to work	https://www.osha.gov/pls/imis/establishment.html ; print summary sheet and attach
Performance Bond - handled by Contracts. Signed by bonding agent at time of signing of letter of agreement or comes in beforehand to sign	http://www.ct.gov/dot/lib/dot/documents/dpurchasing/performance_bond_Construction.pdf
Payment Bond - handled by Office of Contracts. Signed by bonding agent at time of signing of letter of agreement or comes in beforehand to sign	http://www.ct.gov/dot/lib/dot/documents/dpurchasing/payment_bond.pdf
Complete information on " Recommended Project Memo (RPM) " for Division of Capital Services to initiate project and set up a budget. Handles by OOC	"Recommended Project Memo (RPM)"
Complete information on Contractor Selection Information for submission to Division Chief. Handled by OOC	"Template for Contractor Selection"
Attorney General Memo not required for routine contracts – Only complex or unique agreements sent to AG office with affidavits required under Integrity in State Contracting – handled by OOC	"AG memo with affidavits on biznet"
Obtain CORE contract number (i.e. 15dot0509aa) - handled by Contracts	Letter of Agreement sent to Contracts with information to get CORE contract number
Code and approve project into CORE - handled by Office of Fiscal Services	When Core ID is received from Contracts, forward to F&A

- The OOC will contact the Contractor and set a date and time for the award meeting. At this meeting the Emergency Work Letter of Agreement will be signed and the Contractor will provide the required Certificate of Insurance on ACORD Form and provide Performance and Payment Bonds. If an emergency arises after normal work hours, on weekends or a Holiday, and it is necessary to dispatch a contractor immediately to assure the safety of the public, the Liaison Engineer must initiate and attempt to process all necessary paperwork on the next work day. The Contractor should also have the Certificate of Insurance completed and submitted on that day. In no case will lack of paperwork delay the Contractor from starting the repair.
- The Construction Liaison will put together the Emergency Work Letter of Agreement (with attachments) and obtain the required signatures. The signed Agreement will be distributed as follows:
 - Copy to the Contractor
 - Copy to the Office of Construction
 - Copy to the District Office
- The Construction Liaison enters pertinent project information into the emergency project folder maintained within Construction Emergency Declaration Folder.
- The Construction Liaison will then send copies of all information to the District for project records.
- The Construction Liaison continues to provide support to the Lead Engineer, District, Contractor and the Office of Engineering until the project is completed.

1-1802 Emergency Declaration Project Administration

The District assigns a PE and Inspector(s) for the project. On issuance of the Emergency Work Letter of Agreement to the Contractor, the District coordinates all necessary meetings, utility notifications, maintenance of traffic schemes, etc.

The PE coordinates with Design on the status of the plans, design completion date, etc., and reports the information biweekly on the [Project Summary Report](#). Any issues with the progress of the work are noted, along with the anticipated completion date. A [sample Emergency Project Status Report](#) is available for guidance.

The PE completes and submits the Project Summary Report every two weeks to the Construction Liaison for review and distribution. The value of work completed should be estimated for each two-week period.

1-1803 Recordkeeping and Administration of Emergency Project

The District shall enter all required information into the SiteManager system and administer project in accordance with the requirements of the Construction Manual. (Refer to Volume 1 Chapter 3 “Record-keeping” for additional information on maintaining the project records). Contract time should be counted as “charged” each calendar day, if temperature sensitive material will be affected by winter, the time is still counted as “charged” through winter shutdown.

1-1804 Procedures Relating to DEEP Authorizations for Emergencies Declared by the Connecticut Department of Transportation Commissioner (February 2013)

****This document supersedes the April 18, 2012 version.***

Controlling Statutes and Current Department of Transportation Procedures:

Section 13b-26(f)(2) of the Connecticut General Statutes (CGS) authorizes the Commissioner of the Department of Transportation (Department) to declare "...that an emergency condition exists on any highway in the state which demands immediate attention to insure the safety of the traveling public..." The specific type of emergency will be dictated by the immediate impact to the safety of the traveling public. The two distinct categories, as identified in the Department's Construction Manual that an emergency may fall under are as follows:

- Immediate Repair - A natural disaster, structural failure, rock slide, etc., any of which require the Department, either through its own resources or contractual services, to take action by mobilizing the necessary resources as quickly as physically practical, very often within hours of the event. Work should typically begin within 30 days.
- Accelerated Repair - An emergency condition which demands immediate attention to insure the safety of the traveling public. The time needed to complete construction could be governed by the need for survey and design before commencement of construction of the project. These projects are typically handled like routine projects; however the schedule for design, advertising, award, and completion is greatly accelerated. Work should typically begin within 180 days.

Once an emergency situation has been declared by the Department Commissioner, section 22a-6k(a) of the CGS authorizes the Department of Energy and Environmental Protection (DEEP) to issue emergency authorizations for activities regulated under Stream Channel Encroachments, Water Diversions, Dam Construction, Tidal, and Inland Wetlands. An emergency authorization may be granted when DEEP finds that "...such authorization is necessary to prevent, abate, or mitigate an imminent threat to human health or the environment..." and that "such authorization is not inconsistent with the federal Water Pollution Control Act, the federal Rivers and Harbors Act, the federal Clean Air Act or the federal Resource Conservation and Recovery Act." Section February 2013

22a-363d authorizes DEEP to issue emergency coastal permits in situations which may result in "...immediate, unforeseen and unacceptable hazards to life, health or welfare or significant loss of property if corrective action...is not undertaken..." Section 22a-6k(b) of the CGS authorizes the DEEP to issue temporary authorizations for certain activities regulated under general permits for Tidal (Structures, Dredging and Fill and Minor Activities), and Dam and Reservoirs (Minor Activities). A temporary authorization may be granted when DEEP finds that "...such activity will not continue for more than thirty days..." and that "such authorization is not inconsistent with the federal Water Pollution Control Act, the federal Rivers and Harbors Act, the federal Clean Air Act or the federal Resource Conservation and Recovery Act." "No temporary authorization shall be renewed more than once, and no such authorization shall be issued for an activity which has been authorized by a temporary authorization during the previous twelve months." Such emergency and temporary authorizations shall be limited by any conditions that Commissioner of DEEP deems necessary to adequately protect human health and the environment.

Procedures to Determine Appropriate Regulatory Authorization

Immediately upon discovery of any emergency situation the initiating office must call for an Emergency Determination Meeting (EDM). The purpose of which is to evaluate the impact on the safety of the traveling public, to determine the speed with which action must be taken, to evaluate the level of repair, and to determine permitting requirements. No work shall be performed to temporarily stabilize or repair a location until this meeting has been held.

A Point of Contact (POC) list shall be developed and updated as necessary to ensure that Department personnel with the ability to make pertinent decisions are present for any EDM. This list shall include methods for after hour's contact of the appropriate personnel. At a minimum a member of Maintenance, Environmental Planning, Construction, and Design must be present at any EDM. A separate POC list must be developed for each Maintenance District and updated as necessary to ensure that all Maintenance personnel are aware of the proper contacts and procedures during an emergency situation. February 2013

Emergency Concept Plan Response and Execution

The Department's Office of Environmental Planning (OEP) will be the lead office for any coordination with DEEP that may be required for emergency actions. When an emergency situation arises, the following procedures must be followed.

As soon as any such emergency situations become known by a Department operating unit, that Department operating unit must notify a member of OEP. Once an EDM has been set up, the appropriate member of OEP will attend. Unless an immediate threat to public safety exists, no work will be performed on any emergency situation unless a member of OEP has been contacted. An emergency declaration by the Department Commissioner does not mean that the project does not require state and federal permits for impacts to regulated areas.

Upon learning of an emergency situation, OEP will perform a preliminary environmental assessment of the location and determine the appropriate contact at DEEP. OEP management will contact DEEP management to discuss scheduling and staffing requirements. A staff member from OEP will be assigned to coordinate between DEEP staff and the other Department operational units involved in the emergency repair. In order to facilitate rapid coordination and transmission of documents, all communication within the Department and between OEP and DEEP, including permit applications and approvals, shall be performed electronically by phone, fax, or e-mail. Paper copies of the appropriate submittals and approvals will follow once the immediate nature of the emergency has been alleviated.

In recognition of the truncated schedule required on emergency projects, the level of detail associated with the permit application and design plans is less than that submitted under normal conditions. The application for emergency authorization shall contain sufficient information to initiate a DEEP review and at a minimum include a location plan, an executive summary describing the work that will be performed, and a sketch drawing showing the nature of the repair work and the aerial impacts to any regulated locations. Emergency work will be limited to alleviating any threat to the safety of the traveling public and stabilizing the site to prevent further environmental impacts. February 2013

As much information as possible should be provided to OEP to facilitate approval from the appropriate DEEP office. Immediate emergencies, action is necessary to stabilize the site, an Emergency Authorization from DEEP will be obtained. Following alleviation of any immediate danger, a full permit application will be submitted to DEEP. Regulated work, outside of emergency conditions, shall not be performed without a permit approval or emergency authorization in place, unless no other option exists to protect public safety. The initiating office shall be responsible for ensuring that all appropriate permits are in place prior to beginning work.

If advised by the DEEP that a permit is required for any portion of an emergency action, the Department will provide, at a minimum, all of the following:

- A narrative identifying the emergency and the scope of anticipated corrective actions.
- A time frame for when the work will begin and how long it will take to complete.
- A preliminary plan drawing for such actions, including a depiction of the extent of work to take place in wetlands or watercourses. Details of the aerial impact will be given in square feet and amount of material in cubic yards.
- Any hydraulic assumptions or analyses conducted.
- The plan should be specific on the type of interim sedimentation controls and permanent stabilization to be used.

- Specific construction practices and mitigation measures to be implemented in carrying out the corrective actions will be identified through the DEEP coordination process.

The Department unit tasked with performing the emergency repairs will submit the above items and a copy of the Department's emergency declaration to OEP. Any application to DEEP for regulated activities must be completed using the best information and plans available at the time of its preparation. The application will be expeditiously processed by DEEP with the intent of issuing an appropriately conditioned permit authorizing the emergency work. If approved, the emergency authorization will contain specific terms and conditions including an expiration date. A notice of the permit application must be published in accordance with CGS Section 22a-6g. No newspaper notice is required if the activity is covered under IWRD's General Permit, but February 2013.

Widespread Weather Related Repairs Not Declared an Emergency by the Commissioner

In certain situations, severe weather conditions may cause widespread damage to the Department's transportation systems but not warrant an emergency declaration by the Commissioner. When this scenario occurs, special procedures must be implemented to ensure that no work occurs outside of what the Department is authorized to perform under the General Maintenance Permit. Any work that needs to occur in or adjacent to a regulated area must be coordinate with the District Drainage Engineer prior to being started. Each Maintenance Garage shall have a POC list which dictates who must be contacted in the event that storm related damage is discovered. No work shall be performed until the District Drainage Engineer has been contacted and has approved the repair.

The District Drainage Engineer will be responsible for developing a site list and determining whether the required activities can be covered under the Drainage Maintenance Permit. When the scope of proposed work exceeds the limits set in the Drainage Maintenance Permit than the District Drainage Engineer must coordinate with OEP to obtain the appropriate authorization prior to starting any regulated repair work. OEP will work with DEEP to obtain a blanket temporary authorization to perform storm repairs.

When storm repairs are required, the Drainage Engineer will be responsible for obtaining before and after pictures at each work site, aerial impact quantities for any repair work in a regulated area, and the work start and work completion dates. By no later than thirty (30) days following the storm event the District Drainage Engineer will provide this information to OEP.

Notification letters to the town agencies are necessary as outlined under the CGS section regarding the General Permit.

An Army Corps of Engineers (ACOE) Permit may also be required if the impact exceeds 5000 square feet to an inland wetland location or in any coastal location and, if so, OEP will need to provide an ACOE category determination.

Chapter 19 - Insurance and Bond Requirements

1-1901 Insurance Requirements

The Contract requires Contractors to carry insurance at least in accordance with the requirements stipulated therein. As outlined in the Department's Construction Contract Bidding and Award Manual, the Contractor must submit evidence of insurance by completing the insurance industry Association for Operation Research and Development (ACORD) Certificate of Liability Insurance form prior to contract award.

The following are guidelines for enforcing and administering the requirements in the Contract for contractors to carry insurance. The designated District staff must do the following:

- Ensure the evidence of insurance conforms to the specified requirements.
- Ensure the Contractor's required insurance does not lapse during the life of the project.
- Forward a copy of any revised evidence of insurance received for renewal or changes in coverage to DOT Contracts Section.
- Verbally request new Certificate of Insurance 30 days in advance of the expiration date of any coverage.
- If the contractor fails to provide evidence of insurance coverage by the expiration date, request the Contractor to immediately obtain the necessary coverage. A [sample letter requesting evidence of insurance](#) can be found in ProjectWise within the 04.1 – Construction Libraries > 04.100 – Manuals, Guides and Training Videos folder.
- If the above procedure does not result in obtaining evidence of coverage, contact the Office of Construction for guidance.

1-1902 Performance Bonds

Under the terms of performance bonds issued for CONNDOT projects, the bond remains valid as long as the Contract is not increased or decreased by more than twenty-five percent of the original contract value. In order to ensure that the state is afforded full protection under the performance bond, a new bond must be issued whenever the contract value increases or decreases more than twenty-five (25) percent beyond the value listed on the current bond.

During the Construction Order process, the District must determine whether approval of the Construction Order will trigger the need for a revised performance bond. When the contract value increases or decreases more than twenty-five percent of the original (or revised) bond value, the Contractor and surety should be notified that a new bond is required. The notice is to require submission of a new bond within fourteen (14) days of the date of the notice. The Contractor and surety must submit the bond to the Office of Contracts in the same manner that the original bond is submitted and executed. If the new bond is not received within 14 days of the original notice a second notice should be sent by a method that documents delivery, i.e. UPS ground service or Certified Mail – Return Receipt. A [sample letter requesting a new performance bond](#) can be found in ProjectWise within the 04.1 – Construction Libraries > 04.100 – Manuals, Guides and Training Videos folder.

On a quarterly basis, the District will provide the Contracts Section and Office of Construction with a list of projects that had new bonds issued during the reporting period.

Chapter 20 – Maintenance and Protection of Traffic (M&PT) Changes and Public Relations

1-2000 General

This Chapter describes the Office of Construction's (OOC) procedures for administering contract provisions for maintenance and protection of traffic ("M&PT") and press releases, including any contract revisions based on field conditions and operations.

It should be noted, some larger projects designated as "significant projects" have a Transportation Management Plan (TMP) as part of the project documents. This plan is designed to accommodate the traffic of the entire region and is to be followed as closely as possible. The FHWA's Work Zone Safety and Mobility Rule is discussed in Section 1-2002 and includes a definition of significant projects.

1-2001 Procedures for Revising Contract Provisions for M&PT

Sections 1-2001A through 1-2001C describe the procedures to follow for revising Contract provisions for the Traffic Management Plan (if applicable), Maintenance and Protection of Traffic, Limitation of Operations and Prosecution and Progress, and emergency situations.

1-2001A Case 1 – Revision to the Transportation Management Plan (TMP) or M&PT Plan

Revisions to the traffic control plan or project staging requires concurrence from both the OOC and Office of Engineering (OOE). Revised construction staging sequences or limits, detours and ramp closures are considered to be revisions to the traffic control plan. Before the proposal is forwarded to the OOC and OOE, the District must evaluate the proposal to ascertain if it will benefit the State, in terms of time or money. Revisions proposed by the Contractor should be evaluated for potential credit due the state. After evaluation by the District, the proposal is transmitted by a memorandum from the Assistant District Engineer (ADE) or District Engineer (DE) to the Construction Division Chief or the Construction Administrator for approval. If approved, the District should notify the Division of Highway Operations. The memorandum must include:

- Details of the proposed revision in the form of sketches or narrative. Any ramp closures should be reviewed in accordance with Section 1-2002A.
- The reason for the proposed revision.
- The exact location with stations and the anticipated duration the revision will be in effect.
- The impacts of the revisions on:
 1. Condition of the roadway (examples are: reduced shoulder or lane width, traffic shifted temporarily on shoulders, barrier on both sides with no shoulders, revised cross-slope),
 2. Neighborhoods affected by the proposed change or the community at large (examples are: ramp or road closure that may affect residential, business access or emergency responders), and
 3. Contract provisions (calendar day allowance, liquidated damage clauses, completion schedules, prosecution and progress).
- The mitigating measures proposed (examples: paving the shoulders, additional drainage, additional signing and delineation, temporary pavement to improve the cross-slopes, etc.).

- Proposed detour and the signing/marketing plan that shows the M&PT traffic devices and proposed locations of trafficpersons to assist in traffic control.
- Written concurrence from City/Town for detours utilizing roads other than State Highways or impacting the traffic flow in the local community.
- Approximate cost of the revision and the potential benefits to the State. If the Contractor initiated the request, generally it should be at no additional cost to the State including any costs for physical work, traffic control items and traffic persons.
- The deadline for implementing the revisions beyond which the stated benefits may not materialize.
- The District's recommendation on the proposed revision.
- Draft Press Release

If it is determined to go forward with the proposed revision, the Designer may prepare a construction order to the Contract and issue the revised construction sequencing and staging plans and Special Provisions by a memorandum to the District. The District may direct the Contractor to proceed with the revision with the concurrence of both the OOC and OOE before the final construction order is issued. Appropriate press releases must be issued if not already in place, see Subsection 1-2003.

Exceptions to Traffic Staging to be processed as Case 2:

- Transition stage and traffic shifts involved in proceeding directly from one planned contract stage to the other.
- Revisions to the traffic staging that do not involve reduction in lane or shoulder widths, lane configuration or alignments, and elimination of barrier runs.
- Permitting work shown in one stage to be performed in another stage as long as proposed stage revision does not adversely impact traffic during current and future stages.

1-2001B Case 2 – Revision to Limitation of Operations

Case 2 scenarios are revisions to the Limitation of Operations and Prosecution and Progress Provisions of the Contract. Any revision proposed by the Contractor must be evaluated by the District to ascertain if it has merit and determine if a credit due the state is warranted. The revision should also receive concurrence from the Division of Traffic.

A memorandum from the ADE or DE is sent to Construction Division Chief informing of the District's approval. This memorandum is to have attached to it a completed Case 2 Backup Documentation Form, shown in Figure 1-20.1. The memorandum must also be submitted well in advance of the proposed revision and, when appropriate, a revised press release issued. For information on press releases see Subsection 1-2003.

If significant impacts to traffic operations are anticipated due to the revised limit of operations, the District will advise OOC at least seven days before the proposed change is implemented.

1-2001C Case 3 – Emergency Operations

When Contract operations of emergency nature are required to be performed, such as hazardous pothole patching, cleaning up damaged sand barrels, repairing damaged bridge joints, etc., the Chief Inspector (CI)/Project Engineer (PE) will request authorization to perform the necessary repairs from the ADE or DE. However, if the emergency work necessary is an immediate hazard to the traveling public, the PE has the authority to proceed as required. Otherwise, the ADE/DE will direct the appropriate course of action to the CI/PE. If the condition does not pose an imminent safety hazard, the repair work should be performed within the allowable hours for lane closures.

The CI/PE will be responsible for notifying the Operations Center and OOC of the proposed work. The field inspectors are responsible for notifying the Operations Center at the completion of the emergency work.

Figure 1-20.1 Case 2 Backup Documentation Form

Procedure for evaluating the revisions to the Limitation of Operations and Prosecution and Progress:

1. Complete description of the proposed revision.
2. The location, time of occurrence and the duration of the work.
3. The reason for the proposed revision.
4. Benefits of the revisions and the ramifications of not allowing the revisions.

Recommendation:

Recommended: _____ Approved: _____
Project Engineer Assist Dist. Engr./Dist. Engr.

Attach supporting documents

- Pertinent specification highlighting the appropriate articles where changes are being proposed.
- Hourly traffic volumes.
- Comments and/or recommendation from the Division of Traffic.
- Proposed detour and the signing/marketing plan that shows the M&PT traffic devices and proposed locations of trafficpersons to assist in traffic control
- Written concurrence from City/Town for detours utilizing roads other than State Highways or impacting the traffic flow in the local community.

1-2002 Work Zone Safety and Mobility

The Work Zone Safety and Mobility (WZS&M) policy systematically considers and manages work zone impacts of significant projects. This provides a high level of safety for both workers and the public. It also minimizes congestion and community impacts as well as provides both field forces and Contractors adequate access to the highway to efficiently conduct their work.

In order to provide timely notification to motorists, ANY lane closures on ANY limited access highways are to be called into the appropriate Operations Center BEFORE interfering with traffic to install patterns and then again when patterns are removed. A map delineating towns assigned to the Newington (NOC) or Bridgeport (BOC) Operation Centers and the call in numbers are in Chapter 14 Subsection 1-1409.

When the field staff calls into the NOC or BOC, depending on the area they are working, they should be providing the minimum information in accordance with Subsection 1-1409.

In order to meet the Department's objectives on projects of "significance", appropriate planning, design, construction, maintenance and public awareness strategies shall be employed on all significant projects. For the purposes of this policy, a significant project is defined as:

"A stationary highway construction or maintenance activity which causes sustained mobility impact on I-84, I-91, I-95, I-691, I-291, or I-384 for more than 3 days with either intermittent or continuous lane closures. In addition, any highway construction or maintenance activity that alone or in combination with other concurrent activities nearby, which is expected based on engineering judgment, to cause sustained mobility impacts that are considered greater than what is considered tolerable relative to typical traffic operations experienced in the area of the work zone, may be declared a significant project".

It is recognized that the Department's emergency operations may not always allow a systematic consideration of work zone impacts. In such situations, the objectives of this policy will be honored as much as practicable.

Construction project staff will monitor their work zones and make appropriate adjustments based on their observations of accidents and traffic operations. On active projects, construction project staff and the Contractor shall each designate a person to properly implement the Transportation Management Plan (TMP). In addition to the Inspection of Temporary Traffic Control (TTC) and the Transportation Operation (TO) components of the TMP, construction project staff will take the lead in the coordination and implementation of Public Information/Public Outreach (PI/PO) strategies. Refer to the *Public Information & Public Outreach Guide for Significant Construction Projects* which can be found with the Approved Forms located in ProjectWise.

(Documents - 04.1 - Construction Libraries - 04.200 - Approved Forms and Inspection Checklists)

Construction staff will monitor and collect data on work zone incidents for the purpose of identifying problematic trends and implementing appropriate adjustments.

1-2002A Ramp Closures

During the course of contract work it may become necessary to temporarily close certain exit and entrance ramps to accommodate safe efficient construction operations, as well as, for the safety of the motoring public.

It is up to the assigned field staff for a project to review all existing ramp widths prior to construction operations. In the consideration of a temporary ramp closure, project and District Staff should review the following guidance chart. If it is deemed a ramp should be closed on a temporary or extended period of time, during active construction, the Inspector should notify the Project Engineer.

The PE should contact the Office of Traffic Engineering to inquire about the proper detour route. Once confirmation has been received a Case 1 revision may proceed in accordance with Section 1-2001A above.

Figure 1-20.2 Ramp Closure Guidance Chart

Location/Operation Description	Existing Width Less Than	Closure Recommended During Active Construction	Only Times Staged Construction is Recommended?
Milling & Paving	30'	Yes	Not Recommended even temporarily due to equipment width requirements
Ramp Reconstruction:			
Roadway	30'	Yes	Yes for widths in excess of 30', however, will require ramp closures for the installation and removal of TPCBC
Bridge	30'	Yes	Yes for widths in excess of 30', however, will require ramp closures for the installation and removal of TPCBC
Guiderail/Parapet Reconstruction:			
In season work	25'	Yes	Yes, for widths in excess of 25'
Through Winter	27'	Yes	Yes, for widths in excess of 27' on a tangent to accommodate maintenance
IMS/Electrical/Illumination	21'	Yes	Yes, only for temporary patterns
OH and Side Mounted Sign Installations	21'	Yes	Yes, only for temporary patterns where the width is in excess of 21'. Periodic closures for sign and structural element installation will be required.

The above noted widths are based on ramps on a tangent or gentle horizontal curves. Anything having a curve less than R= 900' should be reviewed on a case by case basis for tractor trailer movements.

1-2003 Press Release Procedures

The Department provides press release information for current and planned maintenance and construction activities.

To efficiently process press releases, the following routing procedure has been developed to:

- Promote linear routing of press releases from the project to the Office of Communications.
- Permit electronic transmittal wherever possible.
- Task the managers and administrators with review and approval only as necessary.
- Differentiate between “Routine” (Contract Compliant) and “Special” (Contract Change) events.

The OOC District Liaisons are the primary Headquarter recipients for District generated press releases.

For routine contract compliant events, the Final Copy Press Release from the project staff or consultant is transmitted through the PE to the District Liaison who will forward it to the Office of Communications. District Managers in Construction and Maintenance are to receive a copy for information only.

For significant events, such as a limited access highway closure or an extended ramp closure, there should be enhanced attention by the District in developing the Press Release. The DE or the ADE should review the Press Release and forward to the District Liaison and the Construction Division Chief at least three weeks prior to the event to ensure appropriate public outreach.

It is required that a press release be in a complete and finished form when it is sent to the District Liaison. Incomplete press releases or outdated (late) ones will be returned for revision. E-mail is the preferred method of transmittal.

1-2004 Public Relations on the Job Site

If for any reason, a member of the press contacts the field staff or comes to the job site, the project personnel are to direct them to the Department's Office of Communications (860) 594-3062. The PE should be notified as soon as possible if members of the media contact the field office.

If the project personnel are contacted by elected officials or anyone who holds statewide office, they should be directed to speak to a TSE or TE-3 and/or the Department's Legislative Program Manager. All contacts, concerns or discussions should be documented on the DWR and the PE should be notified.

Project personnel should deal directly with property owners, business owners, public works officials, town employees and utility companies to the extent of their project involvement and within the limits of their authority. Any questions or discussions should be brought to the PE's attention.

If the project is utilizing weekend or full week road closures to expedite construction under the Department's Accelerated Bridge Construction Program it may be beneficial to coordinate with the local municipality and use their reverse 911 system to "get the word out."

1-2004A Pedestrian Access - Americans with Disabilities Act

All Maintenance and Protection of Traffic (M&PT) plans should be reviewed by project staff prior to the start of the project to ensure that accessibility accommodations for all users of the roadway are met. Accessibility must be maintained during all stages of construction and throughout the project. The M&PT plans and Section 9.71 of the *Standard Specifications* must include provisions for movement of pedestrian traffic through a work zone in a safe and efficient manner. It is the Contractor's responsibility to maintain the pedestrian access during all stages of construction. Pedestrian traffic includes but is not limited to pedestrians, bicyclists and disabled individuals. It may include temporary sidewalks, barrier, safety fencing, lighting, signalization and line striping. It is also recommended that this is discussed with the Contractor at the Pre-Construction Meeting.

At times the M&PT plans may not adequately address all aspects of construction operations. Such conditions should be anticipated and the inspection team, in collaboration with the Contractor should develop traffic control plans for the particular phase or activity to address these concerns. Any plan revisions should be reviewed with the Division of Traffic.

Minimally, the level of accessibility for pedestrian traffic that was experienced prior to the project should be provided during construction operations. In instances where it is impractical to maintain such access during a phase of construction, alternate access should be provided. In particular, if access for the disabled

cannot be provided through the work zone during construction, then alternate arrangements around the work zone must be provided.

Pedestrian access should be monitored daily by the Inspector and if the Contractor is not in compliance, action should be taken to correct the situation as soon as it is possible. If necessary a Non-Compliance Notice form shall be issued to the Contractor to correct the situation.

1-2005 Trafficperson & State Police

State Police Services procedures can be found with the Approved Forms located in ProjectWise. (Documents - 04.1 - Construction Libraries - 04.200 - Approved Forms and Inspection Checklists)

Field Personnel are to review the Trafficperson and Maintenance and Protection of Traffic specifications for procedures pertaining to the use of Trafficpersons and/or State Police Officers within the Work Zone.

The following are general guidelines.

- Before the start of operations requiring use of Trafficpersons and/or State Police, a meeting is scheduled with all parties to discuss the Trafficperson/State Police operations, lines of responsibility and operating guidelines which will be used on the project.
- An Inspector is designated on every contract the responsibility to ensure proper payment of the Trafficperson and/or State Police invoices. The duties of this individual will include the review of sign-in sheets to ensure accuracy and prevent overlapping of the work hours when services are moved from one duty station to another or from one project to another.
- The payment is in accordance with the specification and established procedures.

Note: The Trafficperson item will be used as payment for services provided by the Contractor, or Municipal police. Reimbursement for State Police will be by invoice between the Department of Transportation and the Department of Emergency Services and Public Protection (DESPP).

1-2005A Municipal Police Officers and Uniformed Flaggers

When Municipal Police Officers are used and surcharges are included on the invoice, the project staff shall ask the Contractor to provide a letter from the agency, documenting the rates and surcharges, if any, that are regularly charged for their police and police vehicle services. This should be requested at the initial meeting discussing Trafficperson operations. A copy of this letter must be kept in the Volume III with the monthly statements or receipted bills.

The monthly statements or receipted bills for Municipal Police Officers are kept in the Volume III. If the statements or bills are not itemized with the Municipal Police Officers' names, hours, dates, police vehicle, etc., a revised statement or bill that is detailed should be requested.

The DWRs record daily services of trafficpersons. It is recommended that the trafficperson information is entered in SiteManager. A zero quantity may be used to enter information for Municipal Police Officers. The following information should be included in the remarks section:

- Name of Municipality/company providing trafficperson, i.e. (name of Municipality) Police, contractor's workforce or subcontractor, (in SiteManager, when a subcontractor performs the service with their workforce, associate the work item with the subcontractor, and only show the name and hours of employee in the remarks).
- Name of Trafficperson.
- Badge number, if law enforcement officer.
- Hours worked.

- Lunch or no lunch period.
- Hours of police vehicle service, if appropriate.
- Duty station and function performed.

Sample:

1. Municipal Police Officer
 Coventry Police
 Doe #55, 1000-1800, 0.5 hr lunch
 Closed high speed lane 00+15 to 00+25
 Police vehicle, 7.5 hrs.
 Intersection of Swamp Rd. and Rte. 44
2. Contractor/Subcontractor
 John Smith, 1000-1500, no lunch
 Closed breakdown lane Rte. 68
3. For State Police: Information entered into the DWR Trafficperson Remarks Section
 Doe #55, 1000-1800, 0.5 hr lunch
 Closed high speed lane 00+15 to 00+25
 Police vehicle, 7.5 hrs.
 Intersection of Swamp Rd. and Rte. 44

Before payment of the Trafficperson (Municipal Police Officer) item is made, the officers listed on the DWRs are compared against the monthly statement or receipted bills from the Municipality that actually provided the service. For projects using SiteManager, a summary of the Trafficperson (Municipal Police Officer) item entries on all project DWRs can be created by running a DWR Work Item Detail report in the SiteManager Reporting program.

The DWR Work Item report is used for the initial review of statements or receipted bills. If a discrepancy exists between the entries and the statement or receipted bills, it must be fully investigated and a determination made by the Inspector as to the validity of the payment. The reasons for payments made, for which there were discrepancies, must be fully documented on the DWR. In addition, it is encouraged to maintain a list of trafficpersons used on the project in the Volume III with the monthly statements or receipted bills in order to facilitate the proper payment for services rendered. On projects that do not use SiteManager, this list is mandatory.

If the number of trafficpersons ordered by the Contractor on the project exceeds the number approved by the Inspector, the Inspector will review the need for extra personnel in accordance with the contract documents and specific field conditions. If it is determined that the Contractor ordered the trafficpersons for their own use, those costs will be deducted from the trafficpersons item payments.

The Contractor's log should not be used as the source for payment of the trafficpersons. The payment for trafficpersons must be made under the appropriate item. There is no need to create a new item changing the unit of measure from "Estimated Cost." When necessary the quantity is increased by Construction Order.

Separate payments are made for each Municipal law enforcement agency providing trafficperson services. Each payment should be clearly labeled on the DWR with the respective agency for which the payment is being made. This is important because various administrative reports are dependent upon this information being clearly labeled.

1-2005B State Police

Reimbursement for State Police will be by Invoice between the Department of Transportation and the DESPP in accordance with the Memorandum of Understanding.

1-2005B-1 Ordering of State Police Services for Highway Construction Projects (HCP) Procedures

State Police Services procedures can be found with the Approved Forms located in ProjectWise. (Documents - 04.1 - Construction Libraries - 04.200 - Approved Forms and Inspection Checklists)

- Section I – Funding State Police Services.
- Section II – Ordering and Processing.
- Section III – Contacts for DOT and DESPP

1-2005B-2 Project Close Out

The DESPP will have 90 days to close out billing for any particular project. To trigger this 90 day “clock”, the OOC sends DESPP a copy of the project’s CON-500 form.

1-2006 Barricade Warning Lights

Use the following recordkeeping guidelines for Barricade Warning Lights. Barricade Warning Lights must be listed initially, with locations, on a DWR, then noted on a DWR only when a change in the count occurs. Payments may be made daily, weekly or monthly.

1-2007 Opening to Traffic or Occupancy Including Stage Shifts

The Inspector should record all stage shifts and final alignment on the DWR. On Interstate or limited access highways projects, the ADE must notify the Construction Division Chief or the Construction Administrator of the opening date. Depending on the scope of the Contract, multiple notifications may be required.

On occasion, the Department and/or other interested agencies/parties want to publicize the opening of a transportation facility to the public. When it is anticipated that a transportation facility, or major portion thereof, will be opened to the public, the District should notify the OOC Liaison Engineer at least 14 days prior to the anticipated opening. Examples of events requiring notification include opening of:

- New or reconstructed roadways.
- Additional travel lanes or new operational lanes.
- Completed structures.
- Facilities reopened after emergency events.
- Opening parking, rail or other transportation facilities.
- New or reopened highway ramp.

Notification should be as far in advance as possible preferably two weeks ahead of the tentative opening date, so that arrangements can be made with the Director of Communications, the FHWA and other interested agencies regarding ceremonies for the opening.

For roadways and bridges, all traffic-control devices must be in place prior to the scheduled opening date – all safety devices installed, all pavement markings in place, and all temporary and permanent signs erected. For other transportation facilities, the facility must be ready and approved for occupancy. If for any reason this work cannot be completed prior to the scheduled opening, the District Office and the OOC Liaison Engineer must be notified immediately and advised of the revised opening date.

1-2008 Rolling Road Block Procedures

The procedures for installing and removing temporary lane closures using Rolling Road Blocks have been coordinated with the Connecticut Road Builders Association and the Connecticut State Police. These procedures continue to allow for Rolling Road Blocks, but place limitations on their use as well as providing for a pre-warning vehicle in advance of the sign pattern installation.

The Rolling Road Block procedure should be implemented on all projects which include the installation of temporary lane closures on limited access highways. It is recommended that a coordination meeting be convened by the project staff prior to implementing these procedures for the first time.

Implementing the procedures on individual projects will not require a construction order, as the procedures fall within the parameters of the existing specifications for Maintenance and Protection of Traffic. If not included in the original contract, a construction order will be required for the Pre-warning vehicle – a truck- or trailer-mounted attenuator vehicle with a variable message board mounted to the back, rather than a flashing arrow.

The procedure allows some discretion to District offices, therefore project-specific concerns should be reviewed with District management.

1. Temporary road closures using Rolling Road Blocks (RRB) will be allowed on limited access highways for operations associated with the installation and removal of temporary lane closures. RRB will be allowed for the installation and removal of lead signs and lane tapers only. The maximum duration of a RRB shall be limited to 15 minutes.
2. RRB may not start prior to the time allowed in the contract Limitations of Operation for sign pattern installation. Sign pattern removal must be complete prior to the time indicated in the Limitations of Operation for restoring the lanes to traffic.
3. On limited access highways with 4 lanes or more, a RRB may not start until the Limitations of Operation Chart allows a 2 lane closure. In areas with good sight lines and full shoulders, opposite side lead signs should be installed in a separate operation.
4. Truck-Mounted Attenuators (TMAs) equipped with arrow boards shall be used to slow traffic to implement the RRB. State Police Officers in marked vehicles may be used to support the implementation of the RRB. The RRB will start by having all vehicles (TMAs and police vehicles) leave the shoulder or on-ramp and accelerate to normal roadway speeds in each lane, then the vehicles will position themselves side by side and decelerate to the RRB speed on the highway.
5. Pre-warning Vehicle (PWV): An additional TMA equipped with a Portable Changeable Message Sign will be used to advise motorists that sign pattern installation / removal is underway. The PWV will be stationed ½ mile ahead of traffic queue.
6. The RRB duration shall not exceed 15 minutes from start of the traffic block until all lanes are opened as designated in the Limitation of Operation chart. If the RRB duration exceeds 15 minutes on 2 successive shifts, no further RRB will be allowed until the Contractor obtains approval for a revised installation procedure from the respective construction District.
7. RRB will not be used to expand a lane closure pattern to an additional lane during the shift. The workers and equipment required to implement the additional lane closure should be staged from within the closed lane. Attenuator trucks (and State Police if available) should be used to protect the workers installing the taper in the additional lane.

- 8. Exceptions to these work procedures may be submitted to the District Office for consideration. A minimum of 2 business days should be allowed for review and approval by the District.
- 9. The RRB procedures (including any approved exceptions) will be reviewed and discussed by the inspection team and the Contractor in advance of the work. The implementation of the agreed-upon plan will be reviewed with the State Police during the Work Zone Safety meeting held before each shift involving temporary lane closures. If the State Police determine that alternative procedures should be implemented for traffic control during the work shift, the Department and Contractor will attempt to resolve any discrepancies with the duty sergeant of the Troop. If the discrepancies are not resolved prior to the start of the shift, the work will proceed as recommended by the Trooper (within reason). Any unresolved issues will be addressed the following day.

1-2008A Rolling Road Block Additional Information

Inspectors should notify Highway Operations before and after the Rolling Road Block is in place.

Advance Warning Messages

Pre-Warning Vehicle (PWV): A TMA equipped with a PCMS and flashing lights should be located a half mile behind the Rolling Road Block operation. The purpose of this vehicle is to alert traffic to the slowed traffic ahead. In addition, if a queue forms, the back end of which is beyond the location of the PWV, a trooper can assist the PWV to back down the shoulder to warn oncoming traffic of the queue ahead.

The suggested PWV-PCMS should display:

- Frame 1:** SLOWED TRAFFIC AHEAD
- Frame 2:** BE PREPARED TO STOP

OR

- Frame 1:** STOPPED TRAFFIC AHEAD
- Frame 2:** BE PREPARED TO STOP

OR

A combination of messages stated above.

Chapter 21 - Municipal Systems Oversight

1-2100 General

A Municipal Systems Action Team (MSAT) is in each District. The primary function of each MSAT is to oversee all Municipal administered projects from the beginning to the completion. The Teams generally consist of one Transportation Engineer 3 (the Team Leader) and additional staff to handle all the duties and responsibilities as outlined in this chapter. The MSATs are the representatives for the Department. They will conduct the oversight of the municipal projects in a thorough and professional manner. For a general description of municipal requirements refer to the latest version of the Department's Municipal Manual.

For monitoring of all Civil Rights requirements, it is important to obtain additional instruction from Volume I Chapter 12, "Civil Rights."

1-2101 MSAT Responsibilities

- Oversee all District projects administered by municipalities.
- Attend the preliminary meeting with the project Municipal Administrator (MA) prior to the start of the project and explain the Municipality's responsibilities.
- Perform Design/Constructability Plan Reviews of municipal designed projects.
- Attend monthly Progress meetings and project Site Record Review meetings.
- Monitor municipal conformance with Federal and Department requirements. Provide assistance when warranted.
- Review and approve construction orders for eligibility. Request amendment of federal aid agreement when necessary.
- Review and approve time extensions or decisions not to enforce liquidated damages.
- Prepare Record Review reports. Review project records, as needed.
- Review, evaluate and process Invoice Summary and Processing (ISP) submission for reimbursement of municipal payments to the Contractor.
- Meet regularly with the MA to review project status, MA's responsibilities and any project issues that require attention.
- Attend semi-final inspection
- Notify Supervising Engineer when the Project is ready for Final Inspection
- Perform a Final Review of the project records. Send a copy of the Final Review to the Office of Construction (OOC) Quality Assurance Section. Return the records to the Municipality, if necessary, to correct any deficiencies or omissions. Forward a memorandum to the District Engineer or the Assistant District Engineer and the OOC Quality Assurance Section noting how the corrections were addressed.
- Prepare and submit Finals Package.

1-2102 Design/Constructability Reviews

A field review of the site should be performed, whenever possible. The following items/issues should be reviewed

- Major pay items
- Construction staging
- Available site access
- Appropriate rights of way
- Maintenance and Protection of Traffic

- Environmental issues
- Special provision items
- Potential Utility conflicts

Ensure that the Specifications that govern the contract are clearly identified such as *Standard Specifications*, Supplemental Specifications or Municipal Specifications and that they do not conflict with federal and or state required contract provisions.

1-2103 Preliminary Meeting with the Municipality for Municipal Responsibilities

Once the District is notified that a project has been awarded and a preconstruction meeting is scheduled, the Municipality is contacted by MSAT to set up a preliminary meeting. The Inspection Consultant should attend, if applicable.

If plans have not been received at the District, the Design Project Manager or the Municipality is contacted and arrangements are made to secure the plans and the contract.

Prior to the meeting, the MSAT Leader should review the Inspection staff for the project. If the proposed inspection staff hasn't been submitted for review, contact the Design Project Manager and Municipality to secure names and resumes.

In addition, the District MSAT should perform the following before the meeting:

- Review the Agreement between the Department and the Municipality.
- Review the Agreement between the Municipality and Consultant (if applicable).
- Review the plans and contract specifications.
- Perform a field review of the project.

The [Municipal Projects Preliminary Meeting Checklist](#) is to be used to help conduct the meeting.

During the meeting the MSAT representative should:

- Review administrative responsibilities of the MA.
- Review the project record keeping requirements.
- Review required paperwork with the MA.
- Remind the Municipality that this is a reimbursable program and they must pay the Contractor (and Consultant, if applicable) first, and bill the Department for reimbursement of eligible costs.
- Ensure the MA is aware that changes or substitution in inspection personnel must be approved by the Department.
- Ensure that the Municipality is aware that they may not be reimbursed for additional items or increases in quantities without prior Department approval.
- Ensure that the Municipality is aware of the testing requirements and that the Department may not reimburse the Municipality for the deficient items, or items not properly tested (proper sampling, testing, and testing equipment).
- Identify who is responsible for doing the mark out for Bituminous Concrete Core Sampling. (The core density testing must be done by the Division of Materials Testing (DMT) Refer to the Bituminous Concrete Section 4.06).

- Ensure that the Municipality is aware that proper testing equipment in good working condition must be used and that testing must be done in accordance with the specifications. The equipment must be calibrated when applicable. Convey to the Municipality that assurance testing is required for nuclear density gage compaction and concrete testing. These tests should be done early in the project to promptly address any deficiencies.
- Ensure that the Municipality is aware of the Buy America requirements for steel permanently incorporated into the project. Failure to enforce this provision can result in withdrawal of federal funds from all phases of the project, such as Rights of Way and Design.
- Inform the Municipality that they must schedule an EEO meeting and it should be incorporated into the Preconstruction meeting. Provide the Municipality with guidance where EEO documents can be obtained.
- Inform the Municipality to contact the Department of Labor Office to invite a representative to the Preconstruction meeting. Currently the contact phone number is 860-240-4278.
- Inform the Municipality to send a "Notice to Proceed" letter to the Contractor once the start date is determined.
- Remind the Municipality that no payments will be processed for regular item overruns or new items unless an appropriate construction order has been approved by the District MSAT Leader.
- Explain Frequently Used Terminology:
 - Pre-Award Commitment (PAC): A Pre-Award Commitment package is submitted at the bid time on a project. It lists the various firms in the applicable program (DBE or SBE) that the Contractor has committed to subcontract with to achieve the respective DBE goal or SBE set-aside.
 - The Federal DBE Program: The Disadvantaged Business Enterprise (DBE) program is a federal goal program and applies to Projects with federal funding.
 - Commercially Useful Function (CUF): A DBE/SBE firm is considered to be performing a CUF when they are responsible for the execution of the work of the Contract and are carrying out their responsibilities by actually performing, managing, and supervising the work involved with their own force and equipment. The certified DBE firm must be responsible for procuring, negotiating price, determining quantity and paying for all materials (where applicable) associated with their work. Projects may only use firms certified as DBEs to meet the stated percentage in the contract for federally funded projects.
 - The State SBE Program: The Small Business Enterprise (SBE) program is a state set-aside program and applies to projects without federal funds. Projects may only use firms certified as SBE set-aside to meet the percentage in the contract for State-funded projects.
 - Interim and Final DBE & SBE Participating Report Form 88-1: A Final Form 88-1 shall be filled out by the MA at the completion of the project to determine if the DBE goal/SBE set-aside has been achieved.
- Make sure the Municipality is aware that they are obligated to ensure their contractor(s) and consultant(s) comply with DBE requirements. Failure to do so can result in withdrawal of federal funds.
- Make sure the Municipality is aware that the Department must approve all time extensions, and decisions not to enforce liquidated damages. Failure to do so may impact the Department's reimbursement.
- Ensure projects with a contract value greater than \$150,000.00 have full time inspection, whether Town inspected or Consultant inspected. Required inspection shall cover identified critical items of work to verify compliance with the requirements of the plans and specifications.
- Review the number of calendar days allowed for the project. Discuss how they plan to handle winter shut down or winter work if the contract time spans a winter period.

- After the Municipality submits, in writing, the list of personnel and qualifications including all personnel of the Consultant who will be billing the project, the District MSAT Leader will review and approve the list prior to the start of construction reimbursement.
- Notify the MA that any Consultant raises must be approved by the Municipality and submitted to the MSAT Leader for Department participation. No raises will be eligible without these approvals. Wage increases are based within the maximums in the agreement.

1-2104 MSAT Project Status

The MSATs are to update, on a regular basis, their Municipal Projects file (District Shell) located in the MSAT Project Status folder contained in the Shared Drive.

1-2105 Municipal Preconstruction Meeting

A Municipal Preconstruction Meeting should be held before construction is authorized to proceed. Invitations are sent to various stakeholders such as the Municipal Administrator, MSAT, Consultant, Utilities and others. The Municipalities/Consultants are to conduct the meeting, the MSAT member is there for assistance.

At the preconstruction meeting the MSAT members should:

- Obtain the Contractor's emergency phone numbers from the Municipality and the Municipality/Consultant day and after hour phone numbers.
- Ensure the Municipality provides the Contractor with the subcontractor packet which contains EEO information.
- Ensure the Municipality informs the Contractor that no payments will be processed on items that do not meet the testing requirements.
- Ensure the Municipality reviews DBE/SBE/EEO/Affirmative Action/Pre-Award Commitments (PAC). (Refer to Volume I Chapter 12 "Civil Rights" for additional information).
- Ensure the Municipality reviews fulfillment of CUF.
- Ensure the Municipality reviews "Prompt Payment Complaints" (Refer to Volume I Chapter 12 "Civil Rights" for additional information).
- Ensure the Municipality reviews Compliance and Requirements for the Department of Labor. (Refer to Volume I Chapter 12 "Civil Rights" for additional information).
- At the conclusion of the meeting, request a copy of the attendance sheet from the Municipality.

1-2106 Municipal Testing Procedures

Materials testing procedures for Municipal Projects are to follow the criteria established in the latest edition of the [DMT Manual](#), Chapter 7 "Suggested Minimum Schedule for Acceptance Testing (LOTICIP)."

Each District has an email account setup to receive Municipality Systems Request for Test (MAT-100) from Municipal Projects.

MSAT members are responsible for ensuring MAT-100 are uploaded into SiteManager and any problems corrected. MSAT members are also responsible for forwarding the testing results to the Municipality/Consultant during the course of the project.

When the project is complete, the MSAT is to obtain from the Municipality/Consultant an Apparent Final Quantity (AFQ) report. The District will forward the AFQ to the DMT. When the AFQ is returned from the DMT, the MSAT Leader will send a copy of the AFQ to the Municipality/Consultant to address any exceptions noted. After the Municipality responds to all exceptions, the District forwards a memorandum to the DMT requesting the Final Material Certification. Once the Final Material Certification is received from the DMT, the District sends a copy to the Municipality for their files.

1-2107 Municipal Contract Status Report, CON 100M

The Districts will distribute any Municipal Contract Status Report (CON 100M) received from a Municipality to designated offices based on current distribution lists. MSAT is to also update the District Shell on the Department Shared Drive and provide OOC with requisite information about the project so it can be entered in SiteManager.

1-2108 Invoice Summary and Processing (ISP) for Projects Performed by Contractor/Consultant

The Municipality supplies the ISP (one original package and one copy of package) to Finance and Administration to log in the ISP and send to the District for review and approval. The MSAT reviews the previous ISP and correlates with the new ISP.

The ISP should be checked as follows:

- The original ISP should not be marked up, the copy of the ISP should be used to document the review.
- Verify changes in contract item quantities and new items are being incorporated by construction order. If construction orders are not being managed in a timely manner, exceeding the original amount should not be allowed.
- Verify that the material testing is in compliance prior to reimbursement by checking the testing results in SiteManager.
- Verify steel incorporated into the project complies with Buy America provisions. This includes all steel products installed by the Contractor regardless of who acquired the material.
- Ensure there is a copy of the cancelled check to the Contractor/Consultant or verification from the Contractor/Consultant stating amount paid.
- Review prior billing amounts on the summary.
- Ensure that the Inspection costs are signed by the Municipal Administrator for wages and hours for Municipal charges.
- Ensure that the time sheets or time card copies are attached.
- Check to ensure the time billed is correct.
- Ensure the math is correct.
- Check approved Consultant wage rates to ensure no raises have been given without the Municipal and the Department approval.
- Review mileage sheets, which should contain backup to support mileage charged. Note: Only on-site mileage is allowed. Ensure that the rate used is what is allowed per the agreement.
- Ensure receipts have been attached when postage, photography bills, telephone bills, or any other appropriate direct cost reimbursements are requested. All telephone charges must be highlighted to indicate which calls are applicable to the project for reimbursement.
- Document any items that are being withheld from reimbursement, and notify the Municipality.
- Be aware of the limiting amounts established in the agreement and do not exceed without a supplemental agreement.

- For any adjustment sheets/corrected sheets make the following copies:
 - 1 copy for the original package
 - 1 copy for MSAT file
- Once the invoice is checked and acceptable to pay, send the ISP and all spreadsheets to the Municipality contact.
- Return the original ISP signed by the MSAT Leader and the documented adjustments/corrections to Finance and Administration. Retain one copy of these documents in the District file.
- Update the Municipal payment log maintained by MSAT or monitor DOT Viewport.

1-2109 ISPs for Projects Performed by Municipal Force Account

The Municipality supplies the ISP (one original package and one copy of package) to Finance and Administration to log in the ISP and send to the District for review and approval. The MSAT reviews the ISP to ensure it is accurate and complete.

The backup should include the following:

- Monthly summary of material, labor and equipment.
- Labor substantiated with daily time sheets or logs.
- Equipment paid according to the agreement and broken out as to what is used daily on a log.
- Material broken out as to what is put in per day.
- Material invoices and or receipted bills provided for support.

The processing of invoice is the same as noted in 1-2108 above.

1-2110 Change In Scope - Approval Process

When a Municipality proposes a change in scope or a significant amount of extra work to a contract, the following tasks must be performed:

- The Municipality must determine the work is necessary and contact the District, in writing, for concurrence.
- The District will coordinate a determination with Design and forward the decision, in writing, to the Municipality. The Department must assess that it is in the public interest (Public Interest Finding) to perform the work through construction order and not by advertising a separate contract.
- The District with Design's help will determine if any changes are required to the federal aid agreement.
- The MSAT will determine if funding is available and initiate project modification to secure additional funds, if necessary.
- If the change is incorporated into the project, a construction order shall be prepared and approved by the Municipality, and subsequently the participating funding approved by the District prior to reimbursement.
- If cumulative changes are greater than ten percent (10%) of the construction costs as stipulated in the Department/Municipal agreement, then a supplemental agreement is required. The District should assist Design in coordinating the supplemental agreement.

Under no circumstances should the District suspend the work. It should be explained to the Municipality that before the Department will participate in any changes, proper approval must be in place; however, the

Municipality can authorize the work to be performed without Department approval with the understanding that it may not be reimbursable and would be the sole responsibility of the Municipality.

1-2111 Municipality Construction Orders

Draft construction orders should be submitted by the Municipality to the District MSAT Leader for review prior to processing.

The MSAT Leader should check if appropriate procedures are being followed.

- Ensure there is proper back up and price justification for new items.
- Ensure reasons are being provided for increases/decreases that are more than 10% and \$10,000.00.
- Ensure reasons are being provided for known issues regardless if original items are being used.
- Ensure that the construction order items are eligible for participation.

The MSAT Leader also needs to make sure there is sufficient funding available to cover the construction order amount. If the proposed construction order causes the project value to exceed 110% of the original contract value, the MSAT Leader needs to contact Engineering to find out if additional funding is available, and if so, start a modification to secure that funding. When additional funding is required the State/Municipality agreement needs to be reviewed and supplemented if necessary.

Once the draft construction order has been reviewed and deemed acceptable, the construction order is returned to the Municipality for processing.

Once the Municipality has returned the construction order with signatures (1 signed original and 1 copy), forward the original to Supervising Engineer for approval.

- A copy is retained in the District's file.
- Once the Supervising Engineer returns the original to the Project Engineer, a copy of the page is made with the approval for the District's file.
- The approved construction order is forwarded to the Municipality.
- District approved time extensions are to be incorporated into a construction order.

1-2112 Claim Procedures

The Municipality should inform the MSAT Leader immediately if a claim is submitted or a lawsuit is filed on the project. The MSAT Leader should find out the particulars of the submitted claim or filed lawsuit from the Municipality. They should also review the State-Municipality Agreement for allowable participation.

The MSAT Leader is to inform the District Engineer of their finding and then notify the Office of Construction (OOC). Notification and a copy of the claim or lawsuit should be provided to the OOC Construction Division Chief and the Principal Engineer of the Claims and Litigation Section.

The OOC Principal Engineer of Claims should be contacted to discuss the claim or lawsuit and the Department's role.

1-2113 Project Intermediate Records Review

It is the responsibility of the MSAT Leader to ensure Municipality/Consultant is keeping records that substantiate the work paid and those records conform to minimum standards. This is documented by completing project records review using the Project Intermediate Review form. The frequency of these reviews should be at least once every 3 months.

- A copy of the latest approved ISP (with the attached latest estimate) from the District office should be used when performing the review.
- Payment items are reviewed using the checklist.
- Using the latest paid estimate, select items that have been paid. Normally, items that have computations are checked. It is recommended to also check any Cost Plus items if applicable. Review between six to eight items, with a minimum of three entries per item. (If there have been no estimates submitted yet, review Volume II and see what items have been worked on and review those items).
- Ensure that the DWR refers to the computations.
- Review the DWRs to see that all pertinent data is recorded.
- If paving or placing processed aggregate base, ensure that the CON-136 Bituminous Reports (or equivalent) are being used.
- Send a copy of the Review to the OOC Quality Assurance Section.
- If linear foot items are checked, ensure that there is a “field measured by” sign off by an inspector.
- In the Volume II, ensure that there is a record of the construction order quantities for the items.
- In the Volume II, ensure that there is a record of the testing, as well as a “Request for Test Index.” The “Request for Test Index” should be used to verify that the material testing requirements are being performed adequately.
- Check that the Volume IV is being maintained and that all of the required sheets are included.
- Ensure that the appropriate numbers of labor wage checks are being performed.
- Ensure that the payrolls for the Contractor and all subcontractors are recorded.
- Ensure that the equipment actually used on the project for the Contractor and each subcontractor is being recorded.
- Give the Municipality the modification dollar value to use in the Volume IV.
- Sign and date the Volume IV indicating that a records review was performed.
- Ensure that the CLA-12’s are in the Volume IV if the subcontractors have worked.
- Once the review is complete and all checklist questions have been answered, sign the checklist.
- Prepare a letter for the Municipality Representative transmitting the review to them. Allow the Municipality 30 days to address the exceptions.

All Periodic Record Reviews must be kept in the Volume IV Miscellaneous Contract Data book and a copy sent to the OOC Quality Assurance Section.

Figure 1-21.2 Project Intermediate Review

PROJECT ADMINISTRATION REVIEW

Project No. _____	Month: _____
FAP No. _____	Year: _____
Date of Review: _____	Report No.: _____
Town: _____	Chief Inspector: _____
Original Contract Value: _____	Original Calendar Days: _____
Revised Contract Value: _____	Revised Calendar Days: _____
Estimate to Date: _____	Days Used to Date: _____
	<small>(Including Winter Shutdown)</small>

* See comments and explanations on page 2

		* Yes	No	N/A
1. Has CON-100 M been signed by the Town and distributed?	<input type="checkbox"/>	<input type="checkbox"/>	<input type="checkbox"/>	<input type="checkbox"/>
2. Are DWR's up-to-date and contain the pertinent information/ documentation (as per manual)?	<input type="checkbox"/>	<input type="checkbox"/>	<input type="checkbox"/>	<input type="checkbox"/>
3. Are 5 DWRs per month sign by the Municipal Administrator and the remainder signed by others?	<input type="checkbox"/>	<input type="checkbox"/>	<input type="checkbox"/>	<input type="checkbox"/>
4. Is the CON-136 Base/Bituminous Reports for paving operations being used?	<input type="checkbox"/>	<input type="checkbox"/>	<input type="checkbox"/>	<input type="checkbox"/>
5. Is the Volume II being maintained, as per manual, including posting of test results?	<input type="checkbox"/>	<input type="checkbox"/>	<input type="checkbox"/>	<input type="checkbox"/>
6. Is the Volume III (computations book) following format to provide acceptable audit trial?	<input type="checkbox"/>	<input type="checkbox"/>	<input type="checkbox"/>	<input type="checkbox"/>
7. Is the Volume IV (miscellaneous data) up to date?	<input type="checkbox"/>	<input type="checkbox"/>	<input type="checkbox"/>	<input type="checkbox"/>
8. Is the submission of payrolls (prime/subs) recorded and up to date?	<input type="checkbox"/>	<input type="checkbox"/>	<input type="checkbox"/>	<input type="checkbox"/>
9. Are there sufficient Labor Wage Checks (as per manual)?	<input type="checkbox"/>	<input type="checkbox"/>	<input type="checkbox"/>	<input type="checkbox"/>
10. Is the submission /processing of Payment Estimates in order?	<input type="checkbox"/>	<input type="checkbox"/>	<input type="checkbox"/>	<input type="checkbox"/>
11. Is the reconciliation sheet on payment estimates broken down by Eligible/Non-Eligible?	<input type="checkbox"/>	<input type="checkbox"/>	<input type="checkbox"/>	<input type="checkbox"/>
12. Are the submission/processing of Change Orders in order?	<input type="checkbox"/>	<input type="checkbox"/>	<input type="checkbox"/>	<input type="checkbox"/>
13. Do the Change Orders follow acceptable format and contain appropriate backup information?	<input type="checkbox"/>	<input type="checkbox"/>	<input type="checkbox"/>	<input type="checkbox"/>
14. Are Change Orders being submitted to DOT for approval? Number approved to date: _____ Change Order Pending: _____	<input type="checkbox"/>	<input type="checkbox"/>	<input type="checkbox"/>	<input type="checkbox"/>
15. Is the testing of materials being complied with?	<input type="checkbox"/>	<input type="checkbox"/>	<input type="checkbox"/>	<input type="checkbox"/>
16. Is assurance testing being done?	<input type="checkbox"/>	<input type="checkbox"/>	<input type="checkbox"/>	<input type="checkbox"/>
17. Is the submission/processing of ISPs in order?	<input type="checkbox"/>	<input type="checkbox"/>	<input type="checkbox"/>	<input type="checkbox"/>
18. At this time, will the contract meet its minority D/SBE requirements? (Agreements on file at field office?)	<input type="checkbox"/>	<input type="checkbox"/>	<input type="checkbox"/>	<input type="checkbox"/>
19. Are the submission of DBE Quarterly Reports up to date?	<input type="checkbox"/>	<input type="checkbox"/>	<input type="checkbox"/>	<input type="checkbox"/>
20. Is the percentage of work completed (days used) on schedule?	<input type="checkbox"/>	<input type="checkbox"/>	<input type="checkbox"/>	<input type="checkbox"/>
21. Does the Municipality have a subcontractor's approval process?	<input type="checkbox"/>	<input type="checkbox"/>	<input type="checkbox"/>	<input type="checkbox"/>
22. Has the Municipality approved all the subcontractors working on the project?	<input type="checkbox"/>	<input type="checkbox"/>	<input type="checkbox"/>	<input type="checkbox"/>
23. Are the field inspection forces providing satisfactory overall inspection/administration of the project?	<input type="checkbox"/>	<input type="checkbox"/>	<input type="checkbox"/>	<input type="checkbox"/>
24. Is the Municipality providing satisfactory administration of the project?	<input type="checkbox"/>	<input type="checkbox"/>	<input type="checkbox"/>	<input type="checkbox"/>
25. Are all other activities/areas of contract administration proceeding in accordance with DOT standards?	<input type="checkbox"/>	<input type="checkbox"/>	<input type="checkbox"/>	<input type="checkbox"/>
26. Verify with the Town Administration that all material meets Buy America specifications?	<input type="checkbox"/>	<input type="checkbox"/>	<input type="checkbox"/>	<input type="checkbox"/>
27. Are the DBEs fulfilling CUF on Labor and Equipment?	<input type="checkbox"/>	<input type="checkbox"/>	<input type="checkbox"/>	<input type="checkbox"/>

PROJECT ADMINISTRATION REVIEW

Project No. _____
FAP No. _____
Date of Review: _____

Month: _____
Year: _____
Report No.: _____

<u>Item No.</u>	<u>Description</u>	<u>DWR's Reviewed</u>	<u>Reviewed through Estimate No.</u>
_____	_____	_____	_____
_____	_____	_____	_____
_____	_____	_____	_____
_____	_____	_____	_____
_____	_____	_____	_____
_____	_____	_____	_____
_____	_____	_____	_____
_____	_____	_____	_____
_____	_____	_____	_____
_____	_____	_____	_____

Comments and/or Explanations:

MSAT Representative

Date

Project Engineer

Date

1-2113A Final Review of the Project Records

The Districts conduct the Final Review of the project records. Any exceptions resulting from this review will be transmitted to the Municipality for resolution and response. A copy of the Final Review with the notations that any discrepancies have been addressed or a No Further Action Necessary notification shall be sent to the OOC Quality Assurance Section.

Municipality Administered Projects

	District Offices	Office of Construction
Intermediate Reviews	All Projects <u>Note: The Monthly Checklist shall be considered the review</u>	Not Applicable
Final Reviews	All Projects (except when performed by OOC) <u>Note: A copy of the review shall be forwarded to OOC</u>	OOC will perform one (1) Final Review per District, per year, by random sampling. <u>Note: A Final Review is not required by the District in this case.</u>

1-2114 Semifinal and Final Inspection

Semifinal Inspection

- The Municipality should schedule and invite all necessary parties to the inspection. The MSAT Leader should attend.
- Ensure that the Municipality invites the Design Liaison Unit.
- The Municipality should create a punch list of deficiencies found at the inspection and send a copy to the attendees.

Final Inspection by Town

- Once the Municipality knows that all of the semifinal punch list items have been addressed in a satisfactory manner, the Municipality shall check that the project is acceptable.
- Once the Municipality is satisfied the project is acceptable, the Municipality shall notify the District in writing and request the District’s Final Inspection.

Final Inspection by Department

- Once the District is notified that the project is acceptable, the MSAT Leader needs to ensure all deficiencies on the punch list were corrected.
- Once the MSAT Leader is satisfied, the MSAT Leader notifies the Supervising Engineer so that Final Inspection can be arranged.
- If all is acceptable, the CON 502, A, C, D, M, T forms can be filled out and submitted.
- Once all CON 502 forms are submitted, the Department CON 500M form is to be filled out and signed by the District and the Municipality.

1-2115 Closing Out Projects

This Chapter contains substantial completion, project acceptance, and close-out guidelines for projects. Project completion and close-out are important components of the overall project administration process. The project is not complete until it is accepted by the Municipality. Acceptance cannot take place until all physical and administrative requirements are complete. The following process has been developed to facilitate the timely close-out of projects. Recognizing that projects differ in complexity and size, time frames to close-out a project will vary; however, for most projects the close-out process should be completed within 3 months of Substantial Completion unless there are extenuating circumstances such as performance requirements or warranties.

The MA should regularly prepare project staff for close-out of the project by overseeing the completion of project records, quantity computations, summary sheets, materials testing, as-built plans, and other administrative requirements *as the work progresses* or shortly after the physical work of an item (or group of related items) is completed in the field. Any problems or deficiencies discovered during item close-out should be noted and resolved in a timely manner while the Contractor is still on site. As the work on the project nears completion, the requirements to accept the work, including administrative requirements, must be discussed with the Municipality and project staff on a regular basis. A standing item should be included at project Progress Meetings to address these issues. Prior to scheduling the Semi-Final Inspection, the majority of the project items should be checked and balanced.

After the Final Review has been satisfied, the following is the procedure for closing out projects:

- The finals package is completed by the MA and is forwarded to the OOC.
- The memo for External Audits is prepared by the MA and a copy of coded ISP and associated spreadsheets for audit.
- The Municipality prepares the CON 501M form.
- External Audits will notify the Municipality in writing of the results of the audit report.

1-2116 Submission of the Finals Package to the Office of Construction

The submission of a Final Package must be sent electronically from the District to the OOC. The final submittal requirements for each category of the project are listed below.

The [Final Package Supporting Documents Checklist Memorandum](#) and supporting documents are to be emailed as *individual, separate* files to the OOC, Quality Assurance Section. The CON-501 Certificate of Acceptance of Project will be submitted to the OOC, as well.

The following naming convention will be used to aid in the filing and retrieval of the electronic files:

XXXX-XXXX_BriefSubjectName
(Contract No)_(Description listed on Final Transmittal Memorandum)

Any documents not correctly labeled will be returned, thereby delaying the processing of the Final Package.

FHWA Funded Projects – Municipal (contracts awarded by the Municipalities)

Required forms (if applicable)

- Letter of Transmittal
- CON 100M
- Construction Report
- Final Construction Order
- Final Materials Certificate
- Final Item Quantities (Par and Non-Par broken out)
- Final DBE / SBE Participating Report Form 88-1
- Time Extension(s) (if applicable)
- CON 502's (A, C, D, M & T)
- CON 500M
- CON 501M
- Post Construction Review

Department Funded Projects – Municipal (contracts awarded by the Municipality)

Required Forms (if applicable)

- Letter of Transmittal
- CON 100M
- Construction Report
- Final Materials Certificate
- Final Estimate ISP
- Credits Due Department
- District Final Review Report of Project Records
- Form 88-1
- Time Extension(s)
- CON 502's (A, C, D, M & T)
- CON 500M
- CON 501M
- Post Construction Review

Force Account Projects – Municipality (all)

Required Forms (if applicable)

- Letter of Transmittal
- CON 100M
- Construction Report
- CON 502A, M, T
- CON 501M
- Letter accepting all materials incorporated into the project (from Municipality)

Chapter 22 - Facilities Construction

1-2201 Overview

The Department is responsible for the construction and rehabilitation of multiple transportation related facilities throughout the state. Facilities Construction is defined as the type of construction that requires the issuance of a Certificate of Compliance by the State Building Inspector or his authorized representative at the completion of a project, and includes site work considered ancillary to this type of construction. See Figure 1-22.6.

Some typical examples of facilities construction projects administered by the Department would be:

- Airport Facilities (Terminals, Hangers)
- Railroad Stations and Platforms
- Railroad Repair Shops and Administrative Buildings
- Parking Garages
- Bus Facilities
- Roadway Maintenance and Repair Garages
- Salt Sheds
- Piers and Docks
- Other facilities operated by the Department

1-2202 Unit Responsibilities

The successful completion of a facilities construction project requires close coordination and cooperation between several Departmental Units and outside agencies, each with their own unique responsibilities.

- *Construction:* District personnel are responsible to provide Contract Inspection and Administration. During construction, they coordinate with other DOT units, the Contractor and outside agencies. The District processes all correspondence, holds meetings and teleconferences, verifies compliance with Contract Specifications and Requirements, arranges code inspections and maintains project records in accordance with established Departmental standards.
- *Facilities Design:* Acts as the Designer of record (if in-house design) or liaison to Designer (if outside consultant). They are responsible to respond to Requests for Information (RFI's), resolve design related construction issues by providing clarification or interpretation of Contract Documents, issue Change Orders (CO's) and Field Design Changes (FDC's) as required and attend meetings to monitor and resolve concerns.
- *Properties and Facilities Services:* Provide required code inspections in accordance with governing State Building and Fire Codes (See Section 1-2211 Code Inspections Schedule). Issue a "Notice of Intent to Construct/Renovate/Repair/Retrofit a Non-Threshold Structure" to the Office of the State Building Official (See Figure 1-22.1). Provide clarifications and interpretations of codes as they relate to the Project. Ultimately responsible for the issuance of a Certificate of Substantial Compliance, allowing occupancy of the facility, as well as acceptance of the Project by the Department as being code compliant.
- *Bureau of Public Transportation:* Both the Office of Rails and the Office of Transit and Ridesharing are responsible for the financial oversight of rail and transit projects. Representatives of both offices are the liaison between the end-user, Facilities Design, and Construction Units. Review and authorize all non-design related issues, as well as requests for changes from the end-user.

- *Bureau of Public Transportation, State Maritime Office:* This office is responsible for the financial oversight of certain port projects. Representatives of this office are the liaison between the end-user, Facilities Design, and Construction Units. Review and authorize all non-design related issues, as well as requests for changes from the end-user.
- *Owner:* The facilities constructed are generally owned by the State of Connecticut; however, the end-user may be a different entity. The State, or its designee, is responsible for maintaining these facilities.
- *Outside Agencies:*
 - Department of Public Safety: Building and Fire Officials from the Department of Public Safety (DPS), in conjunction with the Office of Properties and Facilities Services, are responsible to perform code inspections on threshold buildings (see below). DPS Officials also perform code inspections of conveying devices (elevators, escalators, etc.) and boilers, and provide certifications. Upon request of Department's Building Official, provide interpretations of building codes.
 - Department of Environmental Protection: Fuel pumps require DEP inspections prior to being put into service.
 - Others: Department of Weight and Measures (to certify fuel pumps), Department of Public Health (water and septic) and OSHA (safety) may be encountered.

NOTE: Threshold Buildings: Pursuant to Connecticut General Statute (C.G.S.) 29.2591a, buildings exceeding any of the following five threshold limits are considered "threshold buildings" and must be inspected for code compliance by the Office of the State Building Official:

1. Four stories,
2. 60-feet high,
3. A clear span of 150-feet wide,
4. 150,000 square feet of floor space,
5. Occupancy by 1,000 or more people.

These inspections would still be coordinated through the Office of Properties and Facilities Services.

Figure 1-22.1 Notice of Intent

[Today's Date]

Mr. Christopher Laoux
 State Building Inspector
 Department of Public Safety
 Division of State Building Inspector
 1111 Country Club Road
 Middletown, CT 06457-9294

Dear Mr. Laoux:

RE: Notice of Intent to (Construct / Renovate / Repair / Retrofit a Non-Threshold Structure

Please be advised that the Department of Transportation, Bureau of Finance and Administration, Division of Property and Facilities Services, intends to construct a state-owned structure or building as described below:

Agency: Department of Transportation
Agency Representative: Philip E. Parcak – Tel. (860) 594-2233, Fax (860) 594-2255
Project Location:
Address:

DOT Project Number:
Permit Number:
Type of Work: Construct – Renovation – Repair - Retrofit
Building Information: Construction Type _____ Height _____
 Use Group _____ Number of Stories _____

Description of Work:

The tentative project completion date is estimated as _____

Construction inspection will be performed under the direct supervision of Property and Facilities personnel, as they are licensed by your office to insure compliance with the State Building Code.

An application for a Certificate of Compliance will be forwarded to you when the actual project completion date is determined.

If you have any questions, please contact me at telephone number (860) 594-2233.

Sincerely,

Philip E. Parcak (B.O. 017-90)
 Principal Engineer
 Bureau of Finance and Administration

1-2203 Obtaining a Certificate of Substantial Compliance

The steps needed to obtain a Certificate of Substantial Compliance (COC) are outlined in the following flowchart:

Figure 1-22.2 Certificate of Substantial Compliance Flowchart

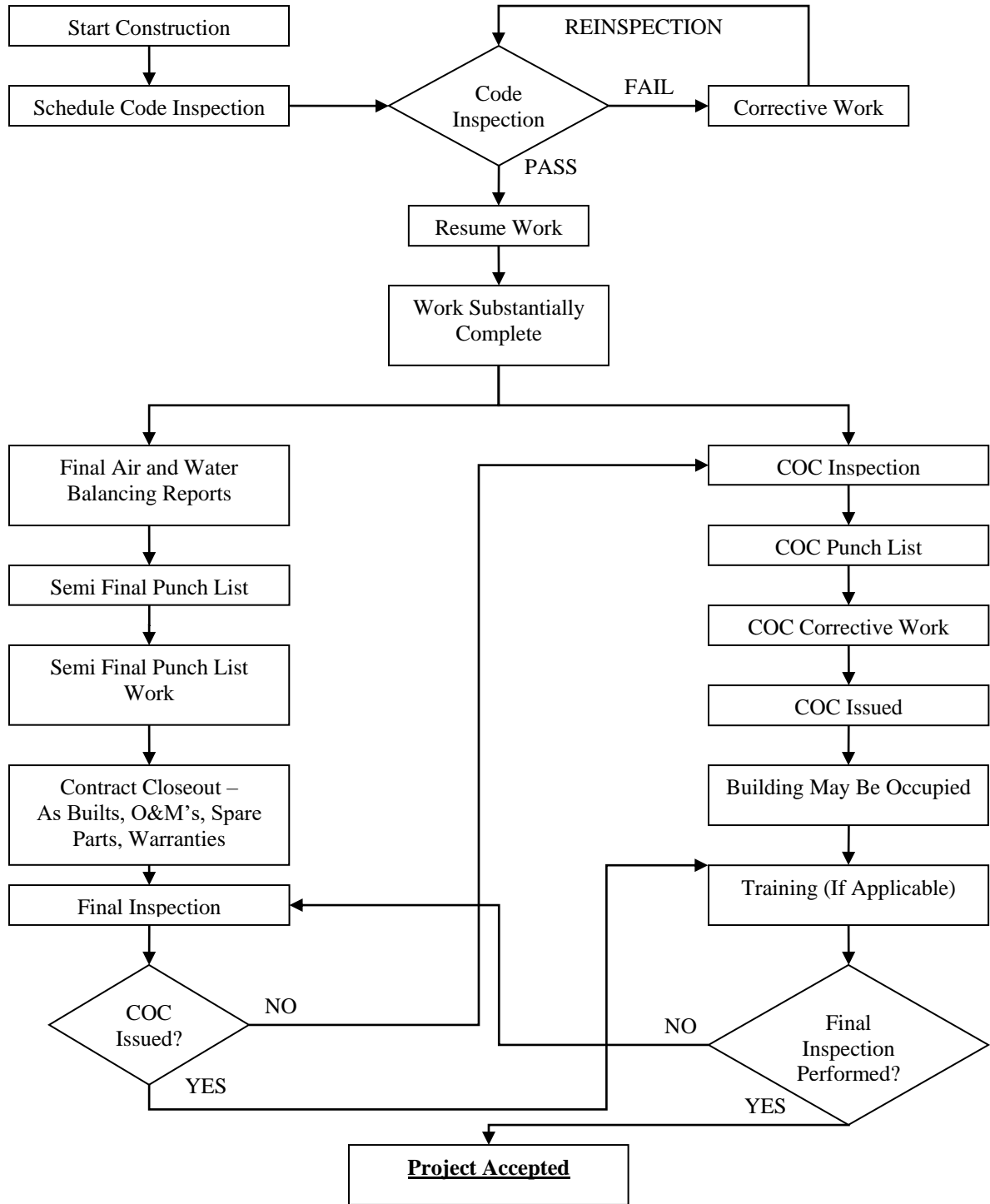

1-2204 Construction Specification Institute (CSI) Items

Facilities construction projects consist of standard and special provision items, including as a special provision, a “Major Lump Sum Item” (MLSI). The MLSI is typically assigned a name such as “Rail Facility” or “Bus Facility Upgrade” and includes all the Construction Specification Institute (CSI) items in the Contract. CSI categorizes the individual components of building trades into distinct divisions, with specific sections in each division. Although more divisions exist, generally you will encounter the following:

- Division 01 – General Requirements
- Division 02 – Existing Conditions
- Division 03 – Concrete
- Division 04 – Masonry
- Division 05 – Metals
- Division 06 – Wood, Plastics and Composites
- Division 07 – Thermal and Moisture Protection
- Division 08 – Openings
- Division 09 – Finishes
- Division 10 – Specialties
- Division 11 – Equipment
- Division 12 – Furnishings
- Division 13 – Special Construction
- Division 14 – Conveying Equipment
- Division 21 – Fire Suppression
- Division 22 – Plumbing
- Division 23 – Heating, Ventilating and Air Conditioning
- Division 26 – Electrical
- Division 27 – Communications
- Division 28 – Electronic Safety and Security
- Division 31 – Earthwork
- Division 32 – Exterior Improvements
- Division 33 – Utilities

NOTE: Section 1.20 of the Form 816 is used in lieu of Division 1 – General Requirements. Additionally, there are several specialized CSI divisions not listed as well as several reserved for future use. For more information, see [CSI Master Format 2004](#).

1-2205 Project Start Up

Once the Contract is awarded, the Contractor must submit a “Schedule of Values” (See Figure 1-22.3). This schedule associates a dollar amount for each CSI section of the Contract. The values submitted are to be an approximate representation of the value of the work, but are not to be used as the basis for a credit if work is eliminated. The schedule of values total must equal the amount of MLSI. The schedule of values is reviewed and approved by the District. Once approved, the schedule of values will become the template for the monthly AIA payment requisitions submitted by the Contractor (See Section 1-2206 Payment Estimates). Please note that there should be no monetary allowances for any Division 1 items in the schedule of values as is typically indicated in the Contract.

Figure 1-22.3 Schedule of Values

PROJECT NO. 0123-456		
SCHEDULE OF VALUES		
0100152A - INTERIM SHOP MAINTENANCE FACILITY, \$8,782,700.00		
CSI SECTION	DESCRIPTION	VALUE
033000	CAST-IN-PLACE CONCRETE	\$2,300,000.00
055000	METAL FABRICATIONS	\$74,000.00
055213	PIPE AND TUBE RAILING	\$65,000.00
061053	MISCELLANEOUS ROUGH CARPENTRY	\$14,000.00
072700	AIR BARRIERS	\$20,000.00
079200	JOINT SEALANTS	\$20,000.00
087100	DOOR HARDWARE	\$17,200.00
092613	GYPSUM VENEER PLASTERING	\$22,000.00
092900	GYPSUM BOARD	\$35,000.00
095113	ACOUSTICAL PANEL CEILING	\$4,000.00
099100	PAINTING	\$109,000.00
102113	TOILET COMPARTMENTS	\$4,000.00
102800	TOILET, BATH, AND LAUNDRY ACCESSORIES	\$5,000.00
104400	FIRE PROTECTION SPECIALTIES	\$2,500.00
105113	METAL LOCKERS	\$51,000.00
133419	METAL BUILDING SYSTEMS	\$1,800,000.00
211313	WET-PIPE SPRINKLER SYSTEM	\$160,000.00
213113	ELECTRIC-DRIVE, CENTRIFUGAL FIRE PUMPS	\$60,000.00
220500	COMMON WORK RESULTS FOR PLUMBING	\$95,000.00
230500	COMMON WORK RESULTS FOR HVAC	\$680,000.00
260500	COMMON WORK RESULTS FOR ELECTRICAL	\$3,200,000.00
283111	DIGITAL, ADDRESSABLE FIRE-ALARM SYSTEM	\$45,000.00
	TOTAL	\$8,782,700.00

On large complex facilities projects, an internal information only change order may be created, at the discretion of the District, within the SiteManager change order process. This document will facilitate the tracking of the applicable CSI divisions and testing within the project records. This change order is NOT to be issued to the contractor and is optional for each Project. The items are created using item descriptions already existing in SiteManager with the prefix “F”, as appropriate. At a minimum, the first generic item for each applicable CSI Division (ex. F330000 – Utilities) is entered. Additional “F” items may be entered if the project staff necessitates. The items are assigned a quantity of 1 (one) and a unit price of \$0.00 (zero dollars), as payments will still be made under the original MLSI.

Please note that the creation of the CSI oriented item numbers are intended to provide the inspection staff a means to identify and track contractor activity and the various materials for testing that are associated with the various CSI Divisions. The requests by the Prime Contractor to Subcontract (CLA-12) should reference the original bid item (ex. 0101050A – Maintenance Facility) that the subcontractor will be performing work under.

1-2206 Payment Estimates

At the conclusion of each payment estimate period, the Contractor is required to submit an American Institute of Architects (AIA) Form G702, “Application and Certificate for Payment” (See Figure 1-22.4), and AIA Form G703, “Continuation Sheet” (See Figure 1-22.5). The Chief Inspector reviews the draft requisition prepared by the Contractor, makes any corrections or alterations, and once satisfied, returns a copy to the Contractor. The Contractor then submits a final, notarized version, based on the approved draft. The Project Engineer then signs the front sheet of the (AIA) Form G702 in the Architect’s Certificate for Payment block lower right corner. The final Forms G702 and G703 become the basis of payment for the MLSI. The final AIA Forms G702 and G703, and a copy of the annotated draft requisition are to be kept in the Volume 3 with a Payment Summary Sheet for the MLSI.

If payment is requested for any Stored Materials, or any materials not yet incorporated into the Project, the Contractor must supply a receipted bill or Certification of Title, as specified under Article 1.09.06B of the Standard Specifications, Form 817. Additionally, the requested materials must have been submitted to the Designer for review and have a status of 'Conforms' or 'Conforms as Noted' to be eligible for payment. For lump sum items or other instances when the unit of material being paid under Material Stored on Site does not note the pay unit, a correlation between the two must be determined prior to any payments being made. See Chapter 9, Section 1-909, of the Construction Manual for the requirements prior to paying for Stored Materials. (This applies to materials stored on site, off site, and raw or partially fabricated materials).

Payment for all non MLSI work is to be done in accordance with typical Departmental Procedures and is not to be included in the AIA documents.

Figure 1-22.4 Sample AIA Form G702 Application and Certification for Payment

APPLICATION AND CERTIFICATION FOR PAYMENT		PAGE 1 OF 2																								
<p>TO OWNER: State of Ct Department of Transportation 2800 Berlin Turnpike Newington, CT 06131-7546</p> <p>FROM CONTRACTOR: ABC CONSTRUCTION 123 Main St. Anywhere, CT 06000</p> <p>CONTRACT FOR: Interim Shop Maintenance Facility</p>	<p>APPLICATION NO: 15 APPLICATION DATE: 13-Sep-06 PERIOD TO: 31-Aug-06</p> <p>VIA ARCHITECT: PROJECT NOS: 301-0081 MBI Project Nos. 10-50-05023</p> <p>CONTRACT DATE: 15-Jul-05</p>																									
<p>CONTRACTOR'S APPLICATION FOR PAYMENT Application is made for payment, as shown below, in connection with the Contract. Continuation Sheet, is attached.</p>																										
<table style="width:100%; border-collapse: collapse;"> <tr><td>1. ORIGINAL CONTRACT SUM</td><td style="text-align: right;">\$ 8,782,700.00</td></tr> <tr><td>2. Net Change By Change Orders</td><td style="text-align: right;">\$ N/A</td></tr> <tr><td>3. CONTRACT SUM TO DATE (Line 1 + 2)</td><td style="text-align: right;">\$ 8,782,700.00</td></tr> <tr><td>4. TOTAL COMPLETED & STORED TO DATE (Column G on Continuation Sheet)</td><td style="text-align: right;">\$ 4,478,730.00</td></tr> <tr><td colspan="2">5. RETAINAGE:</td></tr> <tr><td> a. 2.5 % of Completed Work (Columns D + E on Continuation Sheet)</td><td style="text-align: right;">\$ 111,968.25</td></tr> <tr><td> b. % of Stored Material (Column F on Continuation Sheet)</td><td style="text-align: right;">\$</td></tr> <tr><td>Total Retainage (Line 5a + 5b or Total in Column 1 of Continuation Sheet)</td><td style="text-align: right;">\$ 111,968.25</td></tr> <tr><td>6. TOTAL EARNED LESS RETAINAGE (Line 4 less Line 5 Total)</td><td style="text-align: right;">\$ 4,366,761.75</td></tr> <tr><td>7. LESS PREVIOUS CERTIFICATES FOR PAYMENT (Line 6 from prior Certificate)</td><td style="text-align: right;">\$ 4,025,775.00</td></tr> <tr><td>8. CURRENT PAYMENT DUE</td><td style="text-align: right;">\$ 340,986.75</td></tr> <tr><td>9. BALANCE TO FINISH, INCLUDING RETAINAGE (Line 3 less Line 6)</td><td style="text-align: right;">\$ 4,415,938.25</td></tr> </table>	1. ORIGINAL CONTRACT SUM	\$ 8,782,700.00	2. Net Change By Change Orders	\$ N/A	3. CONTRACT SUM TO DATE (Line 1 + 2)	\$ 8,782,700.00	4. TOTAL COMPLETED & STORED TO DATE (Column G on Continuation Sheet)	\$ 4,478,730.00	5. RETAINAGE:		a. 2.5 % of Completed Work (Columns D + E on Continuation Sheet)	\$ 111,968.25	b. % of Stored Material (Column F on Continuation Sheet)	\$	Total Retainage (Line 5a + 5b or Total in Column 1 of Continuation Sheet)	\$ 111,968.25	6. TOTAL EARNED LESS RETAINAGE (Line 4 less Line 5 Total)	\$ 4,366,761.75	7. LESS PREVIOUS CERTIFICATES FOR PAYMENT (Line 6 from prior Certificate)	\$ 4,025,775.00	8. CURRENT PAYMENT DUE	\$ 340,986.75	9. BALANCE TO FINISH, INCLUDING RETAINAGE (Line 3 less Line 6)	\$ 4,415,938.25	<p>The undersigned Contractor certifies that to the best of the Contractor's Knowledge, information and belief the Work covered by this Application for Payment has been completed in accordance with the Contract Documents, that all amounts have been paid by the Contractor for Work for which previous Certificates for Payment were issued and payments received from the Owner, and that current payment shown herein is now due.</p> <p>CONTRACTOR: ABC CONSTRUCTION</p> <p>By: _____ Date: _____</p> <p>State of: Connecticut County of: Hartford Subscribed and sworn to before me this _____ day of _____ Notary Public: My Commission expires: _____</p>	
1. ORIGINAL CONTRACT SUM	\$ 8,782,700.00																									
2. Net Change By Change Orders	\$ N/A																									
3. CONTRACT SUM TO DATE (Line 1 + 2)	\$ 8,782,700.00																									
4. TOTAL COMPLETED & STORED TO DATE (Column G on Continuation Sheet)	\$ 4,478,730.00																									
5. RETAINAGE:																										
a. 2.5 % of Completed Work (Columns D + E on Continuation Sheet)	\$ 111,968.25																									
b. % of Stored Material (Column F on Continuation Sheet)	\$																									
Total Retainage (Line 5a + 5b or Total in Column 1 of Continuation Sheet)	\$ 111,968.25																									
6. TOTAL EARNED LESS RETAINAGE (Line 4 less Line 5 Total)	\$ 4,366,761.75																									
7. LESS PREVIOUS CERTIFICATES FOR PAYMENT (Line 6 from prior Certificate)	\$ 4,025,775.00																									
8. CURRENT PAYMENT DUE	\$ 340,986.75																									
9. BALANCE TO FINISH, INCLUDING RETAINAGE (Line 3 less Line 6)	\$ 4,415,938.25																									
<p>ARCHITECT'S CERTIFICATE FOR PAYMENT In accordance with the contract Documents, based on on-site observations and the data comprising the application, the Architect certifies to the Owner that to the best of the Architect's knowledge, information and belief the Work has progressed as indicated, the quality of the Work is in accordance with the Contract Documents, and the Contractor is entitled to payment of the AMOUNT CERTIFIED.</p> <p>AMOUNT CERTIFIED \$</p> <p>(Attached explanation if amount certifies differs from the amount applied. Initial all figures on this Application and on the Continuation Sheet that are changed to conform with the amount certified.)</p> <p>ARCHITECT: By: NOT APPLICABLE Date: This Certificate is not negotiable. The AMOUNT CERTIFIED is payable only to the Contractor named herein. Issuance, payment and acceptance of payment are without prejudice to any rights of the Owner or Contractor under this Contract.</p>																										
<table border="1" style="width:100%; border-collapse: collapse;"> <thead> <tr> <th style="width:60%;">CHANGE ORDER SUMMARY</th> <th style="width:20%;">ADDITIONS</th> <th style="width:20%;">DEDUCTIONS</th> </tr> </thead> <tbody> <tr> <td>Total changes approved in previous months by Owner</td> <td style="text-align: right;">\$0.00</td> <td></td> </tr> <tr> <td>Total approved this Month</td> <td style="text-align: right;">\$0.00</td> <td></td> </tr> <tr> <td>TOTALS</td> <td style="text-align: right;">\$0.00</td> <td style="text-align: right;">\$0.00</td> </tr> <tr> <td>NET CHANGES by Change Order</td> <td style="text-align: right;">\$0.00</td> <td></td> </tr> </tbody> </table>			CHANGE ORDER SUMMARY	ADDITIONS	DEDUCTIONS	Total changes approved in previous months by Owner	\$0.00		Total approved this Month	\$0.00		TOTALS	\$0.00	\$0.00	NET CHANGES by Change Order	\$0.00										
CHANGE ORDER SUMMARY	ADDITIONS	DEDUCTIONS																								
Total changes approved in previous months by Owner	\$0.00																									
Total approved this Month	\$0.00																									
TOTALS	\$0.00	\$0.00																								
NET CHANGES by Change Order	\$0.00																									
APPLICATION AND CERTIFICATION FOR PAYMENT																										

Figure 1-22.5 Sample AIA Form G703 Continuation Sheet

CONTINUATION SHEET									
APPLICATION AND CERTIFICATION FOR PAYMENT. Contractor's signed certification is attached. In tabulations below, amounts are stated to the nearest dollar.									
APPLICATION NO: 15									
APPLICATION DATE: 13-Sep-06									
PERIOD TO: 31-Aug-06									
PAGE 2 OF 2									
A ITEM NO.	B DESCRIPTION OF WORK	C SCHEDULED VALUE	D WORK COMPLETED		F MATERIALS PRESENTLY STORED (NOT IN D OR E)	G TOTAL COMPLETED AND STORED TO DATE (D+E+F)	H % (G - C)	I BALANCE TO FINISH (C - G)	J RETAINAGE
			FROM PREVIOUS APPLICATION (D + E)	THIS PERIOD					
0100152A	INTERIM SHOP MAINTENANCE FACILITY								
033000	Cast-in-Place Concrete	2,300,000.00	1,550,000.00	150,000.00		\$1,700,000.00	73.91%	\$600,000.00	\$42,500.00
050000	Metal Fabrications	74,000.00	71,000.00	0.00		\$71,000.00	95.95%	\$3,000.00	\$1,775.00
055213	Pipe and Tube Railing	65,000.00	48,000.00	0.00		\$48,000.00	73.85%	\$17,000.00	\$1,200.00
061053	Miscellaneous Rough Carpentry	14,000.00	6,000.00	0.00		\$6,000.00	42.86%	\$8,000.00	\$150.00
072700	Air Barriers	20,000.00	0.00	0.00		\$0.00	0.00%	\$20,000.00	\$0.00
079200	Joint Sealants	20,000.00	1,000.00	7,140.00		\$8,140.00	40.70%	\$11,860.00	\$203.50
087100	Door Hardware	17,200.00	0.00	0.00		\$0.00	0.00%	\$17,200.00	\$0.00
092613	Gypsum Veneer Plastering	22,000.00	0.00	0.00		\$0.00	0.00%	\$22,000.00	\$0.00
092900	Gypsum Board	35,000.00	0.00	35,090.00		\$35,090.00	100.26%	(\$90.00)	\$877.25
095113	Acoustical Panel Ceiling	4,000.00	0.00	0.00		\$0.00	0.00%	\$4,000.00	\$0.00
099100	Painting	109,000.00	33,000.00	20,500.00		\$53,500.00	49.08%	\$55,500.00	\$1,337.50
102113	Toilet Compartments	4,000.00	0.00	0.00		\$0.00	0.00%	\$4,000.00	\$0.00
102800	Toilet, Bath, and Laundry Accessories	5,000.00	0.00	0.00		\$0.00	0.00%	\$5,000.00	\$0.00
104400	Fire Protection Specialties	2,500.00	0.00	0.00		\$0.00	0.00%	\$2,500.00	\$0.00
105113	Metal Lockers	51,000.00	0.00	0.00		\$0.00	0.00%	\$51,000.00	\$0.00
133419	Metal Building Systems	1,800,000.00	800,000.00	0.00		\$800,000.00	44.44%	\$1,000,000.00	\$20,000.00
211313	Wet-Pipe Sprinkler System	160,000.00	90,000.00	12,000.00		102,000.00	63.75%	\$58,000.00	\$2,550.00
213113	Electric-Drive, Centrifugal Fire Pumps	60,000.00	20,000.00	5,000.00		\$25,000.00	41.67%	\$35,000.00	\$625.00
220500	Common Work Results for Plumbing	95,000.00	45,000.00	5,000.00		\$50,000.00	52.63%	\$45,000.00	\$1,250.00
230500	Common Work Results for HVAC	680,000.00	\$65,000.00	\$15,000.00		\$80,000.00	11.76%	\$600,000.00	\$2,000.00
260500	Common Work Results for Electrical	3,200,000.00	1,400,000.00	\$100,000.00		\$1,500,000.00	46.88%	\$1,700,000.00	\$37,500.00
283111	Digital, Addressable Fire Alarm System	45,000.00	0.00	0.00		\$0.00	0.00%	\$45,000.00	\$0.00
GRAND TOTALS		\$8,782,700.00	\$4,129,000.00	\$349,730.00	\$0.00	\$4,478,730.00	50.99%	\$4,303,970.00	\$111,968.25

1-2207 Testing

Submittals (shop drawings, product data, product samples, catalog cuts and quality assurance submittals) for items that are not part of the Standard Specifications are submitted by the Contractor to the Designer/Architect for review and will be returned as either ‘Conforms’, ‘Conforms as Noted’, ‘Revise and Resubmit’, ‘Rejected’, or ‘No Action Required’. All remaining items are tested in accordance with established policies (i.e., concrete, HMA, subbase, etc.) in accordance with the Minimum Schedule for Sampling Materials for Test. The field inspector is then required to verify that the material installed matches the acceptable submittal. A submittal log will be kept as part of the project records.

A Final Material Certification provided by the Division Chief of Research and Materials will be required for any projects with FHWA funding or any roadway projects. A request for a Material Certificate will be sent to the DMT from the District which will include information on all the items accepted by the Designer/Architect with a statement indicating the applicable materials conformed to the Contract so that the materials can be excluded from the testing deficiency list. To assist the field inspector the following statement will be incorporated into Site Manager for materials covered by an approved submittal: “No Request for Test Required.” A Final Material Certification will not be provided by the DMT for facilities (vertical)/non-roadway projects, this information will be retained by the DMT “for information only purposes.”

1-2208 Field Design Changes (FDC’s)

A Field Design Change memorandum is used to initiate a Change Order for minor changes or revisions to the Contract. FDC’s provide direction in the form of a narrative, including sketches if necessary, so that

issues can be addressed quickly. Provided it does not affect life, safety or structural items, a Field Design Change can be issued by the District for amounts not exceeding \$10,000.00 at the level of a Supervising Engineer or above, with the concurrence of Facilities Design. There is no dollar amount limitation on FDC's from Facilities Design. However, if in the opinion of the District the changes are extensive, then a Change Order, rather than FDC, shall be issued by Facilities Design.

1-2209 Contract Closeout

The following items are required to be submitted and/or performed prior to the acceptance of a Facilities Construction Project. Detailed requirements will be found in the Special Provisions, including the "Notice to Contractor" section.

- **Warranties:** Projects include a one year general warranty furnished by the Contractor for all materials and workmanship performed under the Contract. Additionally, special warranties may be required for items such as roofs, where a 20-year or longer warranty is typical. All warranties begin on the date of issuance of the Certificate of Substantial Compliance. Contractors are required to maintain all contractually required insurance coverages through the one year general warranty period. Warranties are submitted to the Designer for review and approval.
- **Operation and Maintenance Manuals (O&M's):** O&M's are required per Special Provisions for certain mechanical, electrical and other equipment installed. O&M's are to be formatted in accordance with Section 1.20-1.08.14 of the Form 816. These manuals are submitted to the Designer for review and approval. Once approved, one copy is retained in the Project Records and all remaining copies are transmitted to the unit responsible for the operation and maintenance of the facility.
- **Spare Parts:** Many items include a spare parts schedule in the Special Provisions. Once received from the Contractor, spare parts (sometimes called extra materials, owner's stock or attic stock) are transmitted to the unit responsible for the facility. Care should be taken when storing spare parts, especially any volatile or fragile materials. For instance, paint should not be stored in an unheated room where it may freeze. Also, electrical rooms or closets cannot be used for storage.
- **Training:** Several items may require training for the end-user to ensure the proper operation and maintenance of the equipment installed. Training must be arranged in advance, but not before the relevant O&M's have been approved. Training sessions are required to be videotaped for future employees and those unable to attend.
- **As-Builts:** The Contractor is responsible for maintaining as-built record drawings and record specifications during construction and supplying a complete, "red-lined" set at the conclusion of the Project to the Engineer. The Designer may be responsible to produce as-built mylars based on the Contractor's red lines. If not, the chief inspector is responsible for updating the mylars. (Refer to Volume I Chapter 3 Section 1-314 for additional information on "As-Builts".

1-2210 Reports and Records

The Chief Inspector is required to keep all reports and records as outlined in Volume 1 Chapter 3 "Project Documentation", Volume I Chapter 10 "Contract Completion" and Volume 1 Chapter 12, "Civil Rights".

In addition a daily sign-in sheet is required, signed by the Contractor's employees and any subcontractors working on the site that day. This sign-in sheet will be attached to that day's DWR in the Volume I.

1-2211 Code Inspections Schedule

This information applies only to building structures that do not exceed the statutory threshold limit as described in C.G.S. 29-276b.

This document is based upon the 2005 Connecticut State Building Code only and does not include other governing documents such as the ConnDOT Form 816, FM Global standards and Department of Environmental Protection requirements for example. Where other governing requirements are applicable, the most stringent shall apply and shall supersede that of the 2005 Connecticut State Building Code.

This list was created for the convenience of the user and identifies most inspection situations requiring the Code Official. It is a general list and may vary based upon the nature of the building project.

The contractor shall provide the Code Official at least 48 hours notice to schedule the required code inspection and witness of testing.

Description of Inspections

- **Footing inspection Prior to Concrete Placement (Sections 1704.4, 109.3.1)**
 - Prepare fill / controlled structural fill, is site prepared per approved report and is placement of fill material compliant. (Section 1803.5)
 - Approved set of footing and foundation plans plus soil boring and sampling records shall be available at all times. (Section 106.3.1)
 - Compaction testing reported. (Section 1803.5)
 - Testing of concrete scheduled by an approved testing agency. (Sections 1704.4, 1905.6)
- **Foundation Inspection Prior to Concrete Placement (Section 1704.4)**
 - Reinforcing steel. (Sections 1704.4, 1907.0)
 - Inserts, penetrations, appurtenances and anchoring. (Sections 1604.8, 1704.4)
 - Forms placed and oiled. (Section 1905.7)
 - Testing of concrete scheduled by an approved testing agency. (Sections 1704.4, 1905.6)
 - Temporary Heat (inspected by Code Official) and Cold Weather Protection. (Sections 1905.12, 1905.13, 1905.11.1)
 - Damp proofing, Waterproofing and Subsoil Drainage System. (Section 1807.0)
- **Floor Inspection Prior to Concrete Placement**
 - Compaction Testing reported. (Section 1803.5)
 - Approved set of building plans to be available at the site. (Section 106.3.1)
 - Perimeter insulation, vapor barrier and isolation of columns. (Section 1911.0)
 - Reinforcing steel, mesh and haunch placement. (Sections 1905.7, 1907.0)
 - Slab thickness, construction joints and expansion joints. (Sections 1909.3, 1911.0)
 - Testing of concrete scheduled by an approved testing agency. (Sections 1704.4, 1905.6)
- **Underground Inspection of Mechanical, Plumbing, Electrical & Fire Protection (IMC 107.1, IPC 107.1)**
 - **Mechanical and Plumbing (IMC 107, IPC 107)**
 - Trench pitch and bedding. (IPC 306.0)
 - Piping installation and pressure test(s). (IPC 305, 312, 702, 704, IMC 1304, 1209.2)
 - Backfill material and placement. (IPC 306.3)
 - Electrical (Sections 2701, 2702, NEC 2005)
 - Trenching and bedding. (NEC 300.5)
 - Conduit installation. (NEC 300.5)
 - Backfill material and placement. (NEC 300.5(D))

- **Electrical Service Entrance and Temporary Construction Electrical Service (NEC 590.4(A), 230.0)**
 - These services shall be inspected by the Code Official and released to the respective electrical utility company for activation. Sign-off by Code Official is required by the Utility Companies.
- **Fire Protection - Underground work including fire service and thrust blocking. (NFPA 13 - 2002, Chapter 10, 10.8.2 (thrust blocks))**
 - Trenching and bedding. (NFPA 13 - 2002, 10.4 – 10.9)
 - Piping installation and pressure test(s). (NFPA 13 – 2002, 10.10.1 – 10.10.2.24)
 - Backfill material and placement. (NFPA 13 – 2002, 10.9)
- **Fuel Storage Tank(s) Underground (UST) and Aboveground (AST) Installation (IMC 1301.2, CT Flammable & Combustible Liquids Code, NFPA 30 – 2002 Ch. 2 & 3, CT Oil Burning Equip. Code, NFPA 31 – 2002 Ch. 2 & 3, CT Gas Equipment & Piping Code, NFPA 54 – 2002 Ch. 2, 3, 4, CT LP Gas & LN Gas Code, NFPA 58 – 2002, Ch. 2, 3, 5)**
 - Witness of all manufacturers' required procedures.
 - Hold down structures
 - Backfill material and placement.
 - Piping and appurtenances and testing.
- **Structural Steel & Metal Framing Inspection Prior to Concealment**
 - Inspection shall be performed by Special Inspector or Code Official if Special Inspector is not required.
 - Protection of steel by approved methods prior to masonry. (Section 2203.2)
 - Floor, roof and wall members, panels, columns, bracing, bolts, washers and welds. (Sections 1704.3, 1704.3.1.2, 1704.3.3)
 - Spray applied fire resistive material. (Section 1704.11)
 - Third party reports: prefab steel, assemblies, markings, certified test reports, ASTM, weld filler. Fabricator Certification / Quality Control Procedures. (Sections 1704.2, 1704.2.1, 1704.2.2)
- **Masonry & Stone Inspection Prior to Concealment (Sections 1704.5, 2104.1)**
 - Anchor ties. (Sections 1704.5, 2104.1.3, 2109.7)
 - Lintel and bond courses. (Sections 1704.5, 2104.1.5, 2109.6)
 - Horizontal and vertical reinforcement. (Sections 1704.5, 2109.6)
 - Certification of block, brick and accessories. (Section 1704.5)
 - Mortar type material, temperature and method of application. (Sections 1704.5, 2104.3)
 - Flashing, dampproofing, weeping, wicking, insulation and penetrations. (Section 1704.5)
 - Third party reports, prefab masonry units, assemblies, markings, certified test reports and ACI Standards. (Section 1704.5)
 - Temporary Heat and Cold Weather Protection (Sections 1704.5, 2104.3.3)
- **Wood Construction Roughing Inspection**
 - Fabricator Certification / Quality Control Procedures. (Sections 1704.6, 2303.0)
 - Material Grading. (Section 2303.1.1)
 - Connections. (Section 2304.9)
 - Framing and Details. (Sections 2304.3, 2304.4)
 - Roof and Floor Diaphragms, Interior and Exterior Shear Walls. (Sections 2305.2, 2305.3)
- **Cast-In-Place Concrete, Pre-Cast Concrete, Exterior Insulation & Finish Systems (EIFS), Structural Insulated Panel Systems, Curtain Wall Systems and all Special Cases (Sections 1903, 1704.4, 3101.1), Mechanical, Plumbing, Electrical & Fire Protection (including Sprinkler Standpipe, Hood Extinguishing, Detection and Fire Alarm) Above Slab / Rough-In Inspection Prior to Concealment**
 - Rough-in inspections shall be made after the roof, framing, fireblocking, firestopping, draftstopping and bracing is in place and all ducting and other components to be concealed are complete, all sanitary, storm, fire protection and water distribution piping is roughed-in & prior to the installation of wall and ceiling coverings.

- Inspections of MEP & FP work shall also include inspection of fire safing, sleeving, sealants, penetrations & thru-penetration firestop systems as well as seismic bracing and attachment (which may be a part of Special Inspection duties)
- **Mechanical and Plumbing (Sections 2801.1, 2901.1, IMC 107(2))**
 - Piping and duct system installations. (IMC 304, 603, 1107, 1208.1, 1304, 1305, IPC Ch. 6 & 704)
 - Duct and piping support, hanger systems and seismic bracing. (IMC 304, 305, 603, IPC 308, 1621)
 - Fire and smoke dampers. (IMC 716.1, 716.3, 716.5, UL 555, NFPA 90A – 2002)
 - Pipe / duct insulation, identification, valve tags and vibration isolation. (IMC 301.10, 604, 1204, IPC 303, 505, Ch. 6, 719.7)
 - Witness piping system (domestic water, drain-waste-vent, storm, fuel) testing. (IMC 107.2, 1208, 1209.2, 1304.1, IPC 312)
 - Witness refrigerant system test and certification provided. (IMC 1108)
- **Electrical (NEC 2701.0)**
 - Rough-in inspection shall include but not be limited to:
 - General requirements for electrical installations, conduit and feeder installation. (NEC Art. 110)
 - Bonding and grounding of devices, boxes, conduit, equipment and structure. (NEC Art. 250)
 - Service entrance and switchgear installation. (NEC 110.34F, 230, 338, 490 III)
- **Fire Protection**
 - Rough-in inspection shall include but not be limited to:
 - Piping system installation. (Section 903.0, NFPA 13)
 - Hanger systems and seismic bracing. (Section 903.0, NFPA 13)
 - Witness hydrostatic pressure system test. (Section 903.0, NFPA 13)
- **General Inspection (Sections 109.3, 705.0, 706.0, 708.0, 709.0)**
 - This section shall also be done on fire walls, fire and smoke barriers constructed in accordance with referenced test assemblies.
- **Inspections & Testing Prior to Certificate of Compliance and Occupancy (Sections 109.0, 110.0)**
 - Outstanding inspection report violation findings and code discrepancies resolved. (Sections 109.3.10, 113.0)
 - Outstanding Plan Review report comments and code discrepancies resolved. (Sections 109.3.10, 113.0)
 - Testing of the emergency power and standby power systems - witnessed by CA & Engineer of Record. (Sections 2702, NEC 700.4, NFPA 110 – 2002)
 - Testing of fire protection systems. (sprinkler, standpipe, hood and special extinguishing, fire pump, detection & fire alarm systems), special locking area of refuge communication system, emergency lighting and exit signage witnessed by Code Official. (Sections Ch. 9, 1011, 1024, NEC 700, 760, 1021.4)
 - State of Conn. Dept. of Public Safety - Boiler Bureau inspection, testing & operating certificate (860) 685-8320 where applicable. (CT General Statute Chapter 540)
 - State of Conn. Dept. of Public Safety - Elevator Bureau inspection, testing & operating certificate. (860) 685-8340. (Section 3001.1.1)
 - State of Conn. Dept. of Public Health (DPH) approval of sewer, septic and water supply (potability test per IPC 610) Kitchen / food service per Local or Regional Health Department.
 - State of Conn. Dept. of Environmental Protection registration of fuel oil, motor and aviation fuel and hazardous materials, Engineer of Record to complete required form for CTDOT to sign.
 - Backflow prevention acceptance by water supplier. (IPC 608)
 - Certification of HVAC operation and balancing. (IMC 107.2)
 - Testing of smoke control system - witnessed by Code Official & Engineer of Record. (Section 909.3)

- Electrical Ground Fault Protection system performance test, witnessed by Code Official. (NEC 230.95C)
- Kitchen Hood exhaust system, laboratory hood and special exhaust system inspection and testing by certified installer / tester, and witnessed by the Code Official. (IMC 507, 510, NFPA 45)
- Explosion Hazard Protection Inspection by Engineer of Record. (Section 414)
- Inspection of accessible components by Code Official and Engineer of Record. (Chapter 11)

Figure 1-22.6 Certificate of Compliance

CERTIFICATE OF COMPLIANCE	
Location :	
Description:	
Town :	
Permit Number :	Project Number :
<p>THIS IS TO CERTIFY THAT to the best of my knowledge and belief , the above described project has been designed in substantial compliance with the requirements of the State of Connecticut Basic Building Code and other applicable codes as required by Section 29 – 252(a) of CGS as amended . Minor deficiencies and approved variances are indicated below :</p>	
_____ Engineer of Record	_____ Date
<p>THIS IS TO CERTIFY THAT to the best of my knowledge and belief , the above mentioned project was built in accordance with the plans and specifications and approved change orders, and is in substantial compliance with the Connecticut Building Code and all other applicable codes. Special stipulations are noted below :</p>	
_____ General Contractor	_____ Date
_____ D.O.T District Engineer	_____ Date
_____ D.O.T Trans. Principal Engineer Philip E. Parcak – B.O. 017 – 90	_____ Date
Received by State Building Official :	
By :	Date :

Chapter 23 - Value Engineering Change Proposals (VECP)

1-2300 General

The Department has a Value Engineering provision within Division 1 of the *Standard Specifications* wherein a Contractor may propose changes to a project of any size for improvement to the project's performance, value and/or quality, lower construction costs, or shorten the delivery time, while considering impacts on the project's overall life-cycle cost and other applicable factors. Article 1.09.02 specifies the minimum cost savings amount and other criteria necessary for a Value Engineering Change Proposal (VECP) to be approved by the Department.

1-2301 Department Responsibilities

1-2301A VECP Analysis

The Department reserves the right to decline, to review, or to reject after initial review, any VECP. Before expending considerable funds in development of a formal VECP, the Contractor is required by the *Standard Specifications* to submit a conceptual Proposal to the Department.

Conceptual Proposal:

- Value calculated in costs noted should be the minimum in accordance with the standards.
- The Office of Construction's (OOC) VE Coordinator should be involved early in the process and can provide a good resource for walking through the analysis.
- The conceptual proposal should include the [VECP Form](#) (including the VECP Checklist) and the following minimum information:
 - A statement that the proposal is submitted as a Value Engineering Change Proposal
 - A description of the difference between the existing contract requirements and the proposed change
 - A brief comparative of the advantages and disadvantages, including considerations of service life, economy of operations, ease of maintenance, desired appearance and safety
 - When an item's function or characteristics are being altered, a justification of the effect of the change on the end item's performance must be included.
 - A statement of the time in which the proposal must be executed so as to obtain the maximum cost reduction. This date must be selected to allow the Department ample time for review and processing.
 - A statement as to the effect the proposal will have on the time for completion of the contract.
- Any proposed VECP that includes contract time savings as part of the VECP's monetary value calculation should be very carefully analyzed to determine if the reduced contract time is an appropriate element for VECP. This analysis should consider the following:
 - The VECP must include specific changes to required contract elements that will directly result in the reduction of contract time. Simple acceleration of work or completing the project earlier is NOT to be considered for VECP.
 - Changes to the Contractor's means and methods, which may result in earlier completion of Project, is NOT to be considered for VECP since the means and methods are already at the Contractor's discretion and therefore do not require a change in the contract. Unless the contract directs the use of specific means and methods, then a submission of this type can be considered.

- Often the original contract time established in the contract provides more time than what is strictly necessary to construct. By providing more contract time, the Department can encourage lower bids by offering more schedule flexibility. When considering a VECP with contract time savings, the Department should determine if an earlier completion is indeed a “value” to the Department.
- Remember if time was important to the project during the project development an “Incentive/Disincentive” Specification would have been originally included.
- If a Contractor is trying to recover time due to a design or other contract time delays the submission of “acceleration” to recapture time will not be considered a VECP.
- If the Department determines that the time saving element of the VECP is not specifically acceptable, then the Contractor should be so advised and offered the opportunity to revise their VECP without the time savings element.

Final Proposal:

- The [VECP Form](#) and VECP Checklist shall be used in the evaluation of a final submission from the Contractor.
- The Department should anticipate if a VECP is accepted what are the possible “road blocks” that could affect the VECP, such as:
 - Will the VECP introduce a potential for Differing Site Conditions? Unforeseen Conditions? Extension of Contract Project Limits? ROW Concerns?
 - Impedance to prior commitments made to “Stakeholders”.
 - For example: Has considerable time been committed by the Department regarding staging and coordination with the local residents?
- If contract time savings is part of a VECP, the Contractor should also provide a schedule clearly showing the VECP will be on the critical path to contract completion.

1-2301B VECP Acceptance or Rejection Procedures

Once the Contractor is considering a VECP the Project Engineer (PE) shall forward the VECP Request Form for their use and information. The Contractor submits their VECP Request form and their conceptual plan. The PE reviews the conceptual submission using the VECP Checklist, Article 1.09.02, and the points detailed above. If the District staff finds the conceptual VECP submission has merit it should be forwarded to the Value Engineering Coordinator in the OOC for review and comment. The Value Engineering Coordinator will coordinate with the Lead Design Team to review and comment on the conceptual submission. The District will review the comments from OOC and the Designer to determine if the conceptual submission has merit.

If a conceptual submission is rejected at any time the District should notify the Contractor by letter with the OOC copied on the correspondence.

If a conceptual submission has merit, the Contractor should be notified in writing by the District and encouraged to submit a formal VECP package. The Contractor’s VECP package, along with the VECP Request Form and any pertinent backup documentation is then forwarded from the PE to the District Engineer (DE) and then to the OOC’s Value Engineer Coordinator. The VE Coordinator will get input from the project’s Designer(s) and FHWA (if applicable) and return the comments to the District Project Staff along and a copy to the District Liaison Engineer for their use.

If the proposal is rejected by the Construction Administrator, the District Office will forward the rejected proposal and letter to the Contractor. If additional information is required, the Contractor will be informed in the letter whether resubmission of the entire updated VECP submittal is needed or supporting

documentation is required to substantiate the original proposal for further consideration. All proposals and documentation must be submitted in a timely manner.

If the proposal is accepted by the Construction Administrator, the District Office will forward an acceptance letter to the Contractor. The acceptance letter should specify the Department's estimate of the anticipated savings from the VECP. VECPs that contain a time element should specify that the costs associated with time will be reimbursed when the final time can be validated.

The approved proposal will be distributed from the OOC to the District and incorporated into the contract by project staff in a Construction Order. Payments will be made as outlined in Article 1.09.02.

Copies of the fully executed VECP form or, if applicable, the letter listing the reasons for the rejection will be retained in the OOC and the project records.

The VECP Request Form and the VECP Checklist can be found with the Approved Forms in ProjectWise. (Documents - 04.1 - Construction Libraries - 04.200 - Approved Forms and Inspection Checklists)

1-2302 Incorporation of Accepted VECP into Contract

Construction Orders that involve Value Engineering Change Proposals will follow the guidance in Article 1.09.02 to reflect the changes in unit bid item quantities or new agreed price items, as appropriate. A VECP cost reduction incentive item (Lump Sum) should be created representing 50% of the estimated total savings (the Contractor's share) as a result of the implementation of the approved VECP. The Standard Explanation Classification to be entered is 5-O, Other Adjustments. The VECP cost reduction incentive item must go into the Construction Order as Item Code VECP001, VECP002, etc. Payments will be made to the Contractor under this item as outlined in 1-2303.

Each VECP cost reduction incentive item must be incorporated into the contract in a separate Construction Order and will have the VECP Request Form with approval signatures and backup documentation package in the Addendum.

1-2303 VECP Payments

On State Funded Projects ONLY: After the VECP has been approved *in writing* by the Department, the District and the Contractor can negotiate a cost reduction incentive payment schedule. An initial payment may be made to the Contractor for start-up costs associated with the VECP.

When the implementation of the VECP, including all related construction, has been completed, the project staff will calculate the actual savings that resulted from it. Half of the actual savings will be paid to the Contractor in accordance with Article 1.09.02.

When the approved VECP contains a contract time savings, the Department will determine the value of the contract time savings achieved by multiplying the actual contract days saved (per the VECP) by the amount of the liquidated damages for one day under the Contract. The actual contract days saved shall be determined by the Department by comparing critical path schedules of the completed work using the VECP to a schedule without the VECP.

Figure 1-23-1 Sample VECP Payment Calculation**Example VECP Payment Calculation:****Step 1: Calculate Estimated Savings**

VECP Estimated Savings = \$1,200,000.00

Contractor's share = $\$1,200,000.00 \div 2 = \$600,000.00$ **Step 2: Create VECP cost reduction incentive item**

New Item: VECP01 'Description of Work'; LS \$600,000.00

***Step 3 (Optional): At discretion of District, make up front payment for start-up costs associated with the VECP** $\$600,000.00 \times 0.25 = \$150,000.00$

*Note: This may only be a consideration on a State Funded Project.

Step 4: Calculate Actual Savings

Based on Original Contract Item Quantities less New Agreed Price Items or Original Items Bid Prices with revised Item Quantities

Actual savings calculated by project staff = \$1,040,000.00

Step 5: Make Final Payment to Contractor $(\text{Actual Savings} \div 2) - \text{Initial Payment}^* = \text{Final Payment}$ $(\$1,040,000.00 \div 2) - \$150,000.00 = \$370,000.00$

Appendix A - SiteManager 3.15a User Guide

TABLE OF CONTENTS

Section One - Logging onto SiteManager 3.15a

Introduction A-1.3
 Getting Started A-1.3
 Remote Desktop Connection Logon A-1.3
 SiteManager Logon..... A-1.4
 Entering SiteManager A-1.5
 Exit Remote Desktop A-1.6

Section Two - Daily Work Reports

Daily Work Reports (DWRs) A-1.6
 Add Contractor Personnel for DWRs A-1.7
 Add Contractor Equipment for DWRs A-1.7
 Create a Daily Work Report (DWR) A-1.8
 DWR Information A-1.9
 Contractors A-1.11
 Contractors Equipment A-1.11
 Daily Staff A-1.12
 Work Items..... A-1.13
 Force Accounts A-1.14
 Open an Existing DWR A-1.14
 Copy an Existing DWR A-1.15
 Review a DWR A-1.15
 Mobile Inspector Application A-1.15
 Updating Contract Authority A-1.15

Section Three - Daily Diaries

Diary A-1.17
 Create a Diary A-1.17
 Enter Information on a Diary A-1.17
 Charge Days A-1.19
 Review and Authorize a DWR (in the Diary) A-1.19
 Diary Adjustments A-1.20

Section Four - Contract Estimates

Installed Work Report A-1.20
 Generate an Estimate A-1.20
 PDF Print an Estimate A-1.21
 Approve an Estimate..... A-1.21
 Contract Adjustments..... A-1.22
 Contract Adjustments for Pavement A-1.22
 Line Item Adjustments A-1.22
 Liquidated Damages A-1.23
 Creating a New Stockpile A-1.23

Section Five - Sampling and Testing

Materials Testing (MAT-100) A-1.25
 Contract Item Materials Report A-1.25
 Create a MAT-100 A-1.26
 Basic Sample Data A-1.26
 Additional Sample Data A-1.28

Contract A-1.28
Tests A-1.29
PDF Print a MAT-100 A-1.30

Section Six - Construction Change Orders

Create a Change Order A-1.35
Change Order Items A-1.36
Create a New Contract Item..... A-1.36
General Change Order Explanations A-1.37
Specific Change Order Explanations A-1.37
Standard Explanation (Specific Items) A-1.38
Standard Explanation (All Line Items) A-1.38
Specific Text Explanations (Specific Items and All Line Items) A-1.39
“No Item” Change Order A-1.40
Header A-1.40
Change Order Explanations A-1.41
Change Order Approval A-1.42
Change Order Reports A-1.42

Section Seven - Labor Wage Checks

Labor Wage Checks A-1.43
Enter New Labor Wage Checks..... A-1.43
Modify or Review Existing Labor Wage Checks A-1.44

Section Eight - Contractor Payrolls

Entering Payroll Information A-1.44
Enter Additional Payrolls for the Same Contractor A-1.45
Enter Certified Payrolls for a Different Contractor..... A-1.45
Deleting a Payroll A-1.45

Section Nine – Contractor Ratings

Contractor Ratings..... A-1.46

Section Ten – Subcontractor Approvals (Office of Construction)

Subcontractor Approvals A-1.47

Section Eleven – New Contracts in SiteManager (SM Administrators)

Importing a New Contract into SiteManager A-1.49
Contract Activation A-1.49
Municipal Contracts A-1.49

Section Twelve – Contract Finalization (SM Administrators)

Contract Finalization A-1.60

Section One – Logging Onto SiteManager 3.15a

Introduction

This manual has been written to standardize methods for entering information into the construction management system software, **SiteManager 3.15a**. It provides step-by-step navigation through the menus, data entry requirements for project staff, and various tips. State policy has been incorporated into applicable areas.

Basic computer operating skills are assumed.

The Office of Construction (OOC) SiteManager Administrator is charged with the administration, support and oversight of the SiteManager application and its associated functions. In addition, the OOC SiteManager Administrator is charged with establishing and overseeing the business uses of the application in the administration of the Department's contracts. In addition, there are staff members within each District and the DMT, who are assigned to support the SiteManager system. These personnel are available to assist unit staff with SiteManager questions or problems. Should you require assistance with your user account or other SiteManager support issues, it is requested that you email your District or DMT representative and cc: the Office of Construction administrator. A list of District and DMT representatives is included at the end of this document.

Employees who are no longer a DOT employee should have their profile de-activated by the District Representative. If they need to use SiteManager in the future while working for a consultant, a new profile should be created.

Getting Started

In order to start using SiteManager, there are two different areas necessary for logging onto the system. The first area procedure outlines logging onto the **Remote Desktop Connection**, and the second outlines logging onto **SiteManager**.

Remote Desktop Connection Logon



On the computer desktop, double click the **Remote Desktop Connection** Icon.

(This icon was previously labeled as **SiteManager** a few years ago. If the computer desktop still has it, it is obsolete.)

To place this icon on your desktop, click the **Start** button, single click **Remote Desktop Connection**, and drag to the computer desktop.

Double-click the icon, and the **Remote Desktop Connection** window will open.

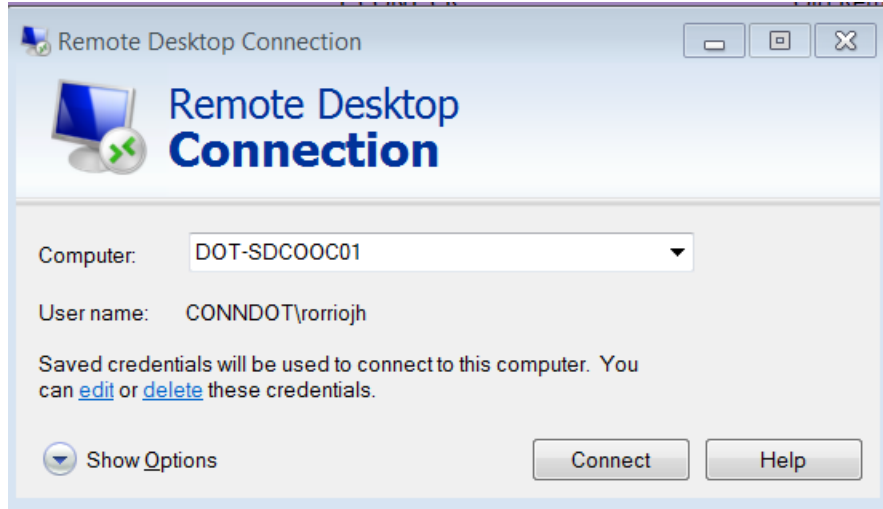

(Note: when you logon for the first time, you have to manually enter ‘DOT-SDCOOC01’, ‘DOT-SDCOOC02’, ‘DOT-SDCOOC03’ or ‘DOT-SDCOOC04’, depending on your District, in the **Computer:** field. The last two numbers in the server name correspond with the users’ District number.

(Including the backup, District 1 and District 2 personnel may use server 01 or 02. District 3 and 4 personnel may use server 03 or 04.)

- Click the **Connect** button.

A server desktop will open with the computer name listed within a tab on the top of the screen.

- The **Log onto Windows** window will open.
 - Enter your **User Name** and **Password**. (Note: Your user name and password will be the same as your log-in information for your desktop computer.
 - Here you will see one of two screens. One screen will contain two icons: one with the domain and username (CONNDOT\username) or one with a user name and password field.
 - If the **Log on to** field contains anything other than **CONNDOT**, choose the “Other User
 - Click the **OK**

You will now be working on the **Remote Desktop Server**. This desktop will look similar to your local desktop and has all of the same functionality. The difference is that you will actually be working on a computer in a different location, and not on your local PC.

If you are having problems signing into the **Remote Desktop Server**, please email or call the Helpdesk, DOT at 860-594-3500. This userid and password is the same as your Windows login. Unlike the **SiteManager** password, the district SM representatives and the OOC SM representatives are not able to reset this password.

SiteManager Logon

Look for the **SiteManager 3.15a** and **SiteManager Reporting** icons.

NOTE: SiteManager LIMS is not being used.

- Double click the orange **SiteManager 3.15a** icon. This will take you to the SiteManager Application logon

screen. The **SiteManager Logon** window will open.

- Enter your **User ID** that was provided to you by your SiteManager District Representative.
- Generally, your **User ID** will be the first six characters of your last name followed by the first initial of your first name. All characters will be in lower case.

1. Upon your initial logon to SiteManager (or whenever your password is reset), your password will temporarily be '**PASSWORD**' (enter as all capitals – SiteManager is case sensitive).

- Enter '**PASSWORD**' in the Password field. (At this point, the **I Agree** button will be grayed out.)
- Click the **Change Password** button.

The **Change Password for User ID** window will open.

- Enter '**PASSWORD**' as your old password.
- Enter and confirm your new password (the new password must be 4 to 8 characters or digits).
- Click **OK**.

Note: no form of the word 'password' is allowed.

2. Subsequent logons require you to use your new password

(Type your password exactly as entered. Remember that SiteManager is case sensitive.)

- Enter your password.
- Click the **I Agree** button.
-

DO NOT SHARE YOUR USERID AND PASSWORD

TIPS

- ❖ SiteManager Security will lock the system after three consecutive logon failures.
- ❖ Always close and restart the logon screen after two failed attempts.
- ❖ You may change your password as often as you desire.
- ❖ If you forget your password or get locked out, email your SiteManager District Administrator and cc: the OOC SM Administrator.
- ❖ If your User ID is not found, make sure it was input in lowercase – SiteManager is case sensitive, otherwise, check with your SiteManager District Representative.

Entering SiteManager

The **Available Groups for User ID** window will open.

Depending on your role, you will have a number of different groups to choose from. The most common groups are:

- Site Manager Inquiry (no changes can be made)
- Inspector
- Project Manager (Chief Inspector)

Select how you wish to enter SiteManager by highlighting the appropriate **Group Name**, and then click **OK**. The **SiteManager Panel** window will open.

NOTE: Each group has specific rights. Choose the one that applies to the tasks you wish to perform.

In order to avoid possible errors, always choose the group with the lowest level of rights available.

Exit Remote Desktop

To sign out of **Remote Desktop**, click **Start** and then click **Log off**. Do not click the **X** in the upper right hand corner of the screen to sign out.

Section Two – Daily Work Reports

Daily Work Reports (DWRs)

This section outlines the procedures for entering information into the **Daily Work Report**. **The minimum requirements for information to be documented by the DWR are outlined in the Construction Manual.**

It is strongly recommended that you review the entire section related to DWR's prior to entering one. If you are looking for specific information, the subsections that follow are divided by topic.

It is advisable to select your contract upon entering SiteManager:

- Double click the **Contract Administration (+)** icon.
- Double click the **Contract Records (+)** icon.
- Double click the **Contracts (or Projects)** icon.
- Click the **File** pull-down menu, and then click **Open**. The **Select Contract** window will open.
- Double click your appropriate **Contract ID**.

All tasks will apply only to the selected contract.

- Click the **SiteManager Panel** icon (or click the **File** pull-down menu, then click **Main Panel**) to reopen the **SiteManager Panel**.

The following icons are available on the SiteManager **Main Panel** Icons with a (+) next to them will open a new panel when selected:

- Contract Administration (+)
- Daily Work Reports (+)
- Contractor Payments (+)
- Change Orders (+)
- Civil Rights (+)
- Materials Management (+)
- Accessories (+)

A **Daily Work Report** is required only when there is construction activity (contract work being performed).

A **Daily Work Report** may be created for a 'No Activity' day to make item payments. (For example, to pay for a project field office during a winter shut-down period.)

Inspectors compile their daily DWRs by entering a comprehensive description of the work that took place that day into the SiteManager DWR.

Add Contractor Personnel for DWRs

The Project Manager (Chief Inspector) is responsible for adding the equipment and labor classes that each Contractor will be using on the Project, as well as the personnel assigned to the project to represent the DOT, to the ‘Personnel Type’ pull down menu. The initial population of the lists should be done prior to the need for DWR entry. It is also advisable to maintain the list throughout the project.

Navigation to add personnel is:

- Starting at the **Main Panel**, Double-click on the **Daily Work Reports (+)** icon.
- Double-click on the **Reference Tables (DWR+)** icon.
- Double-click on the **Contract Master List** icon. The **Select Contract Vendor** window will open.
- Double-click the desired contract.

A list of contractors (vendors) will appear.

- Double-click on the contractor that you would like to add personnel to. The **Contract Master List** window will open and the **Equipment** bullet will be active.
- Click the **Personnel** bullet.
- Highlight a title under the **Personnel Name** column.
- Click **Add** to transfer the personnel type from the Vendor Master List to the Contract Vendor List.
- Repeat the steps until all personnel are added.
- Click the **Save** icon.
- Click the **Open Folder** icon to open the **Select Contract Vendor** window.
- Select a new contractor, and add personnel by following the steps above.
- When all personnel has been added to the project, click the **Save** icon and close the window.

You will now be back at the **Contractor** tab within the DWR.

- Click the **New** icon. A pull down menu will appear.
- Select a personnel type by clicking the down arrow and highlighting a classification.
- Enter the number of each personnel type, and their hours worked.

SiteManager will compute the total hours and transfer them to other fields on this screen.

After all information has been added relating to the **Contractors** tab, click the **Save** icon.

Note: You only have to add or remove DOT representatives in the “Staff Member” list once. It is not necessary to do it under every contractor, although it may be best to choose the prime contractor for this list.

Add Contractor Equipment for DWRs

At the start of the project, the Project Manager is responsible to add and maintain the equipment that each contractor will be using on the Project to the **Equipment ID – Description** pull down menu: **Navigation to add equipment is:**

- Starting at the **Main Panel**, Double-click on the **Daily Work Reports (+)** icon.
- Double-click on the **Reference Tables (DWR+)** icon.
- Double-click on the **Contract Master List** icon. The **Select Contract Vendor** window will open.
- Double-click the desired contract. A list of contractors (vendors) will appear.
- Double-click on the contractor that you would like to add equipment to.

The **Contract Master List** window will open and the Equipment bullet will be active.

- Highlight a title under the **Equipment Description** column.
- Click **Add** to transfer the equipment type from the **Vendor Master List** to the **Contract Vendor List**.
- Repeat the steps until all equipment is added.
- Click Save.
- Click the **Open** Folder icon to open the **Select Contract Vendor** window.
- Select a new contractor, and add equipment by following the steps above.
- When all equipment has been added to the project, click Save and close the window.

You will now be back at the **Contractor Equip.** tab within the DWR.

- Click the **New** icon. A pull down menu will appear.
- Select an equipment type by pressing the down arrow and highlighting a classification.
- Enter the number of each equipment type, number used, and hours used.
- After all information has been added relating to the **Contractors Equip.** tab, click **Save**.

NOTE: If a particular personnel or equipment type is unavailable from the master list, please contact your District SM representative.

Create a Daily Work Report (DWR)

- To select your contract, click the **Main Panel** icon.
- Click the **Main Panel** tab.
- Double click the **Daily Work Reports (+)** icon to open the Daily Work Reports (+) menu.
- Double click the **Daily Work Reports** icon to open the **Daily Work Reports** window.
- Alternatively, if a DWR is open and being reviewed, the user can create a new DWR by selecting either **File -> New** or by clicking on the **New** icon in the tool bar.
- The **DWR Info.** tab will be active, and the current date will be shown.
- From the Menu, choose **Services->Choose Keys**. A new window will open.
- Single click on the **CONTRACT ID** header. This will sort the Contracts in numerical order. Once this is done, the contracts can either be browsed using the scroll bar or the specific **Contract** number can be typed in the **FIND** text box.
- Once the desired contract is selected, simply double click or click **OK**.

Alternatively, if a **Diary** is already open and being reviewed, the user can create a new **Diary** by selecting either **File -> New** or by clicking on the **New** icon in the tool bar.

In order to select a different contract, the user must select **File -> Open** or click the **Open Folder** icon on the toolbar. The same process for selecting a contract is followed.

Note: The Contract must be selected prior to creating the DWR. If the box in the upper left hand portion of the screen is blank, then the contract has not been selected yet. You must do so before proceeding.

Note: Be careful that you do not accidentally create or save a DWR on the wrong project or for a day with no activity

If there is no activity for the date shown, a DWR is not required. DWRs created accidentally cannot be deleted.

- Double click on the **DWR Date:** field. A calendar will open with the current date highlighted.
- Click the desired **DWR** date, and click **OK**. You may also put the cursor in the date field and manually input the six-digit date.

There are six sections that comprise a **Daily Work Report (DWR): DWR Info., Contractors, Contractor Equip., Daily Staff, Work Items, and Force Accounts.** The **Force Accounts** tab is not currently being used, but the rest are mandatory.

DWR Information

- Input the high and low temperatures.
- Select the morning and afternoon weather conditions using the pull down menus.

SiteManager will automatically check the following boxes: **No Work Items Installed:, No Contractors On Site:, and No Daily Staff On Site:.** SiteManager will automatically update the status of the checks for these fields based on information that is entered in the balance of the DWR.

- If applicable, check the **Work Suspended:** box, then enter the appropriate times.

The following examples are recommendations for entering information within the **Remarks:** fields: (Note that when information is saved in any of the categories mentioned below, a green check symbol will appear next to that category description.)

There are three scenarios for entering information within the **General** category:

1. Project Manager, with or without sub-inspectors, no activity and with payments:
General No Contractor Activity: Prime Contractor to Project 123-123
 Schilling, C.: Review Cost Plus
 Smith, R.: Testing
 McGraw, T.: Volume III Computations
 Phone call to DOT Design, RE: plantings.
 Make monthly payment for project field office.
2. Project Manager with no sub-inspectors, with contractor activity:
General Waters Construction – East St. – drainage
 CCA – East St. – construction staking
 Santoro – East St. – saw cutting
 Conn. Traffic Control – East St. – traffic control
 Phone call to DOT Design, RE: plantings
 Issue speed memo to prime, RE: turf est. required for slope stabilization.
3. Project Manager with sub-inspectors and contractor activity:
General See DWR MMDDYY morrisk for end-of-month payments.
 See DWR MMDDYY smithr for saw cutting and utilities
 See DWR MMDDYY ginnng for drainage, traffic control and staking.
 Phone call to DOT Design, RE: plantings.
 Issue speed memo to prime, RE: turf est. required for slope stabilization.

The following examples are recommendations for entering information within the remainder of the **Remarks** fields:

(Note: Categories can be left blank if there are no relevant comments. Information is only required if it pertains to significant events that occurred on the project.)

Accident West Street, NB lane 1030 +/-, car vs. truck, Town police on scene.

Compliance Notice	Silt fence has been repaired at Sta. 33+00
EEO Issues	30% EEO site meeting rescheduled for next week
Environmental	Sed. fence adjacent to field office undermined by runoff from noon thunderstorm. Contractor repaired before the end of work.
Lane Closures	South Street closed, detour in effect. East Street alternate one-way, station 0+120 to 0+200, 0700-0930.
Meetings	Utility Meeting with T.R. James Construction, Yankee Gas, and Conn DOT. See minutes.
Non-Compliance Notice	Class F Concrete placed at Retaining Wall 102 has failed the 28-day strength requirement.
Personnel Remarks	Only note staff present. Do <u>not</u> include staff on leave or leave type.
PE Record Review	Project Engineer on site: Review volume 1.
Possible Cost Plus	During saw cutting of roadway for drainage installation, found concrete roadway (cutting of concrete roadway item to be added). Refer to hard copy DWR for labor and equipment.
Possible Dispute or Claim	Discussion with contractor – item #0406013 (qty increase over 125%).
Railroad Force Account	Not used at this time
Safety Violations	Prime Contractor instructed to protect drop-off along edge of sidewalk.
Trafficperson	Claypool 0800 to 1530 (no lunch)
Utility CON-40 Info	T. R. James Construction for Yankee Gas relocating gas line 0900-1400 South Street, station 1+040 to 1+080, right. Refer to hard copy DWR for men, equipment and CON-40 #.
Visitor	Mr. Haynes, Public Works Dept. Mr. Leary, Project Engineer
Weather	Heavy winds and thunderstorm from 1200-1230
Work Hours	Garcia Construction Co.: 0630-1430 CCA: 0900-1600 Santoro: 0900-1200 Conn. Traffic Control: 0630-1600 Brockie, D.: 0700-1430 Cornell, C.: 0630-1200 Tyler, S.: 0800-1600

TIPS

- ❖ All DWR's must be referenced by the applicable User ID. For example, a DWR for July 8, 2015, by an inspector named Jeff Pinkus, would be "DWR 070815 pinkusj".
- ❖ DWR attachments must also be fully labeled. For example, an attachment to the above would be labeled "DWR 070815 pinkusj-1". Back-up for that page would be "DWR 070815 pinkusj-1a". If there were another attachment (a speed memo or a wholly separate computation), it would be "DWR 070815 pinkusj-2".

Contractors

When the **Contractors** tab is active, there are three areas to input information: **Contractor**, **Supervisor/Foreman Name**, and **Personnel Type**. The only area that is required to be filled is the **Contractor** field. SiteManager will not allow items to be entered in the Work Item tab unless there is a contractor associated with the DWR. Be sure to select the correct contractor that is associated with the work. This helps with tracking items that are specifically assigned to contractors, such as **DBE** contractors. Items that are assigned to other contractors will **NOT** be paid under the prime contractor.

No personnel will be available for DWRs until they are added to the master list by the Project Manager. See above, for navigation.

- Click anywhere in the **Contractor** area to highlight it. You will see a shadow line on the right side and bottom of the active area.
- Click the **New** icon. A dropdown menu will appear. Select a contractor by pressing the down arrow and highlighting the contractor. Do not enter information in the columns on the right. SiteManager will update these fields as you input information. Click anywhere on the **Personnel Type** area to highlight it.
- Click the **New** icon. A dropdown menu will appear. Select a personnel type by pressing the down arrow and highlighting the title.
- Enter information in the **Nbr of Persons** field.
- Enter information in the **Hours Worked** field.
- Click the **New** icon to add more personnel types.
- Click Save.

NOTE: If the name of the supervisor/foreman does not appear in Contract Master List for a particular vendor, then contact the District SiteManager Representative to have the Supervisor/Foreman name entered for your project.

NOTE: Each particular personnel type (i.e. laborer) can only be entered once per DWR. Therefore, if you have more than one particular personnel type and they work a different number of hours that day, you would need to enter a remark to record their separate work hours.

Contractors Equipment

When the **Contractor Equip.** tab is active, there are two areas to input information: **Contractor** and **Equipment ID – Description**.

No equipment will be available for DWRs until added to the Master List by the Project Manager. See above, for navigation

See Section 1-1 above, for navigation.

- Click anywhere in the **Contractor** area to highlight it. You will see a shadow line on the right side and

bottom of the active area.

- Click the **New** icon. A dropdown menu will appear.
- Select a contractor by pressing the down arrow and highlighting the contractor. Do not enter information in the columns on the right. SiteManager will update these fields as you input information.
- Click anywhere on the **Equipment ID - Description** area to highlight it.
- Click the **New** icon. A dropdown menu will appear. Select a piece of equipment by pressing the down arrow and highlighting the description.
- Enter information in the **Nbr of Pieces** field.
- Enter information in the **Nbr Used** field.
- Enter information in the **Hours Used** field.
- The **Hours Used** field is used for cost plus operations or specialized equipment.
- Click the **New** icon to add more equipment.
- Click **Save**.

Note: Each particular equipment type (i.e. backhoe) can only be entered once per DWR. Therefore, if you have more than one particular equipment type and this equipment is used for cost plus operations, you would need to enter a remark to record the separate work hours.



Comments relative to Contractor equipment can be added in the same manner as explained in the personnel type section above. However, if this piece of equipment will be used repeatedly on the project, if there is a potential for claim or it is significant enough to warrant record of use such as for specialty operations like a crane, then the equipment should be added to the Contractor’s master list of equipment including make, model, year and size. Contact your District SiteManager administrator if you wish to add detailed equipment information to a master list for a contractor.

The Remarks balloon shown on the tool bar above can be used to add specific details regarding the equipment such as whether it is rented / borrowed. Another advantage to the use of the Remarks Balloon is to comment on the quality, type of use or status of the equipment (idle or not) or any additional optional equipment to support or enhance its performance. However, if this piece of equipment will be used repeatedly on the project, if there is a potential for claim or it is significant enough to warrant record of use such as for specialty operations like a crane, then the equipment must be added to the Contractor’s master list of equipment including make, model, year and size. Contact your District SiteManager representative if you wish to add detailed equipment information to the master list for a contractor.

Daily Staff

Navigation to enter inspection force personnel is:

- Click the **New** icon. A dropdown screen will appear.
- Choose your name and enter your regular and overtime hours.
- Click the **Remarks** icon and enter your start and end times. (ie 0700-1530).
- Click the **Remarks** icon again to close the window.

After all information has been added relating to the **Daily Staff** tab, click **Save**

Work Items

This is where you will enter all information specific to the items of work which you cover. Most of the information will be entered into the **Remarks** field attached to the item screen.

For consistency, the following procedures for entering information have been developed. It is important that this procedure be followed in order to assure that the reports utilized by inspectors and others are accurate.

When the **Work Items** tab is active, the project item list is visible.

- Scroll through the list to find the pay item you wish to report on.
- Double click the item to navigate to the item screen.
- Click the **New** icon
- Click the **Contractor** pull down menu to select a contractor. Be sure to choose the appropriate contractor for the assigned item.
- **Do NOT pay the prime contractor for work completed by a sub-contractor.**
- **If the work by a subcontractor is inadvertently paid to the prime contractor, it should be corrected immediately on another DWR.**
- **If an unapproved sub is performing work, select the Prime Contractor and enter a zero (0) payment in the placed qty. field. When the subcontractor is approved, then pay them for the work on a DWR.**
- Enter the location of work in the **Location** field. This should be related to the appropriate baseline to correlate to the station information to be entered later:
- For projects with one baseline- you could enter "Route 6."
- For projects with multiple locations or baselines, list the identifier that applies to the station information- i.e. Site#5, Route 6 or Rhodes Rd.
- For single site bridge projects where the station information might not be applicable near the bridge structure, you could enter WW1B or abutment 1 etc.
- Enter the beginning and ending station, as well as the direction and approximate offset distance from the baseline for each in the appropriate fields, at the bottom of the item screen.
- In the **Offset** box enter **rt.** for right of baseline or **lt.** for left of baseline. The appropriate orientation is as if you were standing looking up-station (from station 1 to station 2).
- If you are on a single bridge project and stations do not apply to the location, then do not enter information in the station fields.

TIPS

- ❖ If a contractor was not selected in the Contractors tab, the pay fields will not be active (white). To make payments on a DWR that does not track contractor activity (monthly items), you must select a contractor under the Contractor tab, but it is not necessary to select any personnel or equipment.
- ❖ Be advised that if you choose to enter information in one of the Station, Offset, or Distance fields, you will have to make a notation in every one of the Station and Offset fields.

- Click the **Remarks** icon.
- Enter the remarks required by the Construction Manual in the remarks field.
- **If there is an unapproved Subcontractor performing work, enter the following information in the first line of the remarks field: “unapproved Subcontractor performing work” then subcontractor’s name, then note any pay quantity. This will allow a tabulation of work performed by the sub at a later date.**
- Next enter any references to other project documentation such as the Volume 3, ticket book ETC.
- Next enter all comments specific to the item as required in the Construction Manual.
- Any field measurements should be entered here.
- When entering information for a **Trafficperson** item, be sure to include the trafficperson’s name, affiliation, badge number (if applicable), hours worked, and lunch/no lunch in the **Remarks** field.
- If the trafficperson type does not have an item number associated with it then the information may be entered in the DWR Info tab Trafficperson field as outlined previously.
- Close the **Remarks** window by clicking the icon again.

If there is a second payment for that same pay item, click the **New** icon . You will see a second line appear and the **Loc Seq Nbr** field will read “2”. Enter information as stated above.

- Click the **Select Work Item** icon to return to the list of pay items.
Repeat the steps until all payments are entered.
- Be sure to select either **Y** or **N** for the **Measured Indicator** since this is a mandatory field. This box indicates whether or not the item was field measured.



The image shows a small rectangular window titled "Measured Indicator". Inside the window, there are two radio buttons. The first radio button is selected and is next to the letter "Y". The second radio button is unselected and is next to the letter "N".

- Both **Plan Page Number** and **Templt Used** should be left blank.
- Click **Save** .

Force Accounts

The **Force Accounts** tab is not being used at this time.

Open an Existing DWR

- From the Main Panel, double click Daily Work Reports(+)
- Double click the **Daily Work Reports** icon.
- Click the **Open Folder** icon at the top, or click **File** and select **Open** from the dropdown menu.
- Double-click the contract number. The **Contract ID** window will open.
- Double click the **Inspector Name** for the DWR you are opening.
- Scroll through the list, and double click the date of the **DWR** you are opening

If you don't choose a contract first and then try to exit, a **Daily Work Reports** sub-window opens asking if you would like to “**Save changes?**” Click **No**. Be careful that you do not accidentally save the **DWR**. Saved **DWRs** cannot be deleted.

If you try to open one of your own DWRs that has been authorized by the Project Manager (Chief Inspector), a message will appear informing you that “**Daily Work Report will be opened as Read Only**”. This means that no information can be modified. Click **OK** to continue. But, if the Project Manager has not authorized your **DWR** yet, the **DWR** will open with the **DWR Info**. tab active.

If you try to view any **DWRs** that were created by another user, you will also get the “**Daily Work Report will be opened as Read Only**” message.

Copy an Existing DWR

On days where men and equipment do not change much, it is possible to copy an existing **DWR**. The data from the **Contractors**, **Contractor Equip.**, and **Daily Staff** tabs will be copied from an existing **DWR** to a new **DWR**.

- Open the original **DWR**.
 - Double click anywhere in the **DWR Date** field. The **Select Date** window will open.
 - Select the date of the new **DWR**.
 - Click **OK**. The **Copy?** window opens asking if you would like to “**Copy Contractor Information?**”
 - Click **Yes** or **No**.
- When **Yes** is clicked, a new **DWR** will appear with the new date. Information on the **Contractors**, **Contractors Equip.**, and **Daily Staff** tabs will be copied.
 - This information needs to be reviewed and modified as required.
 - If **No** is clicked, no information will be copied, and a new **DWR** will appear with the new date.
 - After all information has been added relating to the **DWR Info.** tab, click **Save** .

NOTE: This feature allows repetitive information to be carried from one DWR to the next, which will result in a savings of time and effort.

Review a DWR

Navigation to review a **DWR** is:

- Click **Services** and choose **Preview DWR** from the dropdown menu or click the **Preview DWR** icon. 
- The **Print Preview** window opens. Review the **DWR** to ensure the information is correct.

Mobile Inspector Application

Using the Mobile app, inspectors can enter **DWRs** on their mobile device. Refer to the quick guide, located in ProjectWise, by utilizing the link below.

[Mobile Inspector Quick Help Guide](#)

After installing the app on your mobile device, email your **Device ID** and **Contract Number(s)** to the OOC SM administrator (cc: your SM district representative).

- **Updating User profile** (SM Administrator)
- add Mobile Inspector role to user profile.
- add **Device ID** from tablet to Generic String 3 cell within user profile.

Updating Contract Authority

- Use **Contract Authority** to add Mobile Inspector role and the contract number(s).

Main Panel > Contract Administration > Contract Records > Contract Authority
Double-click name or userid

Click the **New** icon at top
Add contract and **Mobile Inspector** role
(Role has to be assigned to the person via the user profile)

Section Three – Daily Diaries**Diary**

The Diary is entered by the Project Manager (Chief Inspector) to track time (days), and to authorize (approve) **DWRs** entered by inspection forces. A diary needs to be entered for every calendar day from the actual **Start Date** to the **Completion Date**.

For work performed after the **Substantial Work Completed Date** (i.e.: punch list), a **Diary** is required when a **DWR** is entered.

For days of active construction or days with contractor payments (monthly pay items, etc.), **DWRs** must be entered.

The Project Manager provides a summary of the day's activities in the **Diary** if it is not already provided in their **DWRAs** in the above example, proper reference should be made.

TIP

- ❖ A **DWR** needs to be entered before you use the **Diary** to authorize the **DWR**. If the **DWR** is not in the system, it will not appear in the **Diary**, and the **Project Manager** cannot authorize it.

It is advisable to select your contract upon entering SiteManager:

- Double click the **Contract Administration (+)** icon.
- Double click the **Contract Records (+)** icon.
- Double click the **Contracts (or Projects)** icon. The **Select Contract** window will open.
- Double click your appropriate **Contract ID**.

All **Diaries** that you enter from this point will be related to your Contract.

Create a Diary

- Click the **Main Panel** icon.
- Click the **Main Panel** tab.
- Double click the **Daily Work Reports (+)** icon to open the **Daily Work Reports (+)** menu.
- Double click the **Diary** icon to open the Diary window.

The **Authorize** tab will be active, and the current date will be shown.

- Double click on the '**Diary Date:**' field. A calendar will open with the current date highlighted.
- Click the desired Diary date, and click **OK**. You may also put the cursor in the date field and manually input the six-digit date.

Enter Information on a Diary**TIP**

- ❖ If there are **DWRs** created for the selected date, they will be listed by the inspector's name in the **Inspector** field. Prior to authorizing the **DWR**, the Project Manager must review it.

The following examples are recommendations for entering information within the **Remarks:** fields:

There are four scenarios for entering information within the **General** category:

1. Project Manager, with no sub-inspectors, and no activity or payments:
General No Contractor Activity: Saturday.
South Street closed, detour in effect.
2. Project Manager, with no sub-inspectors, with contractor activity or payments:
General Vee Construction – East St. - drainage
CCA – East St. – construction staking
Santoro – East St. – saw cutting
Conn. Traffic Control – East St. – traffic control
Phone call to DOT Design, RE: plantings.
Issue speed memo to prime, RE: turf est. req'd for slope stabilization.
3. Project Manager, with sub-inspectors and no activity or payments:
General No Contractor Activity: Prime Contractor to Project 123-123
Butler, G.: Review Cost Plus
Pastorius, J.: Testing
Harris, S.: Volume III Computations
Phone call to DOT Design, RE: plantings.
Issue speed memo to prime, RE: turf est. required for slope stabilization.
4. Project Manager, with sub-inspectors, with contractor activity or payments:
General See DWR MMDDYY morrisk for end-of-month payments.
See DWR MMDDYY biafrac for saw cutting and utilities.
See DWR MMDDYY ogren for drainage, traffic control and staking.
Phone call to DOT Design, RE: plantings.
Issue speed memo to prime, RE: turf est. required for slope stabilization.

Categories can be left blank if there are no relevant comments. Information is only required if it pertains to significant events that occurred on the project. Other Categories contained in the **Diary** are:

Accident
Compliance Notice
EEO Issues
Environmental
Lane Closures
Meetings
Non-Compliance Notice
Personnel Remarks
PE Record Review
Possible Cost Plus
Possible Dispute or Claim
Railroad Force Account
Safety Violations
Trafficperson
Utility CON-40 Info
Visitor
Weather
Work Hours

TIP

❖ You can copy and paste from a **DWR** to the **Diary**.

Charge Days

Click the **Charge** tab to view the contract time related fields.

SiteManager tracks contract days based on the information entered in these fields.

When a diary is created, SiteManager will default the **Charge Type** to **Full Day**.

This needs to be changed once the project is substantially complete, or if the **Contract has a winter shutdown**.
 Navigation to change the **Charge Type** is:

- Click the field next to **No Charge**

The **Credit Reason** field will become active.

- Select the appropriate reason from the dropdown menu.
- Click **Save**
- Click the **Authorize** tab

Review and Authorize a DWR (in the Diary)

With the **Authorize** tab active, the Project Manager can review **DWRs**.

Navigation to review a **DWR** is:

- Click the desired **inspector** name
- Click the **Services** dropdown menu
- Select **Preview DWR**. The **Print Preview** window will open.
 - Review the **DWR** to ensure information has been entered correctly. The only person who can change **DWR** information is the **DWR** creator.
 - Close the window to return to the **Diary**. If the **DWR** information is accurate, the Project Manager can authorize the **DWR**.
- Check the box under **Authorized** to approve the **DWR**.
- Click the **Save** icon. The authorized date will appear in the **Authorized Date** column.
- Repeat these steps for each **DWR** listed.
- If a mistake is found on a **DWR** at a later date (but before the next estimate), the **DWR** can be unauthorized and corrections can be made.



To unauthorized the **Diary** (before the estimate has been generated), click the **Authorized** box to remove the check mark. Click the **Save** icon. Then, make the necessary corrections on the **DWR** and click the **Save** icon. Go back to the **Diary** and re-authorize. Click **Save**.

Diary Adjustments

If the charges on a Diary need to be corrected later (after an estimate), a **Diary Adjustment** can be made.

Click **Main Panel** icon.

Click **Main Panel** tab.

Double-click **Daily Work Reports** icon.

Double-click **Diary Adjustments** icon

Double click your appropriate **Contract ID**.

Double-click **Diary** Date

Click **New** icon.

Charge: Choose **Full Day** or **No Charge** from the dropdown menu

Credit Reason: Choose reason from the dropdown menu

Remarks: add any Remarks

Click **Save**

Section Four – Contract Estimates

Installed Work Report

Before generating an estimate, you can view the work installed on approved DWRs since the last estimate.

From the **Main Panel**, click the **Contractor Payments (+)** icon.

Click the **Reports (CP+)** icon.

Double-click the **Installed Work** icon.

Choose your contract from the Report Criteria and click **OK**.

Generate an Estimate

- Click the **Main Panel** icon.
- Click the **Main Panel** tab.
- Double click the **Contractor Payments (+)** icon.
- Double click the **Estimate (+)** icon.
- Double click the **Generate Estimate** icon.
- The **Contracts** window will open.
- Double click the contract.
- The **Generate Estimate** window will open.
- SiteManager will assign an estimate begin date. Enter the required **End:** date manually, or by choosing the date from the calendar.

SiteManager will default **Type** to **Progress**.

- Click the **Generate Estimate** icon. 
- A window opens stating, “Job Submitted to BACKGND”. Click **OK**.
- A window opens stating, “Process OCPINTESA Submitted.”. Click **OK**.
- After a short wait, a window opens stating, “Profile OCPINTES for process OCPINTESA has completed”.
- Click **OK**.

All fields within the **Generate Estimate** window will become grayed out.

- Close the window by clicking the **X** in the upper-right hand corner.

PDF Print an Estimate

- On the **Main Panel**, double click the **Contractor Payments(+)** icon
or Click on the **Contractor Payments (+)** tab.
- Double click on the **Process List** icon.
- Double click FEDAID-4 Payment Estimate\Federal Aid Sheet (print Is).
- Click **Subset**.
- Double click the contract number and the estimate number you want to PDF print. Click **OK**.
- Click **Submit**.
- Click **OK** when message appears that “**Process FEDAID-4A submitted.**”
- Click **OK** when message appears that “**Profile FEDAID-4A for process FEDAID-4 has completed.**”
Note: If you do not get the “completed” message after 30 Seconds, continue to the next step
- Click **Services** and choose **Process Status** from the dropdown menu.
- Double click on **FEDAID-4A**.
- Double click on **Output.html**. Your estimate will appear.
- Click the drop-down menu on the right side of printer icon. Click **Page Setup...** and select Landscape. Click **OK**. You can now PDF print the estimate by clicking the **Printer** icon.
- The PDF will now be located Computer\O: or S:\SiteManager\sm_public folder.

Note: If you request the estimate to be printed again, it will now be FEDAIDB, and then C, etc.

Approve an Estimate

The **Contracts** window will be open.

- Click the **SiteManager Panel** icon (the **Estimate (+)** tab will be active).
- Double-click the **Estimate Approval** icon. The **Select Contract/Estimate** window will open.
- Double-click the contract. The **Estimate Approve** window will open. Check to ensure that the appropriate estimate number is correct.
- Within the **Approval Levels** field, check the box next to your name. – If a window opens that mentions discrepancies, click **No**. (The information from Discrepancies should be reviewed and used to update material testing and construction orders)
- Click **Save**.
- After a short wait a window opens stating, “Mail Sent to PE.” Click **OK**.

The **final** estimate of a contract must have a status of **APRV** in SiteManager. If the last estimate has a status of **MINM**, the Contract cannot be changed from **Active** to **Complete** status in SiteManager. The SM administrator will need to request a database change from OIS.

Contract Adjustments

Contract adjustments are made when a payment that applies to the entire contract needs to be withheld or released. They may be used to enter Liquidated Damages related to Lane Restrictions (M&P), to release retainage or for other items, such as incentives/disincentives related to pavement placement.

To enter a Contract Adjustment:

- 1) From the Main Panel, Navigate to Contract Payments
- 2) Open **Contract Adjustments**
- 3) Select Contract. The contract must have a pending estimate in order to enter an adjustment.
- 4) Select either File -> New or choose the **New** icon from the tool bar.
- 5) From the dropdown menu select the adjustment type.
- 6) Enter the amount
- 7) Enter the adjustment reason in the remarks field. All manually entered adjustments **MUST** have a detailed remark entered.
- 8) Click **Save**, then either **Close** if you are finished or **New** if you wish to make another adjustment.

Contract Adjustment for Pavement

See the HMA Core Report (MAT-439) and/or the Daily Plant Adjustment Form for Adjustment Amount.

Note: Contract Adjustments may only be made to contracts with an estimate in pending or reject status.

- To add a new **Contract Adjustment** for Pavement
 - On the **Main Panel**, double-click the **Contractor Payment** icon.
 - On the **Contract Payments** panel, double-click the **Contract Adjustments** icon.
 - In the list box, scroll to and click the desired contract.
 - Click **OK**
 - Click the **New** button or click **File > New**.
 - In the Adjustment Description drop-down list, click the expand arrow to the right of the current selection and click the desired choice. (**Bituminous Concrete Density Lot Adjustment or Bituminous Concrete Production Lot Adjustment**)
 - In the Adjustment Amount field, enter the adjustment dollar amount.
 - In the remarks field, enter detailed remarks (but less than 256 characters) including date of placement and contract item).

Line Item Adjustments

Line item adjustments are used to (temporarily) adjust individual payments or quantities for specific items. They may be used to withhold payment due to lack of testing, deficient or substandard work, or for other items.

To enter a line item adjustment:

- 1) From the Main Panel, Navigate to **Contract Payments**
- 2) Open **Contract Adjustments**
- 3) Open Line Item Adjustments. The Select Contract window will open.
- 4) Select **Contract**. The contract must have a pending estimate in order to enter an adjustment.
- 5) Select either **File -> New** or choose the **New** icon from the tool bar.
- 6) From the drop down menu choose the project number.
- 7) Enter the Line Item number you wish to adjust in the appropriate box.

- 8) From the drop down menu, choose the type of adjustment you wish to make. Although there are several choices, there are only three that should be used at this time. These should be limited to:
 - Insufficient Testing
 - Overrun
 - Bituminous
- 9) If you enter an amount in the amount field, be sure that both Quantity and Unit Price read as 0. **The Contract Line Item Adjustment Amount is entered only when unit price and quantity are both blank. A cross edit verifies that either Unit Price or Quantity are entered or that the Adjustment Amount is entered, but not both sets of fields. The default Line Item Adjustment Date is the current date. The user can only change the date to a past date.**
- 10) Enter a comment in the remarks bubble as to why the adjustment was made.
- 11) Click **Save**, then click **Close** (if you are finished) or **New** (if you wish to make another adjustment).

Liquidated Damages

Liquidated Damages, as they pertain to this section, apply only to **Liquidated Damages** based on time. The daily rate of Liquidated Damages is entered on the Contract Header at activation and is found in the Contract. For other types of Liquidated Damages, such as those taken for Maintenance and Protection of Traffic violations, refer to the Contract Adjustment section.

To enter liquidated damages:

- 1) From the Main Panel, Navigate to **Contract Payments**
- 2) Double-click the **Contract Adjustments icon**
- 3) Double-click the **Liquidated Damages icon**. The Select Contract window will open.
- 4) Select **Contract**. The contract must have a pending estimate in order to enter an adjustment.
- 5) Select either **File** -> **New** or choose the **New** icon from the tool bar.
- 6) Enter the number of days to be applied.
- 7) Enter the adjustment reason in the remarks field. All manually entered adjustments **MUST** have a detailed remark entered.
- 8) Click **Save**, then click **Close** (if you are finished) or **New** (if you wish to make another adjustment).

Concrete Adjustments require similar steps.

NOTE: Do **not** create CO items instead of making adjustments(i.e. LD0001 and HMA001)

Creating a New Stockpile

- On the **Main Panel**, double-click the **Contract Administration icon**
- Double-click the **Contract Records icon**
- Double-click the **Stockpiled Materials icon**
- Using the toolbar at the top, click **Services**, and then click **Choose Keys**
- Using the toolbar at the top, click **File**, and then choose **Open** from the dropdown menu
- Double-click the **Contract ID**, and then double-click the **Project Number**
- Double-click contract item for stockpile

Contract ID: 0082-0299	Project Nbr: 0082-0299	Catg Nbr: 01	Line Itm Nbr: 0019
Units: Pound	Unit Price: 3	Bid Quantity: 3200	
Item Description: DEFORMED STEEL BARS-EPOXY COATED			
Supp Description 1:			
Supp Description 2:			

Matl Code:	Stockpiled Desc:	Status: Open			
Invoice Date: 11/15/11	Invoice Number:	Quantity: .000	Units:	Unit Price: \$.00000	
Conv Factor: 0.00000	Conv Unit Price: \$0.00000	Invoice Amt: \$0.00000	Initial Invoice Payment: \$.00	Matl Sn: 2	Replenish Sn: 0
Remaining Qty: 0	Installed Qty To Date: .000	Paid To Date: \$.00			

Fill in the necessary information for the following fields from the schedule of prices/contractor invoice:

Matl Code - leave blank

Stockpiled Desc. – enter description of stockpiled material

Invoice Date – Change to date on contractor invoice

Invoice Number – Enter IS (stockpile located in-state) or OS (stockpile located out of state) for the location of the stockpile, then the number on the contractor invoice

Quantity – enter quantity of material

Units – enter unit of actual contract item (use drop down List)

Unit Price – enter stockpile unit price (material value/ item quantity)

Conv. Factor – enter 1.0

Invoice Amt –same as “Initial Invoice Payment” (will automatically compute)

Initial Invoice Payment – enter what contractor wants to be paid or amount determined by the District after evaluation of the remaining costs of the item (whichever is less)

Click **Save**

NOTE: Never delete/update a stockpile when an estimate is pending.

From **SiteManager Reporting**, use “**Stockpile Material info**” and “**Active Stockpiles Sorted by Project and Item Code**” for current contract information about **Stockpiled Materials**.

As long as final contract quantities are equal to or greater than the original quantity, all stockpile items should automatically zero out.

If not (or if you’re not sure)...

To zero out the stockpile(s) manually.

Double-click the **Main Panel** icon

Double-click the **Contract Records** icon

Stockpiled Materials

File > Open and choose **Contract ID**

Click **Stockpile** and Click **OK**

Click **Services** and **Close Out Balance** from the drop down menu.

Section Five – Sampling and Testing

Materials Testing (MAT-100s)

It is advisable to select your contract upon entering SiteManager:

- Double click the **Contract Administration (+)** icon.
- Double click the **Contract Records (+)** icon.
- Double click the **Contracts (or Projects)** icon. The **Select Contract** window will open.
- Double click your appropriate **Contract ID**.

All **Mat-100's** that you enter from this point will be related to your Contract.

Contract-Item-Materials Report

Prior to the testing of any materials on a contract, the inspectors **MUST** have the correct item codes (and unit types) to assign proper testing to specific materials. The item codes (and unit types) are available to the inspector on the CONTRACT-ITEM-MATERIALS report. In addition to supplying the item codes (and unit types), this report also supplies each and every material that needs to be tested for each contract item. The following navigation will allow the inspector to obtain this report:

- Click the **Main Panel** icon.
- Click the **Main Panel** tab.
- Double click the **Materials Management (+)** icon.
- Double click the **Process List** icon. The **Process List** window will open.
- Double click the “CITM_GEN” under the **Process ID** heading (or “Revised Item Material Assignments by Item Code” under the **Process Description** heading). The **Confirm Process Submission** window will open.
- Click on the **Subset** button. The **Select Subset** window will open.
- Click the contract.
- Press the **OK** button. The **Confirm Process Submission** window will re-open.
- Click on the **Submit** button.
- A window opens stating, “Process CITM_GENB Submitted.”. Click **OK**.
- A window opens stating, “Profile CITM_GENB for process CITM_GEN has completed.”. Click **OK**.
- Click **Services** on the upper **Toolbar**.
- Choose **Process Status**. The **Process Status** window will open (the **Regular** tab will be active).
- Double click the “CITM_GENB” choice under the **Process Name** heading. The **Files for Process CITM_GENB** window will open.
Double click the “Output.html” choice under the **Name** heading. The **CONTRACT-ITEM-MATERIALS** window will open.
- Click drop-down menu on right side of printer icon. Click **Page Setup...** and select Landscape. Click **OK**. You can now PDF print the estimate by clicking the Printer icon.
- The PDF of the report will now be in your Computer\O:\sm_public\SiteManager folder..

Place this report within your testing file. You will need to refer to this report when you enter a new MAT-100 into SiteManager.

The “Contract Item Material Assignments Original” report is similar and also very useful, This report will populate even if a contract has not been activated yet (i.e. still pending).

Create a MAT-100

- From the Main Panel, double click the **Materials Management (+)** icon.
- Double click the **Sampling and Testing (+)** icon.
- Double click the **Sample Information** icon.

The **Maintain Sample Information** window will open (the **Basic Sample Data** tab will be active).

Basic Sample Data

Enter information in the listed fields as follows:

- **Smpl ID:** All general MAT-100's will be a minimum of fifteen (15) characters long. Enter according to the following format:

The capital letter "C" ("T" for municipal projects), the 4-digit town number, a hyphen, the 4-digit **contract number**, the capital letter "C", the 4-digit sample number (example: C0051-0251C0001).

TIPS

- ❖ If a MAT-100 is for bituminous material, the second capital "C" will be substituted with a capital "B" (example: C0051-0251B0001, with the 4-digit sample number resetting to 0001).
- ❖ Use Sample Type Dropdown List.
- ❖ If a MAT-100 is to be used for a Concrete Cylinder Test, use C6001. (Example: C0051-0251C6001). For the next Concrete Cylinder Test, use C6002, etc.
- ❖ If a MAT-100 is being used as an 'A' version to an existing MAT-100, a capital "A" will follow the 4-digit sample number (example: C0051-0251C0001A).

- **Status:** This field is left as the default "Spaces". When you have completed the MAT-100, change the status to Pending. (Note: The LAB will not be able to retrieve the MAT-100 unless the sample status is Pending.)
- **Revised By:** This will automatically be filled in on an original MAT-100 that was revised. Otherwise, it will be a grayed area.
- **Revising:** This is automatically filled in on the MAT-100 if you selected "Revise" from Services. Otherwise, it will be a grayed area.
- **Smpl Dt:** Manually input the six-digit date.
- **Link To:** Leave this field blank.
- **Link From:** As with other aspects of SiteManager, grayed areas are non-enterable.
- **Log Date:** Leave this field blank. (Note: The LAB will enter the Log Date as the date that the sample is received by the LAB)

- **Smpl Type:** Select the appropriate sample type from the dropdown list. (Note: Bid Sample is not for Construction use)
- **Acpt Meth:** Select the appropriate acceptance method from the dropdown list. (Note: Past Performance is for LAB use only)
- **Material:** Place the cursor over the white field and right-click the mouse to perform a “search”. The **Search Window** will open. Scroll down and single-click the correct Material Code you are testing. Press **OK**. The material name will be entered in the field adjacent to the **Material** field. (Note: If the Material Code is not available, contact the Representative at the DMT.)

TIP

The **Material Code** that you are searching for in this field is the code that was supplied to you in the **CONTRACT-ITEM-MATERIALS** report as mentioned in the beginning of this section.

- **Sampler:** Place the cursor over the white field and right-click the mouse to perform a “search”. The Search Window will open. Scroll down and single-click your name. Click **OK**. Your full name will be entered in the field adjacent to the **Smpld By** field.
- **P/S:** Place the cursor over the white field and right-click the mouse to perform a “search”. The **Search Window** will open. Scroll down and single-click the correct **Producer Supplier Code** (or **Producer Supplier Name**). Press **OK**. The producer or supplier of the material will be entered in the field adjacent to the **P/S:** field.
- **Type:** As with other aspects of SiteManager, grayed areas are non-enterable. If information is available, SiteManager will automatically populate this information directly into this field.
- **City:** As with other aspects of SiteManager, grayed areas are non-enterable. If information is available, SiteManager will automatically populate this information directly into this field.
- **Prod Nm:** Leave this field blank
- **Mnfctr:** Leave this field blank.
- **Town:** Enter the town or city that the material is being utilized within.
- **Geog Area:** Choose the correct District from the dropdown screen that the material is being utilized within.
- **Intd Use:** Input a brief description of the intended use for the material. (Note: The intended use should not be “jobsite”, “project limits”, “throughout project”, etc.)
- **Repr Qty:** Enter the material quantity of the material that is being tested. (Note: This quantity cannot exceed the maximum quantity indicated in the “Frequency for Acceptance” column of the “Minimum Requirements for Sampling Materials for Test” for that particular material. Testing coverage for that material with the sample will only be recorded up to the maximum quantity allowed. Testing deficiencies will result if inspectors do not submit enough samples for the quantity of material used on the project. Just to the right of the quantity, use the drop down menu to choose the units.
- **Lab Control Number:** Leave this field blank.

- **Auth By:** As with other aspects of SiteManager, grayed areas are non-enterable. This information will automatically be populated when the MAT-100 is authorized.
- **Auth Date:** As with other aspects of SiteManager, grayed areas are non-enterable. This information will automatically be populated when the authorized date is entered by the LAB.
- **Lab Reference Number:** Leave this field blank.
- After all of the above listed fields have been addressed, press the **Save** icon.

Use COPY SAMPLE Only if the Material Code is to remain the same:

Note: If there are additional samples to be entered that contain the **same** material number, it is possible to copy the sample information, in a similar fashion as the DWR. Simply choose Services from the menu and then Copy Sample. You will need to enter a new sample ID and make any other necessary changes to this tab but most of the information from the previous sample will have been carried over to the new MAT-100.

Only for Catch Basins & Manholes:

In an effort to aid in streamlining the amount of time it takes to create MAT-100's for certain types of material, the Central Lab has issued a memorandum stating that MAT-100's pertaining to Pre-Cast Catch Basins and Manholes, which are to be completed structures only (1440A Catch Basin – Precast (complete) and 1441A Manhole – Precast (complete)) may be entered on a single MAT-100. It must be emphasized that project staff are required to attach all PC-1's that represent components used in the complete catch basin(s) or manhole(s) to the MAT-100. Should unrelated components also be listed on the PC-1, photocopies of the PC-1 may be made and attached to the other MAT-100's provided that the original was previously submitted to the DMT or are submitted at the same time. Photocopies of PC-1's will NOT be accepted unless the sample ID under which the original was (is) submitted is clearly noted and available for verification by DMT personnel.

Additional Sample Data

- **Smpld From:** If applicable, input a description of where the sample is from, such as truck, stockpile, bin, etc.
- **Plant ID:** The Plant ID should be entered if the material comes from a bituminous or concrete plant. Place the cursor over the white field and right-click the mouse to perform a "search". Only the Plant ID's associated with the Producer/Supplier listed on the Basic Sample Data tab will appear. Single-click the correct Plant ID. The plant name will appear in the field adjacent to the Plant ID field. The **Plant Type** will also appear after the Plant ID is selected.
- **Seal Number:** If applicable, input the seal number or batch number listed on the material certificate for materials such as glass spheres or epoxy paint.

Contract

- Click the **Contract** tab (At this time, all fields should be grayed out and empty.)
- Click the **New** icon. The **Select Contract/Material Information** window will open.

- Double-click the appropriate **Contract ID**. A new window will open listing all items that relate to the Material Code that was input previously.
- Click the correct item for the material to be tested.
- Click **OK**. The **AASHTO SiteManager** window will open asking the question “Do you want to add all Project/Line Items for Contract XXXX-XXXX to this Sample?”
 - Click the **Yes** button if you want them all the listed to be tested on this MAT-100. (Do not click **Yes** if there are more than 40 items.)
 - Click the **No** button if you want to pick and choose which items are to be added to this MAT-100. If you click the **No** button and additional items are to be added to this MAT-100, you must repeat the above steps starting with **Section 1-A105C-3-Active Tab = Contract:**. This must be repeated until all items are entered.

After choosing the required items for this MAT-100, all fields except **Represented Qty** within the **Contract** tab will be filled-in.

- The **Represented Qty** should be the material quantity for each line item. The total of all of the Represented Qty’s on this Tab should equal the **Represented Qty** on the **Basic Sample Data** tab. Note: This is no longer “Item Quantity”.
- Click **Save**.

If you want to submit additional information with this MAT-100, click on the **Remarks** icon. The **Remarks (General Remarks)**: window will open.

- Enter any additional information within this window. Some examples are: “PC-1 attached, cast dates are:”, “Material Certificate is attached”, “Sample accompanies MAT-100, Request Proctor, etc.
- Click the **Remarks** icon again.
- Click **Save**.

Tests

Use the **Tests** tab when the material is concrete.

- Click the **New** icon.
- Place the cursor over the white field in **Test Method** and right-click the mouse to perform a “search”.
- Single-click on **T22, Compressive Strength of Cylindrical Concrete Specimens**. Press **OK**.
- Enter the number **1** for **Sample Test Number**.
- Click the **Save** icon. The information for Sample Test Number 1 will now appear.
- Click **Services** and then **Enter/View Test Data** to enter the field test data.
- Enter the **Slump, Air Content Measure** and the **Concrete Temperature** measurements in the appropriate fields. Use the dropdown list for the **Units** for the **Slump** and **Concrete Temperature** measurements.

If you did not perform one of these tests, leave the field blank and enter the reason under **Remarks**.

- Click **Save**.
- Click the **Specimens** tab.
- Enter **1** for the **Specimen ID** and then the **Age of Cylinder**.

- Click the **New** icon to enter the next **Specimen ID** and **Age of Cylinder**.
- Repeat for Specimen ID 3 and 4.

Note: 4 Specimens or cylinders need to be submitted to the LAB for each set. The **Specimen ID** should be 1, 2, 3 and 4. The **Age of Cylinder** will usually be 7, 14, 28 and 28 (test according to contract specifications).

Also, only enter information for the **Specimen ID** and the **Age of Cylinder**.

- Click **Save**.
- Click **Close** to go back to the **Tests** tab.

Note: You will only have to submit one MAT-100 for each set of cylinders. (Ex. C0001-0100C6001, the next set of cylinders will be C6002, etc.)

The final step in creating a MAT-100 is changing the **Status:** field to **Pending** from **Spaces**. This is accomplished by clicking the dropdown screen within the **Status:** field and choosing **Pending**.

Click **Save**

PDF print a MAT-100

- From the Main Panel, double click the **Materials Management (+)** icon.
- Double click the **Process List** icon. The **Process List** window will open.
- Double click the **MAT100 Generates Mat100 for the Selected Sample**. The **Confirm Process Submission** window will open.
- Click the **Subset** button. The **Select Subset** window will open.
- Select the MAT-100 that you want to PDF print and then click **OK**.

NOTE: You can print several at once if you select the MAT-100's by holding the Control key and choosing several different ones. However, you MUST choose the highest number MAT-100 first, and then select the MAT-100's in descending order. (Example: Select C0051-0251C0005 before selecting C0051-0251C0004)

- Click **OK**. The **Confirm Process Submission** window will re-open.
- Click **Submit**.
- A window opens stating, **Process MAT100 Submitted**.
- Click **OK**.
- A window opens stating, **Profile MAT100 for process MAT100 has completed**.
- Click **OK**.

The **Process List** window will open. Click **Services** on the upper **Toolbar**, and choose **Process Status** from the dropdown menu. The **Process Status** window will open (the **Regular** tab will be active).

- Double click **MAT100** under the **Process Name** heading. The **Files for Process MAT100** window will open. Double click **Output.html** under the **Name** heading. The **Mat100 Hard Copy** window will open. Choose the **Print** icon to PDF print the report.
- Once you click **Print**, the PDF will be located here Computer\S: or O:\SiteManager\sm_public\PDF_Prints\your last name

NOTE: Occasionally, when you click PDF print, nothing shows up in your folder and there are no error messages.

Start minimizing windows in SiteManager. If you see this message box in the background, click **No**.

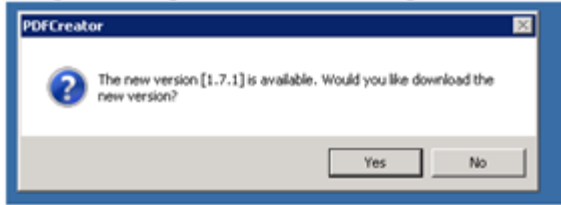

ALTERNATE WAY TO PDF PRINT A MAT-100

It is possible to PDF print a MAT-100 using **SiteManager Reporting** instead.

Click **Material Management Reports**

Click **MAT-100 Const., Purch. Stores and Maint.**

Click **Construction Reports**

Enter name of MAT-100

Click **Preview and PDF Print MAT-100**

Adding Filters in Site Manager

The following process can be followed in nearly every area of Site Manager where you can install a filter. Most common uses for filters are in the Materials Testing module, the Change Order Module, and any of the Process List reports.

The example shown uses the Sampling and Testing module but you can set up filters for any of the other modules by following the same steps.

- 1) To create your filter, first open your list:

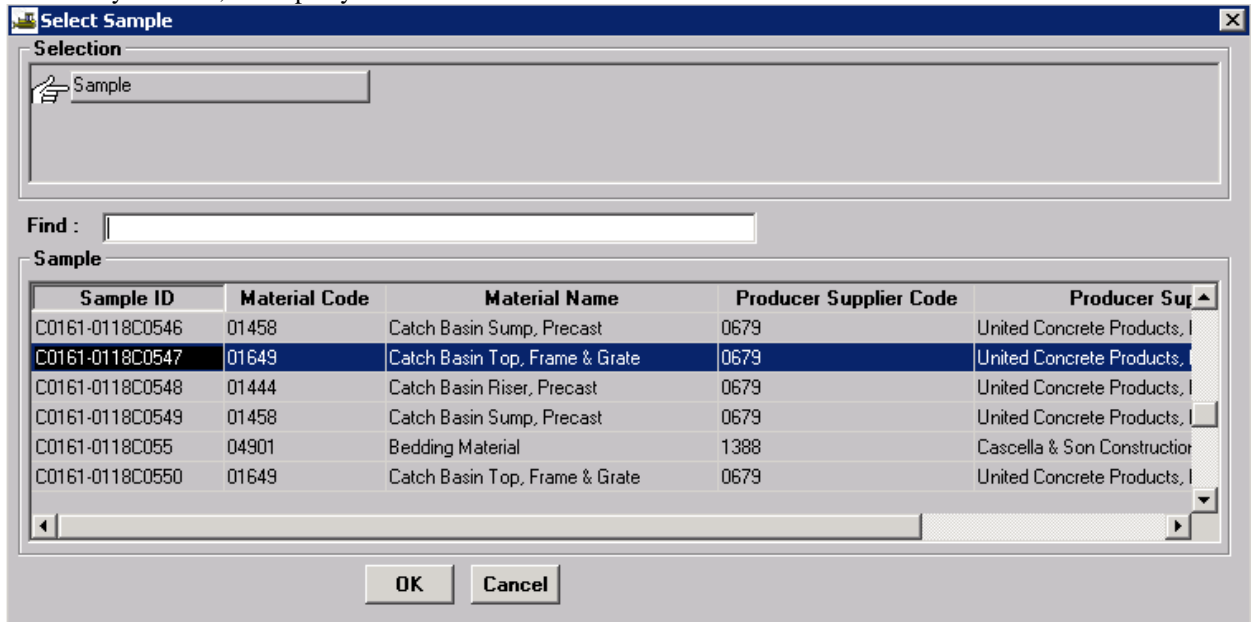

- 2) Right click on the Sample ID and select **filter**:

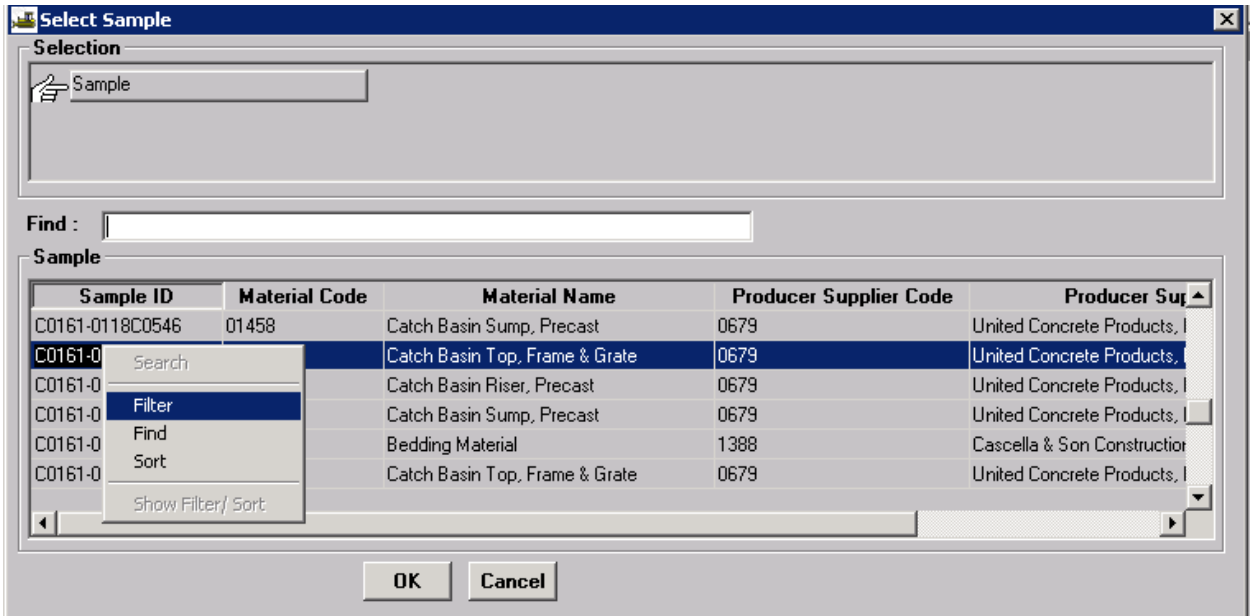

3) You should see this screen:

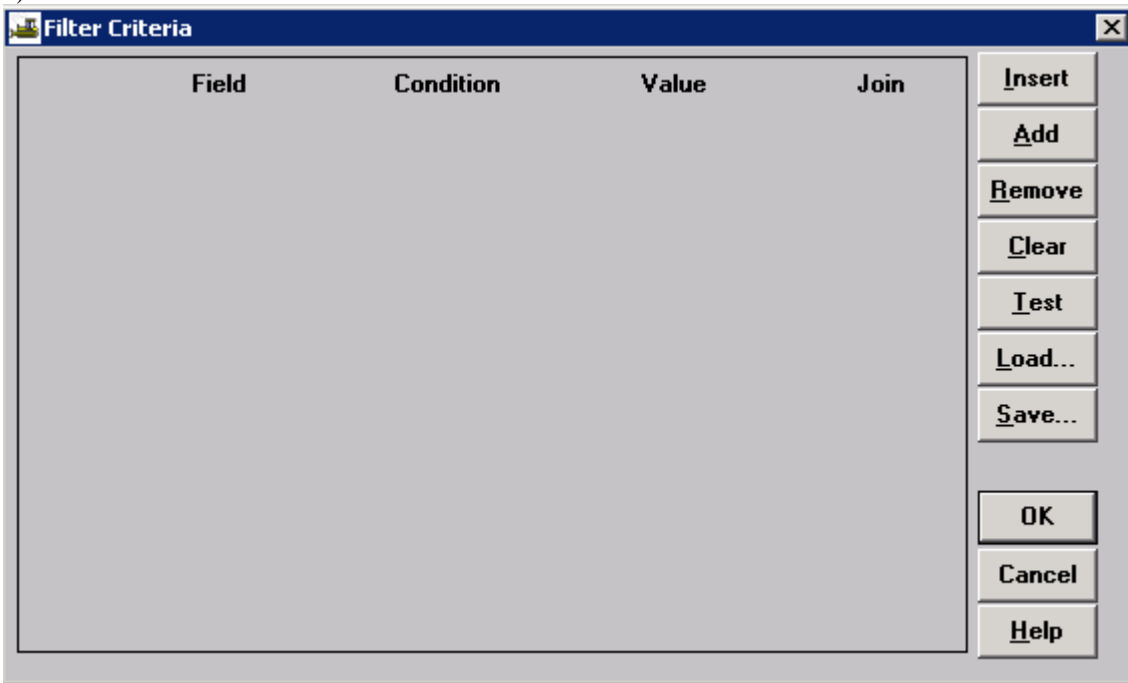

If the above screen is blank then you are ready to install your filter.
The most common way to filter results is by Sample ID.

3) Choose **Add** from the list on the right:

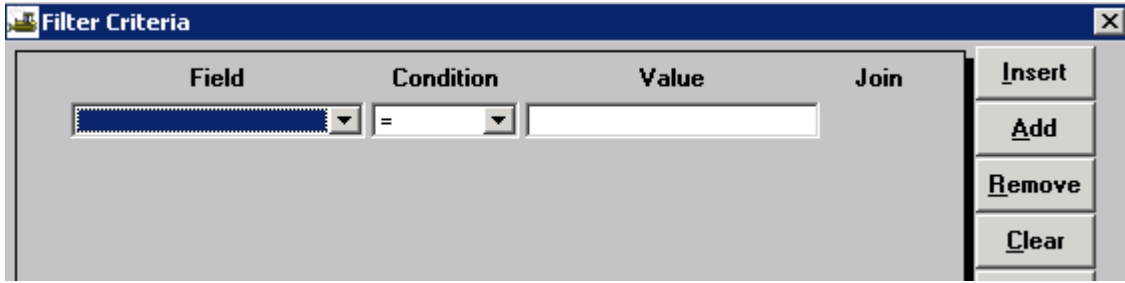

5) Choose **Sample ID** from the **Field** dropdown menu.

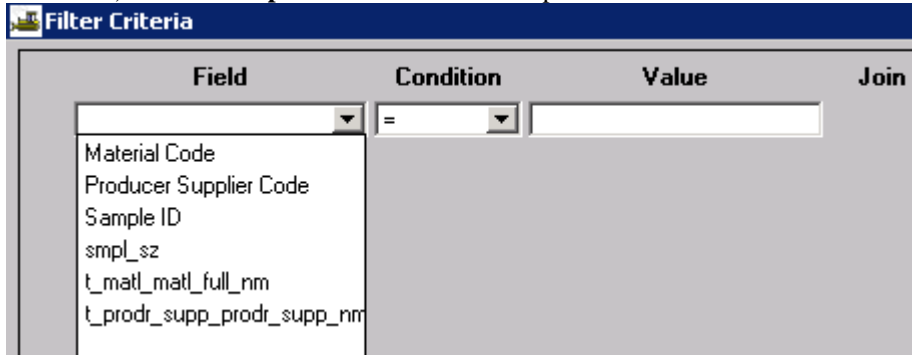

6) Choose **Like** from the **Condition** dropdown menu.

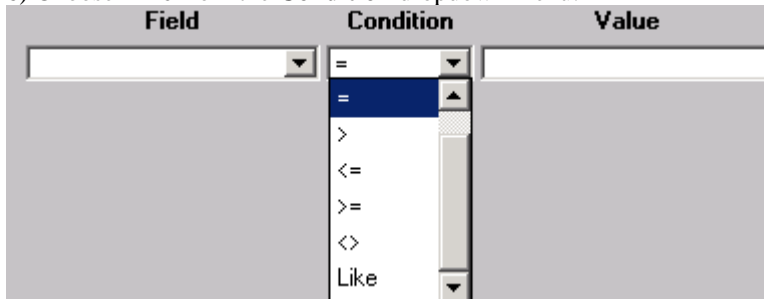

7) **Value:** Enter the beginning of your **Sample ID**

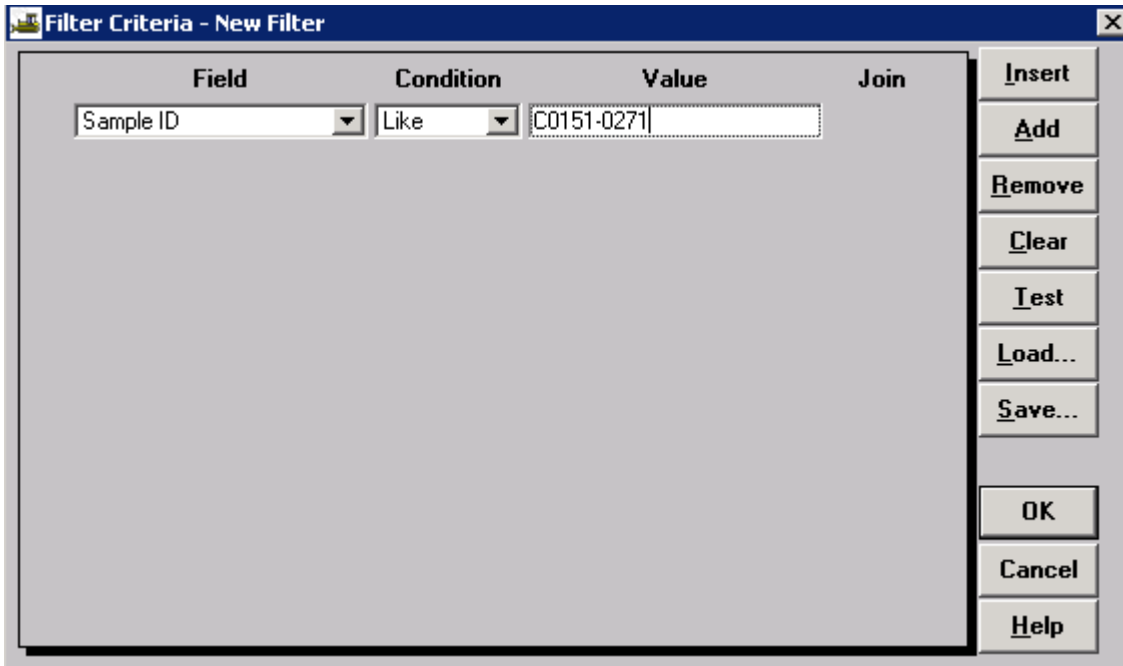

8) Click **Save**, and then name your filter. In most cases you will leave it as default (be sure to check the box), but if you have a few filters set up you can give it a unique name and click **OK**:

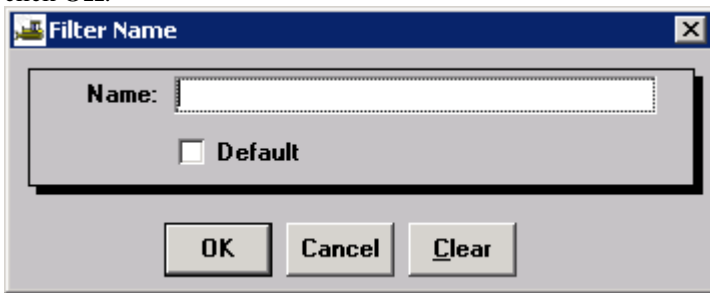

9) Click **OK** again and then you will see a message similar to this:

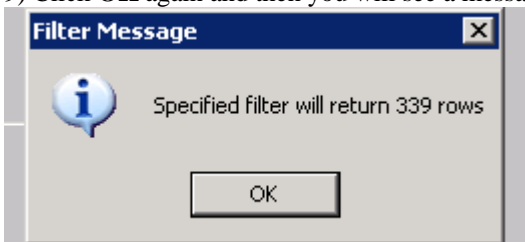

Choose **OK** and if a message appears stating you have exceeded the maximum number of rows, choose **OK** (or **Yes**) again.

You should now see just the records related to the project that you selected. If you gave the filter a name then you will have to open the filter dialog as you did in the beginning and choose the desired filter. If you set the filter as default then only your samples will be shown.

NOTE: If you are only seeing records from a different project, then you already have a default filter saved.

Removing Filters in Site Manager

1) Open the filter dialog box as shown in Steps 1, 2 and 3. You should see a screen similar

to the one shown in Step 7.

2) From the list on the right, choose **Load**

3) A window will open that looks like this:

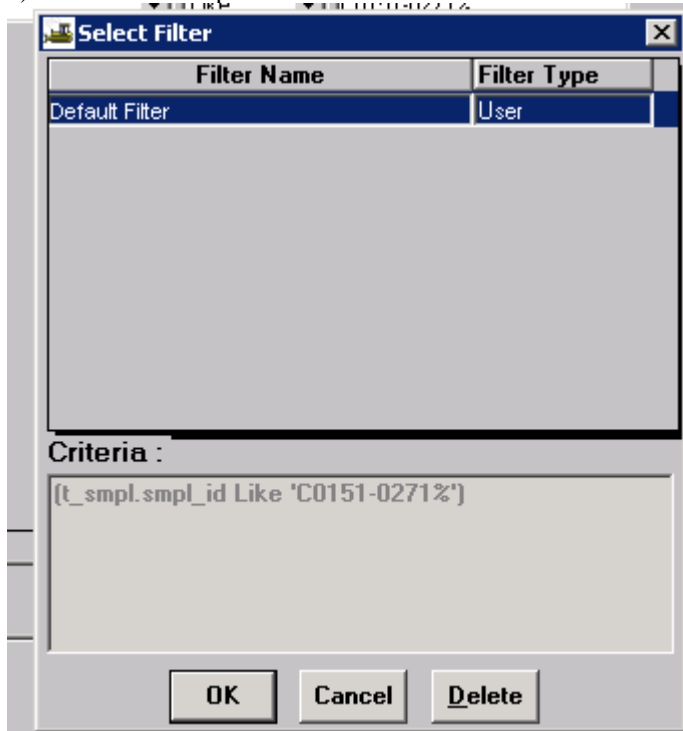

4) Click on the **Delete** button and click **YES** or **OK** to any messages that open.

5) Click **OK** and then click the **Remove** button from the list on the right. Click **OK** and all filters will be cleared. You can now set up a new filter .

Section Six – Construction Change Orders

Create a Change Order

It is advisable to select your contract upon entering SiteManager:

- Double click the **Contract Administration (+)** icon.
- Double click the **Contract Records (+)** icon.
- Double click the **Contracts** icon.
- Click File, and then choose **Open** from the pull-down menu. The **Select Contract** window will open.
- Double click your appropriate **Contract ID**.

All **Change Orders** that you enter from this point will be related to your contract.

- Click the **Main Panel** icon.
- Click the **Main Panel** tab.
- Click the **Change Orders (+)** icon.
- Double click the **Change Order Maintenance (+)** icon.
- Double click the **Change Orders** icon.

SiteManager will assign a **CO Number**.

- Enter information in the **Description:** field. For example: “Finalize item quantity.”, “Routine qty adjustment based on field measurements.”
- **Reason Code:** select an option from the pull down menu.

NOTE: Each Change Order should only contain one Reason Code.

- In the **CO Type:** select **Supplemental Change Order** from the pull down menu. ”.
- Click the box to add a check in the **Override Approval Rules** box.
- Click a box in the **Functions:** area based on the purpose of the Change Order.
- Click **Save** .

Status: field will be highlighted and in “**Draft**” mode.

Change Order Items

- Click **Items** tab.
- Click **Services**, then **Select Item**.
- Double-click item.
- Enter **CO Item Desc:**
- Enter quantity in the **This Change Order:** field under the Quantity column.
- Click **Save**.

Create a New Contract Item

NOTE: There are two Line Item Series utilized for creating a New Contract Item via a CO:

- 9000-Series Line Items correspond to Item Codes that begin with “CO”. These are used when adding a new item to the contract that was not included in the project item bid list.
- 6000-Series Line Items correspond to items in the Department’s Item Master List (Ex. 06010070, “Class S Concrete”). This series may **ONLY** be used to reallocate the same Item Code that was included at bid from one category to another. It is not intended to add items from the Item Master List that were not included in the original bid.

NOTE: SiteManager will not allow a new CO item to be created unless “**Extra Work**” is selected in the **Functions** area in the **Header** window. Refer to **Create a Change Order** above for navigation.

With the **Change Order Items** window open, and the **Change Order Item** tab active, click the **New** icon. In the **Line Item Nbr:** field, enter the new item number. The first new item of a contract will be numbered “9001”. The next new item is “9002”, then “9003”, etc.

- Use the drop down arrow to select a project in the **Project Nbr:** field.
- Use the drop down arrow to select a category number in the **Category Nbr:** field.
- Right click the **Item Code:** field, and click “**Search**”. A **Search Window** will open. The available item codes are in order of the specification year.

Scroll through until the correct **Spec Year** and correct **Unit** are viewable.

Be advised that the critical elements are the **Item Code**, **Spec Year**, and the **Unit**. The **Short Description** will be entered later.

Also, the **Project Manager** must record the **Item Code**. Typically, Project Managers will list all new contract items somewhere in their files. The **Item Code** needs to be on this list next to the new item number. The reason is that the Project Manager must ensure that **the same Item Code is not used for different items**.

For example: under the “2000” **Spec Year**, and the “c.p.” **Unit**, there are 30 available **Item Codes**. The first is “CO01100” and the next is “CO01099”. The Project Manager may select the first code for the first cost-plus item created on a contract. When another cost-plus item is needed, “CO01100” **will still be available**, but the Project Manager **must not** assign the same code for the second cost-plus item.

- Highlight the desired **Item Code**.
- Click **OK**. The **Change Order Items** window will reopen, with the **New Contract Item** tab active, SiteManager will have filled in several fields.
- Enter the **Unit Price**:
- Enter the **Proposal Line Nbr**: which is the same number as entered in the **Line Item Number**: field (9001, etc.).
- In the **Related Item**: field, used the dropdown menu for a selection.
- Enter the Item Description in **Supplemental Descriptions**:
- The **Critical**: and **Pay Plan Qty**: boxes remain unchecked.

The **Save** icon is inactive, so select the Change Order Item tab.

- Enter the **Change Order Item Description**: in UPPERCASE LETTERS. Only sixty (60) characters are allowed.
- Enter the item quantity in the **This Change Order**: field.
- Click **Save**.

To continue to create new items, click the **New** icon, and follow the same navigation.

- Close the window by clicking the **X** in the upper-right hand corner.

General Change Order Explanations

- Click on the **SiteManager Panel** icon (the **Change Order Maintenance (+)** tab will be active).
- Double click the **Change Order Explanations** icon.
- The **Change Order Explanations** window will open.
- The first pull down menu will default to **General Change Order Explanations**.



- Click the **New** icon. SiteManager will assign a **Seq. Nbr.** (sequence number), a **Type**, and the **Date Applied**. A new field will be added next to the words: **Pick Std Exp. ID or Enter Text Below**. Enter the name of the contract specifications in the large field. For example: “**Standard Specifications Form 81X and Supplemental Specifications dated July, 20XX.**”
- Click **Save**.

Specific Change Order Explanations

Every **Change Order** item, whether new or existing, needs to be associated, or classified, under two explanations. First, all items are to be associated with a **Standard Explanation**. They are: “Unforeseen Conditions”, “Change in Scope”, “Contract Revisions”, “Quantity Adjustments”, “Other Adjustments”, and “Time Extension”. Second, each item needs to be associated with an **Entered Text**. The text will explain why the adjustment is required, and list back-up correspondence.

Standard Explanations (Specific Items)

- **General Change Order Explanations.**
- From the dropdown menu, select **Explanations Applied to Specific Items.**

A new field will appear to the right of the existing ones. It will list all of the items that were entered in the **Change Order Items** window.

- Click the **New** icon. SiteManager will assign another **Seq. Nbr.** (sequence number), a **Type**, and the **Date Applied.**
- Right click the new field next to the words: **Pick Std Exp. ID or Enter Text Below.**
- Click **Search.** The **Search Window** opens.
- Highlight the desired **Explanation ID.**
- Click **OK.**

The **Search Window** will close, and the **Change Order Explanations** window will be open. The **Explanation ID** that was selected will be in the field, and the **Explanation Text** will be in the large field (which will now be gray).

- Double click (to the left of the **Project** column) all of the items that fall under that explanation.
- Click **Save .**

If another **Standard Explanation ID** is required, it needs to be added next:

- Click the **New** icon. SiteManager will assign another **Seq. Nbr.** (sequence number), a **Type**, and the **Date Applied.**
- Right click the new field next to the words: **Pick Std Exp. ID or Enter Text Below.**
- Click **Search.** The **Search Window** opens.
- Highlight the next desired **Explanation ID.**
- Click **OK.**

The **Search Window** will close, and the **Change Order Explanations** window will be open. The **Explanation ID** that was selected will be in the field, and the **Explanation Text** will be in the large field.

- Double click all of the items that fall under that explanation.
 - Click **Save**
- NOTE: Every CO item must have at least one explanation. Repeat this navigation until all items have explanations applied.**

Standard Explanations (All Line Items)

- Press the arrow for the pull down menu in the field that says “**General Change Order Explanations.**”
- Select **Explanations Applied to All Line Items.**
- Click the **New** icon. SiteManager will assign another **Seq. Nbr.** (sequence number), a **Type**, and the **Date Applied.**
- Right click the new field next to the words: **Pick Std Exp. ID or Enter Text Below.**
- Click **Search.** The **Search Window** opens.
- Highlight the desired **Explanation ID.**
- Click **OK.** The **Search Window** will close, and the **Change Order Explanations** window will be open. The **Explanation ID** that was selected will be in the field, and the **Explanation Text** will be in the large field (which will now be gray).
- Click **Save**

Specific Text Explanations (Specific Items and All Line Items)

Explanations associated with specific item adjustments are entered next. These explanations will be in the **Addendum** section on the change order printout. As an alternative to creating the addendum in this fashion, it is preferred that users create an attachment in Microsoft Word. Using MS Word allows greater flexibility when creating documents and includes the benefit of customized formatting. The instructions for creating an attachment follow the instructions on creating the addendum within SiteManager. It is highly recommended that users attach their addendum using an external word processing application rather than the internal explanations module. Future versions of Site Manager may include better formatting options, however at this time, the best option is to create an addendum outside of Site Manager.

To create an addendum using the Site Manager Module:

- Click the **New** icon.
- SiteManager will assign another **Seq. Nbr.** (sequence number), a **Type**, and the **Date Applied**.
- With a particular item (or items) in mind, enter information in the large white field explaining the required adjustment. Refer to the following example for the proper format:
**Line Item 0010 – Increase item quantity. Additional saw cutting is required to construct the roadway according to the staging plans.

**
**See attached correspondence:
**
**3a 05-14-04 Letter from Mr. Construction Co. Supervisor to Mr. Project Engineer
**
**3b 06-21-04 Meeting minutes

**

NOTES / TIPS

- ❖ Always begin with the words “Line Item”, and then list the line item number or numbers.
- ❖ The “
” stands for “break return”, which is required for a return between printed lines.
- ❖ The “

” gives two returns if an additional space is desired.
- ❖ FYI: “<bp>” stands for “break page”, and can be used if a page break is needed.
- ❖ The “
” will not be printed out on the actual Change Order Report (Portrait), but does print out on the Change Order Report (see Section 1-A106G below).

- ❖ When assigning a label to an attachment, the number corresponds to the Seq. Nbr. that was assigned by SiteManager.
- ❖ The oldest attachment is listed first.
- ❖ Attachment descriptions should be concise. Names are to be used if applicable.

- Double click all of the items that correspond to that explanation. If you select Standard Explanations applied to **All Line Items**, the list of the items will not appear.
- Click **Save**

To continue adding explanations that are to appear in the **Addendum**, repeat the navigation:

- Click the **New** icon. **SiteManager** will assign another **Seq. Nbr.** (sequence number), a **Type**, and the **Date Applied**. With another particular item (or items) in mind, enter information in the large white field explaining the required adjustment.
- Double click all of the items that correspond to that explanation (explanations for **All Line Items** will NOT have items listed).
- Click **Save**
- Close the window by clicking the **X** in the upper-right hand corner.

To create an addendum in an external application and attach it so SiteManager

- Navigate to the **Change Order Header**
- Choose the **Attachment** Icon and then the OLE icon, or select Service – Attachments – New – OLE from

the menu



- The **Insert Object** window will then appear. Scroll down the list of choices and select Microsoft Word Document, then click **OK**
- The OLE attachment window will open. Here is where the document name will be entered as well as other information.
 - In the **Name** field, choose an appropriate name, such as CO 001 Addendum
 - Enter a description in the text area if desired, although it is not necessary
 - In the section labeled **Attachment Security**, select the group levels that are allowed to open and review the attachment. If **Add All** is selected, then all users in **SiteManager** can view the document. At least one level must be selected.
 - Click the **Add** button.
- The OLE attachment will now be added and selectable in the window. To access the attachment, simply double click on it. This will open Microsoft Word and allow the Addendum to be created. When finished creating the addendum, click the **Save** icon or choose **Save** from the file menu. Do not change the file name as **SiteManager** has already assigned the name and uses that for its reference.
- The Addendum must be printed from MS Word. It will not be printed when the actual CO is printed from SiteManager.

The option to create an addendum locally, without creating the attachment in Site Manager is also available; however please remember to include that file with your Change Order when you submit it to your Project Engineer.

“No Item” Change Order

Some Change Orders do not require item quantity adjustments; for example: Time Extension, or Specification Change. These types of Change Orders have no items, so all descriptions and back-up information needs to be recorded in the **General Change Order Explanations** section of the Change Order.

It is advisable to select your contract upon entering SiteManager:

- Double click the **Contract Administration (+)** icon.
- Double click the **Contract Records (+)** icon.
- Double click the **Contracts (or Projects)** icon. The **Select Contract** window will open.
- Double click your appropriate **Contract ID**.

All **Change Orders** that you enter from this point will be related to your contract.

Header

- Click the **Main Panel** icon.
- Click the **Main Panel** tab.
- Click the **Change Orders (+)** icon.
- Double click the **Change Order Maintenance (+)** icon.
- Double click the **Change Orders** icon.

SiteManager will assign a **CO Number**.

- Enter information in the **Description:** field. For example: “Time Extension”, or “Change of method of

measurement for...”

- In the **Reason Code:** field, press the pull down and select and option.
- In the **CO Type:** field, press the pull down, and select “Supplemental Change Order”.
- Click the box to add a check in the **Override Approval Rules** box.
- In the **Functions:** area, click the applicable box(es).
- Click **Save**

The **Status:** field will be highlighted and in **Draft** mode.

Close the window by clicking the **X** in the upper-right hand corner.

Change Order Explanations

- Click the **SiteManager Panel** icon (the **Change Order Maintenance (+)** tab will be active).
- Double Click on the **Change Order Explanations** icon. The **Change Order Explanations** window will open. The first pull down menu will default to **General Change Order Explanations**.

Note: The three required explanations for a “No Item” Change Order will be included in the General Change Order Explanations category.

- Click the **New** icon.

SiteManager will assign a **Seq. Nbr.** (sequence number), a **Type**, and the **Date Applied**. A new field will be added next to the words: **Pick Std Exp. ID or Enter Text Below**.

- Right click the new field next to the words: **Pick Std Exp. ID or Enter Text Below**.
- Click **Search**. The **Search Window** opens.
- Highlight the desired **Explanation ID** (Time Extension, Quantity Adjustments, etc.).
- Click **OK**.
- Click **Save**
- Click the **New** icon.

SiteManager will assign the second **Seq. Nbr.**, a **Type**, and the **Date Applied**.

Describe the purpose of the Change Order. Refer to the following examples for the proper format:

In accordance with Article 1.08.08 of the Standard Specifications, the Contractor is granted a time extension of 62 days for various incidental extra work. The completion date is revised from July 29, 2015 to September 29, 2015.

Change Method of Measurement (from Tons to “calculated in place”) for the item “Processed Aggregate Base” in accordance with the Standard Specifications, Section 1.09.

- Click **Save**
- Click the **New** icon.

SiteManager will assign the third **Seq. Nbr.**, a **Type**, and the **Date Applied**.

Required back-up will be listed in this section along with a reiteration of the description from the second sequence. Refer to the following examples for the proper format:

**In accordance with Article 1.08.08 of the Standard Specifications, the Contractor is granted a time extension of 62 days for various incidental extra work. The completion date is revised from July 15, 2003 to September 15, 2003.

**

See attached correspondence:

1a January 14, 2004 Time Extension Report Change Method of Measurement (from delivered Metric Tonnes to calculated in place) for the item "Processed Aggregate Base" as approved by Office of Construction in a memorandum dated March, 22, 2004.

See attached correspondence:

1a March 17, 2004. Memorandum from District Engineer to Construction Administrator

1b March 22, 2004. Memorandum from Construction Administrator to District Engineer

Change Order Approval

- Click the **SiteManager Panel** icon (the **Change Order Maintenance (+)** tab will be active).
- Double-click the **Header** icon.

The **Header** window will re-open.

- Press the pull-down menu in the **Status:** field, and select "Pending".
- Press the **Save** icon.
- The **AASHTO SiteManager** window will open, confirming the change in status. Click **Yes**. The **Change Order #000 Approval** window will open.
- Click the **New** button. SiteManager will assign a **Seq. No.**, and the line will be highlighted.
- Click the pull down menu under the **Groups for Approval** column.
- Scroll down, and select "Project Engineer".
- Click the pull down menu under the **User ID** column.
- Scroll down, and select your Project Engineer's name.
- Click the **New** button.

SiteManager will assign another **Seq. No.**, and the line will be highlighted.

- Click the pull down menu under the **Groups for Approval** column.
- Scroll down, and select "District Finals".
- Click the pull down menu under the **User ID** column.
- Scroll down, and select the name of the office staff who reviews Change Orders.
- Click the **New** button.

SiteManager will assign another **Seq. No.**, and the line will be highlighted.

- Click the pull down menu under the **Groups for Approval** column.
- Scroll down, and select "Supervising Engineer".
- Click the pull down menu under the **User ID** column.
- Scroll down, and select the name of your Supervising Engineer.
- Click the **OK** button.
- The **AASHTO SiteManager** window will open, informing you that mail has been sent. Click **OK**.

Your Project Engineer will be notified of the pending CO through the SiteManager Mail Box.

Change Order Reports

- Click on the **SiteManager Panel** icon (the **Change Order Maintenance (+)** tab will be active).
- Double click on the **Change Orders(+)** tab.
- Double click on the **Process List** icon. The **Process List** window will open.
- Double click "COKADK". The **Confirm Process Submission** window will open.
- Click **Subset**. The **Select Subset** window will open.
- Highlight the **Change Order** to be printed.
- Click **OK**. The **Confirm Process Submission** window will re-open.

- Click the **Parameters** button. The **Process Submission Parameters** window will open.
- Click **OK**. The **Confirm Process Submission** window will re-open.
- Click **Submit**.
- A window opens stating, **Process COKADKA submitted**.
- Click **OK**.
- A window opens stating, **Profile COKADKA for process COKADK has completed**. Click **OK**. The **Process List** window will re-open.
- Click **Services** on the upper **Toolbar**.
- Choose **Process Status**. The **Process Status** window will open (the **Regular** tab will be active).
- Double click the “COKADKA” choice under the **Process Name** heading. The **Files for Process COKADKA** window will open.
Double click the “Output.html” choice under the **Name** heading. The **Change Order Report** window will open.
- Click the **Print** icon to print the report.
- Attach this report to your CO Routing Slip.

Section Seven – Labor Wage Checks

Labor Wage Checks

It is advisable to select your contract upon entering SiteManager:

- Double click the **Contract Administration (+)** icon.
- Double click the **Contract Records (+)** icon.
- Double click the **Contracts (or Projects)** icon.
- Click the **File** pull-down menu, and then click **Open**. The **Select Contract** window will open.
- Double click your appropriate **Contract ID**.

All **Labor Wage Checks** that you enter from this point will be related to your contract.

Enter New Labor Wage Checks

- Click the **Main Panel** icon.
- Click the **Main Panel** tab.
- Double click the **Contract Administration (+)** icon.
- Double click the **Contractor Management (+)** icon.
- Double click the **Document Submission** icon. The **Document Submission** window will open.

If you began this section by selecting the contract as listed above, the contract number will be listed within the **Contract ID:** field. Also, the next **Document** will be listed in sequential order within the **Document Serial No:** field.

Enter information in the listed fields as follows:

- **Contract ID:** As with other aspects of SiteManager, grayed areas are non-enterable.
- **Document Serial No.:** As with other aspects of SiteManager, grayed areas are non-enterable.
- **Submitted By:** Enter the name of the inspector/consultant by using your SiteManager user ID that took the **Labor Wage Check**.
- **On:** Manually input the six-digit date.
- **Document Type:** Choose the following document type from the dropdown screen: “CON-131 Labor Wage Check Form”.

- **Document Category:** Choose the following document category from the dropdown screen: “EEO/DBE/OJT/SBE”.
- **Description:** Enter the **Labor Wage Check** information according to the following format: “Employee Name”, “Contractor’s Name”. “Complies to wage requirements” – if the Contractor complies. “Does NOT comply to wage requirements, ConnDOT District EEO officer notified” – if the Contractor does not comply.
- Click **Save**

To enter additional **Labor Wage Checks**, click the **New** icon and repeat the above navigation.

Modify or Check an Existing Labor Wage Check

- Double click the **Main Panel** icon.
- Click the **Main Panel** tab.
- Double click the **Contract Administration (+)** icon.
- Double click the **Contractor Management (+)** icon.
- Double click the **Document Submission** icon. The **Document Submission** window will open.

If you began this section by selecting the project as listed above, the contract number will be listed within the **Contract ID:** field. Also, the next **Document** will be listed in sequential order within the **Document Serial No:** field.

- Click the **Open** icon. The **Document Submitted Select** window will open.
- Double-click on the selected **Document S. No.** The **Document Submission** window will open with the requested **Document** active.

After any modifications are made to the **Document**, click **Save**

Section Eight – Contractor Payrolls

Entering Payroll Information

It is advisable to select your contract upon entering SiteManager:

- Double click the **Contract Administration (+)** icon.
- Double click the **Contract Records (+)** icon.
- Double click the **Contracts (or Projects)** icon.
- Click the **File** pull-down menu, and then click **Open**. The **Select Contract** window will open.
- Double click your appropriate **Contract ID**.

All **Payrolls** that you enter from this point will be related to your contract.

- Click the **Main Panel** icon.
- Click the **Main Panel** tab.
- Double click the **Contract Administration (+)** icon.
- Double click the **Contractor Management (+)** icon.
- Double click the **Contractor Payrolls** icon. The **Contractor Payrolls** window will open.

If you began this section by selecting the contract as listed above, the contract number will be listed within the **Contract ID:** field. Otherwise, enter your contract number.

For the first payroll of a contractor entered on a contract.

- Click the **Services** dropdown menu.
- Select **Choose Keys**. The **Select Payroll for Vendor** window opens.
- Double click the **Vendor Full Name**. The **Contractor Payrolls** window will reopen with the selected

Vendor ID: field filled in.

- Enter the correct date in the **Payroll Received:** field.
- Enter the correct date in the **For Period Ending:** field.
- Check the box for **Certified** if there are employees hours for that period
- Click the **Save** icon. A window reopens stating “Payroll Date reset according to the Payroll frequency of the Prime”
- Click **OK**.

Once the first payroll of a contractor for the contract is entered:

- Open an existing contractor payroll on the contract
- Click the **New** icon
- The **Contractor Payrolls** window will open with the selected **Vendor ID:** field filled in.
- Enter the correct date in the **Payroll Received:** field.
- Enter the correct date in the **For Period Ending:** field.
- Check the box for **Certified** if there are employees hours for that period
- Click the **Save** icon. A window reopens stating “Payroll Date reset according to the Payroll frequency of the Prime”
- Click **OK**.

Enter additional Payrolls for the Same Contractor

- Click the **New** icon.
- Enter the correct date in the **Payroll Received:** field.
- Enter the correct date in the **For Period Ending:** field.
- Check the box for **Certified** if there are employees hours for that period
- Click the **Save** icon. A window reopens stating “Payroll Date reset according to the Payroll frequency of the Prime”
- Click **OK**.

Enter Certified Payrolls for a Different Contractor

- Click the **Services** dropdown menu.
- Select **Choose Keys**. The **Select Payroll for Vendor** window opens.
- Double click the **Vendor Full Name**. The **Contractor Payrolls** window will reopen with the selected **Vendor ID:** field filled in.
- Enter the correct date in the **Payroll Received:** field.
- Enter the correct date in the **For Period Ending:** field.
- Check the box for **Certified** if there are employees hours for that period
- Click the **Save** icon. A window reopens stating “Payroll Date reset according to the Payroll frequency of the Prime”
- Click **OK**.

Deleting a Payroll

Select contract number

Select vendor full name

Select which date you want to delete

Uncheck **Certified** if there are no employees hours for that period

Then a box will appear. **Uncertifying payroll permits changes to this payroll associated data.**

Click **OK**

Click **Save**

Message box will appear. **Do you wish to delete this payroll data?**

Click **Yes**

Click **Save**

It should be noted that there are several tabs on the Payroll entry section of the Civil Rights area in SiteManager. Should the user wish to enter additional information, they have the option of choosing the Employee Information tab or the Employee Daily Information tab. Care should be used when entering this information.

For example: The Employee Information tab allows for individual employee information to be entered. All fields are required in order for the record to be saved. **UNDER NO CIRCUMSTANCES SHOULD THE EMPLOYEES ACTUAL SOCIAL SECURITY NUMBER BE ENTERED ON THIS SCREEN.** Please use a “dummy” or fictional nine digit number in this space. Start with 000-00. Social Security Numbers are required to accompany certified payrolls on Federal participating contracts. SSN are to be kept confidential at all times and not made immediately available for public viewing.

Section Nine – Contractor Ratings

Contractor Ratings

To add a contractor rating to SiteManager

On the **Main Panel**, double-click **Contract Administration(+)** icon

Double click the **Contract Management(+)** icon

Double click the **Contractor Evaluation** icon

In the **Contract ID** list box, scroll to and double-click the **Contract ID**.

Evaluation Date: use the date from the inspector rating.

Contractor: choose contractor from the drop down menu.

Rating: Enter Overall Performance Rating.

Begin Date: 01/01/xx (xx is the **Evaluation Year**).

End Date: 12/31/xx (xx is the **Evaluation Year**).

Contract Evaluated Ind: check box for sub-contractor, or leave unchecked for prime contractor.

Work Description: enter prime or sub, then enter final, annual or interim.

If the person entering the rating into SiteManager is not the person that prepared it, click the **Remarks** icon  and enter the evaluator name.

If there are comments at the bottom of the rating, click the **Remarks** icon  and enter “see rating for comments” or enter the actual comment, if it is short.

Click the **Save** icon.

If you wish to continue entering contractor ratings for the same contract, click New. 

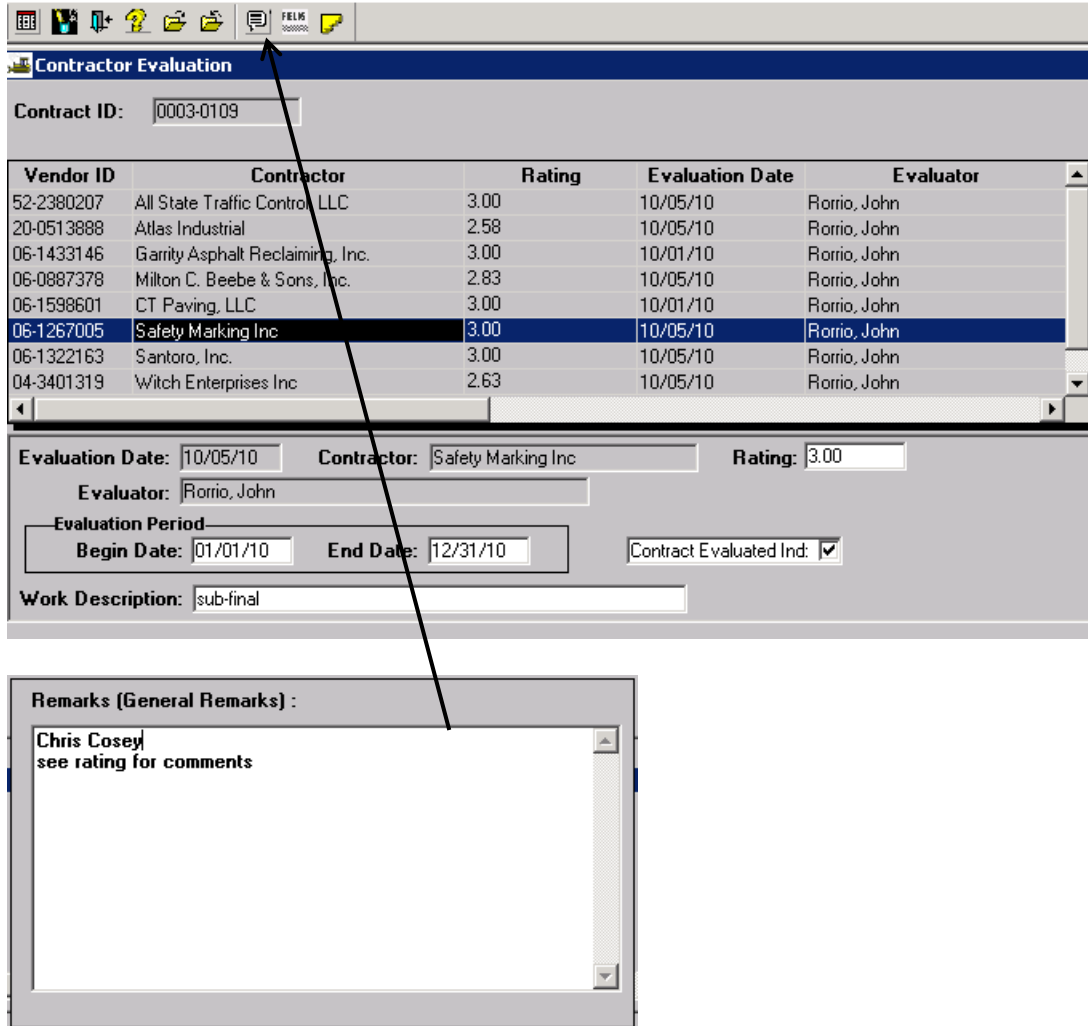

Section Ten – Subcontractor Approvals (Office of Construction)

Subcontractor Approvals

After checking the CLA-12 for completeness

On **Main Panel**, double-click **Contract Administration(+)** icon
 Double-click **Contract Management(+)** icon
 Double-click **Subcontracts** icon. The **Subcontracts** panel will open

If a subcontract has been previously entered for that contract

Click **File > Open**
 The **Select Contract** panel opens
 In the **Contract ID** list box, scroll to and double-click the **Contract ID**
 The panel displays a list of Subcontracts
 In the Subcontract list box, scroll to and double-click **any** existing Subcontract
 The panel displays data for the selected Subcontract
 Click **New**

If a subcontract has not been previously entered for that contract

Click **Services > Choose Keys**

The **Select Contract** panel opens

In the **Contract ID** list box, scroll to and double-click the **Contract ID**

Enter **SubCont Nbr** (For the first subcontractor on the contract, use 001. If not, then use the next number not used)

Enter **Parent Subcont Nbr** (if applicable, i.e. "sub of a sub")

In the **Subcontractor** field, right-click and click **Search**

In the **Search Window** list box, scroll to and double-click the **Vendor Short Name**

From the drop down list, choose **SubCont Type**

From the drop down list, choose **Miscellaneous** for **Work Type**

(Only exception is if it is a trucker, choose **Hauler** as **Work Type** and check box for **Supp/Hauler**)

Ignore message box and click **OK**

From the drop down list, choose **DBE Type**.

(**SMALL BUSINESS ENTERPRISE** or **DISADVANTAGED BUSINESS ENTERPRISE**)

IF NA, leave as **Spaces**

Enter **Approved Date**

Enter **Effective Date** (same as **Approval Date**)

Click **Save**

(If needed to save, enter 12/31/49 as the **Expiration Date**)

To add the items for the subcontractor

Click the **Items** tab

Click **New**

Choose **Prj Nbr** from drop down

In the **Line Item** field, right-click and click **Search**

In the **Search Window** list box, scroll to and double-click the Item Code

Press the Tab key

In the **This Subcontract** row, enter the quantity of the line Item subcontracted to this Subcontract below **Quantity**

To change the unit type for the **Quantity**, choose the unit type from the **Unit** drop-down list.

In the **Price \$** field, enter the unit price of the line Item

Click the **Save** button

To enter another item for that subcontractor, click **New** and repeat the process

DELETING AN ITEM FROM A SUBCONTRACTOR IN SITEMANAGER

To delete an Item from a Subcontractor:

On Main Panel, double-click **Contract Administration** icon

Double-click **Contract Management** icon.

Double-click **Subcontracts** icon. The Subcontracts panel opens.

Click the **File > Open**.

The **Select Contract** panel opens.

In the **Contract ID** list box, scroll to and double-click the **Contract ID**.

The panel displays a list of Subcontracts,

In the Subcontract list box, scroll to and double-click **Subcontractor**.

The panel displays data for the selected Subcontract.

In the Subcontract list box, scroll to and click the **Subcontract**.

Click **OK**. The panel displays data for the selected Subcontract.

Click **Items** tab.

In the **Items** list box, scroll to and click the Item.

Click the **Delete** button. The system asks the user to confirm the deletion.

Click **Yes**.

Click the **Save** icon.

NOTE: To add or update vendors/contractors, email the OOC SM administrator. Changes are made in Web-Transport (Pre-Construction), and then exported to SiteManager.

Inspector should use the **Listing of Subcontractor Approvals and Start Dates** report to check the status of a subcontractor approval on a contract.

Section Eleven – New Contracts in SiteManager (SM Administrators)

Before any work can be done on a contract, it must first be imported into SM.

Importing a New Contract into SiteManager

- First, the **Office of Contracts** unit will export a new contract from **Web-Transport**.
- Log into SiteManager and choose the **SiteManager Administrator** role.
- Double click **System Administrator**
- Double click **Process List**
- Double click **Pre-construction Contract Load**
- Click **Submit**
- Wait for “**Profile BPRELOADA for process SMBAPP has completed**” message.
- From the main panel, choose **Contract Administration (+)**, then select **Contract Records (+)**, and finally open the **Contracts** window.
- The new contract should now be in **SiteManager** with a **Pending** status.
- Notify **Office of Contracts** if import to SM was successful or not.
- Notify the district SM representative when there is a new pending contract in SM.

Contract Activation

NOTE: Do not “flip” LS items while a contract is still PENDING.

NOTE: Before entering data from the contract, check to see if the **Insurance and Surety (Bonding) Companies are on the Vendor Master List**. If not, the OOC SM administrator will add them to the list using **Web-Transport**. Also check to see if the **Insurance and Surety Companies are associated to the Prime Contractor on the Vendors Window**.

Municipal Contracts

Municipal contracts are entered into SM from scratch so very basic information can help populate reports. SM is not used for DWRs, Material Testing, COs, estimates, etc.

ADDING MUNI PROJECTS TO SM

Basic information shows up earliest on the advertising report.
The first 3 pages must be done before saving for the first time.
Contracts can be entered little by little or all at once when a CON-100(start) is received

Contract Administration > Contract Records > Contracts

Start with a blank screen or click **New**

DESCRIPTION TAB

Contract ID: enter contract number

Fed St/Pr Prj Nbr: enter MUNI

District: choose district number from the dropdown menu

Section: choose T from the dropdown menu

Progress Sched: leave blank

Desc: enter contract description from advertising report

Time Charges: choose **CALENDAR DAYS** from the dropdown menu

Contract Type: choose **Biddable Contract** from the dropdown menu

Work Type: choose **TO BE DETERMINED** from the dropdown menu

Spec Yr: enter **1999 (unless the actual Spec Year is known)**

Unit System: choose English from the dropdown menu

Funding: click **Federal** box (almost always, if need be, update before contract is activated)

Click **Local Oversight** box

Variance Pct: enter **20**

Bid Days: if not known yet, enter **1** and update (before activation) when you have the correct info

Wage Decision:

Click box

Click **New**

Right click on new space below **Wage Decision ID**

Choose **Search** from the dropdown menu

Click **Wg Dcsn ID** column header

Click first entry (0000-0000 20120101 Generic Wage Decision. Please Use Generic)

Click **OK**

Contracts

Description Location Payment Data Critical Dates Primary Personnel Prime Contractor DBE Commit Training Plan

Contract ID: 0032-0145 Fed St/Pr Proj Nbr: MUNI
 Status: Pending Primary PCN: 0032-0145
 District: 1 Section: T
 Progress Sched: Variance Pct: 20.00
 Desc: Facility - Salt Shed
 Time Charges: CALENDAR DAYS Bid Days: 1 Bid Amt: \$1.00
 Contract Type: Biddable Contract
 Work Type: TO BE DETERMINED
 Funding: Federal State/Province Both
 Fed Oversight Local Oversight
 Proposal Fund Type:
 Spec Yr: 1999 Unit System: English Suppl Spec Bk Yr: Alt ID:

Wage Decision:	Wage Decision ID	Wage Decision Description	Genrl Wg Dcsn ID
	0000-0000	Generic Wage Decision. Please Use	Generic

LOCATION TAB

Location: repeat contract description

Town: enter town of project

Contract County:

Left click below Contract County:

Click **New**

In new space, right click and choose **Search** from the dropdown

Scroll down to bottom and choose the county name

Click **OK**

Click **Primary County** check box

Contracts

Description **Location** Payment Data Critical Dates Primary Personnel Prime Contractor

Contract ID: 0032-0145
 Location: Facility - Salt Shed
 Beg Sta Nbr: Beg Termini: Route Nbr:
 End Sta Nbr: End Termini: Highway Nbr:
 Road System: Spaces Highway Type: Spaces
 Town: Coventry
 Contract County: Tolland Primary County:

PAYMENT DATA TAB

Generate Est1 Day: enter 1

Unclick any boxes under RETAINAGE

Below Retainage Changes, all numbers should be 0, except the **Effect Date**

Contracts

Description	Location	Payment Data	Critical Dates	Primary Personnel	Prime Contractor	DBE Commit	Training Plan	
Contract ID: 0032-0145		Current Contract Amt: \$1.00		Generate Est1 Day: 1		Contract Limit Amt: \$0.00		
Generate Est2 Day:		Contract Limit Pct: .00		Liquidated Dam Rate Amt: \$0.00		<input checked="" type="checkbox"/> Auto Liquidated Dam		
						<input type="checkbox"/> Price Adjmnt Ind		
RETAINAGE								
<input type="checkbox"/> Securities Allowed		<input type="checkbox"/> Retain Stkpled Ind		<input type="checkbox"/> Unlimited Escrow		Max Escrow Amt: \$0.00		
Retainage Changes:								
Work Compl Basis	Effect Date	Pct	Pct Base	Max Pct	Max Amt	Lump Amt	Trgr Pct	Trgr Base
WORK IN PLACE	07/28/16	.00	BID AMT	.00	\$0.00	\$0.00	.00	BID AMT

PRIMARY PERSONNEL TAB

Project Manager: enter **msat**

Project Engineer: enter **msat**

Contracts

Description	Location	Payment Data	Critical Dates	Primary Personnel	Prime Contractor	DBE Commit	
Contract ID: 0032-0145		Project Manager: msat MSAT		Project Engineer: msat MSAT		Contract Designer:	
Contract Created By: Florrio, John H.							

PRIME CONTRACTOR TAB

Current Prime: Right click in space, and click **Search** from the dropdown menu

If known, choose prime contractor

If not known yet, temporarily choose 00-0005000 DEPARTMENT OF TRANSPORTATION

(must be updated before contract is activated)

Add 1 surety and 1 insurance company (ANY)

Click **Save**

DBE COMMIT TAB

DBE Goal Percent: enter DBE/SBE goal for prime contractor

(if not known, info can be entered later, even after activation)

Click **Save**

Contracts

Description	Location	Payment Data	Critical Dates	Primary Personnel	Prime Contractor	DBE Commit	
Contract ID: 0159-0189		DBE Work Class: Spaces		DBE Goal Percent: 13.00		DBE Goal Value: \$270,350.13	
<input type="checkbox"/> DBE Commitment							

Other things that can be done before activation

Main Panel > Contract Administration > Contract Records > Projects
 Description Tab

Project Nbr: enter contract number
Fed St Prj Nbr: enter MUNI
Location: enter Town
 Click **Save**

Projects

Description Counties Adjustment Indices

Contract ID: 0159-0189

Project Nbr: 0159-0189 Fed St Prj Nbr: 1159(105)

Description: Rehab of Bridge No. 00807, Ridge Road over Route 5/15

Description:

Status: Active Complete
 Release Retainage

Prj Type: Spaces Work Type: STRUCTURAL CONC

Route Nbr: Sect Nbr:

Road Name: Ridge Road

Location: Wethersfield

Location:

Main Panel > Contract Administration > Contract Records > Categories
 Click **New**
Catg Nbr: enter 01
Fed St/Pr Prj Nbr: enter MUNI
Desc: enter description of the contract
 Click **Save**

Categories

Contract ID: 0159-0189 PCN: 0159-0189

Category Number	Description
0001	Rehab of Bridge No. 00807, Ridge Road over Route 5/15

Catg Nbr: 0001 Fed St/Pr Prj Nbr: 1159(105)

Desc: Rehab of Bridge No. 00807, Ridge Road over Route 5/15

Main Panel > Contract Administration > Contract Records > Items

Page should be blank, but if not, click **New**

Category Nbr: choose 01 from the dropdown menu

Line Item Nbr: enter 0010

Item Code: enter CO00281 (Description will fill in automatically)

Bid Qty: enter original bid amount (if not known, enter 1 and update before contract activation)

Unit Price: enter 1

Click **Save**

Main Panel > Contract Administration > Contract Records > Funding

Funding Source Code: choose OPAR from the dropdown (almost always fed \$)

Funding Source Description: enter Participating

Source Participation Percent: enter 100

Priority Order: enter 1

(Bid Amount will now show up on the description tab)

Click **Save**

Contract ID	Project Number	Category Number	Line Item Number	Funding Source Code	Funding Source Description	Priority Order	Source Participation Percent
0032-0145	0032-0145			OPAR	Participating	1	100

THESE STEPS CAN BE DONE AT ANY TIME WHILE THE CONTRACT IS PENDING

Before activating, all info must be updated (calendar days, bid amount etc.)

Before activating a muni contract, all of the dates that are **Required to Activate** on the **Critical Dates** tab must be entered (Info can be obtained from the CON-100 (start) or muni charts)

CRITICAL DATES TAB

Notice to Proceed Date: from CON-100 (if this gets entered, then contract has to be activated)

Execution Date: not known, enter Award Date

Award Date: enter Award Date

Letting Date: not known, enter Award date

Work Begin Date: enter actual contractor start date

Click Save

Contracts

Description Location Payment Data **Critical Dates** Primary Personnel Prime Contractor

Contract ID: 0032-0145

Critical Date Description	Actual Date	Required to Activate
Contract Items Complete Date	00/00/00	N
Physical Work Complete Date	00/00/00	N
Notice to Proceed Date	00/00/00	Y
Contractor Final Release Date	00/00/00	N
Open to Traffic Date	00/00/00	N
Signed Date	00/00/00	N
Contractor Default Date	00/00/00	N
Execution Date	00/00/00	Y
Contract Archived Date	00/00/00	N
Adjusted Completion Date	00/00/00	N
Original Completion Date	00/00/00	N
Letting Date	00/00/00	Y
Checked Out to Field Date	00/00/00	N

Critical Date Description: Contract Items Complete Date

Actual Occurrence Date: 00/00/00 Required to Activate Required to Activate

Distribution List: Required to Activate

On Description Tab

Status: change from Pending to Active

Click Save

Contract is now activated

NOTE: The steps to create and activate an **Emergency Declaration Job** are similar to a municipal contract.

As information is received, enter **Key Dates** and **Critical Dates**
(including CON-100 (complete), CON-500, CON-501)

ONCE THE FINAL PACKAGE IS RECEIVED AND FINAL CONTRACT AMOUNT IS KNOWN

Enter 1 DWR

Double-Click **Item Code** CO00281

Daily Work Reports

DWR Info. Contractors Contractor Equip. Daily Staff **Work Items** Force Accounts

Contract ID: 0049-0108 Inspector: Porrio, John H. Date: 05/03/18

Instd	Project Number	Line Item Number	Proposal Line Number	Category Number	Category Description	Item Code	Description
<input checked="" type="checkbox"/>	0049-0108	0010		01	Safety Improvements - Essex	CO00281	For Municipality use only

Placed Qty: enter final contract amount

Measured Indicator = click N

Contractor: choose prime contractor from the dropdown menu (should be only choice)

Daily Work Reports

DWR Info. Contractors Contractor Equip. Daily Staff **Work Items** Force Accounts

Contract ID: 0049-0108 Inspector: Rorrio, John H. Date: 05/03/18

Project Nbr: 0049-0108 Line Itm Nbr: 0010 Prpsl Line Nbr: Item Code: C000281 Category Nbr: 01

Item Desc: For Municipality use only Unit Price: \$1.00000

Supp Desc 1: municipal

Supp Desc 2:

Qty Reported to Date: 219,168.650 Qty Authorized to Date: 219,168.650 Units Type: l.s.

Qty Installed to Date: 219,168.650 Bid Qty: 218,502.000 Pay To Plan Qty:

Status: Complete Qty Paid to Date: 219,168.650 Current Contract Qty: 219,168.650

Loc Seq Nbr	Location Installed	Placed Qty.	Plan Page Number	Templ Used
1	on site	219,168.650	0	<input type="checkbox"/>

Placed Qty: 219,168.650 Plan Page Nbr: 0 Contractor: Clover Construction Corporation ** PRIME **

As Built Qty: .000 Loc Seq Nbr: 1 Location: on site

Station Offset Distance Station Offset Distance Measured Indicator

From: + .000 To: + .000 Y N

Material Inspection Detail

Click **Save**

Enter 1 Diary to approve the previously entered DWR

Click **Save**

Diary

Authorize Charge

Contract ID: 0049-0108

Diary Date: 05/03/18 Last Modified User ID: rorrioj Creator User ID: rorrioj

Inspector	Authorized	Authorized Date	DWR Template
Rorio, John H.	<input checked="" type="checkbox"/>	05/03/18	<input type="checkbox"/>

Remarks:

General

- Accident
- Compliance Notice
- EEO Issues
- Environmental
- Lane Closures
- Meetings
- Non-Compliance Notice
- Personnel Remarks
- PE Record Review
- Possible Cost Plus
- Possible Dispute or Claim
- Railroad Force Account
- Safety Violations
- Trafficperson

Spell Check

Generate and approve 1 estimate

Estimate Tracking

Contract ID: 0049-0108 Estimate Nbr: 0001

	Date	Time	User ID
Generated	05/03/18	15:23:43	rorrioj
Project Manager	05/03/18	15:24:16	rorrioj
Project Engineer	05/03/18	15:25:12	rorrioj
Supervising Engineer	05/03/18	15:25:12	rorrioj
ADE - Final Approval	05/03/18	15:25:52	rorrioj
Est. Paid in CORE Only	05/04/18	12:38:24	rorrioj

Create 1 CO to change item CO00281 from original bid of contract to final amount of contract

Change Order Items

Header Items Time Adjustments Explanations

Contract ID: 0049-0108 Change Order Nbr: 001 Status: APPR

Project Nbr	Catg Nbr	Item Nbr	Item Code	Description
0049-0108	01	0010	CO00281	For Municipality use only

Project Nbr: 0049-0108 Category Nbr: 01 Line Item Nbr: 0010 Item Code: CO00281

Units Type: l.s. Spec Year: 2000 Major Item: Specialty: Status Type: CMPL

Unit Price: \$1.00000 Proposal Line Nbr: Related Item: Standard Item

Item Desc: For Municipality use only Critical:

Suppl Desc: municipal Pay Plan Qty:

CO Item Desc: Material Discrepancy Adj:

Suppl Desc Req'd:

	Quantity	Amount
Contract Bid:	218502.000	\$218,502.00
Approved Change Order:	666.650	\$666.65
Current Contract:	219168.650	\$219,168.65
Pending Change Order:	0.000	\$0.00
This Change Order:	666.650	\$666.65

Force Account Item

Status: Move to **Draft**, and then **Approve**
Click **Save**

Change Order Header

Header Items Time Adjustments Explanations

Contract ID: 0049-0108 Change Order Nbr: 001 Status: APPR

Tentative Verbal Approval Dates:
Federal: 00/00/00 Local: 00/00/00

CO Created by: Porrio, John H. On: 05/03/18

Status: APPR Approval Level: Supervising Engineer

Description: x

Reason Code: Extra Work

CO Type: Final Change Order

Override Approval Rules Emergency Work

Functions:
 Overrun/Underrun Force Account
 Extra Work Zero Dollar
 Time Adjustment Final Quantity

Bid Contract Amt: \$218,502.00
Current Contract Amt: \$219,168.65
CO Amount: \$666.65

Reference to:

Fill in all required critical dates

Click **Save**

Contracts			
Description	Location	Payment Data	Critical Dates
Contract ID: <input type="text" value="0049-0108"/>			
Critical Date Description	Actual Date	Required to Activate	Required to Finalize
Contractor Final Release Date	00/00/00	N	N
Contractor Bankruptcy Date	00/00/00	N	N
Adjusted Completion Date	12/24/16	N	N
Original Completion Date	12/24/16	N	N
Signed Date	00/00/00	N	N
Checked Out to Field Date	00/00/00	N	N
Price Adjustments Base Date	00/00/00	N	N
Execution Date	05/31/16	Y	N
Physical Work Complete Date	04/24/17	N	N
Letting Date	04/12/16	Y	N
Contract Items Complete Date	04/26/18	N	Y
Substantial Work Complete Date	09/23/16	N	Y
Work Begin Date	06/08/16	N	Y

Fill in all required **Key Dates**
Click **Save**

Key Dates				
Contract ID: <input type="text" value="0049-0108"/>				
Key Date Type	Projected Date	Actual Date	Required to Activate	Required to Finalize
Estimated Completion Date	09/23/16	09/23/16	N	Y
Acceptance Date - Progress Report	04/26/18	04/26/18	N	Y
Finals-Material Certification Given	12/28/16	12/28/16	N	Y
Finals-CON100 Notice of Completion	09/23/16	09/23/16	N	Y
Finals-CON500 Cert. of Accep. of Work	04/24/17	04/24/17	N	Y
Finals-CON501 Cert. of Accep. of Project	04/26/18	04/26/18	N	Y
Final Inspection	04/24/17	04/24/17	N	Y

From dropdown menu, switch from **Active** to **Complete**
Click **Save**

Contracts							
Description	Location	Payment Data	Critical Dates	Primary Personnel	Prime Contractor	DBE Commit	Training
Contract ID: 0059-0161		Fed St/Pr Proj Nbr: MUNI 1059(110)		Primary PCN: 0059-0161			
Status: Active	District: Active	Section: T		Variance Pct: 20.00		Funding <input checked="" type="radio"/> Federal <input type="radio"/> State/Province <input type="radio"/> Both	
Progress Sched: Archived	Desc: Complete & Drainage of Long Hill Road			Bid Days: 360		Bid Amt: \$3,324,667.20	
Time Charges: Pending							

Contract is now accepted

Section Twelve – Contract Finalization (SM Administrators)

Contract Finalization

If there are any contract items that are not balanced, a change order will be needed.

All **Required to Finalize** dates must be entered into SM.

Key Dates

Key Dates				
Contract ID: 0999-0999				
Key Date Type	Projected Date	Actual Date	Required to Activate	Required to Finalize
Acceptance Date - Progress Report	00/00/00	00/00/00	N	Y
Finals-Material Certification Given	00/00/00	00/00/00	N	Y
Finals-CON100 Notice of Completion	00/00/00	00/00/00	N	Y
Finals-CON500 Cert. of Accep. of Work	00/00/00	00/00/00	N	Y
Finals-CON501 Cert. of Accep. of Project	00/00/00	00/00/00	N	Y
Final Inspection	00/00/00	00/00/00	N	Y
Estimated Completion Date	00/00/00	00/00/00	N	Y

NOTE: The **Estimated Completion Date** (Projected Date) should be filled out manually as the contract progresses.

Critical Dates

Contracts						
Description	Location	Payment Data	Critical Dates	Primary Personnel	Prime Contractor	DBE Commit
Contract ID: 0004-0116-R1						
Critical Date Description	Actual Date	Required to Activate	Required to Finalize			
Work Begin Date	00/00/00	N	Y			
Substantial Work Complete Date	00/00/00	N	Y			
Contract Items Complete Date	00/00/00	N	Y			

Change the Status: (on the Description tab) of the Contract from **Active** to **Complete**.
 Click **Save**.
 All entries will then be greyed out and no more changes can be made to the contract.

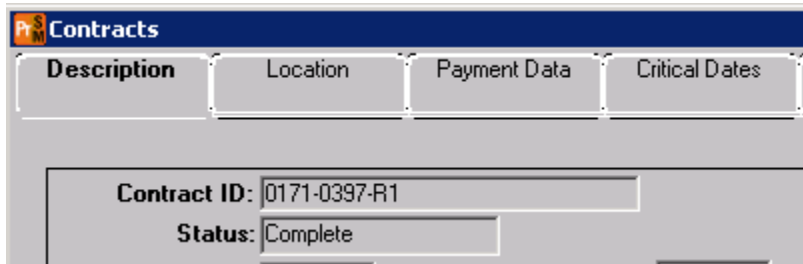

DISTRICT SM REPRESENTATIVES

District 1	Darlene Salokas	860-258-4644	Darlene.Salokas@ct.gov
District 2	Jim Paul	860-823-3269	Jim.Paul@ct.gov
District 3	John Kaliszewski	203-389-3193	John.Kaliszewski@ct.gov
District 4	Michael Richardson	203-591-3559	Michael.Richardson@ct.gov
District 5	Momar Ndao	203-401-5166	Momar.Ndao@ct.gov
Rails	Manesh Dodia	203-497-3360	Manesh.Dodia@ct.gov
DMT	David Parillo	860-258-0389	David.M.Parillo@ct.gov

OFFICE OF CONSTRUCTION SM ADMINISTRATOR

OOC	John H. Rorrio	860-258-4643	John.Rorrio@ct.gov
-----	----------------	--------------	--

The preferred method of SiteManager support is to email your district representative and cc: the OOC administrator. If the problem is related to materials and/or testing, also cc: the DMT representative.

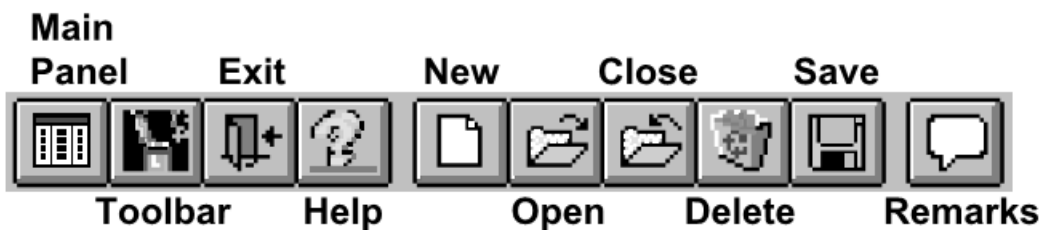

Appendices

Appendix B - Update Procedures

B-100 General

This appendix discusses the update procedures established for revisions to the *Construction Manual*. Also, contained in this appendix is the form required to suggest a revision to the *Standard Specifications for Roads, Bridges, Facilities and Incidental Construction*.

The Construction Manual was developed to establish quality control for Department personnel in the practices, policies, and procedures for inspecting and documenting construction projects. Because inspection and documentation practices and procedures undergo changes through time, this manual must likewise undergo changes to retain its usefulness as a comprehensive, up-to-date administrative and technical reference. Manual updates may be required by changes in:

- construction techniques and procedures
- administrative procedures
- operating practices, and
- Organizational structure, responsibilities, and relationships.

To ensure orderly, logical, and timely updating of the manual, certain responsibilities must be designated and specific procedures must be followed. These responsibilities and procedures are set forth in this appendix.

B-101 Responsibilities

The Construction Division Chief will have basic responsibility to make sure the content of the Construction Manual is kept current. To help achieve this, the Construction Division Chief will appoint a Construction Manual Committee and a Construction Manual Coordinator.

B-102 Construction Manual Committee

The Construction Manual Committee will consist of six to eight selected Department personnel with responsibilities for and demonstrated expertise in construction. Committee members will meet periodically to (1) deliberate the merits of proposed revisions or additions, (2) determine the exact form of proposed changes, and (3) submit recommended changes to the Construction Division Chief for review and approval and (4) to ensure the manual is properly updated and current with existing Directives, Bulletins and memorandums.

The committee will consist of a representative from the Office of Construction, representatives of each of the Construction Districts and the Division of Materials Testing, and other key Department employees who have specialized background and knowledge in particular fields related to construction, maintenance, design, traffic, and materials. A representative from FHWA should be invited to committee meetings.

B-103 Construction Manual Coordinator

The Construction Division Chief will designate an individual to serve as the Construction Manual Coordinator, charged with managing the updating of the manual. Between committee meetings, the Coordinator receives all suggested changes to the manual and streamlines the committees work in advance by grouping and consolidating the suggestions onto the meeting minutes. Suggested revisions should be submitted to the Construction Manual Coordinator in the format shown in Figure B-1.

Figure B-2 List of Revisions

Construction Manual Revision List List of Construction Bulletins/Directives/Memorandums/Suggestions Revisions Version X.X		
New Moved to Minutes Edits Completed		
Note as: new, moved to minutes, completed. Note as: a revision, addition or deletion Note as: urgent or normal Note: Submitted by – Brief Description		
Construction Bulletin No. Description	Date	Volume/Chapter/Section

The Coordinator sees that the adopted changes are prepared in final format after obtaining necessary approvals, checked for correctness, and posted on the Department’s network for access via computer. The Coordinator also maintains a current List of Revisions, Figure B-2. Revision changes will consist of the version number, month and year. For example, ver. 3.0 January 2017.

B-104 Types of Changes

Over time, several different types of changes to the manual can be expected. These include:

- Revisions—changing the existing information or the way it is presented through modifications of procedures, techniques, organizational structure, responsibilities, and so forth.
- Additions—providing new information about an existing topic or addressing an altogether new subject not currently treated. This includes the insertion of tables, graphs, and other illustrations to clarify or expand on the information presented in the text.
- Technology Changes – updating or adding new methods based on new technologies.
- Deletions—removing information that is no longer correct or useful.

Regardless of the type of change, it is important that other chapters and sections of the manual be carefully reviewed to ensure that a change at one location does not conflict with other sections, charts, or tables in the manual.

Appendices

B-105 Sources of Changes

Changes to the manual come from several sources. Currently the Office of Construction uses Construction Bulletins and Construction Directives to indicate changes in procedures. Another generalized source can be construction practice and procedures, including changes in materials and work methods. Most of these changes will be initiated through reports documenting research and development done by AASHTO, FHWA, CFR's, TRB, and other recognized agencies. The Construction Manual Committee may periodically review these publications and discuss the merits of adopting the new or revised criteria.

Other sources are revisions to the standard specifications, memorandums, Construction Bulletins and Directives. These often evolve into normal but unofficial practices and procedures. By incorporating them, the Construction Manual assembles, consolidates, and standardizes them; makes them official; and puts them at the disposal of all inspection personnel and other manual users.

Individuals who regularly use the manual can provide valuable assistance in identifying needed updating and improvements. They do this individually by submitting their personal suggestions, and they do it collectively by demonstrating which parts of the manual are most used, which need expansion or simplification, and which procedures are obsolete.

B-106 Procedures for Making Changes to Construction Manual

Changes in the manual may be described as urgent or normal. Urgent changes include all those of a critical nature that call for immediate implementation of new criteria or procedures by issuance of a Construction Memorandum/Bulletin that will be in effect until the next manual update. Normal changes are those that can be accumulated for publication at regularly scheduled intervals.

The regular meeting of the Construction Manual Committee should be scheduled periodically and far enough in advance of the update publishing date to provide time to review, request approval and incorporate approved revisions.

When an urgent change is implemented by Construction Memorandum/Bulletin, the topic should be moved from the Revision List immediately to the Construction Manual Meeting Minutes to be discussed at the next Construction Manual meeting.

Drafts of proposed new or revised material are submitted to the Construction Division Chief for review and approval. In accordance with the current FHWA/DOT Stewardship Agreement, the Department will coordinate any required reviews or approvals with FHWA.

Changes to the manual should be written (and illustrated) in the same style as the original text. Updated material should be clear and concise. The Coordinator should take the lead in ensuring these qualities. When significant changes have occurred in a Volume, an intermediate version of that Volume will be issued. The various iterations of the Volume will have a label placed in the footer next to the chapter name along with a date for the version (i.e. ver. 2.3 April 2015, ver. 3.0 July 2016). Edit marks will be used in the intermediate versions to identify revisions.

As changes are made to the Construction Manual, the Table of Contents will be revised to show revision dates for figures, Sections or Chapters in the right hand column. Individual pages are not dated in the Table of Contents of the initial publication. However, when revisions are made to a page, or a new page is added, the revision date should be clearly shown in the Table of Contents. For example, "Rev April 2016." This will provide for easy distinction between unrevised and revised Construction Manual sections.

When suggestions and/or changes have been incorporated into the manual this should be summarized in a memorandum or Bulletin from the Construction Division Chief so that users will not have to search to identify them.

Appendices

B-107 Suggesting Revision to the Standard Specifications

All requests for the review of specification changes should be submitted to the Construction Division Chief by the District Engineer, Assistant District Engineer or an Office of Construction (OOC) Transportation Supervising Engineer using the recommendation memorandum.

The OOC Specification Section will review the proposed changes, and if deemed necessary, the Specification Section will arrange a meeting to discuss the proposal with the appropriate Standard Specification subcommittee.

If the OOC does not agree with the proposed specification change, a memorandum will be sent back to the proposer.

Appendices

Figure B-3 Recommended Revision to Standard Specifications Memorandum

STATE OF CONNECTICUT
DEPARTMENT OF TRANSPORTATION

subject: Standard Specification
Proposal -

Memorandum

date:

to: name
Chairperson
Standard Specifications Committee

from: name
title
Bureau of Engineering and
Construction

Attached is a proposed change to the Department's Standard Specifications.

The rationale for the proposed revision is:

Changed Section No(s):

Section # - title

Section # - title

Please check all applicable items.

- Previously used as a special provision.
If yes, how many years? _____

<= right click, "Properties"
"Default value: Checked"

Additional comments:

Specification coordinated with the following:

- Construction
 Maintenance
 Materials Testing Lab
 Design
 Attorney General's Office

Others (List):

- OOC Claims Unit
 Consultant Auditor

- Word version(s) attached to email

Attachments

author's initials

cc: Specification Section

Appendix C - List of Standard Correspondence

C-101 List of Standard Correspondence

Table C-1 List of Standard Correspondence

<u>CM CHPT</u>	<u>Reference</u>	<u>Description of Subject</u>	<u>Addressee</u>	<u>Preparer</u>	<u>Reviewer</u>	<u>Signer/ Approver</u>	<u>Signature Type (Digital/Electronic)</u>
1-1	Work Schedule	Work Schedule Change	Proj. Inspector	TE3	TSE	ADE	Electronic
1-1	Hazardous Duty	Hazardous Duty Request Form	DE	TE3	TSE	ADE	Electronic
1-1 & 2	Contract Start	Installation of Const. Field Office	Contractor	Chief	TE3	TSE	Electronic
1-1 & 7	Design Review	Design Review Comments	Prin. Design Eng.	PE	TSE	ADE	Electronic
1-1 & 20	Press Release	Press Release	Const. Div. Chief	Chief	TE3	TSE	Electronic
1-1 & 2-3	Safety & Blasting Meeting	Safety & Blasting Meeting Notice	Contractor/ Utility	Chief	N/A	TE3	Electronic
1-2	Pre-Con Notice	Pre-Construction Meeting Notice	Contractor	Chief	TE3	TSE	Electronic
1-2 & 22	Contract Start	Notice to Proceed (CON-100)	Contractor	Chief	TE3	DE	Electronic
1-2 & 22	Contract Start	Notice to Proceed	Utility Company	Chief	TE3	DE	Digital
1-3	Transmittal Memo	Working Drawings	Design	TE3	N/A	TE3	Electronic
1-3	Transmittal Letter	Working Drawings Comments	Contractor	TE3	TE3	TSE	Electronic
1-3	ECM	Design Question (No Contract Changes)	Design	Chief	TE3	Chief/TE3	Electronic
1-3	ECM Answer	Answer to Design Question (No Contract Changes)	Chief/TE3	Design	N/A	Designer	Electronic
1-3	RFI	Design Question (No Contract Changes)	Chief/TE3	Contractor	N/A	Contractor	Electronic
1-3	RFI Answer	Answer to Design Question (No Contract Changes)	Contractor	Chief/TE3	TE3	Chief/TE3	Electronic
1-3	RFC	Request to change Contract	ADE	Contractor	N/A	Contractor	Electronic
1-3	RFC Answer	Response to request to change Contract	Contractor	Chief	TE-3	SE (no \$) /ADE (\$)	Digital
1-3	Field Directive	Direction to Contractor	Contractor	Chief	N/A	Chief	Electronic
1-3 & 6	Request for Price	Extra Work Price Request	Contractor	Chief	TE3	TSE	Electronic
1-3 & 16	Interoffice Memo	Design Issue (Routine)	Design	TE3	TSE	TSE	Electronic
1-3 & 2-1	Env. Monthly Reports Env. Start/Stop	Letter for all other Interdepartmental Form STO-201 (DEP)	Regulatory Agency	Env. Coord.	N/A	DE	Digital

Appendices

Construction Manual Standard Correspondence

<u>CM CHPT</u>	<u>Reference</u>	<u>Description of Subject</u>	<u>Addressee</u>	<u>Preparer</u>	<u>Reviewer</u>	<u>Signer/ Approver</u>	<u>Signature Type (Digital/Electronic)</u>
1-4	Testing (Memo)	Insufficient Test Coverage or Rejected Material	Rocky Hill Lab	Chief	TSE/TE3	ADE	Electronic
1-5	Price Adjustment	Minor Item Adjustment	Contractor	TE3	TSE	ADE	Digital
1-5	Price Adjustment	Major Item Adjustment	Contractor	TE3	TSE/ADE	DE	Digital
1-6	Price	Agreed Price Approval	Contractor	Chief/PE*	TE3/TSE	ADE	Digital
1-7	Time Extension	Time Extension Analysis	ADE	Chief & TE3*	TE3	TSE	Electronic
1-7	Time Extension	Letter to Contractor	Contractor	TE3	TSE/ADE	ADE	Digital
1-8	Construction Orders Processed Unsigned	Construction Orders Processed Unsigned	Contractor	Office	N/A	TSE (Office)	Electronic
1-9 & 2-10	Repair Guiderail	Section of guiderail considered complete and functional	Contractor	Inspector	TE3	TE3	Electronic
1-10	Evaluations – Contractor	Contractor Performance Evaluation Rating Form	Const. Division Chief	Inspector	TE3	DE	Electronic
		Letter to Contractor			TSE	TE3	Electronic
1-10	Inspection Notice (Semifinal)	Semifinal Inspection Notice (inc. Partial)	Contr./Town/Utility	TE3	N/A	TSE	Electronic
1-10	Inspection Results (Semifinal)	Semifinal Inspection Results, Punch List(s)	Contractor	TE3	N/A	TSE	Electronic
1-10	Inspection Results (Final)	Final Inspection Results Memo	DE	TSE/Princ.*	N/A	ADE	Electronic
1-10	Project Closeout (1 st)	Final Project Closeout – (enclosures)	Contractor	Chief	N/A	TE3 (Finals Chief)	Electronic
1-10	Project Closeout (2 nd)	Final Project Closeout – (2 nd Request)	Contractor	TE3	N/A	TSE	Electronic
1-10	CON-100	Notice of Substantial Completion of Construction Work	Various	Chief	TE3	SE	Electronic
1-10	Substantial Completion	Letter Stopping Time	Contractor	TE3	TSE	ADE	Digital
1-10	Return of Maint. to Municipality		Municipality	TE3	TSE	DE	Digital
1-10	(Partial Relief of Responsibility)	Partial Relief of Responsibility - (with exceptions)	Contractor	TE3	TSE	ADE	Digital

Appendices

Construction Manual Standard Correspondence

<u>CM CHPT</u>	<u>Reference</u>	<u>Description of Subject</u>	<u>Addressee</u>	<u>Preparer</u>	<u>Reviewer</u>	<u>Signer/ Approver</u>	<u>Signature Type (Digital/Electronic)</u>
1-10	(Relief of Responsibility)	Relief of Responsibility (agree with CON-500)	Contractor	TE3	TSE	ADE	Digital
1-10	Final – Construction Report	Construction Report		Chief	TE3	ADE	Electronic
1-10	Final – Acceptance w/Docs. Pending	Acceptance of Project with Documents Pending	Const. Admin.	Chief	ADE	DE	Electronic
1-10	Final Acceptance	Final Acceptance (CON-501)	Contractor/Town	Chief	TSE	TSE	Digital
1-10 & 11	Final Audit Request for...(List Item)	Final Audit Request for "..."(List Item)	AUDITS	FINALS	N/A	TE3	Electronic
1-10 & 11	Final Audit Request	Final Audit Request	AUDITS	FINALS	TSE	ADE	Electronic
1-11	District’s Response to Headquarters’ Final Review			Chief	TE3	ADE/DE	Electronic
1-12	Prompt Payment 1, 2		Contractor	Admin. Asst.	N/A	DE	Electronic
1-12	Prompt Payment 3		Contractor	Admin. Asst.	N/A	Const. Div. Chief	Electronic
1-12	Prevailing Wage Referral Form	Prevailing Wage Discrepancy	Department of Labor	EEO Coordinator	TE3	TSE (Office)	Electronic
1-13	Utility – Contract Start	Start Relocation (with permit)	Utility	Util. Coord.	TSE	DE	Digital
1-13	Utility – Contract Start	Notice to Commence Operations	Railroad	Util. Coord.	TSE	DE	Digital
1-13	Utility – Change in Scope	Authorization of Change in Scope	Utility	Util. Coord.	TSE	DE	Digital
1-13	Utility – Final Audit Request	Final Audit Request – Utility	Audits	Finals	N/A	TE3	Electronic
1-13	Utility – Final	Final Audit Payment – State Reimbursement	Town	Util. Coord.	TSE	DE	Digital
1-13	Utility – Final	Final Audit Payment – State Reimbursement	Accts. Receivable	Util. Coord.	N/A	TE3	Electronic
1-13	Utility – Final	Final Audit Payment – Final Payment Invoice	Town	Util. Coord.	N/A	TE3	Electronic
1-13	Utility – Final Audit Payment	Final Audit Payment – Final Payment Invoice	Audits	Util. Coord.	N/A	TE3	Electronic
1-13	Utility/Railroad Force Account	Activate (Deactivate) Force Account	Utility	Util. Coord.	N/A	TE3	Electronic

Appendices

Construction Manual Standard Correspondence

<u>CM CHPT</u>	<u>Reference</u>	<u>Description of Subject</u>	<u>Addressee</u>	<u>Preparer</u>	<u>Reviewer</u>	<u>Signer/ Approver</u>	<u>Signature Type (Digital/Electronic)</u>
1-15	Insurance Claim	Insurance Claim	Contractor	Office	N/A	DE	Electronic
1-15	Insurance Claim	Insurance Claim	Claimant	Office	N/A	DE	Electronic
1-17	Consultant – Certification	Subconsultant Scope and DBE Approval	Negotiations	TE3	TSE	ADE	Electronic
1-17	Consultant – Contract Start	Notice to Proceed (Newington Letterhead)	Consultant	TE3	DE	Chief Engr.	Digital
1-17	Consultant – Fee Proposal	Fee Proposal	Negotiations	TE3	TSE	ADE	Electronic
1-17	Consultant Personnel Assignment	Personnel Assignment	Consultant	TE3	TSE	DE	Electronic
1-17	Consultant Personnel – Pay Increase	Pay Increases	Consultant	TE3	TSE	DE	Electronic
1-17	Consultant – Invoice Adjustment	Invoice Adjustments	Consultant	TE3	N/A	ADE/DE	Electronic
1-17	Consultant – Extra Work Claim	Extra Work Claim	DE	TE3	TSE	DE	Electronic
1-17	Consultant – Evaluations	Consultant Evaluation Letter	Const. Div. Chief	TE3	N/A	TSE	Electronic
1-17	Consultant – Insurance – Expiration	Certificate of Insurance	Consultant	Office	N/A	TE3	Electronic
1-17	Consultant – Final	Final Audit Request	Audits	TE3	TSE	ADE	Electronic
1-17	Consultant – Final	Final Audit Payment – State Reimbursement	Consultant	TE3	TSE	ADE	Electronic
1-17	Consultant – Final	Final Audit Payment - Final Payment Invoice	Consultant	TE3	TSE	ADE	Electronic
1-17	Consultant – Completion Date	Revision to Supplemental Agreement	DE	TE3	TSE	ADE	Digital
1-17	Consultant – Semi-Final Invoice	Request for Semi- Final Invoice	Consultant	TE3	TSE	DE	Electronic
1-17	Consultant – NTP		Consultant			DE	Digital
1-17	Consultant – Contract Completion		Consultant			DE	Digital
1-19	Insurance Expiration (Contractor)	Notice of Insurance Expiration	Contractor	Office Staff	N/A	Office TSE	Electronic
1-19	Contract Revision/ Performance Bond	Bond No. xxx (Revision, rider enclosed)	Contractor	Office	TSE/TE3	TSE (Office)	Electronic

Appendices

Construction Manual Standard Correspondence

<u>CM CHPT</u>	<u>Reference</u>	<u>Description of Subject</u>	<u>Addressee</u>	<u>Preparer</u>	<u>Reviewer</u>	<u>Signer/ Approver</u>	<u>Signature Type (Digital/Electronic)</u>
N/A	Test – 30 day (Begin) – Signals	Commencement of 30-Day Test Period	Contractor/ Town	Chief	N/A	TE3	Electronic
N/A	Test – 30 Day (End) – Signals	Completion of 30- Day Test Period	Contractor/ Town	TE3	TSE	ADE	Electronic

The use of handwritten signatures may be substituted when circumstances make the use of electronic or digital signatures difficult or impossible.

C-102 Standard List of Project Correspondence to be Maintained at the Field Office

Correspondence and other project information that is not part of the Volume Record-keeping system must be kept in an organized manner at the field office. Correspondence is sent through the District before it is forwarded to the field office. However, it is unacceptable for field type “speedy memorandums” from the Inspector to the Contractor to only be maintained at the field office.

The degree of the complexity of the system to keep the folders varies on the size of the project. Smaller projects in nature are usually kept by category of the contents of the folder. Larger projects that are required to use Primavera Contract Management formerly known as Primavera Expeditions use a more complex numerical sequential system. Usually the system is on an Excel spreadsheet and can be carried from project to project with minor alterations. The following are some examples of folders to be maintained on both smaller and larger projects. Files to be maintained in a Field Office (Smaller projects use the major files in bold and larger projects may want to use all of the files).

Table C-2 List of Project Correspondence

PROJECT DESCRIPTION - LOCATION - CITY		FAP #
CONTRACT	PROJECT	
FILE NO.		
0-99	GENERAL INFORMATION	
006	CONTRACTOR EVALUATIONS	
008	CONSTRUCTION CONTRACT (SPECS, REQUIREMENTS)	
009	PERMIT CORRESPONDENCE	
009.1	DEP	
009.2	ACOE	
009.3	USCG	
010	UTILITY AGREEMENT CORRESPONDENCE	
010.1	UI	
010.2	RWA	
010.3	P&WRR	
010.4		
010.5	CITY OF NEW HAVEN	
011	RIGHT OF WAY/DETOUR AGREEMENTS	
013	SURVEY CORRESPONDENCE	
015	AGREEMENTS W/CLIENT/CONSULTANT	
015.1	HEADQUARTERS EXAMINERS REPORT	
100	BID & AWARD DOCUMENTS	
108	NOTICE TO PROCEED	
200-299	CONSTRUCTION STARTUP	
201	PRECONSTRUCTION MEETING MINUTES	
202	ESSENTIAL PERSONNEL INFO/PHONE NUMBERS	
203	FIELD OFFICE (CHAPEL ST.)	
204	SUBCONTRACTOR CORRESPONDENCE	
204.1		
204.2		
205	LOCAL BUSINESSES, LANDOWNERS CORRESPONDENCE	

300-399	COMMUNICATIONS CONTROL
301	CDOT CORRESPONDENCE
301.1	FROM OTHERS TO CDOT
301.2	FROM CDOT TO CONTRACTOR/OTHERS
301.3	CDOT INTERNAL CORRESPONDENCE
301.4	FROM CONSULTANT TO DOT
301.5	FROM DOT TO CONSULTANT
301.6	FROM CONSULTANT TO CONTRACTOR
302	DESIGNER CORRESPONDENCE
302.1	TO DESIGNER
302.2	FROM DESIGNER
303	CONTRACTOR CORRESPONDENCE
303.1	FROM OTHERS TO CONTRACTOR
303.2	FROM CONTRACTOR TO CDOT AND CONSULTANT
303.3	FROM CONTRACTOR TO OTHERS
304	UTILITY CORRESPONDENCE
305	STATUTORY AUTHORITY CORRESPONDENCE
305.1	DEP
305.2	ACOE
305.3	FHWA
307	SUBCONSULTANT CORRESPONDENCE
307.1	PB AMERICAS
307.2	SUB-CONSULTANT
307.3	TRC
308	TELEPHONE CALL REPORTS
309	EMAILS
310	FIELD MEMORANDUMS
310.1	TO CONTRACTOR
310.2	FROM CONTRACTOR
310.3	OUTGOING FAXES
310.4	INCOMING FAXES
320 - 327	MEETING MINUTES
323	SCHEDULE MEETINGS
324	MISC. MEETING MINUTES
325	PROGRESS MEETING MINUTES
326	UTILITY MEETING MINUTES
327	DESIGN MEETING MINUTES
328	CONTRACTOR/SUBCONTRACTOR EQUIPMENT
329	CDOT PROCEDURES/ADVISORIES
330	INSURANCE RECORDS
330.1	CONTRACTOR
330.2	SUBCONTRACTOR
403	REQUEST FOR INFORMATION
403.1	RFI #1

403.2	RFI #2
404	AS-BUILT DRAWINGS
406	CONTRACT DWG CHANGES
407	SUBMITTALS
	DESIGN INQUIRIES (5000 SERIES - RFI'S FROM US ONLY
408	NOT CONTRACTOR)
500-599	SCHEDULE CORRESPONDENCE
501	INITIAL BASELINE SCHEDULE
502	PROJECT SCHEDULE UPDATES
503	TWO WEEK SCHEDULES
504	NIGHT/WEEKLY SCHEDULES
505	SCHEDULE CHANGES/TIME EXTENSIONS
600-699	COST CONTROL
600	RETAINAGE
601	PAYMENT ESTIMATES
602	PAYMENT ESTIMATE CORRESPONDENCE
603	UNIT PRICES
603.1	PAYMENT ISSUES
604	QUANTITY CORRESPONDENCE
605	MATERIAL STORED ON SITE
606	CONSTRUCTION COMMUNICATION EQUIPMENT
607	COST PLUS RECORDS
607.1	FINAL COST PLUS
608	MATERIAL RECEIPTS
609	TRAFFICMEN
609.1	TRAFFICMEN INVOICES
610	EXTRA WORK
610.1	REQUEST FOR PRICE
610.2	PRICE SUBMITTALS/PROPOSALS
610.3	PRICE ACCEPTANCE/DENIAL
611	CONSTRUCTION ORDER CORRESPONDENCE
612	VALUE ENGINEERING CHANGE PROPOSALS
613	ISSUES / DISPUTES
800	QUALITY CONTROL
807	REQUEST FOR CHANGE
807.1	RFC #1
820	TESTING CORRESPONDENCE/PROCEDURES
821	EARTHWORK TESTING
822	CONCRETE INFO
822.1	CONCRETE TESTING
822.2	CONCRETE TICKETS
823	HAZARDOUS MATERIALS
824	MISC. TESTING
825	SEDIMENTATION HANDLING

826	MATERIAL DISPOSAL
826.1	VS&G TICKETS
827	EXCAVATED MATERIAL TRANSFER TICKETS
828	STONE TICKETS
829	MATERIAL CERTIFICATES
830	CDOT TEST REPORTS
831	SUPERPAVE/ASPHALT INFO
832	ULTRASONIC TESTING INFO
843	ENVIRONMENTAL COMPLIANCE
844	WATER POLLUTION CONTROL
850	REUSE MATERIAL
860	NON-CONFORMANCE NOTICES
900-999	SAFETY & LOSS CONTROL
901	OWNERS SAFETY PLAN/CORRESPONDENCE
902	CONTRACTORS SAFETY PLAN/CORRESPONDENCE
903	HASP
904	SIGNAGE
905	TRAFFIC CONTROL/SIGNALIZATION
906	SITE SECURITY
913	ACCIDENT/INCIDENT REPORTS
930	STOP WORK NOTICES
1000	PUBLIC RELATIONS/NOTIFICATIONS
1001	PARTNERING INFO
1002	CONTACTS W/PUBLIC, RIDEWORCS
1003	NEWS MEDIA
1004	COMPLAINTS
1100	CONTRACT CLOSEOUT & COMPLETION
1101	WARRANTIES/GUARANTEES
1105	RELIEF OF RESPONSIBILITIES
1106	PUNCHLISTS
1107	SEMIFINAL INSPECTIONS
1120	MISC. CLOSEOUT DOCUMENTATION
1200	PAYROLL INFORMATION
1205	CONTRACTOR PAYROLLS
1206	
1207	SUBCONTRACTOR PAYROLLS
1207.1	SUBCONTRACTOR
1207.2	SUBCONTRACTOR
1207.3	SUBCONTRACTOR
1208	EEO / AA INFO
1209	LABOR WAGE CHECK INFO
1210	DBE INFO
1211	SUBCONTRACTOR APPROVALS
1215	APPRENTICE/TRAINEE DOCUMENTS
1300	ISSUE FILE

Appendices

Appendix D - Approved Forms and Inspection Checklists

Approved Forms and Inspection Checklists can be found in ProjectWise.

[\(Documents - 04.1 - Construction Libraries - 04.200 - Approved Forms and Inspection Checklists\)](#)

Table of Contents

Rev.

Chapter 1 - Environmental Protection

2-100	General.....	2-1.1	
2-101	Permits, Water Resource and Natural Resource Coordination	2-1.1	
2-101A	Department of Environmental Protection (DEEP).....	2-1.1	Jan 2020
2-101B	Army Corps of Engineers (ACOE).....	2-1.2	
2-101C	United State Coast Guard (USCG)	2-1.3	
2-101D	Department of Transportation.....	2-1.3	
2-101E	Water Resources	2-1.3	
2-101F	Natural Resources	2-1.3	
2-102	Pollution Control Regulations.....	2-1.3	
2-102A	Air Pollution	2-1.4	
2-102B	Noise Pollution	2-1.4	
2-102C	Water Pollution Control.....	2-1.4	
2-102D	Turbidity Monitoring	2-1.4	Jan 2020
2-103	Specifications.....	2-1.5	Jan 2020
2-103A	Response to Environmental Deficiencies.....	2-1.5	
2-104	Duties and Responsibilities.....	2-1.6	
2-104A	Qualified Inspection Personnel	2-1.6	
2-104B	Inspector.....	2-1.6	
2-104C	District Environmental Coordinator.....	2-1.6	
2-104D	District Office	2-1.7	
2-104E	Office of Environmental Planning	2-1.7	
2-104F	Contractor	2-1.7	
2-105	Permit Process.....	2-1.8	
2-105A	Department of Environmental Protection (DEEP).....	2-1.8	
2-105B	Army Corps of Engineers (ACOE).....	2-1.8	
2-106	Review of Contract Documents	2-1.8	
2-106A	Preconstruction Meeting	2-1.9	
2-106B	Site Preparation.....	2-1.10	
2-107	Permit Modifications.....	2-1.10	
2-108	Procedure for Requesting Technical Revisions, Notifications or de Minimis changes to DEEP or ACOE Permits	2-1.10	Jan 2020
2-108A	Technical Plan Revisions or Notification	2-1.11	Jan 2020

2-108B	de Minimis Change	2-1.11	
2-109	Controlled or Hazardous Materials	2-1.12	
2-109A	Known Materials on Site	2-1.12	
2-109B	Unknown Materials Found on Site	2-1.12	
2-109C	Contractor Spills	2-1.13	
2-109D	Emergency Response Procedure	2-1.13	Jan 2020
2-110	Structure Painting Debris	2-1.14	
2-110A	Containment and Collection of Surface Preparation Debris	2-1.14	
2-110B	Lead Compliance	2-1.14	
2-110C	Disposal of Hazardous or Non-Hazardous Debris	2-1.14	
2-110D	Non-Hazardous Debris	2-1.15	
2-110E	Hazardous Debris	2-1.15	
2-110F	Miscellaneous Construction Details (Clean Waste)	2-1.15	
2-111	Sedimentation and Erosion Controls	2-1.15	
2-111A	Handling Water	2-1.16	
2-111B	Dewatering	2-1.16	
2-111C	Slope Stabilization	2-1.16	
2-112	Water Pollution Control	2-1.17	
2-112A	Off-Site Locations	2-1.17	
2-112B	Storage of Materials and Equipment	2-1.17	
2-113	Contractor Non-Compliance	2-1.17	
2-113A	Department Authority	2-1.17	
2-113B	24-Hour Rule	2-1.18	
2-114	Reports and Recordkeeping	2-1.19	
2-114A	Environmental Checklist / Construction Site Environmental Inspection Report	2-1.19	
2-114B	Recycling Report for Construction Projects	2-1.20	
2-114C	Recordkeeping	2-1.20	
2-115	Procedure Relating to Emergency Declaration Projects	2-1.20	Jan 2020

Chapter 2 - Construction Surveys - Revisions in progress Jan 2020

2-201	Survey Parties	2-2.1
2-201A	Responsibilities and Duties of Survey Parties on Construction Projects	2-2.1
2-201B	Responsibilities and Duties of Chief of Party	2-2.1

2-201C	Assignment of Survey Parties	2-2.2
2-202	Survey Equipment.....	2-2.3
2-202A	Assignment of Field Party Equipment	2-2.3
2-202B	Use of Equipment	2-2.3
2-202C	Transporting Equipment	2-2.3
2-202D	Damage to Equipment.....	2-2.3
2-203	Safety and Traffic Control	2-2.3
2-204	Note Keeping	2-2.4
2-204A	Standard Note Keeping	2-2.4
2-204B	Care of Notebooks	2-2.4
2-204C	Survey Notes.....	2-2.4
2-204D	Notes for Bench Levels.....	2-2.5
2-204E	Cross Section Note Guidelines	2-2.6
2-204F	Cross Section Notes (Levels and Rods)	2-2.7
2-204G	Notes on Bridge Staking	2-2.7
2-204H	Notes for Construction Stakes	2-2.7
2-205	Computations	2-2.7
2-205A	Completeness of Computations	2-2.7
2-205B	Revisions to Computations	2-2.7
2-206	Staking	2-2.8
2-206A	Staking Centerline.....	2-2.8
2-207	Cross Sections	2-2.12
2-207A	Earthwork.....	2-2.12
2-207B	Rock Excavation	2-2.12
2-207C	Unsuitable Material.....	2-2.12
2-207D	Borrow Banks	2-2.13
2-207E	Stakes for Concrete and Other High Type Pavements.....	2-2.13
2-207F	Staking Bridge Structures	2-2.13
2-207G	Staking Special Structures	2-2.14
2-208	Replacing Stakes.....	2-2.14
2-209	Measurements for Monthly Estimates	2-2.14
2-210	Final Survey.....	2-2.15

Chapter 3 - Excavation and Embankment - Revisions in progress Jan 2020

2-300	General.....	2-3.1
2-300A	Introduction.....	2-3.1
2-300B	Definitions	2-3.1
2-301	Setting Slope Stakes.....	2-3.1
2-302	Clearing and Grubbing.....	2-3.2
2-302A	Description.....	2-3.2
2-302B	Preliminary Activities	2-3.2
2-302C	Tree Removal and Protection.....	2-3.3
2-302D	Disposing of Materials	2-3.4
2-302E	Disposal Outside the Highway Limits	2-3.4
2-302F	Disposal Inside the Highway Limits	2-3.4
2-302G	Areas Outside Roadway Limits But Within Highway Taking Lines	2-3.4
2-303	Survey Markers and Monuments	2-3.5
2-304	Excavation and Embankment.....	2-3.5
2-304A	Definitions	2-3.5
2-304B	Earth Excavation.....	2-3.5
2-304C	Excavation Procedure	2-3.6
2-305	Rock Excavation	2-3.6
2-305A	Determining the Quantity To Be Removed	2-3.6
2-305B	Blasting Safety Meeting.....	2-3.7
2-305C	Presplitting Rock Slopes	2-3.7
2-306	Blasting Regulations and Good Practices	2-3.8
2-306A	Regulations	2-3.8
2-306B	Transport and Storage.....	2-3.8
2-306C	Warnings.....	2-3.8
2-306D	Special Precautions	2-3.9
2-306E	Normal Operations.....	2-3.10
2-306F	Recordkeeping	2-3.10
2-306G	Operations.....	2-3.10
2-306H	Payment.....	2-3.11
2-307	Surplus and Unsuitable Material.....	2-3.11
2-308	Surplus Material.....	2-3.11
2-309	Unsuitable Material.....	2-3.12
2-309A	General.....	2-3.12

2-309B	Top Soil.....	2-3.12
2-309C	Use or Disposal of Material	2-3.13
2-310	Salvageable Material.....	2-3.14
2-311	State’s Property	2-3.14
2-312	Contractor’s Property.....	2-3.14
2-313	Use of Reclaimed Waste Materials on Construction Projects.....	2-3.14
2-314	Conditions Requiring Corrective Work	2-3.15
2-315	Embankment Building	2-3.15
2-315A	General.....	2-3.15
2-315B	Borrow	2-3.16
2-315C	Corrections.....	2-3.16
2-316	Monthly Pay Quantities	2-3.16
2-317	Final Pay Quantities.....	2-3.17
2-318	Winter Embankment Operations.....	2-3.18
2-319	Embankment Density.....	2-3.18
2-319A	Field Sampling for Proctor Determinations	2-3.18
2-319B	Field Density Test Equipment.....	2-3.19
2-319C	Field Density Test Procedures and Steps.....	2-3.19
2-320	Water Pollution	2-3.20
2-320A	Sedimentation Control Plan	2-3.20
2-320B	Responsibilities	2-3.20
2-320C	Operations.....	2-3.20
2-321	Call Before You Dig	2-3.22
2-321A	Utility Warning Tapes.....	2-3.22
2-321B	Reporting	2-3.23

Chapter 4 - Drainage - Revisions in progress Jan 2020

2-400	General.....	2-4.1
2-401	Purpose.....	2-4.1
2-402	Outlets.....	2-4.2
2-403	Natural Water Course	2-4.2
2-404	Drainage Right-of-Way	2-4.2
2-405	Right-to-Drain.....	2-4.2
2-406	Adverse Rights.....	2-4.2
2-407	Agreements	2-4.3

2-408	Runoff Design.....	2-4.3
2-409	Trench Excavation	2-4.3
2-409A	General.....	2-4.3
2-409B	Rock Excavation	2-4.4
2-409C	Backfilling	2-4.4
2-410	Foundations.....	2-4.4
2-411	Culverts.....	2-4.4
2-412	Types of Culverts.....	2-4.5
2-412A	Corrugated Metal Pipe	2-4.5
2-412B	Plate Pipes and Arches.....	2-4.6
2-412C	Concrete Pipe.....	2-4.6
2-413	Pipe Selection.....	2-4.6
2-413A	General Guidelines.....	2-4.6
2-413B	Available Metal Pipe.....	2-4.7
2-413C	Concrete Pipe Strength	2-4.7
2-413D	Loading	2-4.7
2-414	Materials Inspection.....	2-4.7
2-414A	Corrugated Metal Pipe	2-4.8
2-414B	Concrete Pipe.....	2-4.8
2-415	Culvert and Endwall Layout	2-4.10
2-415A	General Method	2-4.10
2-415B	Field Method.....	2-4.10
2-416	Trench Excavation	2-4.12
2-417	Foundations.....	2-4.12
2-418	Culvert Installation.....	2-4.14
2-418A	Corrugated Metal Pipe	2-4.15
2-418B	Plate Pipe and Arches	2-4.15
2-418C	Concrete Pipe.....	2-4.15
2-419	Backfilling	2-4.16
2-420	Drainage Structures.....	2-4.16
2-420A	Materials Inspection of Precast Units	2-4.16
2-420B	Culvert End Treatment.....	2-4.17
2-420B.1	Endwalls.....	2-4.17
2-420B.2	End Sections	2-4.17
2-420B.3	Endwall Improvements	2-4.17
2-420C	Box Culverts	2-4.18

2-420D	Catch Basins and Drop Inlets.....	2-4.18
2-420D.1	New Construction	2-4.18
2-420D.2	Resetting Catch Basins.....	2-4.19
2-420E	Manholes.....	2-4.21
2-421	Underdrains.....	2-4.21
2-421A	Subsurface Drainage Systems.....	2-4.21
2-421B	Excavation and Installation.....	2-4.23
2-421C	Backfilling	2-4.23
2-422	Ditches and Channels.....	2-4.24

Chapter 5 - Base Courses

2-501	Subgrade	2-5.1	
2-501A	General.....	2-5.1	
2-501B	Subgrade Construction Methods.....	2-5.1	Jan 2020
2-502	Subbase	2-5.1	
2-502A	General.....	2-5.1	
2-502B	Subbase Construction Methods.....	2-5.2	Jan 2020
2-503	Base Courses.....	2-5.3	Jan 2020
2-504	Processed Aggregate Base	2-5.4	Jan 2020
2-504A	General.....	2-5.4	Jan 2020
2-504B	Processed Aggregate Base Construction Methods.....	2-5.4	Jan 2020
2-505	HMA S1.0.....	2-5.5	Jan 2020
2-505A	Pavetrack.....	2-5.5	Jan 2020

Chapter 6 - Bituminous Pavements - Revisions in progress..... Jan 2020

2-601	Bituminous (HMA) Pavements.....	2-6.1
2-601A	General.....	2-6.1
2-602	Bituminous Concrete Mixes and Applications	2-6.1
2-602A	Dense Graded Mixes.....	2-6.1
2-602B	Gap Graded Mixes	2-6.2
2-603	Contract Specifications	2-6.3
2-604	Contract Plans	2-6.3
2-605	Production Responsibility	2-6.3
2-606	Inspection Responsibilities	2-6.4

2-606A	Materials Testing Laboratory.....	2-6.4
2-606B	District Responsibilities	2-6.4
2-606C	Preliminary Inspection and Approval of Plant.....	2-6.4
2-606D	Pavetrack.....	2-6.4
2-607	Inspection Prior to Paving.....	2-6.5
2-607A	Paving Equipment	2-6.5
2-607B	Paving Machines.....	2-6.5
2-607C	Rollers	2-6.8
2-607D	Material Transfer Vehicle (MTV).....	2-6.9
2-607E	Lighting.....	2-6.10
2-608	Base Preparation	2-6.10
2-609	Utilities.....	2-6.10
2-610	Prepaving Meeting	2-6.11
2-611	Test Section.....	2-6.11
2-612	Traffic Control	2-6.11
2-613	Inspection During Paving	2-6.11
2-613A	The Day Before.....	2-6.11
2-613B	Transportation of Mixture.....	2-6.11
2-613C	Paving Inspection.....	2-6.12
2-614	Tack Coat.....	2-6.13
2-615	Mechanical Spreading.....	2-6.14
2-615A	Screed Unit	2-6.14
2-615B	Angle of Attack.....	2-6.16
2-615C	Head of Material	2-6.16
2-615D	Paving Speed.....	2-6.17
2-615E	Other Factors.....	2-6.18
2-616	Hand Spreading.....	2-6.18
2-617	Delays or Shutdowns	2-6.19
2-618	Thickness and Tonnage Control	2-6.19
2-619	Determining Planned Rate of Spread.....	2-6.20
2-620	Depth and Yield Checks	2-6.21
2-620A	Depth Checks.....	2-6.21
2-620B	Yield Checks.....	2-6.21
2-620C	Inspector Responsibility.....	2-6.21
2-620D	Stationing.....	2-6.21
2-620E	Computing Actual Rates of Spread.....	2-6.22

2-621	Compaction	2-6.26
2-621A	Rolling	2-6.26
2-621B	Initial or Breakdown Rolling	2-6.27
2-621C	Intermediate Rolling	2-6.28
2-621D	Finish Rolling	2-6.28
2-622	Compaction Testing	2-6.28
2-622A	Quality Control (QC) Testing	2-6.28
2-622B	Quality Assurance (QA) Testing.....	2-6.29
2-623	Transverse Joints.....	2-6.29
2-624	Permanent Transitions	2-6.29
2-625	Permanent Transitions at Structures	2-6.30
2-626	Temporary Transitions	2-6.30
2-627	Longitudinal Joints.....	2-6.33
2-627A	Notched Wedge Joint.....	2-6.33
2-628	Longitudinal Joint Construction Methods.....	2-6.34
2-629	Surface Tolerance	2-6.34
2-630	Pavement Smoothness (Rideability) Adjustments	2-6.35
2-631	Semi-final and Final Pavement Inspections	2-6.35
2-631A	Opening to Traffic	2-6.35
2-632	Records	2-6.35
2-362A	Form MAT-100.....	2-6.35
2-632B	Weekly HMA Production Report	2-6.36
2-632C	Inspectors' Reports	2-6.36
2-632D	Delivery Tickets.....	2-6.36
2-633	Test Frequencies	2-6.37
2-634	District and Headquarters Monitoring	2-6.37
2-635	Legal Load Limits and Oversize/Overweight Permit Regulations	2-6.37
2-636	Bituminous Concrete Adjustment Procedures	2-6.38
2-637	Pavement Rehabilitation	2-6.38
2-637A	General.....	2-6.38
2-637B	Inspection of Work Site Before Work Commences.....	2-6.38
2-637C	Inspection of Bituminous Concrete Prior to Overlay.....	2-6.39
2-637D	Repairs to Existing Bituminous Pavement.....	2-6.39
2-637D.1	Joint/Crack Sealing and Filling.....	2-6.39
2-637D.2	Alligatored Cracking Pavement Repairs.....	2-6.39
2-637D.3	Pothole Repairs	2-6.39

2-637D.4	Leveling	2-6.39
2-637D.5	Milling (Cold Plane Pavement Removal)	2-6.42
2-637E	Repairs to Existing Concrete Pavements	2-6.43
2-637E.1	Partial Depth Patch Repair	2-6.43
2-637E.1a	Preparations	2-6.43
2-637E.1b	Tacking	2-6.44
2-637E.1c	Repairs	2-6.44
2-637E.2	Full-Depth Concrete Pavement Replacement	2-6.44
2-637E.2a	Subbase and Subgrade Preparation	2-6.44
2-637F	Bituminous Concrete Overlay	2-6.44
2-638	Bituminous Lip Curbing	2-6.45
2-638A	General	2-6.45
2-638B	Machine Construction	2-6.45
2-638C	Hand Construction	2-6.46
2-638D	Bituminous Concrete Driveway Aprons	2-6.46
2-638E	Precautions	2-6.46

Chapter 7 - Concrete Pavements - Revisions in progress..... Jan 2020

2-701	New Pavement	2-7.1
2-702	Specifications and Plans	2-7.1
2-702A	Specifications	2-7.1
2-702B	Plans	2-7.1
2-703	Inspection Team	2-7.2
2-704	Mix Request	2-7.2
2-705	Materials Control	2-7.2
2-706	Batching and Mixing Equipment	2-7.4
2-707	Plant Personnel	2-7.4
2-708	Truck Mixers	2-7.4
2-709	Preliminary Checks	2-7.4
2-710	Finishing Labor	2-7.5
2-711	Placing and Finishing Tools	2-7.5
2-712	Testing Equipment	2-7.5
2-713	Cold Weather Provisions	2-7.6
2-714	Subgrade	2-7.6
2-715	Subbase	2-7.6

2-716	Side Forms	2-7.7
2-716A	Reference Line	2-7.7
2-716B	Form Condition	2-7.7
2-716C	Bracing Pins	2-7.7
2-716D	Wooden Forms	2-7.7
2-716E	Sharp Curves	2-7.8
2-716F	Line and Grade	2-7.8
2-716G	Form Placement	2-7.8
2-716H	Longitudinal Joint Key	2-7.9
2-717	String Lines	2-7.9
2-717A	Slip-Form String Lines	2-7.9
2-717B	Normal String-Line Setting	2-7.10
2-717C	String-Line Repairs	2-7.11
2-718	Fine Grade	2-7.12
2-719	Joints	2-7.12
2-719A	Transverse	2-7.12
2-719B	Longitudinal	2-7.13
2-719C	Locating Transverse Joints	2-7.14
2-719D	Transverse Joint Construction	2-7.14
2-719E	Load Transfer Assemblies	2-7.16
2-719F	Dummy Joints	2-7.16
2-719G	Bulkheads	2-7.17
2-719H	Construction Joints	2-7.17
2-719I	Longitudinal Joint Construction	2-7.17
2-720	Paving Trains	2-7.18
2-720A	Side-Form Paving	2-7.18
2-720A.1	Initial Strike-off Spreader	2-7.19
2-720A.2	Transverse Finishing Machine	2-7.19
2-720B	Slip-Form Paving	2-7.19
2-720B.1	Spreader	2-7.19
2-720B.2	Paver	2-7.19
2-720C	Finishing Machines	2-7.20
2-720C.1	Longitudinal Float	2-7.20
2-720C.2	Flexplane Float	2-7.20
2-720C.3	Chevron Float	2-7.21
2-720C.4	Tube Float	2-7.21

2-720D	Tining Machine.....	2-7.21
2-721	Final Preparations for Placement of Concrete	2-7.21
2-722	Inspection Team.....	2-7.21
2-722A	Concrete Inspector	2-7.21
2-722B	Paving Inspector	2-7.22
2-722C	Finishing Inspector	2-7.22
2-723	Concrete Mix	2-7.22
2-723A	Mix Adjustments.....	2-7.22
2-723B	Consistency	2-7.23
2-723C	Slump Test	2-7.23
2-723D	Test Cylinders	2-7.23
2-724	Concrete Placement – Side-Form Paving	2-7.24
2-724A	Side-Form Placement of Lower Course.....	2-7.24
2-724B	Spreading	2-7.24
2-724C	Consolidation	2-7.25
2-724D	Placing Concrete Adjacent to Transverse Joints.....	2-7.25
2-724E	Reinforcement.....	2-7.25
2-724F	Side-Form Placement of Top Course.....	2-7.26
2-724G	Paving Adjacent Lanes	2-7.26
2-724G.1	Equipment Operation	2-7.26
2-724G.2	Longitudinal Joint	2-7.27
2-724H	Construction Joint	2-7.27
2-724I	Clean up	2-7.27
2-724J	Cold Weather	2-7.27
2-725	Concrete Placement – Slip-Form Paving	2-7.28
2-725A	Slip-Form Spreader Operation	2-7.28
2-725B	Slip-Form Paver Operations	2-7.28
2-725C	General Inspection	2-7.28
2-725D	Paver Speed.....	2-7.29
2-725E	Paver Movement	2-7.29
2-725F	Base Irregularities	2-7.29
2-725G	Mix Consistency and Quality.....	2-7.29
2-725H	Edge Slumping.....	2-7.30
2-725I	Consolidation	2-7.30
2-726	Finishing Pavement.....	2-7.30
2-726A	Hand Finishing.....	2-7.30

2-726B	Finishing Machine	2-7.30
2-726C	Longitudinal Floats	2-7.31
2-726C.1	The Longitudinal Float	2-7.31
2-726C.2	The Flexplane Float	2-7.31
2-726C.3	The Chevron Float	2-7.32
2-726C.4	The Tube Float	2-7.32
2-726D	Luting	2-7.32
2-726E	Joints	2-7.33
2-726E.1	Expansion Joints	2-7.33
2-726E.2	Contraction Joints	2-7.34
2-726E.3	Transverse Joints.....	2-7.34
2-726F	Straightedging	2-7.35
2-726G	Tining.....	2-7.35
2-726H	Edging.....	2-7.35
2-727	Curing and Protection	2-7.36
2-727A	Moist Curing	2-7.36
2-727B	Curing Compound.....	2-7.37
2-727C	Polyethylene Cover Sheet Curing	2-7.37
2-728	Temporary Crossovers	2-7.38
2-729	Removing Forms.....	2-7.38
2-730	Sawing Longitudinal Joints.....	2-7.38
2-731	Sealing Joints	2-7.39
2-732	Daily Reports and Tests	2-7.39
2-733	Air Content	2-7.43
2-733A	Pressure Air Meter	2-7.43
2-733B	Chace Air Indicator.....	2-7.44
2-734	Pavement Cores	2-7.45
2-735	Opening the Pavement to Traffic	2-7.45
2-736	Full-Depth Concrete Pavement Replacement	2-7.45
2-736A	Concrete Removal.....	2-7.45
2-736B	Sawing	2-7.45
2-736C	Removal	2-7.46
2-736D	Existing Bituminous Patches	2-7.46
2-736E	Subbase	2-7.46
2-736F	Load Transfer.....	2-7.46
2-736G	Forms	2-7.47

2-736H	Reinforcement.....	2-7.47
2-736I	Placement and Finishing	2-7.47
2-736J	Consolidation	2-7.47
2-736K	Strike Off and Finishing.....	2-7.48
2-736L	Surface Tolerances.....	2-7.48
2-736M	Joint Sealing.....	2-7.48
2-736N	Curing	2-7.48
2-736O	Testing	2-7.48
2-736P	Opening to Traffic	2-7.48

Chapter 8 - Structures - Revisions in progress Jan 2020

2-801	New Construction	2-8.1
2-801A	Storage/Staging of Materials and Equipment on Structures	2-8.1
2-801B	Load Restrictions	2-8.1
2-802	Chief Inspector’s Duties	2-8.2
2-803	Changes.....	2-8.3
2-804	Shop Drawings.....	2-8.3
2-805	Manufacturer’s Supervision.....	2-8.3
2-806	Cofferdams and Underwater Concrete.....	2-8.4
2-807	Foundation Seals.....	2-8.4
2-808	Pumping	2-8.5
2-809	Removal of Cofferdams or Cribs	2-8.5
2-810	Stability of Foundations	2-8.6
2-811	Excavation	2-8.6
2-812	Tying New Concrete to Existing Concrete	2-8.6
2-813	Foundations.....	2-8.7
2-813A	Spread Footings	2-8.7
2-813B	Foundations Seated in Rock.....	2-8.8
2-813C	Pile Supported Foundations	2-8.8
2-813C.1	Load Test	2-8.10
2-813C.2	Driving Plan.....	2-8.10
2-813C.3	Equipment	2-8.10
2-813C.4	Driving	2-8.11
2-813C.5	Tolerances	2-8.12
2-813C.6	Unacceptable Piles	2-8.12

2-813C.7	Reporting	2-8.12
2-814	Formwork.....	2-8.12
2-815	Reinforcement.....	2-8.13
2-815A	Plan Dimensions	2-8.13
2-815B	Cutting and Bending	2-8.13
2-815C	Storage	2-8.13
2-815D	Installation	2-8.13
2-815E	Splicing	2-8.14
2-815F	Epoxy Coating for Bars	2-8.14
2-816	Concrete	2-8.15
2-816A	Concrete Mix	2-8.15
2-816B	Sampling and Quality Control	2-8.15
2-816B.1	Sampling	2-8.15
2-816B.2	Testing	2-8.16
2-816C	Placement.....	2-8.16
2-816D	Construction Joints.....	2-8.17
2-816E	Placing Concrete in Cold Weather.....	2-8.18
2-816F	Curing	2-8.18
2-816G	Finishing Concrete Surfaces	2-8.19
2-816G.1	Horizontal surfaces	2-8.20
2-816G.2	Sidewalks and Safety Curb	2-8.20
2-816G.3	Culvert Slabs.....	2-8.20
2-817	Superstructures.....	2-8.20
2-817A	Steel Bridges	2-8.20
2-817B	Box Girders.....	2-8.21
2-817C	Temporary Bridges	2-8.21
2-817D	Prestressed Bridges	2-8.21
2-817D.1	Strength.....	2-8.22
2-817D.2	Camber.....	2-8.22
2-817D.3	Bearing Areas	2-8.22
2-817D.4	Unacceptable Units	2-8.22
2-817E	Anchor Bolts and Bearings	2-8.22
2-817F	Elastomeric Bearing Pads	2-8.23
2-817F.1	Materials	2-8.24
2-817F.2	Bearing Areas	2-8.24
2-817F.3	Installation	2-8.24

2-817F.4	Nonconforming Work.....	2-8.25
2-817G	Pot Bearings or Disc Bearings	2-8.25
2-817H	Expansion Dams	2-8.26
2-817I	Steel Erection.....	2-8.28
2-817J	Shear Connectors	2-8.28
2-817K	Welding.....	2-8.28
2-817K.1	Welder Qualifications	2-8.28
2-817K.2	Inspection.....	2-8.28
2-817K.3	Weld Quality.....	2-8.29
2-817K.4	Defective Welds.....	2-8.29
2-817L	Bolted Connections.....	2-8.30
2-817M	Utility or Conduit Installation.....	2-8.30
2-817N	Bridge Deck Procedures	2-8.30
2-817N.1	Grades, Formwork and Screed Rails.....	2-8.30
2-817N.2	Placing Concrete	2-8.31
2-817N.3	Finishing	2-8.32
2-817O	Joints	2-8.33
2-817O.1	Sealants	2-8.33
2-817O.2	Expansion Joint Material	2-8.33
2-817O.3	Systems and Devices.....	2-8.34
2-817P	Protective Surface Treatment Compounds.....	2-8.35
2-818	Bridge Rehabilitation	2-8.35
2-818A	General.....	2-8.35
2-818B	Utilities.....	2-8.36
2-818C	Bridge Deck Repair.....	2-8.36
2-818C.1	Removal of Bituminous Wearing Surface	2-8.37
2-818C.2	Location and Marking of Deteriorated Areas	2-8.37
2-818C.3	Removal of Deteriorated Concrete	2-8.38
2-818C.3a	Protective shields	2-8.38
2-818C.3b	Removal by Pneumatic Hammer.....	2-8.38
2-818C.3c	Removal by Hydro-demolition	2-8.39
2-818C.4	Patching	2-8.40
2-818C.4a	Preparations	2-8.40
2-818C.4b	Spreading and Finishing	2-8.41
2-818C.4c	Testing	2-8.41
2-818C.4d	Unacceptable Work.....	2-8.41

2-818C.4e	Opening To Traffic	2-8.41
2-818C.5	Waterproofing Membrane.....	2-8.41
2-818C.6	Placement of Bituminous Concrete Wearing Surface.....	2-8.42
2-818C.7	Bridge Deck Joints.....	2-8.42
2-818D	Structural Steel Inspection	2-8.42
2-818E	Jacking	2-8.43
2-818E.1	Jacks and Beams	2-8.43
2-818E.2	Welding and Repairs.....	2-8.43
2-818E.3	Operations.....	2-8.43
2-818F	Repair to Cover Plate Welds.....	2-8.44
2-818G	Inspection of Structural Steel Cross Section.....	2-8.44
2-818H	Heat Straightening Structural Members.....	2-8.45
2-818I	Removal of Existing Bridge Decks.....	2-8.45
2-818I.1	Protective Shields.....	2-8.45
2-818I.2	Operations.....	2-8.45
2-818J	Substructure Repairs	2-8.46
2-818K	Deteriorated Concrete Removal.....	2-8.46
2-818L	Repair Materials.....	2-8.47
2-818M	General Repair Requirements	2-8.47
2-818N	Shotcrete	2-8.47
2-818N.1	Equipment.....	2-8.47
2-818N.2	Preparatory Work.....	2-8.47
2-818N.3	Application.....	2-8.48
2-818O	Copolymer Cementitious Mortar	2-8.49
2-818P	Crack Repair by Epoxy Injection.....	2-8.49
2-819	Painting	2-8.49
2-819A	Preconstruction Requirements	2-8.50
2-819A.1	Debris and Material Storage	2-8.50
2-819A.2	Containment System Plan	2-8.50
2-819A.3	Containment Meeting.....	2-8.50
2-819B	Equipment.....	2-8.51
2-819C	Containment Enclosures	2-8.52
2-819D	Air Pressure in Containment Enclosures	2-8.52
2-819E	Surface Preparation.....	2-8.53
2-819F	Waste Disposal	2-8.54
2-819G	Coatings Inspection.....	2-8.54

2-819H	Materials	2-8.54
2-819I	Weather	2-8.54
2-819J	General Requirements	2-8.55
2-819K	Coating New Steel	2-8.55
2-819L	Coating Existing Steel.....	2-8.55
2-819M	Defective Work.....	2-8.56
2-819N	Stenciling	2-8.56
2-819O	Paint Storage	2-8.56
2-819P	Health and Safety	2-8.56
2-819Q	Reporting	2-8.57

Chapter 9 - Construction Traffic - Revisions in progress Jan 2020

2-901	General.....	2-9.1
2-902	Public Relations	2-9.1
2-902A	Press Releases	2-9.1
2-903	Highway and Underbridge Illumination	2-9.1
2-904	Maintenance and Protection of Traffic	2-9.2
2-905	General.....	2-9.2
2-906	Payment.....	2-9.3
2-907	Contractor Nonperformance	2-9.3
2-908	Public Safety	2-9.3
2-909	Potholes.....	2-9.4
2-910	Roadway Trenches.....	2-9.4
2-911	Low Bridge Clearance	2-9.4
2-912	Storage of Equipment and Material	2-9.4
2-913	Removal and Reinstallation of Rail Systems	2-9.6
2-914	Limitation of Operations.....	2-9.6
2-914A	Requests for Changes.....	2-9.6
2-914B	Expressway Projects	2-9.9
2-914C	Inspection.....	2-9.9
2-914D	Liquidated Damages	2-9.9
2-915	Speed Limits	2-9.10
2-916	Business Access	2-9.10
2-917	Traffic Control Patterns	2-9.11
2-917A	Temporary Patterns	2-9.12

2-917B	Permanent Patterns.....	2-9.13
2-917C	Detours.....	2-9.13
2-917D	Night Patterns	2-9.13
2-917E	Adjustments	2-9.13
2-918	Tapers.....	2-914
2-919	Buffer Space	2-914
2-920	Sign Placement.....	2-9.14
2-921	Inspection Responsibilities	2-9.15
2-921A	General Inspection	2-9.15
2-921B	Traffic Flow	2-9.16
2-921C	Lane Closures	2-9.16
2-922	Detours.....	2-9.17
2-922A	Detour of a State Highway to a Town Road	2-9.17
2-922B	Detour of a State Highway to Another State Highway	2-9.17
2-922C	Detour of a Town Road to Another Town Road.....	2-9.17
2-922D	Temporary Detours	2-9.18
2-922E	Detour Operations.....	2-9.18
2-923	Construction Signs.....	2-9.18
2-923A	Signs.....	2-9.18
2-923B	Ordering.....	2-9.19
2-923C	Placement.....	2-9.19
2-923D	16-Series Signs	2-9.19
2-923E	Inspection.....	2-9.20
2-924	Barricade Warning Lights.....	2-9.20
2-925	Extended Shutdowns.....	2-9.20
2-926	Changeable Message Signs.....	2-9.21
2-926A	Portable Signs	2-9.21
2-926B	Permanent Signs.....	2-9.22
2-927	Arrow Boards.....	2-9.22
2-928	Channelizing Devices	2-9.22
2-928A	Barricades	2-9.22
2-928B	Temporary Precast Concrete Barrier Curb.....	2-9.22
2-928C	Installation	2-9.23
2-928D	Taper Length.....	2-9.23
2-928E	Delineation.....	2-9.24
2-928F	Attachment.....	2-9.24

2-928G	End Treatments	2-9.25
2-928H	Component Inspection for TPCBC	2-9.25
2-928I	Payment for TPCBC	2-9.25
2-929	Impact Attenuation Modules (Sand Barrels)	2-9.26
2-930	42 Inch Traffic Cones	2-9.27
2-931	Traffic Drums.....	2-9.27
2-932	Pavement Markings	2-9.28
2-932A	Painted Markings	2-9.28
2-932B	Temporary Plastic Markings.....	2-9.29
2-932C	Marking Removal	2-9.29
2-933	Portable Impact Attenuator Systems (Crash Trucks)	2-9.29
2-933A	Use	2-9.29
2-933B	Inspection.....	2-9.30
2-934	Trafficperson.....	2-9.30
2-934A	General.....	2-9.30
2-934B	State Police Officers	2-9.31
2-934C	Town or City Police Officers or Uniformed Trafficpersons	2-9.31
2-934D	Prior Approval	2-9.31
2-934E	Work Control	2-9.31
2-934F	Operations.....	2-9.32
2-934G	Documentation	2-9.32
2-934H	Payment.....	2-9.33
2-935	Traffic Control During Construction Operations.....	2-9.33
2-935A	General.....	2-9.33
2-935B	Traffic Control Patterns	2-9.33
2-935C	Placement of Signs.....	2-9.34
2-935D	Allowable Adjustment of Signs and Devices Shown on the Traffic Control Plans.....	2-9.34
2-935E	Work Zone Safety Meetings	2-9.35
2-935F	Installing and Removing Traffic Control Patterns	2-9.35
2-935G	Use of High Mounted Internally Illuminated Flashing Arrow.....	2-9.36
2-935H	Use of Truck Mounted Impact Attenuation Vehicles (TMAs)	2-9.36
2-935I	Use of State Police Officers.....	2-9.37
2-935J	Use of (Remote Controlled) Changeable Message Signs	2-9.38
2-935K	Use of (Remote Control) Changeable Message Signs With Radar.....	2-9.38
2-935L	Use of Traffic Drums and Traffic Cones	2-9.39

2-935M	General Requirements for Traffic Control.....	2-9.39
2-935N	Work Zone Safety Meeting Agenda	2-9.39
2-935O	Work Zone Safety Procedures – Allowable Messages for Signs.....	2-9.41

Chapter 10 - Miscellaneous Construction - Revisions in progress Jan 2020

2-1001	Riprap.....	2-10.1
2-1002	Gabions	2-10.1
2-1003	Wire Fence.....	2-10.3
2-1003A	Wood Posts	2-10.3
2-1003B	Metal Posts.....	2-10.3
2-1003C	End, Corner and Pull Posts	2-10.3
2-1004	Metal Beam Rail	2-10.4
2-1004A	Material Inspection	2-10.4
2-1004B	Posts.....	2-10.5
2-1004C	Rail.....	2-10.5
2-1004D	Welding.....	2-10.5
2-1004E	Anchorage	2-10.6
2-1005	Turf Establishment.....	2-10.6
2-1005A	Seedbed Preparation.....	2-10.6
2-1005B	Seeding and Fertilizing	2-10.7
2-1005C	Establishment and Cleanup.....	2-10.7
2-1006	Erosion Control Matting	2-10.7
2-1007	Sodding	2-10.7
2-1007A	Ground Preparation.....	2-10.8
2-1007B	Planting	2-10.8
2-1007C	Pegging	2-10.8
2-1007D	Finishing and Maintenance	2-10.8
2-1008	Plantings.....	2-10.9
2-1008A	Coordination and Project Contract.....	2-10.9
2-1008B	Coordination Early in the Planting Season	2-10.9
2-1008C	Installation	2-10.9
2-1008D	Mulching.....	2-10.10
2-1008E	Watering.....	2-10.10
2-1008F	Staking and Guying	2-10.10
2-1008G	Semi-Final Inspection	2-10.10

2-1008H	Establishment Period and Punch List.....	2-10.10
2-1008I	Documentation of Visual Inspection by the Inspector	2-10.10

Chapter 1 - Environmental Protection

2-100 General

Protecting and improving the quality of the environment is a primary concern of the Department. During all phases of project development, through actual construction and project completion, the Department endeavors to provide for the implementation of practices and procedures that satisfy statutory and regulatory requirements to protect the quality of the environment.

All project staff should be familiar with the Standard Specifications Section 1.10 – Environmental Compliance.

2-101 Permits, Water Resource and Natural Resource Coordination

Federal and State environmental regulations for water resources apply to any activity within the boundaries of inland wetlands, tidal wetlands, navigable waters, watercourses, floodplains or floodways. Water resource and natural resource regulations apply to areas within or outside the boundaries of the project with water quality concerns, fisheries or wildlife habitat concerns. Wetlands, watercourses, and water resources and natural resources concerns are described below.

- *Wetlands.* Inland wetlands are defined in the State of Connecticut as poorly drained or very poorly drained soils, alluvial soils, or flood plain soils. The Army Corps of Engineers (ACOE) defines wetlands by using hydric soils, hydrology and hydrophytic vegetation. *Tidal wetlands* are those areas that are water ward of the Coastal Jurisdictional Line (CJL) defined and regulated by the Department of Energy and Environmental Protection (DEEP) or those areas that are water ward of the High Tide Line (HTL) defined and regulated by the ACOE or those areas above the CJL or HTL which impact tidal vegetated areas not subject to daily tidal actions or any action which may have indirect adverse impact to a coastal resource.
- *Watercourses.* Watercourse limits are defined by the DEEP and ACOE as those areas between the Ordinary High Water (OHW) limits.
- *Water Resources.* These include water quality concerns in areas which may directly or indirectly impact a wellhead protection area, public water supply watershed, aquifer protection area, sole source aquifer, or impaired water body.
- *Natural Resources.* These include natural resource concerns which may directly or indirectly impact a wild and scenic river, prime farmland, fisheries habitat or wildlife habitat.

Any construction activity within or outside any of the boundaries described above, including but not limited to, placement or removal of fill, building of any structure or roadway (permanent or temporary), is a regulated activity, and will require a permit. Construction projects may require a combination of any of the permits or registrations mentioned below.

2-101A Department of Energy and Environmental Protection (DEEP)

Some of the different types of permits and registrations issued by the DEEP are as follows:

DEEP Inland Water Resource Division Permits (IWRD): For inland wetlands, and watercourses, a “regulated activity” means any operation within or use of a wetland or watercourse involving removal or deposition of material, or any obstruction, construction, alteration or pollution, of such wetlands or watercourses, etc.

Types of IWRD Permits:

- Inland Wetlands and Watercourse Permit (IWRD)

- General Permit for Water Resource Construction Activities (IWGP)
- Flood Management Certification (FMC)
- Flood Management Exemption (FMC-E)
- Section 401 Water Quality Certification (WQC)
- PGP Connecticut Addendum
- Dam Safety

DEEP Land and Water Resources Division (LWRD): For preservation of tidal wetlands, a “regulated activity” means any of the following: Draining, dredging, excavation, or removal of soil, clearing plantings or trees, mud, sand, gravel, aggregate of any kind or rubbish from any wetland or the dumping, filling or depositing thereon of any soil, stones, sand, gravel, mud, aggregate of any kind, rubbish or similar material, either directly or otherwise, and the erection of structures, driving of pilings, or placing of obstructions, whether or not changing the tidal ebb and flow, etc.

Types of LWRD Permits:

- Tidal Wetlands Permit (TW)
- Structures and Dredging, Fill (SD)
- Structures and Dredging, Fill, and Tidal Wetlands Permit
- Certificate of Permission (COP)
- Coastal Zone Management Consistency Form (CAM)
- Section 401 Water Quality Certification (WQC)
- General Permit for Coastal Maintenance

DEEP Registrations: For Department projects with soil disturbance of one or more acres, regardless of phasing, a Stormwater Registration, Stormwater Pollution Control Plan, plan sheets and all relative Appendixes will be required. All Stormwater Registrations are signed by the District Engineer. No project can proceed until all regulatory permits and registrations have been received and approved.

An “Aquifer Protection Area” means any area consisting of well fields, areas of contribution and recharge areas, etc. An “Aquifer” means a geological formation, group of formations or part of a formation that contains sufficient saturated, permeable materials to yield significant quantities of water to wells and springs.

Types of Registrations:

- Discharge of Stormwater and Dewatering Wastewaters from Construction Activities
- Aquifer Protection Area

Note: DEEP has implemented the “ezFile” online registration system for Stormwater Discharge Permit Registrations. Effect June 14, 2016, all DOT Stormwater Discharge Permit Registrations shall be submitted to DEEP through ezFile. General information, including links for instruction on establishing accounts and permit submittal is available on [DEEP’s Stormwater Construction Page](#).

2-101B Army Corps of Engineers (ACOE)

An ACOE permit is required for activities in or affecting wetlands and navigable waters of the United States, the discharge of dredged or fill material into waters of the United States, and the transportation of dredged material for the purpose of dumping it into ocean waters.

Some of the different types permits issued by the ACOE are as follows:

- Self-Verification (SV) (previously version known as Category 1) Appendix E is issued and signed by OEP

- Pre-Construction Notification (PCN) (previously version known as Category 2) 404 Individual Permit

2-101C United States Coast Guard (USCG)

A United States Coast Guard (USCG) permit or coordination is required for activities affecting navigable waters, recreational access within coastal areas and boating access within coastal areas. When affecting navigable waters, the ACOE must also be involved.

Some of the different types of coordination letters or permits issued by the USCG are as follows:

- Advanced Approval
- Construction Letter
- Bridge Permit

2-101D Department of Transportation

When a Department project has little to no adverse impact to a floodplain, coastal boundary zone or is overseeing a local project with floodplain impacts, the Department has jurisdiction to administer permits.

Some of the different types of permits issued by the Department are as follows:

- Flood Management General - Issued by Hydraulics and Drainage Unit
- Flood Management MOU - Issued by the Office of Engineering, Hydraulics and Drainage and OEP
- DOT Coastal Consistency Review Form - Issued by OEP

2-101E Water Resources

Some of the different types of permits or letters issued when a Department project is within the limits of an area with water quality concerns are as follows:

- Water company approval
- United States Environmental Protection Agency (EPA) - Sole Source Aquifer coordination
- Department of Public Health Permit (DPH)
-

2-101F Natural Resources

When a Department project has the potential to impact an area with fisheries or wildlife concerns, prime farmland, wild or scenic rivers, the Department must coordinate these activities with the following:

- DEEP Inland Fisheries Division or DEEP Marine Fisheries Division
- DEEP Wildlife Division
- Connecticut Department of Agriculture
- United States Department of Agriculture
- United States Fish and Wildlife Service
- National Marine Fisheries Service – Greater Atlantic Regional Fisheries Office (GARFO)
- National Park Service

2-102 Pollution Control Regulations

Pollution control regulations are measures to minimize and protect the environment as a result of construction activities that may have a direct or indirect impact. Under the DOT's Standard Specifications

for Roads, Bridges, Facilities and Incidental Construction, Section 1.10 – Environmental Compliance provides additional guidance measures in protecting regulated areas.

2-102A Air Pollution

Even though there is no project-specific permit for air pollution, standards set by Federal and State regulations may apply to the Contractor activities regarding dust, fumes, mist, smoke, vapor, gas, aerosol, other particulate matter, odorous substances, or any combination of these arising from construction operations or hauling, storing or manufacturing materials. Containment plans may be required for certain procedures (for example, surface preparation for painting structures).

2-102B Noise Pollution

There is no State statute governing the maximum allowable noise level in a Department Work Zone, nor is the Department obligated to adhere to local zoning ordinances. Nevertheless, *Standard Specification* Article 1.10.05 requires the maximum allowable noise level from construction projects be 90 decibels on the “A” weighted scale (dBA) at the residence or nearest occupied building to the Site. All methods and devices employed to minimize noise are subject to the continuing approval of the Engineer.

2-102C Water Pollution Control

Water pollution control standards set by Federal and State regulations are all applicable to construction activities. At minimum, all water pollution control measures shall adhere to the erosion and sedimentation control plans provided in the contract documents, any State, Federal or Local regulations, including any regulatory permit which may have site specific special conditions associated with a project. All design measures shall comply with current Department procedures and methodologies or as outlined in the “[DEEP 2002 CT E&S Guidelines](#)” or the “[DEEP 2004 Connecticut Stormwater Quality Manual](#).” Additional water pollution control measures may be required if there are concerns regarding water or natural resource impacts.

2-102D Turbidity Monitoring

Turbidity monitoring sampling is required of all point source discharges of Stormwater from disturbed areas. All sampling points should be clearly marked in the field with flags, stakes or other visible markers. Where there are 2 or more discharge points that discharge substantially identical runoff based on similarities of the exposed soils, slope and type of stormwater controls used, up to 5 substantially identical outfalls may be identified for one representative discharge. For linear projects, 10 substantially identical outfalls may be identified for one representative discharge. Additionally, if the project is planned to continue for more than one year, the inspector as designated by the permittee shall rotate twice per year the location where samples are taken so that a different discharge point is sampled every six months. The outfall locations for sampling will be identified by the inspector, based on disturbance and approved by the engineer and the SWPCP revised as appropriate.

Turbidity monitoring shall be conducted using the drainage plan and a procedure consistent with [40 CFR Part 136](#) and may be taken manually or by an in-situ turbidity probe or other automatic sampling device equipped to take individual turbidity readings. The first sample shall be taken within the first hour of stormwater discharge from the site and at least three grab samples shall be taken during a storm event and shall be representative of the flow and characteristics of the discharge. Sampling shall be conducted at least monthly when there is a discharge of stormwater from the site while construction activity is ongoing, until final stabilization of the drainage area associated with each outfall is achieved.

Samples shall be taken during normal working hours. If a storm continues past working hours, sampling shall resume the following morning or the morning of the next working day following a weekend or

Holiday, as long as the discharge continues. Sampling may be temporarily suspended when conditions exist that may reasonably pose a threat to the safety of the person taking the sample.

Within 30 days following the end of each month, the stormwater sampling results shall be submitted on the Stormwater Monitoring Report (SMR), in accordance with NetDMR. If there is no stormwater discharge during a month, sampling is not required, however SMR's, indicating "no discharge" along with the reason, shall still be submitted as required.

Below is a hyperlink to the DEEP NetDMR web page. Check permits to verify if monitoring is required.

http://www.ct.gov/deep/cwp/view.asp?a=2721&q=481092&deepNav_GID=1654%20

2-103 Specifications

Section 1.10 of the *Standard Specifications*, "Environmental Compliance," is the primary specification for the Department's environmental protection efforts. Among other information, the section includes the "Required Best Management Practices" (BMP) for water pollution control. Other Standard Specifications that relate directly to environmental protection cover water pollution control related to soil erosion, sedimentation control, dust control, and slope stabilization.

In addition to the *Standard Specifications*, the bulk of the environmental protection efforts come in the form of Special Provisions as many projects have environmentally site specific impacts requiring coverage for items that are not provided in the Standard Specifications. These Special Provisions may include, but are not limited to the following: Fisheries enhancements, special seed mixes, habitat protection, invasive species control, inland or tidal wetland mitigation, etc.

In case of conflicts between the plans and applicable permits, the order of governance found in the *Standard Specifications*, Article 1.05.04 shall be adhered to.

2-103A Response to Environmental Deficiencies

The Office of Environmental Planning (OEP) is the primary office in the Department for environmental oversight. The District Office is responsible for all permit administration during construction. It is the policy of the Department that immediate action is to be taken to correct any activity that is causing harm, damage, or adverse impact to the environment that is beyond what was contemplated by the permits.

Also, when directed either verbally or in writing by District Environmental Coordinators, OEP, DEEP or other regulatory agency staffs, the Inspector and District staff must take corrective action whenever verbal or written deficiencies are brought to their attention. The Inspector and District staff should not wait for written confirmation of verbal directions from the Department or regulatory environmental staff.

Upon receipt of verbal or written notification of any deficiencies, the Inspector must immediately notify the Contractor of the deficiency, required corrective action and response time required of the Contractor.

This is in compliance with [Department Policy No. EX.O-29](#) "Policy Concerning the Processing of Environmental Permits and Permit Compliance for all Aspects of Project Development, Construction, and Operations."

The Inspector **does not** have the authority to decide which environmental deficiencies should be responded to. They are required to take immediate action and respond to all deficiencies brought to their attention by Department or regulatory agency environmental staff. If Inspector has any concerns that the actions required by environmental or regulatory staff are unnecessary, they are to implement the corrective actions

as directed by the environmental or regulatory staff and then bring their concerns to the attention of District supervisory personnel.

In the event concerns are raised regarding the necessity for correcting environmental deficiencies, the concerns shall be brought to the District Environmental Coordinator and the Project Engineer's attention. If the District supervisory staff feels that the corrective action is not appropriate, the Transportation Supervising Engineer (TSE) will contact the Department's environmental planning office and discuss the District's concerns. If necessary, a meeting will be arranged between OEP, District personnel and the regulatory agency to discuss the issues raised by the District.

It is imperative that all personnel respond in an immediate and positive manner whenever environmental deficiencies are noted by Department or regulatory personnel. These deficiencies must also be recorded in the Construction Site Environmental Inspection Report (CSEIR),

2-104 Duties and Responsibilities

The Office of Construction (OOC) in conjunction with District and the Inspector have the primary responsibility of ensuring that construction activities are conducted in compliance with applicable environmental regulation required. On larger projects or if special requirements prevail, a full-time Environmental Inspector may be required. In addition, each District has a full-time Environmental Coordinator.

2-104A Qualified Inspection Personnel

During construction, the Inspector is responsible for compliance with the procedures of the Department and the Standard Specifications, as well as compliance enforcement of the rules and regulations set forth by the regulatory agencies. Permits issued by the DEEP and ACOE are to be complied with unconditionally. If any questions arise, OEP or Design shall be contacted.

Inspection personnel must maintain communications with the Contractor to alleviate problems with the interpretation of permit conditions and contract specifications concerning environmental conditions. Recordkeeping need not be lengthy but must be complete and precise. Any problems or questions may be referred to the Project Engineer and/or District Environmental Coordinator.

2-104B Inspector

The Inspector responsible for environmental compliance performs the following work:

- Monitors project compliance with permit requirements, Section 1.10 of the Standard Specifications; Contractor's submitted procedures, and any other regulatory agency requirements and best management practices.
- Ensures controls are in place prior to the initiation of construction activity in or adjacent to regulated areas.
- Maintains the project's Environmental Log and the New Project Start Up sheet.
- Reviews erosion and sedimentation plans at least weekly and after any rainstorm of 0.1 inch and as stated in DEEP permit. If prolonged rainstorms occur daily inspection should take place.
- After receiving oral or written notification of a deficiency, immediately notifies the Contractor of the deficiency, the required corrective action, and the required response time.

2-104C District Environmental Coordinator

The District Environmental Coordinator is responsible for the following:

- Perform periodic site reviews on construction projects for compliance with regulatory permits, plans and specifications.
- Keeps the DE and ADE informed of environmental regulatory requirements.
- Immediately notifies the DE and ADE of their findings from outside review.
- Notifies the DE and ADE of actions required to avoid or correct environmental impact due to construction activity.
- Performs design reviews, where applicable, on proposed projects for constructability and environmental compliance.

2-104D District Office

The District is responsible for ordering the contractor to take the actions needed to avoid environmental damage or to repair damage that has occurred or is occurring. In addition, the DE reviews materials incorporated into a project as required ensuring full compatibility with environmental requirements.

2-104E Office of Environmental Planning

Duties of the OEP are to review design plans to ensure projects are properly implementing erosion and sedimentation control measures, stormwater quality measures, minimizing impacts to wetlands or floodplains, minimizing impacts to water or natural resources and checking on any constructability issues with regards to impacts to a wetland, a water or natural resource. Simultaneously, the permit process begins during the design review and planning process. The OEP coordinates the evaluation, reviews and comments as necessary for environmental decision-making with the designers and other interested parties. Processing permit applications or determining that a permit is required usually takes a significant time. OEP has instituted standard procedures and individual environmental guidelines to improve interagency working relationships to expedite permit application processing through the LEAN initiative process. Based on the level of impact a project may have, the regulatory agencies may implement mitigation measures such as creating fisheries enhancement measures or wildlife habitat, wetland creation sites or wetland enhancement sites, invasive species removal and control, provide landscaping or implement a time of year in-water restrictions.

Once in construction, OEP may request a separate environmental meeting outside of the pre-construction meeting if warranted. OEP will periodically perform site inspections of construction projects to ensure erosion and sedimentation control measures are properly being implemented, site stabilization or permit compliance. Any deficiencies encountered will be written signed memo to the District outlining recommended remedial action. The Director of Environmental Planning may issue a directive to the DE if the District does not act promptly.

2-104F Contractor

The Contractor must comply with the conditions set forth by DEEP and ACOE permits and is responsible for the compliance of all subcontractors that may be involved on a project. Permits take precedence over project specifications and plans.

In addition, Federal and State regulations must be followed on site and off site. Areas such as borrow banks, waste disposal sites and staging areas must conform to Federal and State regulations regarding erosion and sedimentation controls; noise, air quality, water pollution control; and toxic or hazardous wastes. Failure to comply may leave the Contractor liable for fines or other punitive measures.

2-105 Permit Process

Coordination with the designer for the determination of permits required for a project should begin early in the design process. When conducting plan reviews it is important to note any areas of temporary or permanent impact where a permit might be required. If the Designer has determined that the project may impact a wetland, a survey request is initiated for OEP (through Central Surveys) to conduct a wetland delineation of a project site. Once the wetland limits have been identified, a survey ground file is developed and imported in the contract plans.

No contract can be awarded to a Contractor until all regulatory approvals are in place.

2-105A Department of Energy and Environmental Protection (DEEP)

In general, when a permit application is received by the DEEP, a field review is conducted, and the application is reviewed for accuracy. The time needed for approval of a DEEP permit varies. A project with extensive environmental effects requires a greater review period. In extreme cases, the DEEP may request a change in design to lessen the environmental effects of a project.

Certain projects will require a public notice in the locality of the project site to allow the public an opportunity to respond or request more information. This is only after the permit has been screened and tentatively approved internally within the DEEP. If enough signatures are generated as a result of the public notice, a public hearing is scheduled to allow discussion among the CDOT, DEEP and those requesting more information. If there is no response, the Commissioner of DEEP may choose to waive the public hearing and authorize approval of the permit. Only after the DEEP has reviewed and approved the permit(s), will the ACOE approve and issue their permit for the Department.

Also, DEEP may add project “commitments” or changes to the design based on a Public Hearing or Local Municipality request and include such “commitments” through a permitting special condition.

2-105B Army Corps of Engineers (ACOE)

There are two avenues for ACOE permitting in the State. General Permits (GP) and Individual Permits (IP). General Permits are divided into two categories and are for projects which will have no more than minimal environmental impacts. The two categories of General Permit are Self-Verification (SV) (formerly known as Category 1) and Pre-Construction Notification (PCN) (formerly known as Category 2). Recent changes to the ACOE General Permit include the authorization of impacts by activity type in which a separate general permit is issued for each activity, meaning that a single project could have multiple ACOE GP’s., projects with larger magnitude impacts are issued as individual permits. All ACOE permits are issued under Section 404 of the Clean Water Act and can be interchangeably referred to as “404 Permits”. All projects are screened by the OEP to determine which ACOE Permit is appropriate. All permits (GP and IP) are submitted to the ACOE for authorization. Written authorization is sent to the Department for all PCN and Individual Permits; SV permits are registration only and may not receive any written authorization from the ACOE. PCN and Individual Permits may or may not have the same time of year restriction and projects on coastal or tidal waterways may have different time of year restrictions.

2-106 Review of Contract Documents

The Project Engineer and the Environmental Coordinator should review all contract documents prior to the advertisement of the project. If the construction includes a permitted activity, the permit application should be checked against the project plans for accuracy. A field review, with the complete permit package and a set of plans, should be made shortly after award of the Contract and prior to the Preconstruction Meeting. If any discrepancies are found, the designer and Environmental Planning must be notified.

The Contract will contain items for sedimentation and erosion controls, slope stabilization and dust control, even if no permit is required. Quantities may require adjustment because of site conditions and factors such as weather. Clearing limits should be noted. Accessibility of the site, property agreements and utility involvement should all be verified prior to construction.

2-106A Preconstruction Meeting

The Preconstruction Meeting gives the contractor an opportunity to become acquainted with the Department staff as well as any regulatory agency staff that will be intimately involved with the subject project. Establishing responsibility, authority, and lines of communication are primary goals of the meeting. At the time of the preconstruction meeting all contract documents should be in place. A review of the contract plans, Special Provisions, and permits must be coordinated with the Project staff and the District Environmental Coordinator.

Special attention must be given to any commitments made during the planning / scoping phase, and emphasis placed on erosion controls. At this time, potential issues should be identified and a process for resolution be established.

The following items from the Contractor must be received by the District no later than the Preconstruction meeting:

- Signed Stormwater Pollution Control Plan (SWPCP) certification
- Erosion & Sedimentation Control Plan (If no SWPCP is provided)
- Disposal sites
- Field office and Laydown area plans
- Flood Contingency Plan (If Applicable)
- Emergency contact list

Submittals are requested, as needed, from the Contractor for items such as:

- Erosion and Sedimentation Control Plan (Winter Erosion and Sedimentation Control Plan)
- Dust Control Plan
- Construction Sequencing Plan
- Water Handling Plan
- Flood Contingency Plan
- Dewatering Plan
- Spill Prevention and Remediation Plan
- Stormwater Pollution Control Plan
- Vehicle Emissions Plan
- Demolition methods
- Noise mitigation plan
- Additional waste disposal sites
- Storage area(s)
- Field office locations

Plan submittals that do not conform to those specified in the permit application, such as those for dewatering or cofferdam systems will require a written modification from the regulatory agencies.

Disposal site submittals are required for all construction and demolition debris including but not limited to: bituminous concrete & millings, concrete, woodchips & stumps, surplus soil, steel, etc. For waste disposal sites, a map of the area(s) is required showing property features, wetlands and watercourses, etc., along

with any permit approvals from State or local agencies and an authorization letter from the private property owner if not owned by the Contractor.

The Contractor must be supplied with emergency telephone numbers for the DEEP Oil and Chemical Spill Unit. Permit conditions may require an on-site supply of absorbent materials for use during construction. All projects in or over water, within public water supply watersheds, wellhead protection areas and aquifer protection areas must have on-site absorbent materials as required by the Contract documents and permit. The Inspector should receive a copy of the permit package, emergency telephone numbers and other related documents.

2-106B Site Preparation

When an item for clearing and grubbing exists, the Contractor must mark the clearing limits, wetland limits and the toe of slope of the site. The Engineer must verify the limits prior to any clearing activities, as per Section 2.01 of the *Standard Specifications*.

A tree clearing meeting and walk through with the Contractor, municipal tree warden, DOT Landscape Design unit, DOT District Maintenance Certified Arborist, Project Engineer, Inspector and District Environmental Coordinator is to be held prior to any clearing at a minimum of 7 days for state-owned property or as per local agencies for municipal property, prior to clearing operations.

2-107 Permit Modifications

A permit is issued based on the temporary or permanent wetland impact and fill within a floodplain and information supplied in the permit application. If a project increases the wetland or floodplain impacts in any manner, a permit modification is required. A permit modification is a new permit submittal to the DEEP for review and approval. If required, a permit modification may be subject to public notice and new public hearing. If the permit modification is submitted to the DEEP in a timely manner, the construction of a project may proceed until permit modification approvals are received by the Department.

If the Contractor requests the change, it must be reviewed by the District to determine its feasibility. If the change is approved by the District, the District must submit the request in writing to OEP for a determination. If the OEP agrees with the District on the requested change, it will be the Contractor's responsibility to draft the permit application for Department review and comment. The final draft application should be forwarded from the District in writing to OEP to process then to the DEEP for review and approval. No work associated with the requested permit change is to be done until written approval is received. All work associated with the original permit with no change is allowed to continue.

If the requested change is through the Department, then the OEP will work with the Department's design engineer in drafting a permit for final approval through the regulatory agencies.

2-108 Procedure for Requesting Technical Plan Revisions, Notifications or de Minimis changes to DEEP Permits or ACOE Permits

A Technical Plan Revision, For Your Information, or de Minimis change is defined as minor in nature to a permit which neither increases the wetland or floodplain impacts. Coordination is mandatory between the OEP, Design, the Contractor, and the District for any modifications relating to changes to permit plans, permit plates or permit applications on projects with permits issued by DEEP or ACOE.

The construction plans, permit plans or permit plates must match with no discrepancies. In cases where there is a discrepancy, the permit plans, permit plates and permit application supersede the plan. (Any discrepancy should be reported to the District, and no work shall proceed until the issue is resolved.)

2-108A Technical Plan Revisions or Notification

A Technical Plan Revision or Notification, or as it was previously called “For Your Information (FYI)”, is administered through the DEEP’s Inland Water Resources Division and only applied to permits issued by that particular office. When a change or modification to a permit special condition, permit plan, or permit application has been identified or is being requested, the Inspector shall notify the District Environmental Coordinator to determine course of action immediately. The District Environmental Coordinator has the right to reject changes or modifications without notification or approval by OEP. If the District Environmental Coordinator deems a change or modification requires coordination with OEP for DEEP review and approval, the District must submit in writing a memo signed by the District Engineer or Assistant District Engineer to OEP Division Chief highlighting who is requesting the change, reason for the change and added benefits because of the change as well as providing revised permit plans, permit plates or permit applications outlining the change. If the modification requires changes in hydraulics, supporting drainage calculations will be required. If the issue is Department related, then the Department is responsible to provide the requested information. If the issue is being proposed by the Contractor, then the Contractor is responsible for providing the requested information.

Upon receipt, OEP can reject or approve the change or modification. If approved, OEP will draft a memo and determine the type of submittal request to be sent to the DEEP. If the submittal requires a Technical Plan Revision, a formal approval letter from the DEEP will be forthcoming and no work will be allowed until written authorization is received. If the request is a Notification, no formal letter from the DEEP will be forthcoming and work may proceed.

Changes requiring a Technical Plan Revision or Notification may include, but are not limited to the following:

- water-handling
- cofferdams
- time of year waiver
- embankment stabilization
- drainage modifications

If there is additional impact to inland wetland or floodplain, a permit modification will be required. See Section 2-107.

2-108B de Minimis Change

A de Minimis change is administered through the DEEP’s Office of Long Island Sound Program and only applies to permits issued by that particular office. When a change or modification to a permit special condition, permit plate, or permit application has been identified or is being requested, the Inspector shall notify the District Environmental Coordinator to determine course of action immediately. The District Environmental Coordinator has the right to reject changes or modifications without notification or approval by OEP.

If the District Environmental Coordinator deems a change or modification requires coordination with OEP for DEEP review and approval, the District must submit in writing a memo signed by the District Engineer or Assistant District Engineer to OEP the highlighting who is requesting the change, reason for the change and added benefits because of the change as well as providing revised, permit plates or permit applications outlining the change. If the modification requires changes in hydraulics, supporting drainage calculations will be required as well. If the issue is Department related, then the Department is responsible to provide

the requested information. If the issue is being proposed by the Contractor, then the Contractor is responsible for providing the requested information.

Upon receipt, OEP can reject or approve the change or modification. If the submittal requires a de Minimis change, a formal approval letter from the DEEP will be forthcoming and no work will be allowed until written authorization is received.

Changes requiring a de Minimis change may include, but are not limited to the following:

- water-handling
- cofferdams
- time of year waiver
- embankment stabilization
- drainage modifications

If additional impact to a tidal area is anticipated, a Certificate of Permission will be required with the potential for new special conditions or tidal mitigation. For further information regarding new permit modifications, see Section 2-107.

2-109 Controlled or Hazardous Materials

Controlled or hazardous materials can be present (known) or encountered (unknown) in the soil or groundwater during construction activities. In addition, contractor releases/spills can occur at the jobsite, and procedures must be followed to handle these occurrences.

2-109A Known Materials on Site

Subsurface conditions are evaluated during design to determine if controlled or hazardous waste materials might be present. If contamination is suspected, subsurface investigations, sampling and material analysis are performed by a specialty firm under a contract with the Department. Depending on the nature and the extent of the findings, the Department may arrange for handling and disposal of the material prior to advertising the construction contract, or it may require the Contractor to handle and dispose of the material through special contract items.

Check each contract individually for the procedures to be followed. The regulations for handling and disposing of controlled or hazardous materials are stringent and subject to change.

Construction operations regarding the handling, storage, and disposal or rehandling of these types of materials are coordinated through the Office of Environmental Compliance.

2-109B Unknown Materials on Site

Materials of unknown origin may be uncovered during construction. Any odorous, discolored or otherwise unusual material requires further investigation. Work in the area is stopped, and the District, Office of Environmental Compliance, and the DEEP Spill Response Unit are notified in accordance with the notification procedures outlined in Section 2-109C.

The importance of the notification procedures cannot be overemphasized. The costs associated with handling and disposing of controlled materials is significant. Mishandling these materials, even with the best of intentions can expose the Department to potential liabilities.

Caution is needed to prevent personal injury or spread of contamination. No material that is suspected of contamination shall be removed from the site until cleared by the District and Office of Environmental Compliance. The Office of Environmental Compliance coordinates the required sampling of the material and arranges for disposal.

No one other than the Office of Environmental Compliance or its designated consultant is to explore or investigate the site. Construction personnel are prohibited from taking samples of material that can be potentially contaminated or hazardous waste. This includes touching, smelling or tasting suspect materials, climbing into trenches or enclosed areas where hazardous wastes are suspected, or uncapping or probing tanks, containers or drums.

Exploration and investigation (including sampling and testing) will be done by specialized consultants and workers who are fully trained and licensed for hazardous waste work in accordance with Federal and State regulations.

After the site has been characterized, the Office of Environmental Compliance will direct the District as to the course of action that must be followed in areas of environmental concern.

2-109C Contractor Spills

The contractor should be following the Project's approved Spill Prevention Plan and Remediation Plan. However, equipment malfunction, an error in judgment during refueling, etc., can cause a spill. The same notifications must be made as outlined in Section 2-113, "Contractor Noncompliance." A contractor may be held liable for all costs incurred in the event of an accidental spill, including containment, testing, cleanup and disposal of materials. Disposal of material must be in accordance with Federal and State regulations and should be addressed on the contractor submitted plan. Any size spill is considered a "release" by State Law and must be addressed.

All projects in, over or adjacent to watercourses must have absorbent materials available in accordance with contract requirements. In some instances, an absorbent boom may be required to be installed along the banks of a watercourse and be maintained throughout the project duration.

2-109D Emergency Response Procedure

When an environmental problem or concern arises, the following procedures are to be complied with:

Normal Hours (8:00 AM to 4:00 PM)

- Stop work immediately at that location.
- Protect the excavated area or contain the spill without jeopardizing the safety of personnel.
- If the Contractor has a site specific health & safety plan, they should follow the procedure identified within
- Notify the District Environmental Coordinator immediately.
- Notify the Office of Environmental Compliance at (860) 594-3404 stating the situation.
- Coordinate with DEEP if required or instructed to do so.

After Hours (4:00 PM to 8:00 AM)

- Stop working immediately at that location
- Protect the excavated area for safety.
- If material or the spill is contained and in no danger of migrating, secure the site for the night.
 - The Project Engineer should be contacted immediately.
 - Notify Division of Environmental Compliance/ District at beginning of next work day.

- If the material is migrating or has a threat of migrating, or the spill is uncontrolled notify DEEP Emergency Response (860) 424-3338 or 1-866-337-7745 stating the situation.
 - Be sure to ask for the ID # of the CT DEEP contact, especially if direction is given over the phone.
 - Provide any direction received to the Contractor
 - Process a Telephone Call Report for future reference
 - Notify the Office of Environmental Compliance, District and others as listed on the project emergency call list immediately.
- Be prepared to report the chain of events and the mandatory information such as name of DEEP agent, if applicable, contractor and equipment used, spill report, etc. If DEEP Oil and Chemical responds to the Project they have authority over the spill and other potentially affected areas.

2-110 Structure Painting Debris

Projects with activities impacting painted surfaces involve containment and collection of surface preparation debris, lead compliance and disposal of debris. Each contract dealing with painting of structures contains special provisions pertinent to a particular site or sites. Since specifications are frequently revised based on most up to date regulations or for site specific concerns, refer to the Contract for complete information for a specific project. Contact the Supervising Engineer if the specifications appear to be older versions.

2-110A Containment and Collection of Surface Preparation Debris

The Contractor is required to submit Working Drawings for the containment and collection of surface preparation debris to the District for review and comment. The working drawings must be signed by a Connecticut Professional Engineer. The drawings must include complete details for all materials, support-system framing and dimensions. The enclosures must be wind-resistant and must be designed and erected to contain, as well as facilitate, the collection of debris resulting from the surface preparation. Abrasive blast-cleaning can proceed only within containment enclosures approved by the Engineer and must not proceed until approval has been obtained. See Volume 2, Chapter 8, "Structures," for additional information about containment and collection.

2-110B Lead Compliance

All contractor employees who perform work impacting lead paint shall be properly trained to perform such duties in accordance with OSHA Lead in Construction Regulation, USEPA RCRA Hazardous Waste Regulations and CTDEEP Hazardous Waste Regulations.

2-110C Disposal of Hazardous or Non-Hazardous Debris

Each contract contains complete specifications for disposing of debris. General guidelines are as follows:

Typically, lead painted surfaces are sampled and characterized in the design phase of a project and the appropriate specifications are incorporated into the Contract. In certain instances during construction, the Department may sample debris resulting from activities impacting painted surfaces, as directed by the Office of Environmental Compliance

The contractor must conform to the latest Hazardous Waste Regulations prepared by the DEEP, subject to regulations adopted pursuant to Chapter 445 Sections 22A-114 to 22A-134Z of the *Connecticut General Statutes*.

Disposal of the debris after sampling must be in strict conformance with the current regulations of the Environmental Protection Agency and Connecticut Department of Energy and Environmental Protection. Storage containers must conform to Federal and State Regulations. The container must not have any indentation or damage that allows seepage of the material contained in it.

2-110D Non-Hazardous Debris

Debris that is determined to be non-hazardous must be disposed of in accordance with applicable specifications. Non-hazardous debris may be stored at the site until completion of the steel-surface cleaning operations. Then the Contractor shall arrange for the non-hazardous debris to be disposed of in an approved manner at an authorized site.

2-110E Hazardous Debris

Debris that is determined hazardous must be placed in approved containers and sealed in an approved and secured staging area. Handling and disposal must be in accordance with applicable specifications. A temporary EPA identification number must be obtained from the Division of Environmental Compliance. The Division can provide a current list of approved hazardous-waste transporters and approved hazardous-waste disposal facilities. Disposal of hazardous waste must be completed within 90 calendar days of the date on which it began to be accumulated in the approved container(s).

2-110F Miscellaneous Construction Debris (Clean Waste)

The excess materials generated on the project cannot be hauled off the project site unless a disposal site has been proposed by the contractor and approved by the District.

Submittals required for approval of the disposal site by the District (in compliance with Article 1.10.03-6 of Environmental Compliance and Department of Environmental Protection Permit Conditions) are:

- Site Map
- Letter of permission from property owner
- Local inland wetland approval
- Approximate amount of material for disposal
- U.S.G.A. quad map of site
- U.S.D.A. soil map

The contractor must ensure that the material for disposal is not placed in an area of higher water quality than the area where the material was removed.

2-111 Sedimentation and Erosion Controls

The contractor is required to submit an “Erosion and Sedimentation Control Plan” and a “Dust Control Plan” to the Engineer for approval. A separate plan must be submitted for winter activities, if anticipated.

These plans must contain the placement locations, the types of controls being used, and a maintenance schedule. Although placement of controls is depicted on plan sheets, adjustment may be needed for actual field conditions. Modifications made to the Sedimentation and Erosion Control system should be recorded on construction plans in accordance with the *Connecticut Guidelines for Soil Erosion and Sediment Control* and Contract Permits.

After approval of the plan, the controls are installed prior to any construction activities that will cause a disturbance of the surface and possible erosion problems. Proper installation is crucial for the effectiveness

of any sedimentation control. Silt fences must be firmly staked and buried to the depth specified by the manufacturer. If the ground is frozen, the fence may be backfilled using available material. Hay bales must be trenched and securely staked, and any spaces between the bales filled with loose hay. Controls are inspected regularly for effectiveness, with special attention prior to, during and after storms. Any failures to the system must be repaired immediately. For additional methods of sedimentation and erosion control, refer to the *Connecticut Guidelines for Soil Erosion and Sediment Control*, prepared by the Connecticut Council on Soil and Water Conservation, and the CDOT *On-Site Environmental Mitigation for Construction Activities*.

If changes are made to the contractor's scheduled activities, or if staging sequences are altered then the sedimentation control plans must be revised to ensure compliance with the regulatory permit, plans and specifications.

2-111A Handling Water

On construction projects that require work in a watercourse, the contractor must submit their plans to manage the flow in a manner consistent with any regulatory agency wetland permits associated with the project. This plan should include location and the size of discharge basin, pump size, method of installation and removal of the water-handling-cofferdams. Other methods consistent with the permit conditions will be considered, a request for permit Technical Plan Revision or FYI to the regulatory agencies may be made in accordance with *Standard Specifications*, Section 1.10 – Environmental Compliance.

Water handling plans are normally designed at a minimum to “pass” a 2 year storm event. However for water handling plans anticipated to be in place for more than 6 months, the design must be reviewed and designed in accordance with the CDOT Drainage Manual.

The contractor is required to submit a flood contingency plan when working within a watercourse or flood prone areas. This plan is normally reviewed and commented on by the District Environmental Coordinator in concert with the OEP.

2-111B Dewatering

A dewatering plan may be required for approval when ground water is encountered during excavation or during installing a cofferdam. The plan should include method of installation and removal, location and the size of discharge basins and the pump size. All plans submitted by the contractor must be approved by the District Environmental Coordinator and the OEP prior to installation of such plan.

2-111C Slope Stabilization

There are many effective methods of slope stabilization. They range from the simple method of seeding, mulching or tracking to more complex methods, such as erosion control matting or stone blanket. A specific method may be shown on the plans but prove unworkable due to field conditions. Changes to the slope treatments adjacent to the regulated areas must go through the Technical Revision process, even though the area is not within the regulated area. Refer to the sources listed in Section 2-111 “Sedimentation and Erosion Controls” for additional methods and installation procedures. If stone blanket is chosen, ensure that the toe of the slope does not change from the original permit area, or a modification will be needed. All exposed soil shall be stabilized in accordance with the Standard Specifications Section 1.10 – Environmental Compliance – Article 10.03.

2-112 Water Pollution Control

Section 2.10 of the *Standard Specifications* is titled “Water Pollution Control (Soil Erosion).” The intent of the item is to establish a fund for pollution control work required but not a part of the original contract or to increase quantities of items related to pollution control.

Payment for work and materials for the construction, application and installation of water pollution control measures is made under the applicable contract items. If there is no applicable contract item, the work is paid as extra work and must be incorporated by Construction Orders on an item-by-item basis as new items. Volume 1, Chapter 3, “Project Documentation,” includes additional information about the administrative procedures for water pollution control items.

2-112A Off-Site Locations

The contractor is responsible for the proper environmental maintenance of all off-site locations used during construction. Off-site locations may include, but not limited to, borrow banks, staging areas, etc. The Inspector must be aware of all off-site locations and monitor them for compliance within the rules and regulations set forth by the CDOT, the DEEP and any applicable local ordinances.

The contractor is responsible for obtaining any permits required for the off-site locations.

If project material is intended to be re-used within the project limits, it must be monitored and kept separate from all other outside sources of material, otherwise it will be considered a new source of material and will be required to be tested.

2-112B Storage of Materials and Equipment

Materials and equipment must be stored in a manner that is secure and environmentally sound. Materials that can cause pollution of air, water or soils must be kept in a manner to prevent vandalism and contamination. No equipment or material shall be stored, fueled or repaired within 50 feet of any wetland or watercourse. Use of a floodplain area for field office location or storage requires the approval of the regulatory agencies.

Spills must be reported as detailed in Section 2-109 “Contaminated or Hazardous Materials.”

Storage of materials which are buoyant, hazardous, flammable, explosive, soluble, expansive, radioactive, or which could be injurious to human or plant life in the event of a flood shall not be allowed below the 500 year flood elevation. No storage of material or staging areas shall be allowed below the 100 year flood elevation without a permit from DEEP. Exceptions to the above restrictions may be granted by DEEP.

2-113 Contractor Non-Compliance

2-113A Department Authority

The following quote is from the *Standard Specifications* Section 1.10 - Environmental Compliance, and applies to construction activities and the conformance of the contractor with environmental permit requirements.

“In the event that the Contractor fails to maintain such devices in accordance with said documents, and the Contractor does not correct such a failure within 24 hours after receipt of written notice of such a failure from the Engineer, the Department may proceed with its own or other forces to remedy such failures. The

cost to the Department of curing any such specified failure will be deducted from monies owed to the Contractor under the Contract or under any other State contract.”

This authority provides the Department with a measure of control over an uncooperative contractor. It generally is used when all other methods of dealing with the contractor fail.

2-113B 24-Hour Rule

The District is responsible for ordering the contractor to take the action necessary to avoid environmental damage or to stop and repair damage that has occurred or is occurring. If the contractor does not act within 24 hours of the time notified, the DE or ADE must use approved forces to do what is necessary and then charge the project contractor for the work.

The 24-Hour Rule Form is issued to the contractor immediately when environmental damage is occurring or has occurred. The Inspector issues the form when the damage is first observed but after the Inspector gets oral approval from the District Environmental Coordinator, DE, or ADE.

The 24-hour rule must be issued if a contractor fails to address a problem or deficiency within time period ordered or approved. If it becomes necessary to engage an outside firm to resolve an environmental problem, the following procedure will be followed.

Once the [24-Hour Rule Form](#) (CON-142) has been issued, if the contractor does not resolve the environmental problem within 24 hours, then send a copy of the completed form to the Office of Construction and the Office of Environmental Planning.

District notifies Construction Administrator or Construction Division Chief of need to obtain other forces to resolve environmental problem. District is to provide details on the extent of work required to resolve problem and estimated cost.

The District may be advised to coordinate with Maintenance and/or secure a private firm to complete the work. If the District is directed to contact private firms, they are to advise the firms that prevailing wages must be used. The following are allowable options for the District’s selection of a private firm:

- When possible DAS contracts shall be used to complete the work.
- For Work under \$1,000 the District may obtain any firm to complete work.
- For work under \$10,000 but greater than \$1,000 the District will be required to obtain three telephone or email quotes unless work can be substantially completed by DAS contract(s). Time can be used as the award criteria.
- For work over \$10,000 one of the following will happen:
 - The District will be directed to obtain a DAS vendor to complete the work if the work can be substantially completed with an existing DAS contract.
 - The District, with the approval of the Construction Administrator, will assign the work to another contractor which is adjacent to or in the area of the work to be performed.
 - The District will be directed to obtain three telephone quotes or emails to complete the work and author a memorandum from the Bureau Chief to the Director of Purchasing and Materials Management requesting Standardization Committee Approval. In this case the District may be directed to start the firm prior to formal approval.
 - The Commissioner will enact an Emergency Declaration.

When District is directed to obtain a firm(s) to complete the work the District will:

- prepare Purchase Requisitions and obtain Emergency Purchase Order Numbers when required.
- inform the firm of Purchase Order Number.

- mark the Purchase Order as confirmed once they provide firm with Purchase Order Number.
- send all required paperwork to Purchasing.
- process all required invoices.
- deduct costs from payments due Prime Contractor.

2-114 Reports and Recordkeeping

2-114A Environmental Checklist/ Construction Site Environmental Inspection Report

Various Permits require that environmental controls on construction projects be monitored and maintained in working condition. Some DEEP permits require the submission of reports to document that environmental controls are being monitored and maintained. In the past, the accuracy of these reports and the lack of documentation to demonstrate that sedimentation and erosion control problems are being resolved in a timely manner have been lacking.

An “[Environmental Check List](#)” form and “[Construction Site Environmental Inspection Report](#)” form are to be used on all projects to document the monitoring of environmental controls. (See the Approved Forms folder).

The following are guidelines to document that environmental controls are being monitored and maintained:

The “Environmental Check List” form shall be filled out at the beginning of the project and maintained in the Project Environmental Log. It is to be updated as various items are achieved. This form provides a quick reference of the status of various items.

On a weekly basis and within 24 hours of a storm event greater than 0.1 inch (and as required by permit(s)), District personnel shall inspect the project site and report on the condition and adequacy of environmental controls. The “Construction Site Environmental Inspection Report” (CSEIR) shall be used for this report and these reports shall be maintained in the Project Environmental Log. Problems and deficiencies found during environmental inspection must be clearly stated on the form. Use additional sheets if necessary. The “Construction Site Environmental Inspection Report” forms shall be updated as the problems and deficiencies are resolved by noting the date/time corrective work completed or action taken. **Problems and deficiencies identified are not to be left unresolved.**

Environmental coordinators may routinely perform field reviews of project sites. These reviews may be performed on a monthly or weekly basis as the environmental sensitivity of the project dictates. It is suggested that occasionally in conjunction with the field review an environmental meeting be held with the Project Engineer and field inspector(s) to identify and discuss sedimentation and erosion control problems on the project.

Upon conducting a field review, the Environmental coordinator may prepare a Construction Site Environmental Inspection Report for the project environmental log unless the review is in conjunction with an environmental meeting, in which case the Project Engineer or field inspector may prepare the report.

Environmental coordinators are to review project environmental logs each time they perform a field review of a project. The coordinator shall check the log to see if problems are being corrected.

On a monthly or biweekly basis depending on the environmental sensitivity of a project the “Construction Site Environmental Inspection Reports” are to be reviewed by the Environmental Coordinator or Project Engineer. The reviewer shall sign the “Reviewed By” line on reports that have been completed. Complete reports are only those where all problems and deficiencies noted have been resolved and date/time of correction or action taken indicated.

On a monthly basis, the inspector shall forward to the environmental coordinator, on projects that require monitoring under permits, a signed copy of the following Construction Site Environmental Inspection Reports:

- All reports prepared for that month
- All remaining reports that have not been accepted, with the "Reviewed By" line not signed

The environmental coordinator shall review all CSEIR'S within the Environmental Log to ensure all outstanding issues have been addressed in a timely manner. Any issues that were not resolved shall be brought to the Project Engineer's attention and if not addressed immediately, escalated to a higher level.

For problems/deficiencies noted where environmental damage has not occurred, the field inspector shall issue a field memorandum with a due date for addressing noted problems/deficiencies. If there is any question regarding the appropriate response time, an immediate response can never be inappropriate.

A contractor may request additional time to correct a problem or deficiency. Additional time may be granted only if the contractor can document that delays were encountered through no fault of their own.

2-114B Recycling Report for Construction Projects

Recycling reports should be filled out for projects generating wood, steel, glass, and demolition debris. Reuse on or off the project must be reported every six months on the form by tons recycled. See Volume 1, Chapter 3, Section 1-326 which includes a link to the form and instructions for completing it.

2-114C Recordkeeping

The Inspector should maintain a separate environmental folder on the construction site. The folder should contain the following documents and information:

- The Environmental Log Construction Site Environmental Inspection Reports (CSEIR)'s;
- The Environmental Checklist-New Project Startup form;
- All environmental permits and revisions;
- All memorandums and directives that pertain to environmental aspects of the project;
- The General Stormwater Permit, including a set of plans for recording changes;
- DEEP numbers for spills and other numbers;
- Any correspondence pertaining to the environmental aspects of the project; and
- Complaints of an environmental nature.

2-115 Procedures Relating to Emergency Declaration Projects

Section 13b-26(f) (2) of the Connecticut General Statutes (CGS) authorizes the Commissioner of the Department of Transportation (Department) to declare "...that an emergency condition exists on any highway in the state which demands immediate attention to insure the safety of the traveling public..." The specific type of emergency will be dictated by the immediate impact to the safety of the traveling public.

Immediate Emergency Repair - A natural disaster, structural failure, rock slide, etc., any of which require the Department, either through its own resources or contractual services, to take action by mobilizing the necessary resources as quickly as physically practical, very often within hours of the event. Work should typically begin within 30 days.

Once an emergency situation has been declared by the Department Commissioner, section 22a- 6k(a) of the CGS authorizes the Department of Energy and Environmental Protection (DEEP) to issue emergency authorizations for activities regulated under Stream Channel Encroachments, Water Diversions, Dam

Construction, Tidal, and Inland Wetlands. An emergency authorization may be granted when DEEP finds that "...such authorization is necessary to prevent, abate, or mitigate an imminent threat to human health or the environment..." and that "such authorization is not inconsistent with the federal Water Pollution Control Act, the federal Rivers and Harbors Act, the federal Clean Air Act or the federal Resource Conservation and Recovery Act." Section

22a-363d authorizes DEEP to issue emergency coastal permits in situations which may result in "...immediate, unforeseen and unacceptable hazards to life, health or welfare or significant loss of property if corrective action...is not undertaken..." Section 22a-6k(b) of the CGS authorizes the DEEP to issue temporary authorizations for certain activities regulated under general permits for Tidal (Structures, Dredging and Fill and Minor Activities), and Dam and Reservoirs (Minor Activities). A temporary authorization may be granted when DEEP finds that "...such activity will not continue for more than thirty days..." and that "such authorization is not inconsistent with the federal Water Pollution Control Act, the federal Rivers and Harbors Act, the federal Clean Air Act or the federal Resource Conservation and Recovery Act." "No temporary authorization shall be renewed more than once, and no such authorization shall be issued for an activity which has been authorized by a temporary authorization during the previous twelve months." Such emergency and temporary authorizations shall be limited by any conditions that Commissioner of DEEP deems necessary to adequately protect human health and the environment. Close coordination with the OEP is crucial to ensuring a successfully completed project.

Wide spread Weather Related Repairs - Not Declared an Emergency by the Commissioner

In certain situations, severe weather conditions may cause widespread damage to the Department's transportation systems but not warrant an emergency declaration by the Commissioner. When this scenario occurs, special procedures must be implemented to ensure that no work occurs outside of what the Department is authorized to perform under the General Maintenance Permit. Any work that needs to occur in or adjacent to a regulated area must be coordinate with the District Drainage Engineer prior to being started. Each Maintenance Garage shall have a POC list which dictates who must be contacted in the event that storm related damage is discovered. No work shall be performed until the District Drainage Engineer has been contacted and has approved the repair.

The District Drainage Engineer will be responsible for developing a site list and determining whether the required activities can be covered under the Drainage Maintenance Permit. When the scope of proposed work exceeds the limits set in the Drainage Maintenance Permit than the District Drainage Engineer must coordinate with OEP to obtain the appropriate authorization prior to starting any regulated repair work. OEP will work with DEEP to obtain a blanket temporary authorization to perform storm repairs.

When storm repairs are required, the Drainage Engineer will be responsible for obtaining before and after pictures at each work site, aerial impact quantities for any repair work in a regulated area, and the work start and work completion dates. By no later than thirty (30) days following the storm event the District Drainage Engineer will provide this information to OEP.

Chapter 2 - Construction Surveys

2-201 Survey Parties

The duties and responsibilities of survey crews and the types of construction surveying performed is covered in this chapter. The discussion applies to surveying performed by Department forces or consultant or contractor personnel.

2-201A Responsibilities and Duties of Survey Parties on Construction Projects

Survey parties are assigned to construction projects by and are under the direction of the Principal Engineer-Surveys or authorized representative. Responsibilities include the following activities.

- Setting stakes for lines and grades on all construction and reconstruction projects within the District, when required by the contract.
- Spot-checking layout and staking performed by contractor forces when construction staking is a part of the contract.
- Performing field work and office computations to quantify volumes for partial and final payments, when not performed by the Inspector.
- Staking for fencing or other purposes along property lines, highway lines, or non-access lines (Department forces only).
- Integrating activities with other sections of the unit, through the Principal Engineer-Surveys in the District Office.
- Field checking existing or resetting sufficient control points and bench marks so that contractors can provide their own staking, when called for in the contract.
- Tying in existing street, highway and private property line monumentation as required.

2-201B Responsibilities and Duties of Chief of Party

On construction projects to be staked by the Department, the assigned Chief of Party is responsible to the Chief Inspector while at the construction site. Duties include:

- staking out projects in accordance with the plans,
- establishing and maintaining all necessary controls,
- obtaining measurements and other information,
- submitting reports showing results of work performed, and
- ensuring that sufficient stakes are set to enable the contractor to proceed with regular work to complete the project as scheduled.

Prior to starting any field work, the Chief of Party must thoroughly examine the special provisions of the contract, which are available at all times in the District Office files, and the plans of the project to become thoroughly familiar with the proposed work.

The Chief of Party will, in addition to setting the original stakes, make special measurements, take cross sections, and give line and grade for special work as requested by the Inspector, either directly or through the Field Supervisor-Surveys. The Chief of Party is governed in this work by the plans, special provisions, specifications, original design computations, and any special instructions from the Field Supervisor-Surveys.

If contract documents require construction staking to be done by the contractor, sufficient checks must be made by the State or consultant survey party to determine that the work is done in conformance with the plans, specifications, and special provisions.

Should an error or variations from the contract documents in layout be observed, the Chief of Party must immediately notify the Project Engineer or designated representative. Under no circumstances is the Chief to coordinate the finding with the contractor or consultant without first notifying the Field Supervisor-Surveys.

The Chief of Party will cooperate with the Chief Inspector at all times and acquaint the Inspector with the locations of all points and the extent to which the work is covered by surveys. All dealings with the contractor or the contractor's representatives are through the Chief Inspector.

When the survey party arrives at a construction site and it is determined that insufficient field work is available to accommodate the entire workday, the Chief of Party will call the District Surveys Office for assignments for the remaining portion of that day.

2-201C Assignment of Survey Parties

When surveying is needed on a construction project, the Project Engineer requests a survey party through the Field Supervisor-Surveys. The Principal Engineer-Surveys must keep abreast of all construction survey requirements and meet such requests within the required advance notification period so that all surveying schedules can be met. Survey parties may be requested on shorter notice, if the nature of the work requires it. However, requests of this type should be kept to a minimum.

Construction surveys should be scheduled to provide a full day's work on the project, if practicable. The estimate for the extent of an assignment must consider travel time to and from the project, as well as additional work on the project or other projects nearby. If construction survey work requires only a portion of a day, the Survey Section will arrange for additional location or right-of-way survey work, as near to the construction site as possible, to make use of the remaining time for that day. The coordination of the work is accomplished through communication between sections.

If a request is made for a survey party for construction staking, the request must contain the following information:

- the project number,
- the project location,
- the anticipated length of time the survey party will be needed,
- the nature of the work to be accomplished,
- the Chief Inspector's name,
- the telephone number at the project, if one is available, and
- any other applicable special instructions that affect the type and amount of equipment, material and personnel required to accomplish the assignment.

Immediately upon receipt of plans and a copy of the advertisement for letting of a contract, the Principal Engineer of Survey and Plans prepares a Work Order for construction surveys and incidentals. Upon receipt of the Work Order, assigned field parties perform the work necessary to reestablish the field controls from the plans and preliminary survey notes. The scope of work may vary among projects, depending on the special provisions. The assignments are made well in advance of the start of construction, to allow the Chief of Party time to check all data shown on the plans and to establish controls in the field prior to the start of construction operations.

2-202 Survey Equipment

2-202A Assignment of Field Party Equipment

Field engineering equipment is assigned to the Chief of Party, who is responsible for its care and use. The Chief of Party is also responsible for having complete equipment and sufficient supplies on the project to perform all the work required.

2-202B Use of Equipment

- The Chief of Party is responsible for the maintenance and accuracy of all assigned equipment.
- If an instrument becomes damaged or is in need of repair, the Principal Engineer-Surveys will make arrangements for the necessary repairs.
- A total station must be checked at a calibration range approved by the Department's Office of Central Surveys prior to the start of survey activities.

All equipment is inspected periodically by the Principal Engineer-Surveys. The Chief of Party is responsible for any neglected or abused equipment. Each Chief of Party must submit a complete inventory of all assigned equipment to the Principal Engineer-Surveys, when required.

2-202C Transporting Equipment

Chiefs of Party ordinarily carry all necessary equipment in survey vehicles (vans), so it is available at all times in case it is needed. Extreme care must be exercised in packing equipment in the vehicle so that such articles as level rods, line rods, tripods, and similar items will not be damaged by scratching or rubbing. Instruments must never be transported by placing them on the floor or seat of a vehicle. They are placed in the special compartment in the survey vehicle. If it becomes necessary to transport instruments for long distances, they must be placed in their cases and in additional shipping cases, and further protected from damage by placing them so they will receive the least possible jar and vibration.

2-202D Damage to Equipment

If equipment is damaged or destroyed through carelessness, or through inexcusable or avoidable accident, the employee responsible will be charged with the cost of making the necessary repairs. Damage to equipment, whether caused by accident or carelessness, must be reported immediately through the immediate supervisor to the head of the Division. Damage to State equipment or property that does not involve outside parties or personal injuries is reported on Form PRO-57.

2-203 Safety and Traffic Control

- Safety vests, hard hats, and foot protection are worn by all employees working in the field.
- The Chief of Party is responsible for setting and maintaining work area signs and signing patterns required for surveying operations. Refer to the *Manual on Uniform Traffic Control Devices* (MUTCD) flagging and signing requirements.
- Flaggers must be used to control traffic and protect survey personnel.

- Flaggers should be stationed in advance of the work. They should face the oncoming traffic and perform their duty diligently while the work is being performed. They should move to the side of the road whenever the crew and equipment temporarily move off the roadway area.
- Members of the survey party serving as flaggers are required to use safety paddles to signal and control traffic. See Chapter Eleven, “Construction Traffic,” for signaling methods.

NOTE: The setting of complex or long traffic patterns is usually performed by the contractor or Maintenance Department.

2-204 Note Keeping

2-204A Standard Note Keeping

All survey notes are recorded in standard Department field notebooks or electronic data collector files. Inscribe the name of the town or towns, the route number, and the name of the project on the top half of the outside front cover of the field book. Assign a number to each field book. The number consists of three parts: the number of the town, the serial number of the project in that town, and a letter of the alphabet. The first book used will have the suffix “A,” the second will have the suffix “B,” etc. On extremely large projects if more than 26 field books are used, the 27th book is numbered “AA,” the 28th is numbered “AB,” etc. Place the number on the front cover in the space provided and on the bound edge, using drawing ink.

The book title reference describes the material in the book, such as general information, level notes, borrow bank cross sections, embankment cross sections, or final measurements. The project number, book number, book title and volume coding is also placed on the flyleaf with a brief description of the notes contained in the book, such as the “I-84 —Towns of Manchester and Vernon—Construction Survey, Final Measurements.” The first ruled half sheet of the book is used to index the contents of the book.

If more than two field books are required for a project, each book should be indexed. In addition, a separate index book should be kept covering all information contained in the various books, by book number and page. In each notebook the right-hand page of the first full sheet is designated “Number 1,” and the double pages that follow it are numbered sequentially in the upper right-hand corner of the right-hand page of the book. Numbers always refer to the double page. Show the starting date of the survey on page 1. Each day that work is performed, show the date and the names and duties of each member of the survey party. The duties of party members are shown by the use of standard symbols.

2-204B Care of Notebooks

Survey notebooks and electronic data collector files (hard copy download) are original records, and the greatest care should be exercised to prevent loss or damage to notebooks and files. If possible, they should be kept in a fireproof case or a vault. Each Chief of Party or other person using a notebook or computer file is charged with its safe custody and is responsible for returning it in good condition to the immediate supervisor. Do not leave field books in the field offices of the Inspector or contractor at any time. It is never permissible to remove pages from a notebook for any reason. If the notes are obsolete or void, mark each page with crossed diagonal lines. Place the markings so that they do not obliterate any part of the notes. Add a reference for the correct book and page.

2-204C Survey Notes

For consistency and ease of use, all notes for construction surveys must follow the standard note keeping format. All data collection files will follow the format of its software. The data files accurately and completely record the work done and the information gained during the survey, so that any qualified

Department instrument operator, draftsman, or engineer can immediately interpret their meaning. Chiefs of Party and other note keepers should strive to become proficient in keeping data according to the established standards.

Incomplete and illegible notes will not be tolerated. Notes are kept with a sharp, hard pencil of a degree of hardness warranted by the hardness and smoothness of the notebook paper. Ordinarily a 3H or 4H pencil should be used. In some cases, when paper is lightly damp, it may be necessary to use an H or 2H pencil. Never erase in a notebook. If a figure is recorded incorrectly, or if an error in computation is made, the incorrect figure should be crossed out in such a manner that it is still clearly distinguishable, and the correct figure should be written above. All sketching should be done with a proper note-keeper's tool. Freehand sketching should seldom if ever be used. All notes should be lettered. Clear, legible lettering of the type accepted as engineering lettering should always be used. As stated above, the first page of notes in the notebook must show a brief title of the day's work, the date, and the names and duties of the members of the party. For each successive day's work, if it is a continuation of the past day's task, the page need not be titled again. The date and names and duties of the party members is sufficient. The end of each day's work must be noted.

Field data should always be originals. If, because of weather or other conditions, it is not possible to keep clean, legible notes, note keeping should be discontinued until conditions are favorable. Never keep notes on a loose piece of paper to be later copied into the notebook. If it should be necessary to make copies of field notes, the copy must be distinctly marked to indicate the fact. When it becomes necessary to continue notes from one book to another, the books should be cross referenced. Place the number of the previous book on the first page of the book where the notes are continued, and place the number of the book where the notes are continued on the last page of the previous book.

When field data is collected electronically, a field book shall also be used. The field book shall still report the daily activities, survey party numbers and their duties. When collecting survey data electronically, it is imperative for accurate sketches of work locations and controls to be available for future reference.

2-204D Notes for Bench Levels

Three-wire leveling is normally used for control or shots where a high degree of accuracy is warranted. The single-wire method is used for all other control or shots. Trigonometric leveling can be substituted for either of the above methods if proper procedures are used. (See Location Survey Manual)

The left-hand page is used to record rod readings and elevations, and the right-hand page is used for the identification of bench marks, turning points, and other elevations taken during the survey. The location of any bench marks established must be described with sufficient accuracy so that they may be readily found for later work or by other parties. The bench mark must be clearly described and referenced to prominent witnesses. When the witnesses have not been located in the survey, the bench marks shall be referenced to stationing on the preliminary traverse line so that they can be easily located.

The following guidelines apply where new bench marks must be established on construction surveys.

- The distance between permanent bench marks should not exceed 800 ft. (250 m).
- The maximum difference in elevation between bench marks is 50 ft. (15 m).
- The bench mark should be located outside of the construction area.

- If suitable objects for bench marks do not exist, monuments or other rigid, permanent points must be set. These may consist of railroad spikes or other substantial objects driven into the root or base of a non-ornamental tree in excess of 12". Objects driven into utility poles are not acceptable as bench marks. (See Location Survey Manual for further detail.)

The elevation of newly established bench marks must be determined by using the bench mark as a turning point between existing bench marks.

2-204E Cross Section Note Guidelines

Follow these guidelines when taking cross sections manually in a field book.

- Write legibly. Do not make extremely small figures.
- Do not crowd notes. Allow ample room for the reduction of rod readings.
- The right-hand page is used only for Quantity Cross Sections.
- Other shots or sections that are taken for information purposes, not for quantity documentation, are kept on the left-hand page. These include skew sections, culvert sections, and short odd sections such as for driveways or profiles.
- If a section or a portion of a section is used as a back section and a portion or entire section is used as an ahead section, record the required information as two separate sections with a station differential of at least 0.03 ft. (0.01 m). This condition may occur at a bridge abutment if one section is needed to show the roadway and another to show the ground at the base of the abutment.
- The computer is not programmed to accept more than one elevation at a given point, such as occurs at curbs, retaining walls, and banks. In such instances, change the second distance so that it is longer by 0.03 ft. (0.01 m.) from the first
- Bench levels used to establish the H.I. (height of instrument) are shown on the left-hand page each time an H.I. is changed.
- The entire H.I. is shown on the bottom of each right-hand page. If the H.I. changes on the page, draw a dividing line across the page between the sections dividing the H.I.s and write the new H.I. just above the dividing line.

In summary:

- Keep the notes clear, neat and understandable.
- Record all data to be used for earthwork computations on the right-hand pages and all other data on the left-hand pages.
- Place any special explanatory notes necessary on the right-hand page and label them for the computer operator's attention by circling the item to make it conspicuous.

2-204F Cross Section Notes (Level and Rods)

Cross section notes, if levels and rods are used, are recorded using the guidelines below.

- The right-hand page is used only for cross sections to determine pay quantities.
- The bench levels used to establish the H.I. are shown on the left-hand page each time an H.I. is changed.
- Any rod readings or sections taken for informational purposes, rather than for quantity determination (skew sections, culvert sections, short odd sections for driveway profiles, etc.) are kept on the left-hand page.

2-204G Notes for Bridge Staking

All bridge staking notes are carefully recorded. Sufficient stakes are set and their exact position recorded so that any of the control lines can be replaced with a minimum of effort. If batter boards are set, stakes must also be placed so that the batter boards can be easily replaced or checked if they are destroyed or accidentally knocked out of position.

2-204H Notes for Construction Stakes

Notes for construction stakes are recorded as follows. On the left-hand page, record the stations and pluses, offsets, the elevations of the stakes, grades, stake markings, banks, and slope distance for the left side of the road. On the right-hand page, record the horizontal distance for the right side plus the offset, stake elevations, grades, stake marking, banks, and slope distance for the right side of the road.

2-205 Computations

All ordinary computations made for survey-type work, are made on standard 8½ in. × 11 in. (216 mm × 279 mm) or 11 in. × 17 in. (279 mm × 432 mm) computation sheets (Form DES-3A). Place the name of the project, the Work Order number, the signature of the computer, the organization unit number, the date and the purpose of the work in the designated position on the sheet before any work is done. The checker signs the sheet in the proper place after the computations are completed and correct. The sheets become part of the permanent records for the project and must be bound and kept in a fireproof place.

2-205A Completeness of Computations

Computations must be complete in every respect so that they can be checked readily by engineers not familiar with the project and so that their meaning will be clear at later dates when the details of the work have been forgotten. The steps in the computations must be explained, and all deviations from standard procedures must be carefully noted. Computations must be continued to a logical conclusion, and the results must be stated concisely.

2-205B Revisions to Computations

Preliminary computations that have been revised or recomputed shall be marked “obsolete” in red pencil but must remain a part of the file. No computations shall be destroyed without the express consent of the Principal Engineer—Surveys. Erasures are never permitted on computation sheets. If a change is required, the portion to be revised is struck out with a single line, and the new figure is placed above.

2-206 Staking**2-206A Staking Centerline**

When construction staking is to be performed by the Department, the Project Engineer must notify the Field Supervisor-Surveys well in advance of the time the contractor wishes to commence construction operations. The contractor's starting date is a guide for scheduling the staking.

The Chief of Party stakes the centerline of the proposed road as indicated below.

- Stakes are set every 50 ft. (20 m) on the line.
- Centerline is indicated on the stakes by the use of tacks or marks to the nearest 0.01 ft. (3 mm) of true line and true distance. Other means of identifying the points may be used if the preservation of the points is not required.
- All stations are set using horizontal distances.
- On long tangents and curves, it is advisable to set tacked hubs every 50 ft. (20 m) or less, so that offset stakes may later be tacked to provide a means of resetting stakes accurately without excessively long runs to the control points. The tacked offset stakes should be tied to at least two durable references so that points can readily be replaced if destroyed during construction.
- Curves are staked from the data on the plans.
- Additional stakes are placed at curves if advisable to stake super-elevation and widening.
- If construction staking is performed by the contractor, the Chief of Party reviews the staking to ensure that sufficient control points are established and referenced so that they will be readily available during the life of the project.
- Stakes are set at each station. The first substation after Station 10 + 00 is 10 + 50.
- Offset stakes with tacks are set on both sides of the proposed road, opposite each centerline point established during the staking of the line. Stakes 2 in. × 2 in. (45 mm x 45 mm), approximately 18 in. (450 mm) long, are driven about 12 in. (300 mm) into the ground at convenient points well outside the area that is likely to be disturbed during construction operations. Great care must be taken to place these stakes at right angles with the tangents and on radius lines for curves. Longer stakes are used in soft ground to ensure that they are firmly set.
- The horizontal distance from the tack to the centerline must be legibly marked in yards to the nearest inch on the back of the stake (the side away from the centerline). Mark the station number and plus on the side of the stake toward the beginning station. Mark the cut or fill on the front of the stake (the side toward the centerline), showing the vertical distance in yards and inches from the top of the stake to the finished pavement surface at the centerline. Stakes below these points are marked with an "F" to indicate fill, and those above the centerline elevation are marked with a "C" to indicate cut. The notes must show the exact position of each stake and the information recorded on it. Such information as super-elevation and widening of curves is placed on the other side of the stake (opposite the station). Figure 2-2.1 shows the method for marking the four sides of an offset stake.

- All bench marks must be checked into when the levels are run to set the cuts and fills for the offset stakes. To avoid a blunder, close to a different bench than the one started from.

See Figure 2-2.2 for recommended stake standards.

Figure 2-2.1 Typical Offset Stake Markings

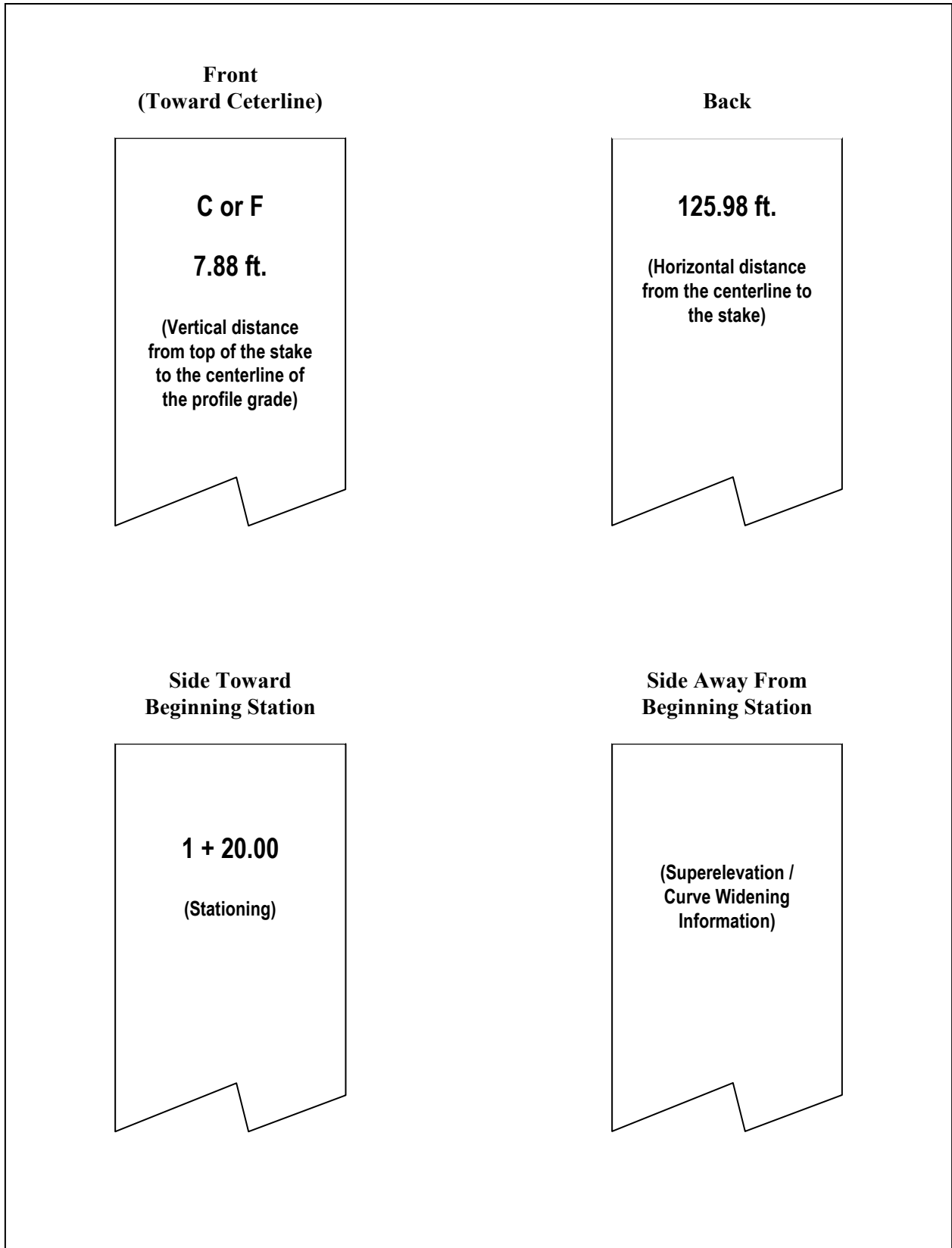

Figure 2-2.2 Recommended Stake Standards

	Stake Type	Horiz. Tolerance	Vert. Tolerance	Max. Spacing	Stake Notation		
					Front	Back	Left
Clearing Limits	3	1 ft.	n/a	100 ft.	Clearing limit		
Rough Grade (2) (4)	3	0.1 ft.	0.1 ft.	100 ft.	c/f	o/s	station
Fine Grade (1) (2) (4)	1	0.1 ft.	0.01 ft.	50 ft.	c/f	o/s	station
Centerline	1	0.1 ft.	n/a	50 ft.			station
Slope (2) (3)	1	0.1 ft.	0.1 ft.	50 ft.	o/s to intercept c/f total horiz. slope distance rate of slope distance	station	
Blue Tops (1) (2)	2	0.1 ft.	0.01 ft.	50 ft.	c/f	o/s < 5 ft.	station
Curb & Gutter (1) (2) (5)	2	0.01 ft.	0.01 ft.	5 ft.	o/s, c/f		
Pipe (6) (2)	4	0.01 ft.	0.01 ft.	100 ft.	c/f	o/s	station
Boundary	4	0.01 ft.	n/a	n/a			
Minor Structure (7) (2)	4	0.01 ft.	0.01 ft.	n/a	o/s	c/f	structure ID
<p>Stake Types</p> <ol style="list-style-type: none"> 3/4" x 2" x 18" 2" x 2" x 12" or nails or stakes 3/4" x 2" x various 2" x 2" x 18" with tack, or 6" – 8" spike <p>Notes</p> <ol style="list-style-type: none"> Stakes placed on grade shall have an "X" marked on top of the stake and the word "Grade" written instead of "C" or "F." Elevations are measured to the top of the stake. Slope stakes should be set at a minimum of 10 ft. offset from the slope intercept. If the grade is less than 1 percent, the minimum stake spacing should be reduced. Grade is the top of curb; offset is the back of curb. All pipelines require at least two reference lines of 2 hubs, spaced 15 ft. apart. Reference lines are to center of junction box, drop inlet, CLCB, front face of headwall, or center gutterline CCB. <p>Stake standards adapted from <i>Manual on Construction Layout</i>, National Society of Professional Surveyors, 1993</p>							

2-207 Cross Sections

2-207A Earthwork

It is essential that accurate cross sections of the proposed improvements be available for determination of final pay quantities. The preliminary survey elevations, as plotted on the project's section sheets or taken from the computerized location survey surface, should be checked against the ground elevations recorded just prior to construction.

If there has been any change in the contour of the ground surface, new cross sections must be taken before construction starts. One example of the need to check the original cross sections is when they were taken when deep snow covered the ground with possible ice formation or frost heaves. If the original cross sections taken during the preliminary survey still show the true conditions, they may be used without further work. The checks of the original ground elevation should be made after the centerline or base line of each roadway is established and the offset stakes are placed, so that the sections can be checked at the correct angles with the centerline. It is recommended that ground elevation checks also be made along the slope limits. Particular attention should be given to areas where ground elevations vary considerably. All ground elevation checks should be recorded in a field book or electronic data-collector file and retained as part of the project records.

Cross sections are taken every 66 ft. (20 m) and at points between them where there is a break of grade or a change in the shape of road or embankment. The elevations of all breaks in grade on the cross section lines shall be determined and recorded as specified in the instructions for note keeping. The last reading on each cross section line must be well outside the proposed roadway limits. Sufficient cross sections must be taken in the transition areas between cuts and fills so that quantities can be accurately computed. Cross sections are required where side roads, driveways, or approaches must be constructed or where special structures are to be built. Cross sections are needed at culvert locations. If these cross sections were not taken during the preliminary survey or are insufficient for computing pay quantities, additional cross sections should be taken before construction commences.

Electronic data collectors can be used to process TIN files and create computerized cross sections. Sufficient shots and break lines must be collected to accurately create cross sections at all of the required locations noted in the previous paragraph.

2-207B Rock Excavation

When rock surface has been exposed and before rock excavation has begun, the survey party is called to the project to take cross sections manually or through electronic data collection for the determination of quantities. Careful cross sections of the rock shall be made on the same cross-section lines as the original sections and such intermediate lines as are necessary to determine accurately the quantity of the rock to be excavated. Cross sections are taken at intervals of not more than 33 ft. (10 m), unless the facial contour of the rock shows that additional sections are needed. If the excavation is bid by the contractor at the same unit price for rock and earth, sufficient data shall be kept to permit a reasonable estimate of the quantity of each.

2-207C Unsuitable Material

If unsuitable material or loam is encountered in the roadway, the survey party will take cross sections, both before and after excavation work, to determine the pay quantity.

2-207D Borrow Banks

The Project Engineer must notify the Principal Engineer-Surveys at least five days prior to obtaining material from borrow pits. All pits shall be cleared by the contractor prior to calling a survey party to the project. The Chief Inspector will show the Chief of Party the limits of the proposed borrow pits. Base lines are laid out well beyond the limits of the pit, and control points are tied in. Bearings are taken on base lines and angles are turned to tie points, so that they can be reestablished at any time. At least two bench marks must be established at each borrow bank. Bench marks must be placed beyond the limits of the area to be excavated.

Cross sections are taken at 66 ft. (20 m) intervals, with sufficient intermediate sections taken to show the true contour of the ground. It is the District's duty to take its own borrow-bank cross sections and make its own computation of quantities removed from borrows banks, completely independent from the contractor's computations. However, contractors may request to check borrow-bank measurements. This can be accomplished by supplying them with the base-line data so that the cross sections will be related to the same base line. The data supplied to the contractor should be limited to base-line ties, stakes, and bench marks.

If the contractor has completed work, final sections are taken over the area excavated. The original base line must be reestablished so that cross sections can be taken in the same locations as those of the original sections, with intermediate sections taken as required to obtain accurate quantities.

The Chief of Party informs the Chief Inspector of the limits covered by the pit survey, and the Chief Inspector notifies the contractor that additional cross sections are required before the contractor excavates beyond existing surveyed limits.

Electronic data collectors can be used to process TIN files to create surfaces for surface-to-surface volume or cross sections. Sufficient shots and break lines must be collected to accurately create cross sections at all of the required locations mentioned above.

2-207E Stakes for Concrete and Other High Type Pavements

A second set of construction stakes is set if concrete and other high type pavements, curbs, or headers are to be constructed. One set of stakes is ordinarily sufficient for other work. These stakes are uniformly offset 2 to 4 ft. (600 to 1200 mm) outside of the edge of the pavement or the back of the curb or header. Stakes for curbs are marked to indicate the cut or fill to the top of the curb rather than the finished centerline elevation.

Stakes for concrete pavement are marked with the amount of cut or fill from the highest point on the top of the stake to the elevation at the edge of the finished pavement surface. The position of the stake and the information recorded on it must be shown in the notes. The cut or fill is given in feet and hundreds (0.01 ft.)

2-207F Staking Bridge Structures

The centerline is determined for bridges by running the line between points of curvature and tangency of curves or between other established points so that the true centerline may be staked. The stationing must be carried from one known station and checked into at least one other station on the opposite side of the structure. The structure is located as shown on the plans, unless instructions to the contrary are received from the Project Engineer. The establishment of the centerline and the stationing of the structure must be checked in sufficient detail to make absolutely sure of its correct location.

The centerline of the roadway is carefully monumented by driving hubs at each side of the structure, well outside of the construction area, and parallel lines are run and monumented at even distances from the faces of the abutments. If possible, backsights are set on the lines so that the centerline and parallel lines can be reestablished, even if the foresights are blocked by material piles or embankments. The hubs are set and

referenced to witnesses that are not likely to be disturbed during construction work. If this method is impractical, batter boards, with nails to mark the exact line, are placed at approximately equal distances from the centerline of the roadway on the lines of the faces of the abutments.

Batter boards are set at the elevation of the bridge seat if practical, and each batter board is marked to indicate the line and elevation represented. If the face of the abutment is battered, the line of the top of the abutment is staked. If the centerline stakes are likely to be disturbed, offset stakes on the line of the face of the abutments are placed and carefully referenced. Separate lines are staked to establish the lines of the faces of wing walls, the lines of the parapets, faces of the haunches, and any special lines of control that are required. Considerable work and time may be saved by setting targets as well as hubs on the reference lines, the targets being set with sufficient stability to remain in place during the entire construction period. One or more bench marks are set at convenient points at the site. The locations of all stakes must be shown on a carefully drawn sketch in the notes. On large structures, two bench marks are established near the bridge site, one on each end of the bridge. When elevations are set for a structure, a check run must always be made back to a bench mark.

On large bridges where more accurate surveys are needed, additional care and measurements must be made to ensure the absolute integrity of the bridge layouts. To aid the Inspector in checking the details for construction of larger bridge structures, it is recommended that the more important control points, such as centerline of bearing and the base line station at centerline of bearing, be established on the structure as soon as the footing is completed. This will facilitate an accurate alignment and position check of the form panels as they are placed. Drill holes or concrete nails work well as point markers. If the elevations of these control points are accurately established, the inspectors will have a convenient datum to work from when checking form details.

Prior to starting a bridge in the field, the footing plan should be laid out to scale on paper, and the excavation payment line drawn on the plan. The Chief of Party uses this plan, which shows the location at each angle point and each change in width, to take the cross sections at the proper points. After the bridge is staked on the ground, the Chief of Party takes cross sections for bridge excavation. Sections are taken at each break in the payment line noted on the plan, as stated above, as well as at the breaks in the ground. The sections must cover any work required to widen or relocate the channel of a wet crossing.

2-207G Staking Special Structures

The staking of special structures is done well ahead of actual grading operations so that the contractor can do such work as building culverts, drains, sewers, and the line structures as early as possible to permit adequate settlement of the backfill. Ordinarily the inspector will be able to set construction stakes for culverts. The invert lines and grades for sewers, drains, large culverts, and other special structures are staked by the survey party on offset lines as agreed with the contractor. The stakes are set so that there is minimum of interference during the construction work.

2-208 Replacing Stakes

If stakes become lost, broken, or displaced, they are reset by the survey party that set them – the Department, consultant or contractor. If stakes that are set by Department forces are damaged, the Chief Inspector advises the Field Supervisor-Surveys or, if necessary, the Chief of Party in sufficient time so that the stakes can be replaced without delaying the construction work.

2-209 Measurements for Monthly Estimates

The survey party makes measurements of work, completed or in progress, needed by the Chief Inspector to prepare monthly estimates.

2-210 Final Survey

Checks on the contractor's ability to conform to the lines and grades given should be made during the course of the work by the appropriate inspector or survey party. Any deviations found should be brought to the contractor's attention, through the Chief Inspector, so that corrections can be made as the work progresses. The more nearly the final project conforms to the original design the easier it will be to prepare the final quantities.

In general, any project or section of project that has been constructed in accordance with the designed plan will not require final cross sections. All ordered changes in line, grade or slope lines will have to be measured and the amount of the change added to or deducted from the original quantities. These changes should also be shown on the final plans and/or cross sections so that they are readily visible. Miscellaneous excavation for items such as driveways, drainage structures, and ramp approaches that are not covered by the original sections must be measured for payment. No cross sections will be required on pavements that have been constructed in conformance with "fine grades" established by the Engineer specifically to control pavement line and grade. The Inspector is responsible for ensuring that the pavement is built to these grades.

Rock sections are required at the time the rock is uncovered as well as when final measurements are taken. On surplus excavation projects, it is not necessary to cross section the slopes of any fill. Slope stakes and occasional checks are sufficient to assure that the slopes are not appreciably less than designed.

On borrow projects, the amount of excess material placed outside the slope lines must be deducted from the borrow measurement. If the slopes are fairly uniform, taking a cross section to check the typical section is sufficient to determine whether the fill is constructed reasonably close to the design. If it is found that there are deviations that should be deducted from "Borrow," additional sections should be taken to accurately measure the deduction. Areas where the additional fill was directed by the Engineer, and therefore should not be deducted, do not require additional cross sectioning.

Chapter 3 - Excavation and Embankment

2-300 General

2-300A Introduction

The general term “earthwork” encompasses the initial construction operations on a highway project. These operations include staking slopes; clearing and grubbing the natural ground; excavating earth, rock, and other materials; building embankments; disposing of unsuitable and excess materials; compacting in-place materials to proper density; and installing temporary pollution controls.

This work is to be accomplished as indicated on the plans, in accordance with the current *Standard Specifications* or special provisions, and as designated by the Engineer.

2-300B Definitions

Various terms are used in the chapter to designate areas pertinent to a construction project. The terms are defined below.

- *Highway Limits.* The boundaries of the whole right-of-way that is reserved for or secured by the Department for use in constructing the roadway and its appurtenances.
- *Taking Lines.* The highway limits.
- *Roadway Limits.* The limits of construction. These limits may differ from the highway limits, if there are portions of the right-of-way on which construction is not to take place.
- *Clearing Limits.* The boundaries of the area to be cleared and grubbed for the road construction.

Figure 2-3.1 illustrates these terms.

2-301 Setting Slope Stakes

The Inspector must check the slope stakes set by the contractor to establish the grading extremities and to guide the grading work itself. Slope stakes must be set at the top of the slope in cuts and at the toe of slopes in fills, on both sides of the roadway opposite each offset stake. The stakes must be set in accordance with the cross-section template and the construction staking item. Slope stakes may also be used to guide the contractor during clearing and grubbing. Figure 2-3.2, contains additional information about setting slope stakes.

When the slope is designed with a roll at the top and toe, two stakes should be set on each side of the roadway, one to mark the intersection of the normal cut or fill with old ground and the other to determine the limit of the roll.

The Chief Inspector must check frequently as the work progresses to determine that slopes are constructed as designed. The Inspector may be assisted by a survey party in checking the development of the cut or fill if the assistance expedites the check and contributes to its accuracy. However, any assistance given the Inspector by a survey party does not relieve the contractor of responsibility for the proper grading of the entire project.

Figure 2-3.1 Illustration of Lines and Limits

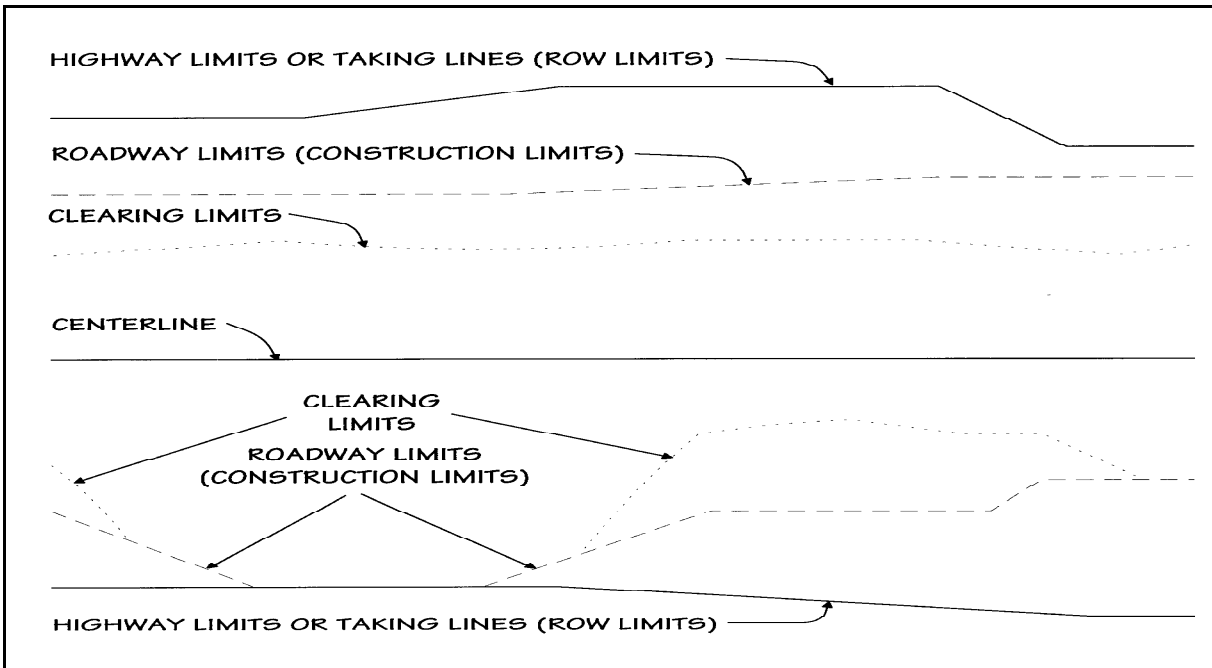

2-302 Clearing and Grubbing

2-302A Description

The clearing and grubbing of a project is usually the first construction operation performed on the job. It entails the removal of trees, stumps, roots, brush, rubbish and all other objectionable materials and objects from within the highway limits and from any adjoining areas designated by the contract. The removal of such objects and materials is necessary for the construction of highways and the installation of structures, drainage features, fences, ditches, and channels. While clearing and grubbing is usually considered one operation and is always considered a single pay item, it technically is two operations:

- *Clearing*, this is removal above natural ground (trees, brush, shrubs, and rubbish).
- *Grubbing*, which is removal below natural ground (roots, stumps, and similar objects).

Clearing and grubbing mainly suggests removing, but it also involves protecting from harm certain vegetation and objects designated to remain.

2-302B Preliminary Activities

A meeting must be held to discuss clearing operations before they begin. Those attending should include project personnel, the designer, local officials, and the District Environmental Coordinator. If clearing concerns are raised, a follow-up field meeting should be held to address the specific concerns before any trees are cut. Accurate minutes of the meetings should be kept.

All trees scheduled to be removed outside the proposed gutter or curb lines must be visibly marked or flagged by the contractor at least seven days prior to cutting the trees. The Engineer must inspect the identified trees within the seven days and check the limits of clearing and grubbing before the contractor

starts the work. Slope limits are to be verified by measurements both in plan and in cross section. If the rights-to-slope have been acquired and the top or toe of slope is outside the highway line by right of a deed easement, the contractor must not clear beyond the slope line.

Figure 2-3.2 Setting Slope Stakes

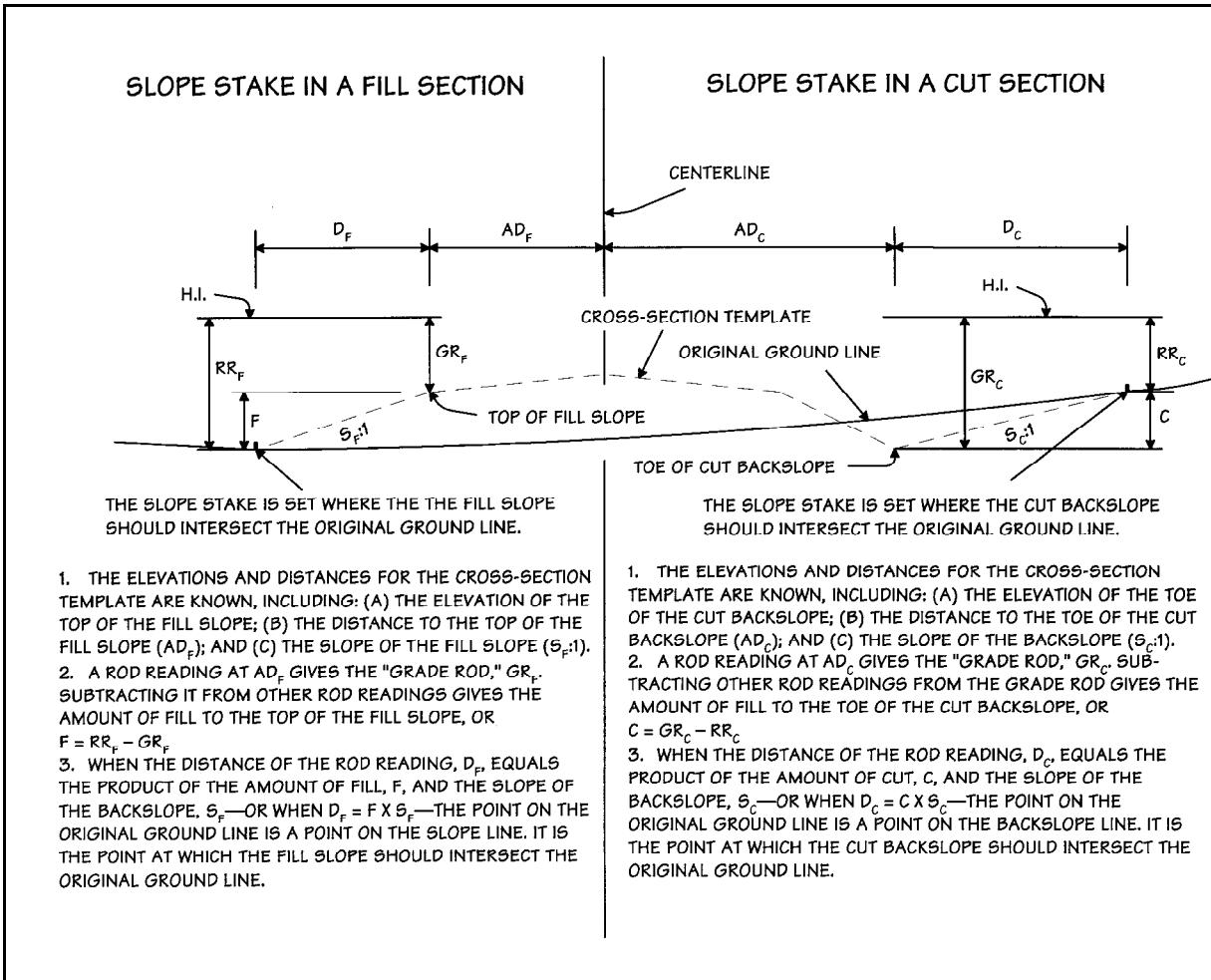

2-302C Tree Removal and Protection

All large trees are to be saved if physically feasible by installing tree wells, modifying slopes, or using other means. Trees may also be designated for preservation because of historic value or other reasons.

If there are questions concerning the soundness or health of trees to remain, assistance should be sought from the District Environmental Coordinator or Office of Design landscape personnel. Obviously, the purpose of this action is to save trees wherever possible and prevent accidental removals. If there is any doubt about whether to remove or preserve trees, they should be preserved, even if there is an increase in cost for removal at a later date.

All tree removals must be reviewed before the work is done to ensure that only those trees that must be removed are removed.

2-302D Disposing of Materials

If the Engineer does not direct otherwise, the contractor should recycle wood, remove rubbish and refuse from within the highway limits, and bury rubble and stone either inside or outside the highway limits.

2-302E Disposal Outside the Highway Limits

If contractors elect to dispose of materials outside the limits of the highway, at one or more points of their choosing, they must first comply with the guidelines below.

- The contractor must ensure that no harm will be done to the project or the environment. Disposal locations must be outside of designated wetlands, watercourses and flood plains, unless otherwise approved by local, State, or Federal agencies.
- The contractor must submit the necessary documentation for review and approval by the Engineer, the Department of Environmental Protection (DEP), or the town's environmental agency. This includes:
 - *Location Plan.* USGS Quad Map, town assessor's map, or town map showing the detailed location(s) of the disposal site(s).
 - *USDA Soils Map.* Area of disposal site(s), obtainable from local town.
 - *Local Permission.* A copy of the local (town or city) approval of disposal site ("fill permit," etc.), including all conditions and the required erosion and sedimentation controls (use of hay bales, silt fence, etc., to ring the site).
- The contractor must obtain permission from the Engineer and a permit from the DEP. To issue a permit, the DEP requires approval by the appropriate local, State, and Federal agencies.

2-302F Disposal Inside the Highway Limits

When contractors request permission for disposal within the highway limits, the work must be done according to the details and requirements shown on the plans, as well as the requirements below.

- Not less than fifteen days prior to disposing of cleared and grubbed materials within project limits, the contractor must submit to the Engineer for approval a written proposal delineating the locations and extent of the proposed disposal areas.
- The proposal must describe the nature of the materials and the methods to be used in placing and covering them.
- The proposal is reviewed for its effects on the completed construction and the environment of the highway.
- The proposal will be amended as required by the Engineer. No materials are to be disposed of within project limits until the proposal has been approved by the Engineer.

2-302G Areas Outside Roadway Limits but Within Highway Taking Lines

To conform to future Departmental roadside development and to minimize future expense, the Chief Inspector must pay particular attention to the area that is outside the roadway limits but within the highway taking lines. In the case of excess property taken during the acquisition of the right-of-way, a uniform distance from the centerline should be established by the District, with the assistance of the Assistant

Director of Rights – of – Way (Boundaries). Within the area, the Inspector must ensure that all stumps are cut flush with the ground, and all dead or uprooted trees, brush, or other objectionable materials are removed and disposed of properly. The Inspector must take special care that no valuable or historic trees are destroyed, unless necessary.

2-303 Survey Markers and Monuments

The contractor is responsible for the protection of all benchmarks or permanent markers or monuments of the State, Federal or local governments; public utilities; or local property owners, including historical markers or areas. The contractor must notify the interested agencies in advance, so that the markers or monuments may be adequately referenced, protected, or reset before being disturbed.

2-304 Excavation and Embankment

2-304A Definitions

Excavation is the removal of soil or rock from its natural location. Embankment is the placement and compaction of layers of earth or rock to form a roadbed of the planned shape, density, and profile grade.

Excavation can be thought of as either roadway excavation or structure excavation. Each of these categories is further divided into several different classifications. Roadway excavation includes:

- earth excavation,
- rock excavation,
- earth channel excavation,
- rock channel excavation,
- unclassified excavation, and
- unsuitable excavation.

The *Standard Specifications* clearly define the classifications and uses them as pay items. The Chief Inspector should be familiar with them. The pay items applicable to a particular project are shown in the proposal form. Inspectors should exercise particular care to see that excavation is classified correctly.

2-304B Earth Excavation

This pay item includes the removal of all materials other than water, ledge rock, large boulders, or loam (if loam excavation appears as a contract item). Included in earth excavation are the:

- Excavation of drainage ditches that are located within the normal cut slope limits. (See *Standard Specifications* 2.06.04-1(a).)
- Removal of stone walls, except stones having a volume large enough to classify them as rock excavation in accordance with the current *Standard Specifications*.
- Removal of other man-made structures, such as old foundations, concrete or masonry walls, crib walls, bin walls, etc.

The quantities of earth excavation for the roadway proper, large quantities at side-road locations, and quantities at most stream locations are computed from cross sections. The plans indicate the locations. The

Inspector must measure and record the volumes of all stone walls removed and any other earth excavation not included in the original cross sections.

Excavation quantities shown on the estimate sheets are estimated quantities. Final quantity determinations are required and should be well documented in the project records. All notes related to final measurement, such as checks of the elevations of existing ground as noted on cross sections or of cross-section areas, should give the date that the work was performed, the name(s) of the personnel performing the work, and the exact limits of the work.

Occasionally, excavation and filling are performed together as an operation, as in the case of benching slopes and removing unsuitable material. The necessary measurements should be obtained as promptly as is practicable. Unnecessary delays to a contractor's operations should be avoided.

A grading plan will occasionally be required by special provision on projects involving borrow, waste, or a large volume of rock.

2-304C Excavation Procedure

Before starting the grading operations, it is common practice for the contractor to set a row of grade stakes to be used for grade lines. The stakes are set at a uniform distance from the centerline of roadway, outside the grading limits, and for a considerable distance along the project.

If the cross sections for a cut show rock slopes or rock-and-earth slopes, the Inspector should pay particular attention to the elevations at which rock is encountered. The Inspector should immediately advise the Project Engineer of any discrepancy that prevents completion of the cut according to the designed cross section or that calls for acquisition of additional property or right – of – way.

Very often earth and other fine material overlies ledge that is to be excavated. Building an embankment from material excavated from this configuration often results in finer material being placed in the bottom of the embankment, while insufficient fines remain to fill the voids in the successive layers of rock fragment placed in the embankment. In other cases, much of the finer material is incorporated in the deeper embankment sections, while the rest of the available excavated material is composed of rock fragments too large to be placed in the remaining shallow embankment section. If practicable, the contractor should arrange excavation schedules so that these situations do not occur, especially on closely balanced jobs. The Chief Inspector should have in mind an overall picture of the grading of the entire project.

As the *Standard Specifications* state, overhaul will not be allowed. Excavated material, including topsoil, must be transported where directed, provided the designated point of deposit is not more than 100 yards (90 meters) beyond the limits of the project contracted for, unless the special provisions or plans state otherwise.

2-305 Rock Excavation

This item includes the removal of rock in definite ledge formation and boulders or portions of boulders one cubic yard (one cubic meter) or more in volume.

2-305A Determining the Quantity To Be Removed

The contractor is required to strip or expose the rock to such an extent that the quantity to be removed can be measured. The Inspector must be satisfied that the ledge is exposed sufficiently to reveal the true

conditions. It should not be necessary for State forces to bar, probe, or trench so that the survey party can take cross sections.

At the request of the Chief Inspector, the survey party must take careful cross sections of the rock. The work should be performed after the rock surface has been exposed but before rock excavation has begun. The cross sections should be taken on the same cross-section lines as the original sections and on the intermediate lines necessary for accurately determining the amount of rock to be excavated.

2-305B Blasting Safety Meeting

When blasting is anticipated, a combined blasting and safety meeting must be held to assure full compliance with safe practices in blasting and all other operations, with emphasis on protection of workers and property. The meeting may be combined with the Preconstruction Conference and/or Utility Conference. The meeting will be chaired by the Project Engineer, and the following persons will be invited to attend:

- District Safety Advisor,
- State Fire Marshal,
- representatives from affected utilities,
- contractor's field superintendent,
- local fire marshal,
- blaster,
- representative of the contractor's insurer, and
- representative of the contractor's supplier of explosives.

Notification of the proposed meeting will be sent by the District.

At this meeting, safe practices in transporting, storing, and using explosives will be discussed. Attention will be given to the pertinent *Connecticut General Statutes*, regulations of the Division of State Police, local ordinances, and *Standard Specifications* of the DOT. The *Specifications* have been developed to protect DOT personnel, owners and residents of adjacent properties, and the motoring public, including school buses and emergency vehicles. The contractor must comply with the pertinent sections of the documents mentioned above. In addition, the contractor must take full advantage of all services available from the insurer and from the manufacturer and supplier of explosives.

The meeting participants must review each rock cut and recommend safety precautions to be taken by the contractor before blasting. The recommendations are made in writing to the contractor, with copies to the committee members and the local fire marshal.

2-305C Presplitting Rock Slopes

Improvements in blasting procedures and the development of the presplitting concept now make it possible to control rock breakage and provide for smooth, stable rock-cut faces conforming to specified slope ratios. The Inspector should review the subsection "Excavation of Rock" under Article 202 of the current *Standard Specifications* to become familiar with this rock-removal technique.

2-306 Blasting Regulations and Good Practices***2-306A Regulations***

The contractor or blasting subcontractor will obtain a permit from the local fire marshal in the town where the blasting is to be done.

All dynamite and cap magazines will be of the approved type and be inspected by the State Fire Marshal's Office.

2-306B Transport and Storage

The transporting of blasting caps in a vehicle containing other explosives is prohibited.

Each vehicle carrying explosives will bear signs on the front, rear, and each side displaying the word "Explosives" in letters not less than 4 in. (100 mm) in height. The lettering will be white. The approved vehicles will be painted bright red.

No explosives or caps will be left overnight on any job unless stored in a magazine.

If no magazine is located on the job, leftover dynamite and caps will be returned to the supplier at the end of the day's work.

All empty explosive cartons will be burned and will not be used for storing drills, tools, stemming, etc.

2-306C Warnings

Before each blast, the contractor will notify the local police department, fire department, fire marshal and, when necessary, any public utility company that may be involved.

The contractor will post signs on all adjacent highways – a minimum of 1000 feet (300 meters) from the blasting site to warn motorists to turn off two-way radios and cellular telephones. The signs will be placed on the road just prior to the loading of the holes and will be taken down immediately after a blast is detonated. The standard sign layout is shown in Figure 2-3.3, on the next page.

The contractor will send out individual workers prior to the detonation to warn occupants of all buildings in the area. This warning will be given prior to the whistle blasts (described below).

The contractor will install a whistle, so that, 15 minutes prior to each detonation, the public will be warned by six 10-second blasts of the whistle. Just prior to the detonation, the whistle will be blown ten short blasts.

The contractor will station flaggers on all highways adjacent to the blasting area to stop traffic before a blast is detonated.

Figure 2-3.3 Signs for Blasting

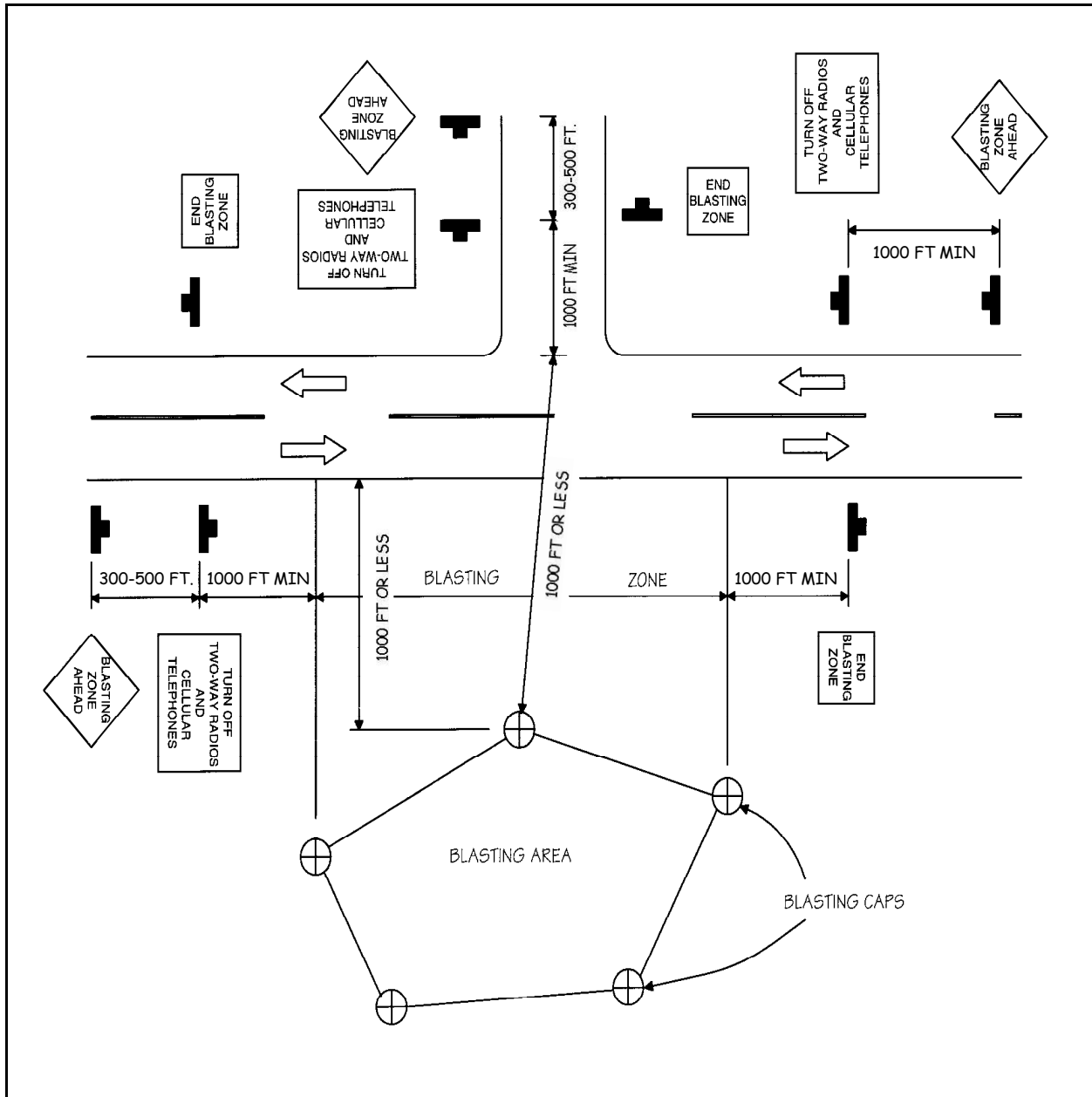

2-306D Special Precautions

Special care will be exercised near broadcasting stations and towers by checking the frequency wave lengths with the stations in question. This is to prevent accidental detonation of wired caps and dynamite by radio transmitters.

In marine construction, proper precautions will be taken to prevent marine transmitting radios from setting off a blast.

In the event of an electrical storm, after loading has started, all operations will cease and the area will be cleared. Whenever possible, the load should be fired before the storm arrives.

Presplit holes should be checked visually along the face for missing patterns that may indicate misfired holes.

In the event of a misfire, all operations in the area will stop and the contractor will notify the Chief Inspector.

2-306E Normal Operations

- All trench or boulder blasts will be covered with a mat constructed to prevent fragments from being thrown.
- For electrically fired shots, the lead wires will be kept short-circuited until the time for firing.
- When testing circuits to charge holes, blasters will only use a blasting galvanometer designed for this purpose.
- No loading operation will be conducted within 25 feet (7.5 meters) of a drilling operation.
- A constant guard will be kept over loaded charges until the blast is fired.
- After each blast an attempt will be made to recover all wires.

2-306F Recordkeeping

The contractor's blasting supervisors will keep a permanent record of all blasting operations in a bound notebook (not loose leaf).

The records will include the following: date, location, time of blast, number of holes, diameter, depth and spacing of holes, pounds and type of explosive used, number of delay fuses, results of blast, and precautions taken.

2-306G Operations

None of the preceding regulations or practices relieves the contractor of responsibility for protecting the public and property, even though specific protective measures may not be mentioned in the report of the blasting meeting. The contractor should be advised of this responsibility.

DOT employees should not influence the contractor's method of drilling and loading, unless the drilling methods are specified in the contract, because it is the contractor's responsibility. However, it may be necessary, as stated above, to ask the contractor to obtain the advice of the explosives company. A representative of the Department of Transportation, usually the Chief Inspector, will see that the recommendations are followed.

Department personnel or representatives will cooperate with the State Police in regard to all blasting operations. All DOT personnel are responsible for seeing that the provisions of the specifications regarding the use of explosives are enforced.

During the progress of the work, any condition found by the contractor or DOT personnel that represent a change from the conditions anticipated at the original blasting meeting will be pointed out to the Chief Inspector.

To excavate to the bottom of a rock cut, it is necessary to extend the drill below the proposed excavation elevation. The extent of this additional depth is up to the contractor. The Inspector must ensure that no rock ledge protrudes above the required excavation elevation, and must have the contractor remove any overhanging ledge and loose or unstable rock fragments from the slopes, even if they are outside the pay lines.

If the contractor's operations appear to cause excessive “back-breakage” – fracturing the rock beyond the intended limits – the Inspector should alert the Assistant District Engineer. A conference may be needed to determine if other methods of blasting are warranted.

2-306H Payment

In accordance with the current Standard Specifications, all boulders must be measured and recorded separately by the Inspector as they are encountered, in cubic feet (meters) and decimals. The Inspector must also designate whether the boulders recorded are in section or out of section, the date of removal, and the location from which the boulders are removed. Boulders that are out of section are those lying on top of the ground or situated so that they are not included in the volume computed from the regular cross section. Out-of-section boulders are not deducted from the earth excavation.

Payment lines for rock excavation, where presplitting bedrock is required by the specifications, will extend to the slope and depth line shown on the plans or as directed, to include only the rock actually removed within this limit.

Where removal of rock is necessary for safety, or due to conditions clearly not attributable to the contractor's methods of operation, the payment lines for rock excavation where presplitting is required will be fixed to coincide with limits ordered by the Engineer.

2-307 Surplus and Unsuitable Material

Excavated material is used to build the project's embankments. If more material is excavated than needed for the embankments, the extra material is termed “surplus.” Material that is unfit for embankment construction is termed “unsuitable.” The disposal of surplus and unsuitable materials is governed by Standard Specifications 2.02.03-8 and 2.02.03-10, respectively.

2-308 Surplus Material

Earthwork that calls for more cutting than filling produces a surplus of excavated material. The excess material may consist of both suitable and unsuitable embankment material. The Project Engineer will indicate where the contractor is to place it. For example, surplus material may be used to widen embankments, to flatten slopes, to fill in low places in the right-of-way, or for other purposes. The only provision is that the area designated by the Engineer for depositing the surplus material does not conflict with the *Standard Specifications* governing placement of excavated material (2.02.03-5). Any surplus or unsuitable material that is not required or permitted to be used for such purposes must be disposed of in accordance with Article 2.02.03-10 of the Specifications.

2-309 Unsuitable Material

2-309A General

Some material encountered during excavation is not suitable for placement in embankments. It usually is located below the surface of the original ground and has not been disturbed. The material typically is high in clay or organic content and would not be stable if placed as fill. However, loam or topsoil usually is classified as unsuitable, even though it is found on the surface. There is no hard-and-fast rule that classifies a material as suitable or unsuitable. A useful guide is to ask the following questions about the material under consideration.

- Is it wet?
- Does it retain moisture?
- Does it have organic material in it?
- Is it compactable? When equipment drives over it, is it compacted rather than displaced?

For unsuitable material, the answers to the questions next to the first three bullets probably would be “yes,” and the answers to the questions by the last bullet probably would be “no.”

The disposition of unsuitable material is generally determined during the design stage of the project, and the manner of treatment is indicated in the plans or special provisions. If material of questionable quality has to be removed from locations not specified on the plans, samples should be submitted to the Division of Soils and Foundations for analysis and classification. A field meeting should be arranged with DOT Soil representatives to review unsuitable material. All recommendations should be documented.

2-309B Topsoil

The locations of topsoil areas should be determined well in advance of the work. Approximate locations are usually given in the computations, in the field review reports, and in the plans (primarily on the estimate sheets). The areas from which topsoil is removed can be either cut or fill areas. In-place samples of the material should be submitted to the Laboratory for approval as topsoil as far in advance of the work as is practical. Preliminary approval or rejection of the material will enable the Department to properly determine the disposition of the material.

When topsoil excavation is ordered from either cut or fill sections, the Inspector must see that it is stockpiled along the outside of the roadway limits, but within the highway limits, and placed where it will be readily accessible to the Division of Maintenance for use as required. The Inspector must contact the District Maintenance Manager to determine the most favorable location for these stockpiles with regard to future work.

A check of proposed fencing in the stockpile areas is important. Should it appear that there will not be sufficient area to stockpile the excavated topsoil; the Project Engineer should be notified so that other stockpile areas can be located.

All topsoil excavated and stockpiled must be free of boulders, roots, stumps, etc., but the contractor is not required to screen the material. Because topsoil depths vary, its removal should be closely watched to ensure that unsuitable material (unsuitable for topsoil) is not excavated and incorporated in the stockpiles.

Topsoil quantities are directly related to the cut and fill quantity columns on the estimate sheets in the plans. On borrow projects, changes in the quantity of excavated topsoil will affect the borrow volume. Regardless of the applicable item under which topsoil is stripped from the roadway area and stockpiled for

future use, original and final cross sections of the excavation areas must be taken before any further grading operations are begun. The stockpiles will be available for measurement. However, a material shrinkage of 20 to 30 percent will probably occur, depending on the equipment used. The measurements of the piles will not give an accurate quantity unless a proper adjustment is made for shrinkage.

2-309C Use or Disposal of Material

“Unsuitable” does not mean “waste.” Every consideration should be given to using unsuitable material, especially on borrow projects. Generally, it can be used to advantage:

- In berms.
- On slopes, generally between specified lines. For example, between 2:1 and 1.5:1 or 1:1 slope lines.
- To widen embankments.
- To flatten slopes. Caution should be taken to avoid preventing water from bleeding through slopes. If water cannot bleed out it will create problems with embankment building.
- To fill low spots within the right-of-way.

Figure 2-3.4 Disposal of Unsuitable Material

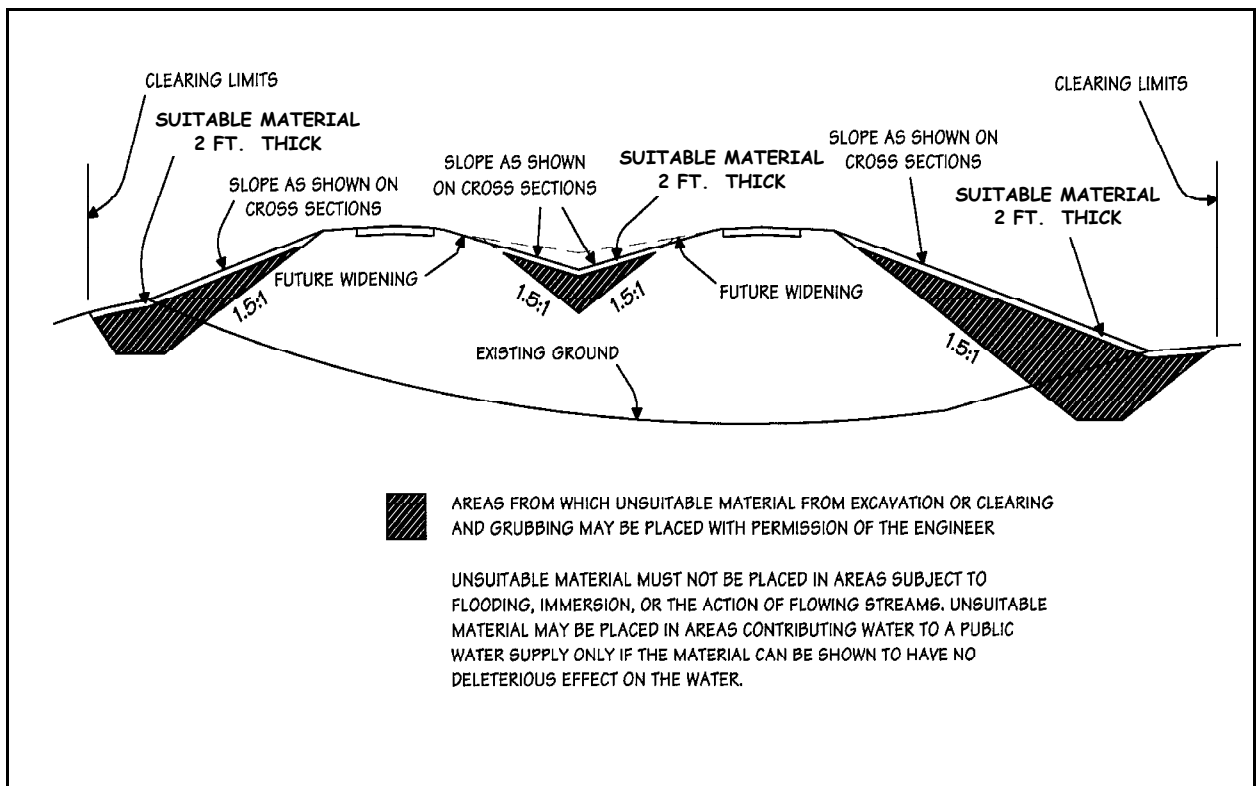

Figure 2-3.4 indicates some of the places for disposing of unsuitable material within the clearing limits.

When the material is not required or permitted to be used for such purposes, the Project Engineer will order that it be removed and disposed of outside the limits of the highway, at locations determined by the contractor. The Engineer must approve of the disposal sites, which must in no way be detrimental to the project or the environment.

The Inspector must know where surplus or unsuitable material removed from the project is disposed of and verify that the disposal is not in an environmentally sensitive area or in a location that is detrimental to the project. The Inspector must be specific when instructing the contractor regarding removal of such unsuitable material and must record the location, depth, and quantity ordered wasted in their notebook. Should the contractor elect to waste any material that has not been judged unsuitable – including boulders or large fragments – the Inspector must inform the contractor by memorandum that such material is to be replaced at no expense to the State. An accurate record of all such removals must be made in the notebook.

2-310 Salvageable Material

Chief Inspectors must be responsible for the contractors' removal and preservation of all designated salvageable material on the project. They should carefully review Article 1.04.07 of the *Standard Specifications*, titled “Rights In and Use of Materials Found on the Work.” In addition, they should contact DOT Stores at the start of each project to review the items that are to be salvaged.

2-311 State’s Property

The Inspector must see that the contractor removes and disposes of all highway structures and appurtenances that are not to remain in place. Until they can be delivered to DOT Stores, all drainage pipes and railing material that are not designated to remain in place, or that are not designated for use in the construction and are to remain the property of the State, have to be removed without damage and stored at a convenient location along the highway. The storage location must be a safe distance, a minimum of 30 feet (9 meters) from the traveled portion of the highway.

2-312 Contractor’s Property

All structures that become the property of the contractor must be removed and disposed of before final acceptance, unless instructions to the contrary are contained in the plans or special provisions.

2-313 Use of Reclaimed Waste Materials on Construction Projects

The sources of “reclaimed waste” include debris from demolished buildings, structures, and pavements and residue from resource recovery plants. The materials themselves may include Portland cement concrete, bituminous concrete, glass, ceramics, bricks, pavement subbase and base course, and incinerator clinkers. Metal is acceptable only when contained within large fragments of concrete.

Reclaimed waste brought onto the project must be accompanied by a Materials Certificate and Certified Test Report stating that the material is environmentally acceptable and structurally sound in accordance with Article 1.06.07 of the *Standard Specifications*, unless the material’s source is a transportation project acceptable to the Engineer.

Follow these guidelines in regulated areas when the Department uses reclaimed waste material on construction projects:

- Avoid the use of reclaimed waste on all projects in the immediate vicinity of public water supply reservoirs or tributaries.
- Limit the use of reclaimed waste to areas outside – 3 to 5 feet (1 to 1.5 meters) in both the horizontal and vertical directions – of any water resource-regulated area, including the stream channel encroachment line.

2-314 Conditions Requiring Corrective Work

Field observations during the excavation and embankment stage of construction often reveal troublesome soil or water conditions that were not apparent at the time of the soils survey. Corrective work is often needed to ensure the stability of the roadway. Subsurface drainage requirements are particularly difficult to assess accurately when a preliminary subsurface investigation is made.

During excavation operations, therefore, the Chief Inspector must notify the Project Engineer immediately upon encountering any wet condition that has not been provided for in design. The Project Engineer must arrange to have proper drainage features installed with as little delay as possible. One common wet condition is a natural water flow in underground strata. It can be corrected by the use of open ditches, open channels, or underdrains that effectively intercept and carry off the subsurface water. A high water table is another typical problem. It results in a subgrade that becomes saturated and softened by capillary action. Again, underdrains, open ditches, and open channels are means of removing the water and protecting the roadway.

Besides wet conditions, slip planes in earth and rock slopes are also common. These conditions can lead to severe slides if they are not corrected. To remedy the condition, slopes can be benched, high-level drainage ditches can be constructed to intercept surface water, or high-level underdrains can be installed to intercept subsurface water.

Problems that cannot be corrected as described above should be reported to the District Office immediately. Depending on their nature and seriousness, the Assistant District Engineer may prescribe the necessary corrective work, or the District may refer the problem to the Soils and Foundation Section for recommendations.

2-315 Embankment Building

2-315A General

During the formation of embankments, the Inspector must be vigilant in enforcing the provisions of the *Standard Specifications* regarding the placement and compaction of fill material. Observing the action of fill material under the weight of hauling equipment is the best indicator of relative embankment stability. Any material that continues to pump should be immediately brought to the attention of the Project Engineer.

The Inspector must see that the embankment is constructed to the required width from the bottom up, so that dumping material over the edge of the embankment to widen it will not be necessary later on. If it is necessary to widen existing slopes, the added material should be cut in and compacted, and not just end-dumped and spread. Improperly placed material is very susceptible to erosion and may develop into a minor slide.

The practice of compacting embankments chiefly with hauling, excavating, and grading equipment is not acceptable. The entire area of each layer must be uniformly compacted to at least 95 percent of the dry density for the soil, as determined by AASHTO T180, Method D. Compaction equipment, consisting of rollers, compactors, or a combination of the two, must be used. Earth-moving and other equipment that is not specifically manufactured for compaction purposes will not be considered compaction equipment. See Section 2-319, Embankment Density for more information.

Attempts should be made to alternate haul roads on fills whenever possible to promote uniform compaction.

2-315B Borrow

In general, borrow will be permitted only after all usable excavation has been placed. The contractor may request the Engineer's permission to place borrow before all of the available and suitable excavated material has been incorporated in the work. Such permission, when granted, will specify that the contractor will be held responsible for the proper placing of all suitable excavated materials and that no payment will be allowed for any borrow placed in lieu of suitable excavated material. All borrow banks will be preapproved so that "Proctors" may be determined and cross sections may be taken prior to any excavation.

In embankments being constructed from borrow material, the responsibility of obtaining the necessary consolidation and stability is entirely the contractor's. If consolidation and stability are not being achieved, the operations should be stopped until the contractor demonstrates that a thoroughly compacted and stable embankment can be made with the material being used.

2-315C Corrections

When embankments are formed from excavated material but are unstable after the contractor has complied with the density and other requirements of the specifications, the Assistant District Engineer must be alerted. After viewing the condition, the ADE will determine if corrective measures are necessary and, if so, may direct the contractor to improve the embankment's stability. The corrective work that is deemed necessary will be paid for as extra work, or at contract unit prices if such items appear in the contract. For Federal-aid contracts, the Federal Highway Administration must provide clearance for corrective procedures.

2-316 Monthly Pay Quantities

The practice of determining daily quantities of excavation and borrow by taking load counts is usually recognized as the most practical estimation method. However, the method of estimation used must be documented as outlined in Section 1-912. It is not acceptable to use the summation of these daily counts to determine final pay quantities. Methods must be used to check load-count totals to prevent overpayments.

Inspectors should verify load count accuracy as follows:

- The hauling units should be measured and their water-level capacity should be computed. This information will serve as a basis for determining the quantity to be allowed per vehicle load.
- The load-count data should be submitted, in writing, on a daily basis. For example, the contractor could provide a tally sheet listing each hauling vehicle, showing the number of loads per vehicle, and indicating the work location. The tally sheet should be signed by the contractor's superintendent to authenticate it.
- An inspector checks the contractor's load count tally daily by actual tally count.

- Periodic checks of the load-count quantities also should be made by independent methods of measurement (other than load-count data), and the progress quantities should be adjusted as required. The checks usually can be made against the estimate sheet on completion of a particular excavation area or borrow pit.
- The elevations of the cut areas and borrow banks will be determined just prior to the monthly estimate. This may be done by survey party profiles and cross sections. As an alternative, inspectors may take elevations or make visual determinations – nothing elaborate.

The data will be used independently or in conjunction with information available from grading quantity sheets, detailed estimate sheets, etc., to compute the approximate amount of material excavated. This quantity will be compared to the load-count quantity to determine the accuracy of the load counts. If large discrepancies exist between those quantities, more detailed checking must be performed and the load-count quantities must be adjusted accordingly.

- The results of the checks above and the methods used to determine and check the monthly pay quantities for the various excavation and borrow items must be documented in the project records.

It is the Inspector's responsibility to maintain an accurate load count. If load counts are not available, the Inspector should include a daily entry in the project records documenting the approximate:

- carrying capacity of each hauling vehicle,
- number of loads, and
- total cubic yards (meters) for the day.

These estimates will also be considered as load counts.

Intermediate final sections must be taken in borrow banks if borrow operations are suspended for about a week or more. The information must be included in the permanent project records.

2-317 Final Pay Quantities

To assure compliance with the *Standard Specifications* and to ensure proper documentation of this item, the following policy will apply to all projects:

- All final quantities greater than 5000 cu. yd. (3800 m³) must be measured by cross-section measurements at the borrow pit or by cross-section measurements made in place. The appropriate shrinkage factor mentioned in *Standard Specifications* Article 2.07.04, paragraph (d), must be applied. Only in the case of extenuating circumstances may this method be waived in favor of alternatives mentioned in the *Specifications*. The Office of Construction must be informed of the specific reason or reasons why other methods were utilized.
- Under *Standard Specifications*, Article 2.07.04, paragraph (b), payment by load count, less the shrinkage factor, may be considered an acceptable method of measurement for quantities less than 5000 cu. yd. (3800 m³).

2-318 Winter Embankment Operations

If a contractor requests permission to begin or continue the construction of embankments during the winter, the contractor will be required to remove all frozen material, within specified limits, at no cost to the State. The requirement applies to the removal of frozen existing ground or embankments constructed of earth excavation or borrow located within the following limits:

- As measured from the outside edges of the tops of slopes, the portion of the embankment area that falls within the 1.5:1 slope lines.
- As room permits, between the outside of the 1.5:1 slope and the designated 1:1 slope.

Fat slopes resulting from the placement of the frozen material should be graded to the prescribed slope limits after all material has thawed and become stabilized.

No additional payment will be made for any work involved.

2-319 Embankment Density

Proctor tests are used to determine the laboratory densities of the soils used for embankment construction. Nuclear density gauges typically are used to determine field densities for comparison with the laboratory densities.

2-319A Field Sampling for Proctor Determinations

To be able to compare each field density value with the laboratory density for the same soil, the Inspector must sample and send sufficient material to the District Laboratory so that enough Proctor determinations are made. Each laboratory density test requires approximately 80 pounds (36 kilograms) of material.

For each sample submitted to the Laboratory, the field forces must obtain a small representative sample and retain it on the project as a reference sample. These samples should be placed in glass jars labeled with the following information:

- soil type,
- source,
- Proctor density (at optimum moisture content),
- percent of material retained on the 2 in. (50 mm) sieve,
- percent of material passing the 2 in. (50 mm) sieve and retained on the ¾ in. (19 mm) sieve,
- sample number, and
- laboratory number.

At the time a source sample is taken for approval of a new borrow bank, the Inspector should request a Proctor density and optimum moisture of the material. The request expedites the moisture-density control process in the field, by providing the Inspector with the values that will be needed as soon as the contractor begins the embankment.

If embankment material is obtained from several sources, the importance of comparing the field test results to the laboratory results for the same soil cannot be over-stressed.

2-319B Field Density Test Equipment

Embankment densities can be determined by conventional methods based on a soil sample weight- volume relationship, or by using a nuclear testing device. The Department currently accepts field densities determined by the nuclear testing method.

Because nuclear-density units contain radioactive material, they are subject to the control and regulation of the Nuclear Regulatory Commission (NRC). Only qualified, NRC-certified technicians are authorized to operate this equipment. All applicable safety regulations must be observed.

Nuclear-density devices consist of adjustable moisture and density probes that are power-operated counters. The probes are sealed units containing radioactive material. Each probe has a safety lock-type trigger mechanism that effectively shields the radioactive charge if the mechanism is in the off position. Readings generated by the probes are displayed electronically on an illuminated panel. The readings are referred to as counts per minute, or CPM. For each test run, the panel readings are interpolated on calibration charts for a density and moisture determination.

Each probe has a sending unit. The moisture probe senses the hydrogen molecule content of the water in the soil and transmits the information to the unit. Low readings reflect low moisture content. The density probe senses the resistance of the soil to the radioactive transmissions, and the resultant readings reflect inverse soil densities. That is, low readings indicate high soil densities.

The effective depth of detection for each probe's units is between 6 and 12 in. (150 and 300 mm). For accurate test results, the lower surface of each probe must develop full surface contact with the material being tested. Minor surface irregularities and voids result in count differences of 400 to 500 CPMs. Soils with different densities, if placed in lifts of less than 12 in. (300 mm), require special consideration.

2-319C Field Density Test Procedures and Steps

Before field density tests are conducted, the inspector who will oversee the operation must be familiar with both the representative samples of material submitted to the laboratory for density determinations and the material currently being used. For a density test to have significance, the material being tested and the results obtained have to be compared to the proper laboratory sample.

Not all field density tests on a project are expected to pass, that is, have results that meet the required minimum percentage of laboratory density. If they all passed, it would indicate that:

- They were made only in hard spots.
- They were compared to a laboratory density for a different, poorer soil.
- The contractor did an *outstanding* job by thoroughly compacting every layer for its entire width.

The proper procedure is to run the field density test in a portion of the layer that seems representative of the layer as a whole. The test result is then compared to the laboratory (Proctor) density for that soil. If the field density does not pass, the contractor is immediately told to re-roll the area. After the area is rolled again, a new test is performed to determine whether the additional compaction was sufficient. If the new result also fails to pass, the rolling-and-testing process is repeated until a passing result is obtained.

Additional compaction passes and subsequent tests should be noted under "Remarks" on any Report for the Nuclear Field Density Tests, like Figure 2-3.5. As noted above, the dry density after compaction must not be less than 95 percent of the dry density for the soil when tested in accordance with AASHTO T 180, Method D. If density tests still fail after several re-rollings or are too high, it is possible that the wrong

Proctor is being used. The Inspector should then contact the Lab or possibly resample the material to determine a new laboratory density.

If necessary, the Inspector should have density tests performed in cuts and borrow banks for comparison to densities in fills to determine the amounts of shrinkage and swelling of material incorporated in the work. The information should be given to Soils and Foundations to be used for estimating earthwork on similar projects in the future.

2-320 Water Pollution

2-320A Sedimentation Control Plan

The contractor is required, by the contract “Best Management Practices for Protection of the Environment,” to submit a sedimentation control plan for approval. The plan may be revised after approval when actual field conditions dictate that different controls or more controls are needed.

If possible, the project should be reviewed during a rainstorm to observe high runoff areas and check the sedimentation control plan. This can be critical in determining if the sedimentation control plan is practical and effective. The use of sedimentation silt fence, stone dikes, sedimentation pools, or other controls may be needed. Other options for protecting slopes include temporary bituminous curbing or temporary leak-offs or slope drains.

2-320B Responsibilities

The contractor is responsible for placing and maintaining sedimentation controls. The Chief Inspector is responsible for ensuring that controls are placed and maintained for the duration of the project.

The Inspector should be familiar with all DEEP and Army Corps of Engineers permits associated with the project, ensure the contractor's compliance with their conditions, and be familiar with the required erosion and sedimentation controls and other special project requirements. The Inspector should arrange a site meeting with DOT Environmental personnel to review the erosion-control measures implemented.

2-320C Operations

All sedimentation controls must be in place before construction begins. The contractor's approved dump site for excess material should also be protected before actual dumping occurs.

On rehabilitation projects, curb removal may present a potential runoff and sedimentation problem. If possible, curbing should be left in place until the disturbed slopes have a good stand of grass.

Temporary pollution control measures, other than those shown on the plans or stipulated in the specifications, may be ordered by the Engineer to correct conditions that develop during construction. The field personnel must anticipate possible erosion and pollution during construction and provide or recommend timely installation of necessary temporary controls to prevent those problems from occurring.

Figure 2-3.5 Data and Computation Sheet for Nuclear Field Density Tests (OLD DOT Form CON-125)

The Following is a SAMPLE of a Nuclear Field Density Test

CON-125 Rev. 10/90
STATE OF CONNECTICUT
DEPARTMENT OF TRANSPORTATION
BUREAU OF HIGHWAYS
Printed on Recycled or Recovered Paper

Lab # _____

DATA AND COMPUTATION SHEET FOR NUCLEAR FIELD DENSITY TESTS

Town _____ Rte. No. _____ Project No. _____ Dist. No. _____

Contractor _____ Project Engineer _____

Location of Test Station _____

Offset _____ Depth Below F. Gr. _____

Soil Hauled From (Cut Sta. or Borrow Bank) _____

Tested By _____ Gage Number _____ Date Tested _____

Test Number _____ Soil Type _____

DENSITY		DENSITY		DENSITY	
wet density	dry density	wet density	dry density	wet density	dry density
_____	_____	_____	_____	_____	_____
_____	_____	_____	_____	_____	_____
_____	_____	_____	_____	_____	_____
ave. _____	_____	ave. _____	_____	ave. _____	_____

MOISTURE		MOISTURE		MOISTURE	
lbs. water	% water	lbs. water	% water	lbs. water	% water
_____	_____	_____	_____	_____	_____
_____	_____	_____	_____	_____	_____
_____	_____	_____	_____	_____	_____
ave. _____	_____	ave. _____	_____	ave. _____	_____

CALCULATIONS

A. Wet Unit Wt.	_____	_____	_____	LBS./C.F.
B. Weight of Water	_____	_____	_____	LBS. H ₂ O/C.F.
C. Dry Unit Wt. (A-B)	_____	_____	_____	LBS./C.F.
D. Water Content (B/C)	_____	_____	_____	%
E. Maximum Density (Proctor)	_____	_____	_____	LBS./C.F.
F. Percent of Proctor Density (C/E)	_____	_____	_____	%
G. Optimum Moisture (Proctor)	_____	_____	_____	%

REMARKS:

The Engineer has the authority to control the surface area of earth material exposed by construction operations and to direct the contractor to immediately provide permanent or temporary pollution control measures in accordance with Article 1.10 of the *Standard Specifications*. The Inspector may direct the work to be done by an on-call contractor if not performed by the project contractor within the period required by the specifications. Additional information can be found in Volume 2, Chapter 1, "Environmental Protection," in the section "24-Hour Rule."

The contractor must operate all equipment and perform all construction operations so as to minimize pollution problems. In the event pollution-control measures are required due to the contractor's negligence, carelessness, or failure to install permanent controls as part of the contract or perform work ordered by the Engineer, the work needed for implementing the pollution-control measures must be performed by the contractor at no expense to the State.

2-321 Call Before You Dig (CBYD)

Companies that will excavate should be thoroughly briefed on Call Before You Dig (CBYD) requirements and procedures before project startup. The CBYD program is operated by the Department of Public Utility Control (DPUC). State regulations require that excavating contractors and subcontractors contact CBYD before starting digging, drilling, driving or other operations that might hit an underground utility. After this contact is made, the contractor or subcontractor must wait two days for the area to be completely marked out. Initially requesting a generously wide mark-out of the construction site can both avoid delays and prevent incidents.

Not all utilities are on the CBYD system. Most municipalities are not, and the State of Connecticut is not. Contractors should contact agencies directly that may have utilities that could be damaged but that are not on the CBYD system.

The DOT has an Incident Management System (IMS) along the major expressways in the State. The IMS uses fiber optic cables and conduits. As an exception to the State's exclusion from the CBYD system, contractors should contact CBYD to have the IMS conduits marked.

2-321A Utility Warning Tapes

DPUC regulations require that all underground utility facilities (including railroad facilities) installed after January 1, 1989, be identified with warning tapes above the facility. The warning tape must be located 12 in. (300 mm) above all conduits, wires, cables, utility pipes, drainage pipes, underdrains, etc. The tape must be durable, designed to withstand extended underground exposure, durably imprinted with an appropriate warning message, and of the color assigned to the type of facility for surface markings.

- *Green.* Storm and sanitary sewers and drainage systems, including force mains and other non-hazardous materials.
- *Blue.* Water.
- *Orange.* Communication lines or cables, including but not limited to telephone, telegraph, fire signals, cable television, civil defense, data systems, and electronic controls and other instrumentation.
- *Red.* Electric power lines, electric power conduits, and other electric power facilities.

- *Yellow.* Gas, oil petroleum products, steam, compressed air, compressed gases, and all other hazardous materials.
- *Purple.* Radioactive materials.
- *White.* Proposed excavations.
- *Brown.* Other.

2-321B Reporting

Digging incidents involving public utility facilities call for timely, accurate, and legible reporting of each occurrence. Incidents are to be reported on the Department of Public Utility Control's Incident Report Form, Figure 2-3.6 at the end of the chapter, and submitted to:

Call Before You Dig, Inc.
105 Sanford Street
Hamden, CT 06514

Regulations of Connecticut State Agencies require each public utility to notify CBYD monthly of any excavating activity that has resulted in contact or damage to its underground facilities for electricity, gas, telephone, other communications, sewage, water, traffic and fire signals, community television antennas, and steam and other products carried by pipelines. Contact includes – without limitation – the striking, scraping or denting, however slight, of any underground utility-line protective coating or housing, or other disturbance of the structural or lateral support of any underground utility facility. Additionally, public utilities must also file a report annually with CBYD if their underground facilities have not sustained damage. Failure of compliance by any public utility regarding the submission of the reports may result in a civil penalty.

The Incident Report Form may be used in evidence in actions imposing a civil penalty for any violation of any portion of the law. Detailed information in cases of alleged “excavator negligence” are particularly important and must be clearly stated. Consequently, accuracy, neatness, and timeliness are essential in its preparation and submission. When each report is completed, the preparer should be certain that the top two copies (white and yellow) are sent to CBYD, while the third copy (pink) remains with the preparer.

Chapter 4 - Drainage

2-400 General

This chapter covers the construction and reconstruction of culverts, catch basins and drop inlets, manholes, underdrains, and ditches and channels. This chapter includes more design material than most of the chapters in the Manual because of the responsibility of project personnel to identify where plans need to be modified to improve drainage.

Water causes or contributes to most highway failures. In addition, damage to private or public property can be caused by a drainage structure that is not the right size or is not installed at the right location or elevation. Ideally, potential problems with a project's drainage system should be resolved during design. Unfortunately, actual drainage conditions often are not discovered until after construction starts. The Department must rely on the Chief Inspector and other project personnel to recognize potential drainage problems and request reviews of the design when necessary.

After design problems are resolved, drainage systems should be installed carefully and accurately so that the intentions of the design are realized in the finished construction.

2-401 Purpose

Drainage installations can function in three ways:

- to convey the free flow of natural water courses through highway property,
- to collect surface runoff to prevent flooding and the erosion of the shoulders or slopes, and
- to control subsurface flow to maintain the stability of the roadway.

A highway drainage system accommodates surface runoff, free ground water, or both. Removing surface runoff is relatively simple if compared with removing free ground water that flows or percolates through the pores in soil, holes created by decayed matter, insects, worms, and frost action. The porosity of soil controls the rate of underground channeling, if the slope is sufficient and the flow is not hemmed in by rock or impervious soils.

The subbase is meant to carry away ground water, but it sometimes brings in unwanted water to the subgrade instead, usually in cuts. If the water is not controlled, it removes the fine-grain components of the subbase gravel and causes a loss of the bearing power of the pavement. "Pumping" occurs at the joints and cracks of concrete pavement, caused when the flexing of the pavement under heavy wheel loads results in the movement of the free water. If the lateral movement of the water is restricted by curb footings on impervious material, the flow carries the water and fine grains through the joints, creating voids under the pavement. The loss of support and continuing heavy loads combine to crack the pavement and further the cycle of deterioration.

Capillary flow occurs in fine-grained soils; the force of gravity is overcome, and water can move in any direction. This flow is normal, and the resulting moisture can act as a binder for the soil particles. However, the moisture can become a lubricant if it is in the form of free water. In silt or clay, water can rise about 9 ft. (3 m) and about 18 in. (450 mm) above free-water level in sand. The amount of capillary water held in the soil depends on the characteristics of the soil, the supply of free water that replenishes the capillary water, and the extent of evaporation.

Frost heaves and boils are the result of the formation of ice crystals from the water supplied by capillary action. When water freezes, it increases approximately 9 percent in volume. The resulting expansion force is about 30,000 lbs. (133 kN) or 15 tons/sq. in. (207 000 kPa). With the first frost, the ice crystals fill the

voids near the surface. Capillary water continues to feed the ice crystals, layer on layer, building up pressure until the surface ruptures or the slab is heaved. In the spring, the upper layers of ice thaw during the first warm spell. The thawed areas, when surrounded by frozen ground, develop into water traps that promote softening of the roadbed.

The depth, gradation and proper compaction of the subbase all tend to reduce capillary movement, improve the supporting qualities, and decrease the depth of frost penetration, but the subbase must also be drained to hold capillary action to a minimum. Surface and subsurface drainage installations are used to control free water movement through the subbase.

2-402 Outlets

The status of drainage outlets, the right to discharge water into private property, and the Department's related obligations for maintenance are below.

2-403 Natural Water Course

A natural water course is a channel within highway limits that is available for the discharge of runoff within a definite drainage area, conforming to the original ground contours. A diversion of runoff from another area by the constructed drainage system requires additional rights from the downstream owner. The State is responsible for the free flow of all streams through highway property but does not assume any obligation for the maintenance or improvement of streams on private property. Construction activities are often the source of claims by adjoining owners due to erosion of the channels or sedimentation of ponds. The Inspector should remain aware of the possibility of a claim both prior to and during construction.

2-404 Drainage Right-of-Way

A drainage right-of-way is a deeded easement for the installation and future maintenance of a pipe or ditch through private property, to provide a more suitable outlet. It is preferably located adjacent to the boundary line as a lease encumbrance to the property and varies in width from 10 to 20 ft. (3 to 6 m), depending on the size of the installation. The landowner retains the limited use of the easement area; however, any improvements, such as piping the ditch or extending the outlet, are at the landowner's expense and subject to Department permit requirements.

2-405 Right-to-Drain

A right-to-drain is a deeded right to discharge runoff over land into adjoining property at a specific location. It generally is limited to open land. Future improvements are at the owner's expense.

2-406 Adverse Rights

This type of outlet is not considered in new construction; however, it is the most common cross-culvert installation in rural areas. By statute, the State acquires a right – to – drain after 15 years of continuous use. The problem to property owners has been recognized, and the Department normally cooperates to the extent of installing a maximum of 200 ft. (60 m) of pipe furnished by the owner. The Department installs the structure and maintains the system in exchange for a definite drainage right – of – way.

Volume 2

2-407 Agreements

Outlets into existing town systems are by agreement covering construction and maintenance.

On completion of a project, the Department receives requests for outlets into its systems by private owners, developers or towns. Connections for cellar drains, roof leaders, etc., are allowed subject to a drainage agreement and permit requirements. The discharge of contaminated water from septic tanks or commercial processing is not permitted. Outlets for town improvements or developments also are allowed, assuming that the highway drainage system is adequate and Department rights are not jeopardized. Because circumstances vary, all requests for connections should be referred to the District Drainage Engineer for investigation.

2-408 Runoff Design

State highway drainage systems are typically designed for a 25 year frequency storm, which is the magnitude of one storm expected or experienced every 25 years. Systems at underpasses, depressed roadways, and culverts enclosing natural watercourses are at a 50 year frequency.

Highway and urban land area runoff is computed by the rational formula:

$$Q = \frac{A I R}{360} \quad (Q = A I R)$$

- Q = quantity of water in cubic feet (cubic meters) per second
- A = drainage area in acres (hectares)
- I = percentage of imperviousness of the area, from 0.2 to 0.9
- R = maximum average rate of rainfall over the entire drainage area in inches (millimeters) per hour that may occur over the design frequency

Rural land area drainage is computed by the Izzard method. The factors of design are somewhat similar to the rational formula but are for larger areas and use charts adapted for Connecticut conditions.

2-409 Trench Excavation

2-409A General

Trench excavation is covered in Article 2.05 of the *Standard Specifications*. There are several pay items for trench excavation, differentiated by the depth of the excavation and whether rock is excavated.

Regardless, pay items cover the removal and disposal of material and excavation and backfilling for the following.

- Constructing pipe culverts, endwalls, catch basins, drop inlets, manholes, underdrains and outlets, sewers and service pipes.
- Removing drainage structures and appurtenances beyond the limits of roadway and structure excavation.
- Removing miscellaneous items, such as abandoned underground tanks, pipelines, etc.

Trench excavation is paid for in accordance with the *Standard Specifications* or special provisions. The Inspector should become knowledgeable in the current OSHA standards regarding trenching and advise the contractor to meet the standards, with copies of the advisements sent to the District.

It is not always possible to judge subsurface drainage requirements accurately when a preliminary subsurface investigation is made. During excavation operations, the Chief Inspector must notify the Project Engineer immediately on encountering any wet condition that is not provided for in the design. The Project Engineer must arrange to have proper drainage features installed with as little delay as practicable.

2-409B Rock Excavation

If ledge rock is encountered in trench excavation, the Chief Inspector must measure and record the amount to be removed. Extreme care should be used in recording the quantity of rock in the trench to state whether or not the quantity is to be deducted from the quantity of trench excavation of the applicable depth. Failure to make such notation may result in either overpayment or underpayment of the items involved.

2-409C Backfilling

Material used to backfill a drainage structure must be suitable for the purpose intended. Varved clay, rock, clay-silts, loam or organic soils are not acceptable backfill materials. Any material used for backfill should be compactable, have minimum void contents, be free of large stones, and provide for uniform load distribution and adequate structural support.

The material should be placed in layers of not more than 6 in. (150 mm) after compaction. Mechanical rammers, mechanical vibrators or pneumatic tampers should be used. Hand tampers can be used only with written permission of the Engineer. Consolidation by puddling or jetting should not be allowed because it produces an unstable and unevenly compacted condition.

2-410 Foundations

In general, the life of a drainage unit can be cut short by water seepage, rock breakage, water traps, and damage from uneven settlement or foundation bearing. Paved ditches, paved channels, catch basins, drop inlets and manholes located in rock-cut areas require special consideration of the need for granular cushion material. Information about foundations for specific types of drainage structures is included in the remainder of the chapter.

2-411 Culverts

The most commonly used drainage structure is the culvert, which either passes water from one side of the highway to the other, or (in connection with catch basins) carries highway runoff to a satisfactory place of disposal. The water must be confined to the culverts to prevent erosion and instability of the roadbed.

Article 6.51 of the *Standard Specifications* covers the installation of new and the re-laying of existing culverts. Article 6.52 covers both reinforced concrete and metal culvert ends. Article 5.06 includes endwalls. Bedding material is a separate item under Article 6.51.

2-412 Types of Culverts

2-412A Corrugated Metal Pipe

Corrugated metal culverts are sometimes called “flexible” pipe structures. The strength of a metal pipe depends on its size, shape, gage, bedding and backfill. The steel sheets or plates used in the pipe are corrugated to provide high flexural strength. Most metal pipe used for highway purposes is coated with a tough, semi resilient, waterproof bituminous material. Invert areas are paved with durable bituminous material. A typical invert covers about 25 percent of the interior circumference of a pipe. It is paved to protect the flow line from abrasion and to improve the flow characteristics of the pipe. See Figure 2-4.1.

A corrugated metal pipe or pipe arch is manufactured from corrugated sections that are riveted together along the longitudinal and circumferential seams. Generally, the sections are riveted together in multiples of 24 in. (600 mm), but pipe is available in lengths that are not multiples of 24 in. (600 mm). Manufactured lengths seldom exceed 20 ft. (6 m) because of handling and transportation restrictions.

Figure 2-4.1 Paved Invert

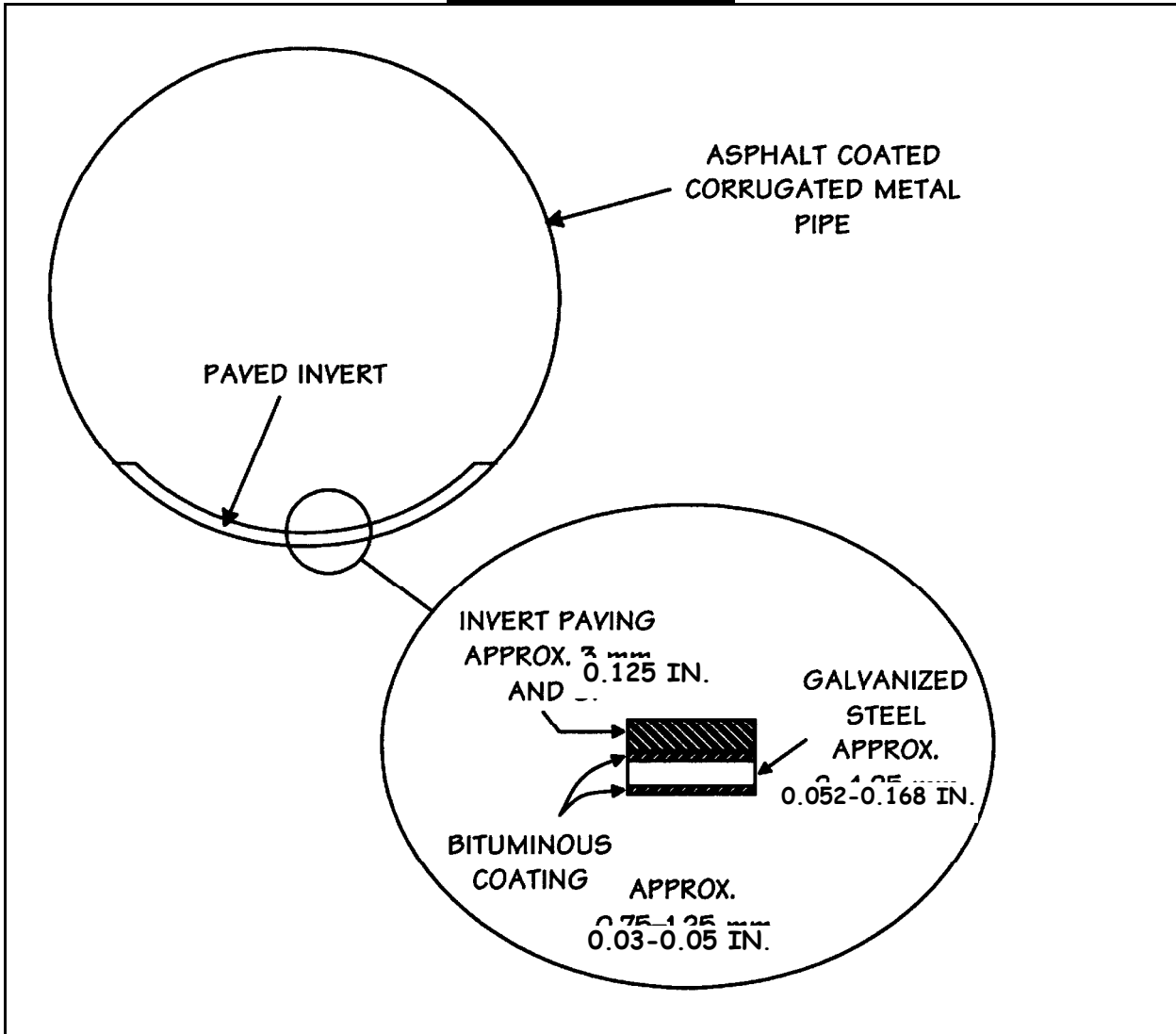

2-412B Plate Pipes and Arches

Structural plate pipe, plate-pipe arches and plate arches are usually field assembled from pre-curved, corrugated metal plates.

2-412C Concrete Pipe

Concrete pipes are commercially produced up to a diameter of 108 in. (2 700 mm). Most of the concrete pipes used for highway purposes have diameters between 12 and 72 in. (300 and 1 800 mm). Pipes of the same size may be made of concrete that has different strengths. Strength is indicated as “pipe class.” There are five classes, Class I through Class V. A higher pipe class indicates a higher strength.

Pipe in one pipe class may be manufactured with different wall thicknesses. Wall thickness is denoted as Wall A, Wall B, or Wall C. Wall A is the thinnest wall. The pipe-wall designation reflects the minimum wall thickness in inches (millimeters), the reinforcement requirement, and the minimum concrete strength (the same for each class of pipe). Circular pipe is reinforced with circular reinforcement, and elliptical pipe is reinforced with elliptical reinforcement.

Improvements and refinements in the manufacturing process and the development of high-strength, low-slump concrete mixes have enabled pipe manufacturers to produce pipe that conforms to rigid specifications.

2-413 Pipe Selection

Since 1959, design standards for drainage have been revised with a general increase in pipe sizing to provide for more extreme conditions. The design for each drainage area considers the slope, ground cover, soil, and future development that may affect runoff characteristics. Pipes are sized by the Manning formula, with special attention to outlet conditions and critical slopes.

2-413A General Guidelines

A designer is guided in the selection of the type of pipe (metal or concrete) and the cross section to use by the following considerations.

- *General.* Reinforced concrete pipe is used if water is not corrosive, cover is adequate, and the height of fill is limited. Asphalt-coated corrugated metal pipe (ACCMP) or pipe arches are used if clearances are limited, in high fills, for grades over 10 percent, and where uneven ground support is expected.
- *Depth of Fill.* For fills in excess of 25 to 30 ft. (7.5 to 9 m), ACCMP usually is used. Reinforced concrete pipe is used if the height of fill is not over 25 ft. (7.5 m) or not over 20 ft. (6 m) for pipe 36 in. (900 mm) or larger.
- *Flow-Line Gradient.* ACCMP usually is used if the flow-line grades are in excess of 10 percent. Corrugated metal pipe frequently is used as slope pipe to connect roadbed drainage units to drainage outlets. Corrugated-metal pipe elbows usually are installed in the run of slope pipe along the toe of a slope to provide for flow-line gradient adjustment, additional cover over the pipe, and an improved outlet or endwall connection to the end of the slope pipe.
- *Hydrology Criteria.* To satisfy flow requirements and installation restrictions, pipes having arch-shaped sections may need to be used instead of round pipe.

The gage or wall thickness of culverts varies with the size of the structure and the height of fill over the installation. Availability also plays a role in pipe selection.

2-413B Available Metal Pipe

Most of the metal pipe culverts used in Connecticut are of the following types and sizes.

- *Asphalt-Coated Corrugated Metal Pipe.* 12 in. to 72 in. (300 to 1800 mm) diameter, gage variable.
- *ACCOMP Arch.* 17 × 13 in. (450 × 340 mm) to 71 × 47 in. (1 800 × 1 190 mm) size, gage variable.
- *Corrugated Structural Plate Pipe.* Size and gage are variable.
- *Corrugated Structural Plate Arch.* Size and gage are variable.
- *Corrugated Structural Plate-Pipe Arch.* Size and gage are variable.

2-413C Concrete Pipe Strength

The strength or class of concrete pipe required for a location depends on the pipe's size, height of the fill, foundation conditions, depth and width of trench, bedding, and backfill. Generally, reinforced concrete pipe must conform to AASHTO M170. Class IV, Wall B meets strength requirements for pipe from 12 in. (300 mm) diameter through 72 in. (1 800 mm) diameter. Class IV, Wall C meets strength requirements from 78 in. (1 950 mm) through 84 in. (2 100 mm) diameter. If the culvert is installed by jacking, extra strength pipe or pipe of a higher class usually is used.

2-413D Loading

General principles for the loads carried by pipes are below.

- For conditions that produce a maximum load on the pipe, the weight of the fill is carried partly by the pipe and partly by friction against the sides of the trench.
- The width of the trench at the top of the pipe has a definite effect on the load to be carried by the pipe. The load is greater for wide trenches than for narrow trenches if the width is kept constant. Sloping the side of the trench has little effect on the load on the pipe.
- The load on a pipe due to the weight of the fill increases with the depth, but at a diminishing rate. After the depth of the fill is approximately ten times the width of the trench at the top of the pipe, there is practically no increase in the load for greater depths of fill.
- The maximum load due to the fill on the pipe usually occurs at the first thorough flooding of the trench fill after construction. The general effect of a lapse of time after the backfill has been compacted is to decrease the load on the pipe.

2-414 Materials Inspection

Culvert materials are tested and inspected by personnel from the Department's Materials Testing Laboratory and are inspected by project personnel.

2-414A Corrugated Metal Pipe

Laboratory personnel perform a general field inspection of the pipe when it is delivered to the job site and collect samples for testing. For ACCM pipes and arches, the inspection and tests check that the following items meet specifications:

- the variation between actual inside dimensions and nominal dimensions,
- the variation between the dimensions of abutting pipe ends,
- the type and thickness of the metal,
- the types of seams,
- the spacing of rivets and the distances from the rivets to the edge of the metal,
- the thickness of the asphalt coating, and
- the width and thickness of the paved invert.

Coupling bands are checked for dimensions and the presence of asphalt coating (no minimum thickness is specified). Pipe elbows are checked for the same items as pipes and arches and for the width of the coupling bands. Culvert ends are checked for the presence of asphalt or tar-based coating and for the configuration of the attachment system.

Project inspection personnel should inspect the material for damage that affects the pipe shape or dimensions, for bent ends that affect coupling, and for damage to the asphalt coating. The inspections should be conducted when the material is delivered to the job site, when it is transported to the installation site, and after it has been installed.

2-414B Concrete Pipe

The Laboratory inspects and approves the materials and the construction methods employed when the pipe is manufactured. Samples of the cured pipe are inspected for surface defects and size variations and are tested by the three-edge bearing test for quality and strength and by the absorption test. Precast materials delivered to the site must be accompanied by a PC-1 Form that verifies Laboratory approval. An example form is shown in Figure 2-4.2.

All pipe used on a project must be inspected and approved by the Laboratory. Laboratory personnel place a stencil on all approved pipe. As with ACCMP, project personnel should inspect the pipe when it is delivered to the job site, when it is transported to the installation site, and after it has been installed. Some inspection guidelines are as follows.

- Each section of pipe should be clearly marked with the pipe class, date of manufacture, and name or trademark of the manufacturer. Note: The stenciled date should match the date given on the PC-1 Form.
- Pipe must have no fractures or cracks passing through the shell, except for a single end crack that does not exceed the width of the joint.
- Pipe must not have any defects that indicate imperfect proportioning, mixing or molding or that indicate honeycombed or open texture.
- Pipe must have no damaged or cracked ends that would prevent making a satisfactory joint.

- Pipe must have no exposed circumferential reinforcement, which indicates misalignment of the reinforcement.
- Pipe must not have any continuous crack having a surface width of 0.01 in. (0.25 mm) or more and extending for a length of 12 in. (300 mm) or more, regardless of the position in the wall of the pipe.

Pipe may be repaired, if necessary, because of accidental injury during handling. The pipe is acceptable if the repairs are sound and properly finished and cured, and the repaired pipe conforms to the requirements of the specifications. The exposure of the ends of the longitudinal steel, stirrups, or spacers that have been used to position cages during the manufacturing process are not cause for rejection.

2-415 Culvert and Endwall Layout

Except in specifically designated instances, the Inspector must have the endwalls constructed parallel to the highway tangent, or when on curves, perpendicular to the radius passing through the centerline or the culvert, with the top plane longitudinally parallel to the gradient of the road.

2-415A General Method

To attain statewide uniformity, the Inspector uses the following method to verify the layout of culverts and endwalls by the contractor:

- Determine the station and distance from the centerline to both ends of the pipe.
- Determine the elevation at the edge of the shoulder, by applying the crown or superelevation for the pavement to the pavement centerline elevation.
- Compute the elevation of the embankment 12 in. (300 mm) back from the end of the pipe, using the known rate of slope. The endwall should be a minimum of 7 in. (175 mm) higher for 1.5:1, 2:1, and 4:1 slopes and 3 in. (75 mm) higher if it is at or close to the edge of the shoulder.

The endwall is staked parallel to the edge of the shoulder and on the same grade, except that at the foot of deep fills the endwall may be staked with a level grade. The ideal location for the end of the pipe is such that the embankment slope coincides with the top of the end of the pipe.

2-415B Field Method

One method of verifying the layout in the field is depicted in Figure 2-4.3. Set stakes at the regular 20 m (66 ft.) station on both sides of the pipe, with the grade of the edge of the shoulder marked on the stakes. Stretch a string between the two stakes and measure the distance at right angles from the edge of the shoulder to the end of the pipe. Compute the vertical distance from the top of the slope to the top of the fill over the pipe and mark it on a stake at the end of the pipe. A string carried from the mark to the edge of the shoulder represents the finished slope line.

Figure 2-4.3 Endwall Layout

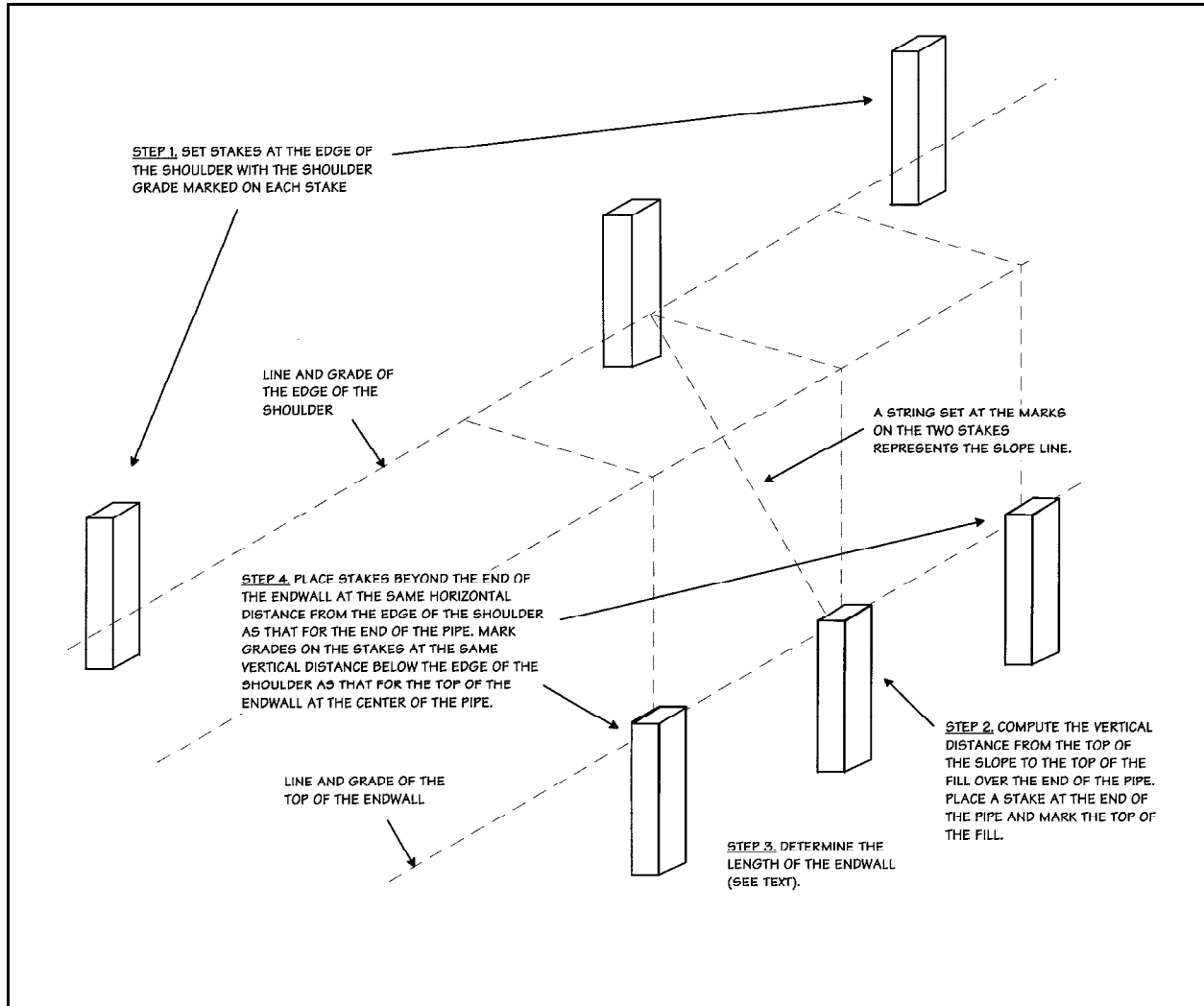

Check the height above the flow line of the pipe with the length of the endwall to be sure that material spilling around the ends of the endwall does not block the drainage way. The relationship between the height and length of a straight endwall is given by the equation:

$$L = 3S + D \quad (L = 3S + D)$$

- L = Length of the endwall in feet (meters)
- S = Height from the flow line of the pipe to the intersection of the slope line and the face of endwall (minimum = D + 2 in. (50 mm))
- D = Nominal diameter of the pipe in inches (millimeters)

Fill material that spills around the ends of an L- or U-shaped endwall forms cones. The wall must be of sufficient length to prevent spillage from blocking the inlet or outlet channel or ditch.

After the length of the endwall is determined, place stakes beyond the ends of the endwall at the same horizontal distance from the edge of the shoulder as for the end of the pipe. Mark grades on the stakes at the same vertical distance below the edge of the shoulder as was determined for the top of the endwall at the

center of the pipe. This procedure will result in the endwall being parallel to the roadway in both line and grade.

2-416 Trench Excavation

If a pipe is to be laid in a cut section, the bottom of the trench is graded to match the bottom of the bedding material or to afford a uniform, firm bearing for the length of the pipe. If rock is encountered, it must be excavated to at least 12 in. (300 mm) below the bottom of the pipe, and the excavation must be filled with bedding material and tamped.

If pipe is laid in a fill area, the embankment is placed and compacted to 12 in. (300 mm) above the elevation of the top of the pipe. Then the trench is excavated.

2-417 Foundations

All new or re-laid pipe culverts are installed in pipe bedding. Pipes with an internal diameter of less than 48 in. (1 200 mm) are installed in Type I installations, and larger pipes are installed in Type II installations.

A Type I installation consists of installing the pipe or pipe arch in bedding material with a thickness directly under the pipe of 4 in. (100 mm) and preshaped to a height of 10 percent of the total height of the pipe. After the pipe has been installed, the trench is backfilled with bedding material to a height of 25 percent of the total height of the pipe.

A Type II installation consists of installing the pipe or pipe arch in bedding material with a thickness directly under the pipe of 4 in. (100 mm) and preshaped to a height of 10 percent of the total height of the pipe. After the pipe has been installed, the trench is backfilled with bedding material to a height of 12 in. (300 mm) above the top of the pipe.

All poor foundation conditions must be corrected. If the supporting soil has non-uniform loadbearing capacity (hard and soft spots), the excavation should be carried below the bedding line and granular fill used as the replacement material. Soft, unstable material in small pockets should be completely removed. Soft, unstable material encountered at the bedding level should be excavated below the designated grade, to the depth specified by the Engineer, and backfilled with granular fill. In unusually wet conditions, the Engineer may direct that crushed stone with a geotextile cover be substituted for the granular fill.

Figure 2-4.4 shows both Type I and II installations when gravel fill is used. Figure 2-4.5 shows the installations when gravel is not used.

Figure 2-4.4 Pipe Installations with Gravel Fill

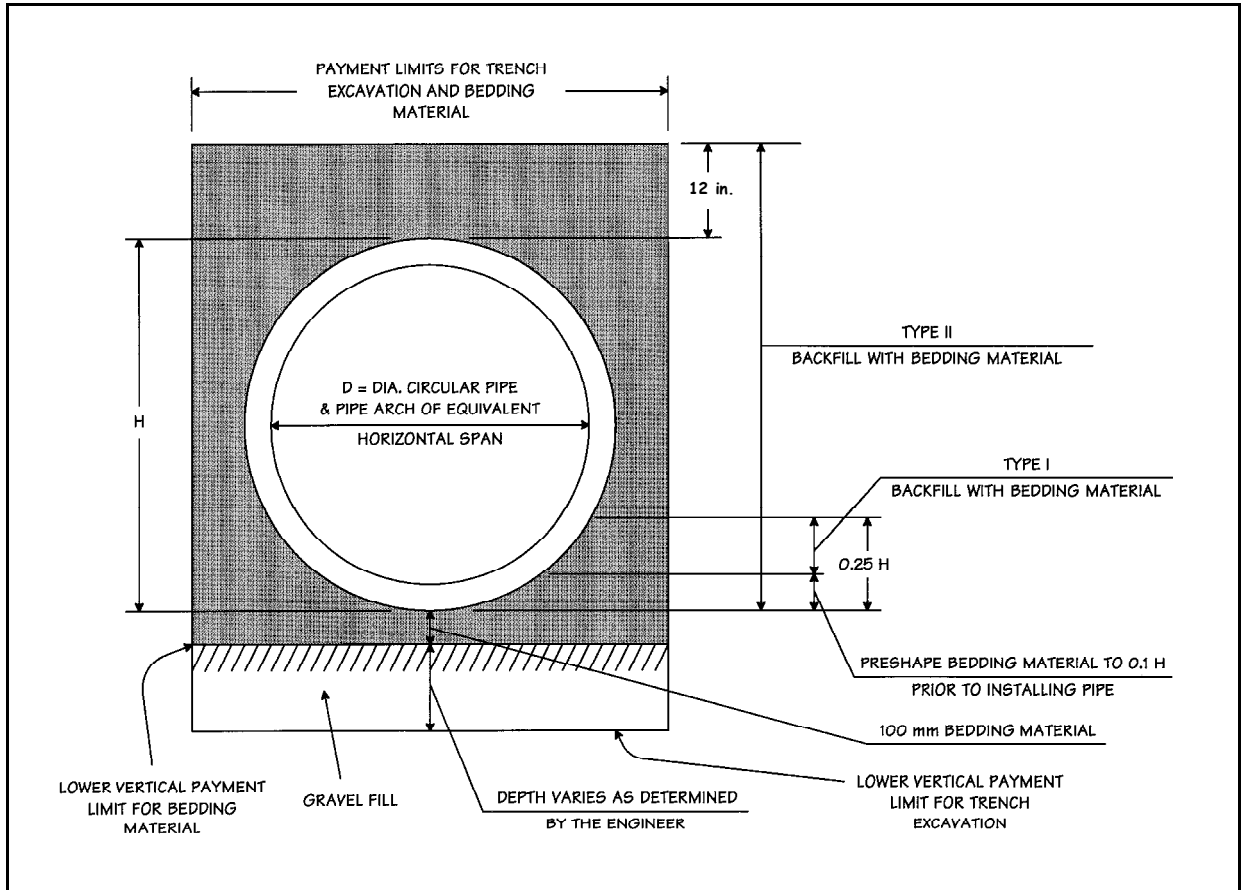
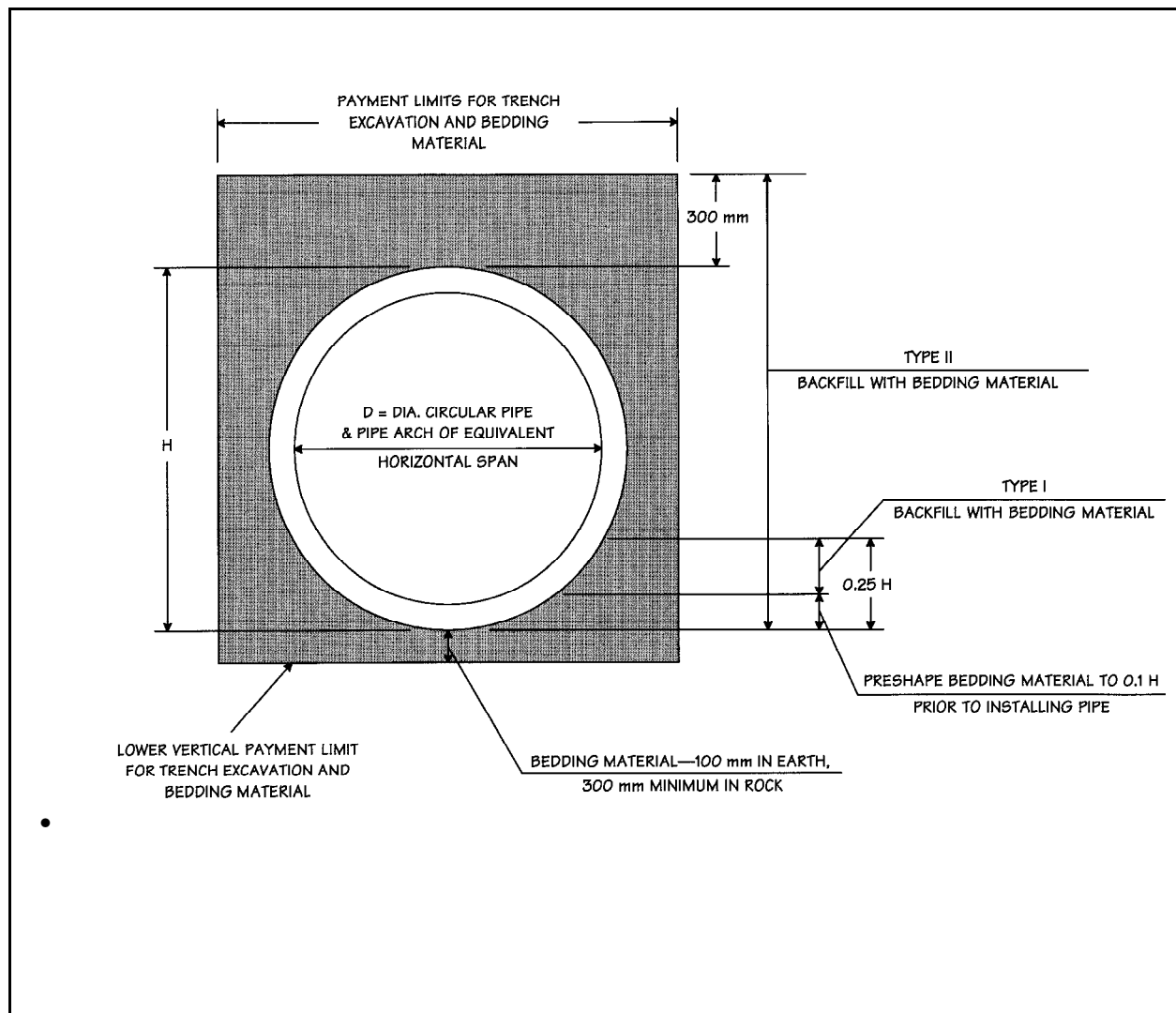

Figure 2-4.5 Pipe Installations without Gravel Fill



2-418 Culvert Installation

When culverts are being installed, the following recommendations should be followed.

- Check the foundation, and if the underlying material is unsuitable, remove and replace it with granular fill.
- Install a minimum of 12 in. (300 mm) of bedding material or granular fill under cross culverts where ledge is encountered. The bed for the pipe should be formed true to line and grade and fully compacted so that it is unnecessary to place additional material under the pipe after laying it.
- Start laying the pipe from the outlet end of the culvert and place the pipe with the bell ends, if any, up grade.
- Place cold-applied bituminous sealer, preformed plastic gaskets or flexible watertight rubber gaskets in the invert of the bell of each concrete pipe before entering the spigot of the succeeding pipe.
- Wipe the joint on the inside of the pipe clean and smooth.
- Bring up the backfill equally on both sides of the pipe and tamp each successive 6 in. (150 mm) layer.

- Place at least 12 in. (300 mm) of cover over the pipe before allowing equipment to pass over it. The contractor is responsible for damage to culverts caused by equipment, regardless of cover.

In fills with depths of 15 ft. (4.5 m) or over, metal pipes of 48 in. (1200 mm) or greater diameter are shored up on the inside while the embankment is being formed to prevent the weight of the fill and the impact of equipment from deflecting the pipe.

2-418A Corrugated Metal Pipe

Pipe lengths are jointed on the job site with connecting bands that are made of the same steel as the pipe. All pipe should be installed with the inside laps downstream and the longitudinal laps toward a side of the trench. Bands are corrugated and should be lapped equally over adjoining ends of pipe sections. The diameter of the pipe determines the width of a band, the number of corrugations it will have, and whether it is a one-piece or two-piece unit. Satisfactory connections are easily made if the pipes are properly aligned, the band and pipe corrugations are carefully matched, the band is tapped with a mallet after preliminary tightening of the bolts, and all bolts are tightened uniformly. One-piece bands should be placed around the diameter of the pipe with the bolts in a vertical position. Each band, in meshing with the corrugations of the pipe, separates the two sections of pipe by the width of one corrugation.

2-418B Plate Pipe and Arches

Erection should be in accordance with the manufacturer's assembly instruction. Multiplate structures should be assembled with as few bolts as possible until all the plates are in place. Three or four loose bolts installed near the center of each plate along the longitudinal and circumferential seams are usually sufficient. After several complete sections have been assembled, the remaining bolts can be loosely installed, always working from the center of a plate toward the corner of the plate. Corner bolts should not be installed until all others are in place and tightened.

All bolts must be well tightened. Final tightening should be carried from one end of the structure to the other after all the plates are assembled. The operation should be repeated to ensure that all nuts are tightened evenly. Any damage to the bituminous coating on the inside or outside of the assembled unit must be repaired before the placement of the backfill material. Inverts are to be paved in accordance with the requirements of the plans and specifications for the item.

2-418C Concrete Pipe

Elliptical and circular pipe should be installed such that the manufacturer's marks designating the top or bottom of the pipe are not more than 5 degrees from the vertical plane through the longitudinal axis of the pipe. Pickup holes should be sealed with mortar or precast plugs, grouted in place. Stones should not be used to plug the holes.

2-419 Backfilling

Special consideration must be given to the placement and compaction of material under the bottoms of pipe arches and under the haunches of pipes. The bedding material should be in intimate contact with the bottom or haunch of the structure and extend to the undisturbed wall of the trench or to the payment width used for trench excavation, whichever is less. If culverts under embankments are constructed prior to filling operations, the embankment fill should be placed and compacted in conjunction with the structure backfill.

Material placed around pipes should be placed evenly, at approximately the same elevation on both sides of the structure. In fill areas, the embankment is placed and compacted to an elevation 12 in. (300 mm) above the top of the proposed pipe. Then the trench excavation is made and the pipe is installed. The cover over the pipe should be increased if it is anticipated that heavy hauling will traverse the pipe.

During the backfilling operation, large-diameter metal pipes usually are strutted. Corrugated metal pipe usually is strutted along the horizontal diameter with wires or steel rods and turnbuckles or along the vertical diameter with timbers, so that the pipe section is changed from circular to elliptical during installation, backfilling and completion of the embankment. Corrugated metal pipe structures deflect under load. Changing the section during installation is necessary so that allowance can be made for deflections resulting from the overlying embankment, and the pipe can return to a full round shape. The resultant changes in diameter lengths enable the pipe to compress the backfill and build up increasing side support for the structure.

Corrugated metal pipe usually is strutted at the time of manufacture in accordance with standardized elongation requirements for various fill heights and pipe sizes. When the pipe is placed on the prepared grade, check the horizontal and vertical diameter at each strut. Excessive elongation differences are adjusted before any backfill is placed. All struts should be slowly and carefully released after embankment placement and consolidation have been completed. To minimize the danger of the pipe bending at the struts, the pipe must be permitted to deflect slowly as the load is applied.

2-420 Drainage Structures

2-420A Materials Inspection of Precast Units

Precast units are accepted on the basis of the manufacturer's certification. The Laboratory inspects the manufacturer's facilities, fabrication procedures and materials tests, similar to its inspection for concrete pipe. However, final approval of individual precast units is the responsibility of the District. All precast units received on the construction site must be inspected by District inspection personnel. Individual units may be rejected for any of the following conditions:

- Units that do not bear proper identification, such as manufacturer's name or trademark or date of manufacture.
- Catch-basin or drop-inlet tops and sumps that are cracked, show evidence of honeycomb, or have patched areas in excess of 30 sq. in. (19 350 mm²) on exposed surfaces.
- Manhole riser sections, bases and appurtenances, catch basins, or drop inlets that exhibit the following:
 - Fractures or cracks passing through the wall, except for a single end crack that does not exceed the depth of the joint.
 - Defects that indicate imperfect proportioning, mixing and molding.
 - Surface defects indicating honeycomb or open texture.

- Damaged or cracked ends if the damage prevents making satisfactory joints.
- Any continuous crack having a surface width of 0.01 in. (0.25 mm) or more and extending for a length of 12 in. (300 mm) or more, regardless of the position in the section wall.

Damage to precast units resulting from accidents in handling may be repaired, if necessary, and will be accepted if the repairs are sound and properly finished and cured, and if the repaired unit conforms with the requirements of the specifications.

Each precast unit should be clearly marked by the manufacturer with the date of manufacture and the name or trademark of the manufacturer. This information, together with the DOT stencil number on the steel frames and grates for catch-basin or drop-inlet tops, is obtained by District personnel from each precast unit delivered to the project and is submitted to the Laboratory on the Request for Test form (Form MAT-100, see Figure 1-4.1), with one copy of the Certification of Precast Concrete Products (Form PC-1, see Figure 2-4.2) furnished with each shipment by the manufacturer. On receipt of the required information and Certification, the Laboratory issues a test report documenting acceptance of the precast units.

2-420B Culvert End Treatment

2-420B.1 Endwalls

Endwalls are constructed of Class A concrete at the entrance and outlet of culverts to retain the slopes adjacent to the entrance and outlet, to prevent water from undercutting or bypassing the culvert, to prevent erosion, and to direct the flow of water into the culvert. The Inspector should compare the designed structures with actual field conditions to ensure that the endwalls function as intended. The Inspector should refer any condition that is in need of correction to the Project Engineer.

2-420B.2 End Sections

Current design practice requires the use of culvert ends, instead of endwalls, if feasible. Culvert ends are placed on a prepared bed of the existing ground or a bed of compacted granular fill. After the attachment of the culvert end to the culvert, backfill is placed around both sides of the unit to the prescribed surface, exercising caution to avoid displacement or deformation of the unit.

2-420B.3 Endwall Improvements

Endwalls may have to be removed or splash pads built during rehabilitation projects. The work must be performed in accordance with the plans and specifications for the project.

When an endwall is removed, a section of the pipe, back to its next joint, must also be removed. An allowance for replacing this portion of pipe may not have been included in the estimated quantities for that pipe item. If this is the case, an overrun in quantity of that size pipe may be unavoidable.

During the replacement of an endwall with a flared end section and splash pad, the Inspector may observe that the elevations of the pipe invert and the splash pad are below existing ground level. The difference in elevation is usually caused by sedimentation from storm and snow runoff in the years since the original work was done. Only the amount of excavation necessary to remove the endwall and install the flared end section and splash pad should be made. Any further excavation violates the DEEP permit requirements.

The Inspector should make a note of the area and forward it to DOT Maintenance for its records and possible correction.

2-420C Box Culverts

Small stream crossings are frequently most economically achieved by using culverts of a special design instead of a bridge structure. Inspection procedures for reinforced-concrete box culverts are the same as for bridge structures. Volume 2, Chapter 8, "Structures," includes bridge inspection procedures. All work relating to excavation, foundation preparation, reinforcement and concrete placement, waterproofing and backfilling operations must be carefully and diligently performed in full compliance with the shop drawings and specifications. Special attention should be given to foundation preparation and settlement or camber allowance. Concrete culverts usually are constructed in sections, and it is required that all joints be clean, properly sealed, and watertight.

2-420D Catch Basins and Drop Inlets

2-420D.1 New Construction

Catch basins and drop inlets are roadway-level interceptor units constructed in shoulder or gutter areas to remove surface runoff. Basin depths vary according to the flow line elevation of the outlet pipe. The depth of sumps must be a minimum of 24 in. (600 mm). Excavation for the structures is payable as trench excavation. Catch basins and inlets are covered in Article 5.07 of the *Standard Specifications*. A typical catch basin (Type CL) is shown in Figure 2-4.6.

The base area must be carefully graded and provide for uniform foundation support. Yielding material must be removed and replaced with granular material. In rock, a tamped granular base cushion is recommended. Side walls can be built of brick, Class A concrete, cement-rubble masonry or precast concrete units. The upper 24 in. (600 mm) of all basin sidewalls are corbelled to provide a satisfactory fit for the top. Corbelling must be in accordance with the details shown on the standard drawings.

Pervious material is used as the backfill material for the upper portion of the excavation down to the invert of the outlet pipe, with a maximum depth limit of 3 ft. (1 m) below the top of the structure. Drainage openings are formed in all walls at or immediately above the bottom of the pervious backfill. The inverts of drop-inlet bases must be carefully shaped to the required cross section.

The Inspector should check the location and grade stakes of all basins before the base is constructed. Accurate stakeout is required for proper basin location. The corbelling can be altered slightly to ensure a good fit on the top. The maximum corbel allowed is 3 in. (75 mm) per course of masonry. All pipes are to be cut flush with the face of the inside wall. In sandy soils, the interior wall faces shall be damp-proofed from the floor to the elevation of the outlet flow line.

Top units may be precast or cast in place. Cast – in – place top units shall be given a 0.04 gal./sq. yd. (0.2 L/m²) application of protective compound after the curing period. Precast units have the protective compound applied at the fabrication plant.

Cast – in – place tops must conform to the dimension and material requirements of the specifications. All tops must be depressed in accordance with the gutter strip details noted on the applicable standard sheet. All frames and grates must be galvanized.

2-420D.2 Resetting Catch Basins

Catch basins may need to be reset during rehabilitation projects to match a new pavement. The work is done in accordance with the plan and contract specifications and with the *Standard Specifications*.

Figure 2-4.6 Catch Basin (Type CL)

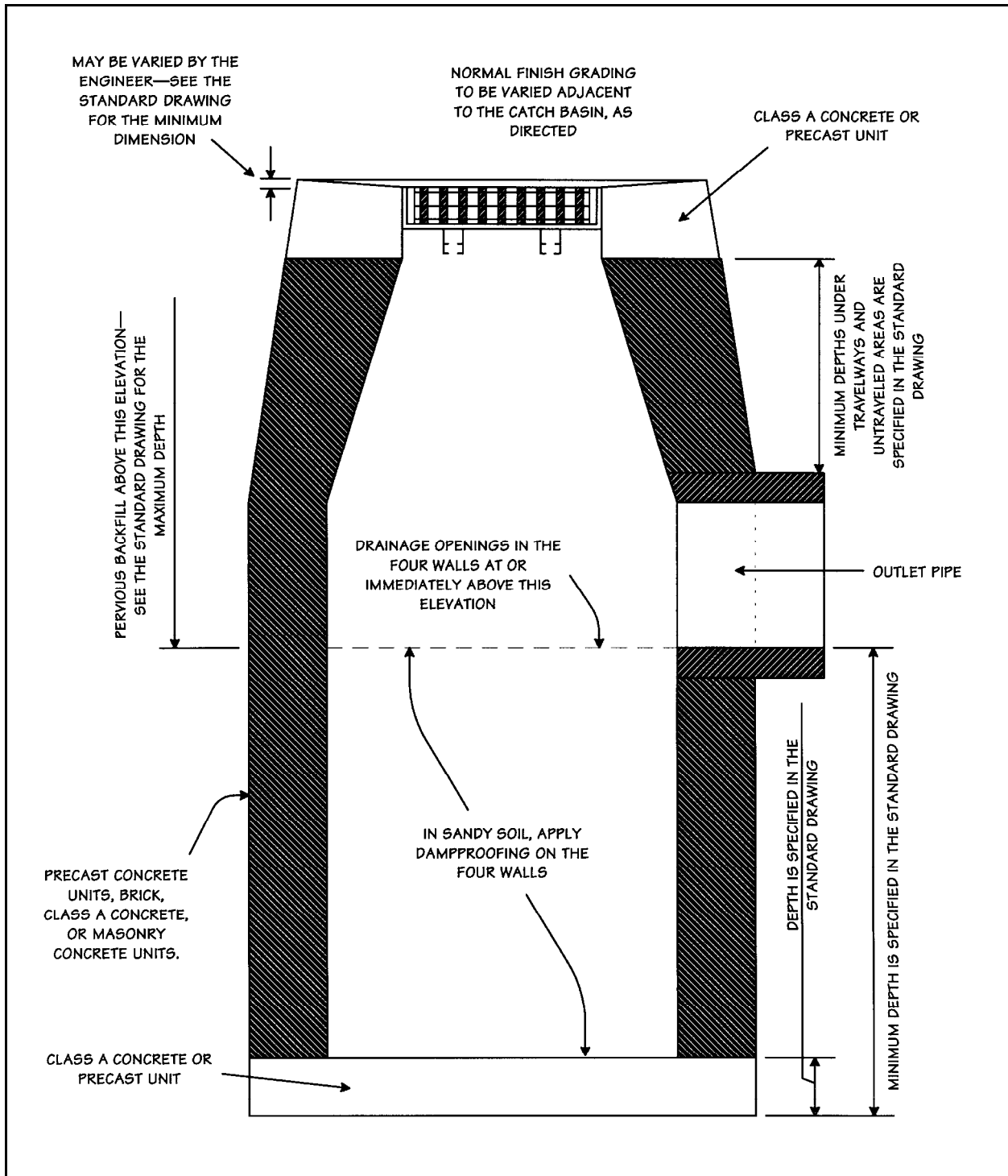

Inspect all catch basin tops and structures for structural soundness. If new tops are needed, or the structure needs rebuilding or replacement, a new item price agreed to with the contractor must be obtained as soon as possible. A Construction Order is necessary for approval of the additional work. The catch basin must be repaired or replaced before final paving can be done.

The catch basin must be set such that the top of the grate is flush with the pavement at its inside edge and the slope of the grate closely matches the cross slope of the gutter, if one is present. The gravel exposed around the catch basin must be compacted in accordance with the specifications before the bituminous concrete patch is placed.

2-420E Manholes

Manholes are concrete brick, Class A concrete, or precast concrete units of variable depth, constructed over drainage lines to effect changes in pipe size, grade or alignment. Manhole foundations must provide for adequate structural support. Channels may be shaped in the concrete base of the manhole or formed of brick.

Manholes located in bituminous concrete pavement usually are set to grade after the binder course has been placed. Manholes located in concrete pavement should be set to grade after the forms are in place.

2-421 Underdrains

Underdrains are designed either to intercept subsurface water from outside sources before it reaches the roadbed, to remove and dispose of free subsurface water from within the roadbed, or both. They are covered in Article 7.51 of the *Standard Specifications*. A typical installation is shown in Figure 2-4.7. Planned locations of underdrain installations are based on the findings of the soils survey.

If questionable subsurface drainage conditions are encountered, the Inspector should notify the Project Engineer. If a condition warrants expert technical advice, an engineer from Soils and Foundations may be contacted to determine the best method for its correction.

2-421A Subsurface Drainage Systems

Subsurface drainage systems consist of interceptor and outlet pipes and are classified into these pay items: Underdrains, Foundation Underdrains, Slope Underdrains, Structure Underdrains, and Outlets for Underdrains. Perforated concrete pipe, cradle-invert clay pipe, perforated asphalt-coated corrugated metal pipe, perforated PVC pipe, or perforated aluminum pipe is specified as the type of pipe to be installed.

Underdrains generally are installed parallel to the roadway, 3 to 4 ft. (1 to 1.2 m) below the bottom of the subbase. Only in exceptional instances should the inside edge of the drain be located less than 12 in. (300 mm) from the outside edge of the pavement. When the objective of a proposed underdrain is to intercept seepage water before it reaches the highway, the Inspector should locate the underdrain as close to the bottom of the cut slope as practicable with the equipment used.

Foundation Underdrains are used to drain rock cuts, springs or pocketed basins under the road and subbase where long grades, depth changes, and superelevation about median areas results in potential water traps. Installation is 3 to 4 ft. (1 to 1.2 m) below the bottom of the pavement.

Outlets for Underdrains consist of standard pipe of the type specified, installed between the terminal end of the perforated pipe underdrain and the outlet drainage structure. Where practical, outlet pipes should be

connected directly to other drainage structures. Independent outlets must be terminated with a standard underdrain outlet endwall.

Figure 2-4.7 Underdrain

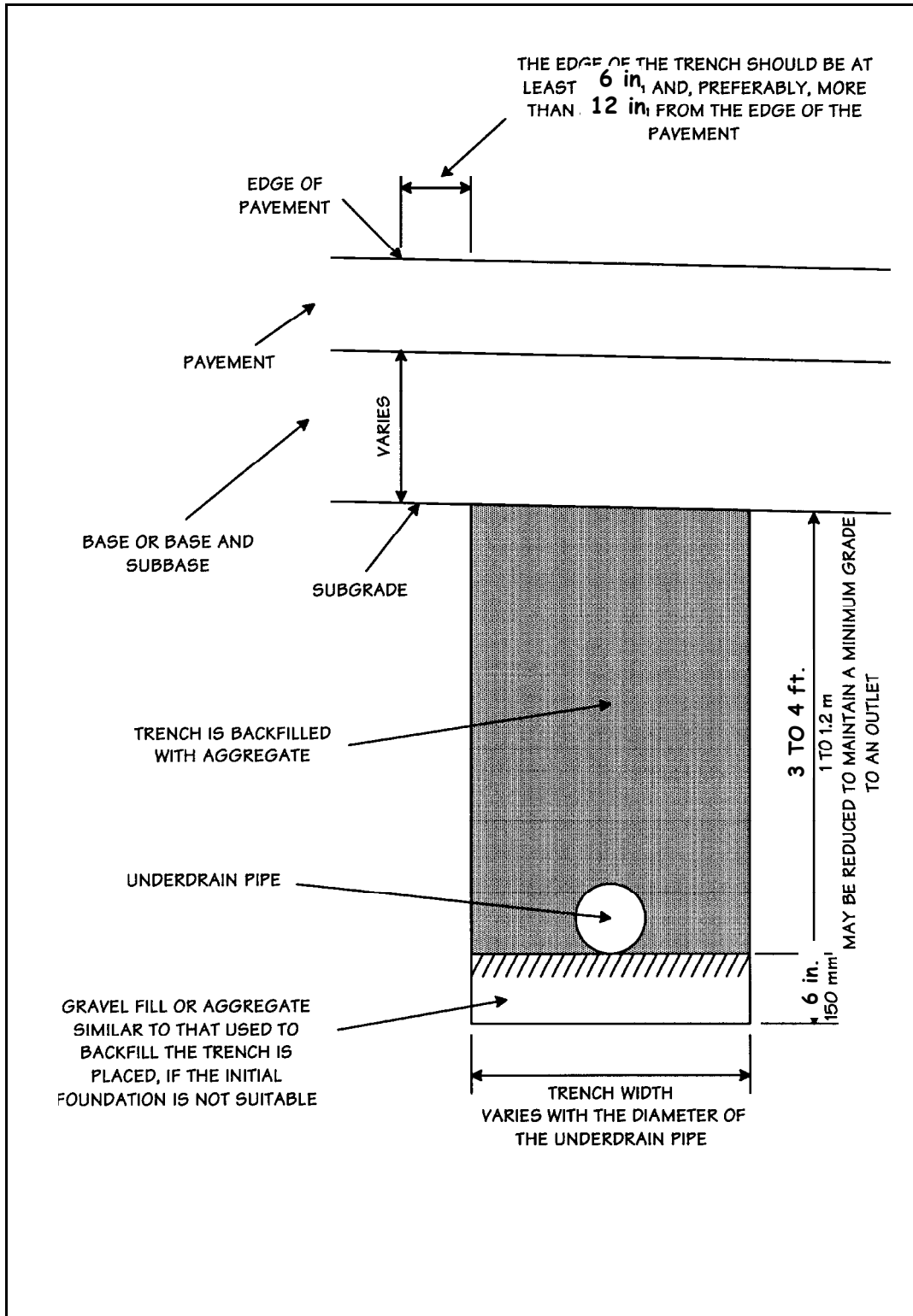

2-421B Excavation and Installation

The trench for underdrains is excavated the same as that for culverts. If the bottom of the trench is unstable or in rock, the trench is excavated 6 in. (150 mm) deeper. The extra excavation is filled with gravel fill or aggregate similar to that used to fill the trench.

Underdrains are bedded and installed as below.

- If a perforated pipe is used, and the perforations are to be at the bottom of the pipe, a bed is made with 3 inches (75 mm) of the aggregate used to fill the trench. The aggregate is tamped true to line and grade.
- If the pipe used has a bell, the pipe is installed with the bell up grade and the spigot end entered fully into the adjacent bell.
- If clay or concrete pipe is used, the joints do not have to be filled with a joint sealant or fitted with a gasket.
- If metal, bituminized fiber, plastic, polyethylene or asbestos cement pipe is used, the pipe must be carefully butted together and held by bands or other approved means to prevent displacement of the joint.

2-421C Backfilling

After installation, aggregate is placed around and over the pipe to 12 in. (300 mm) above the top of the pipe. The remainder of the trench is filled with aggregate and tamped in layers as shown on the plans. If perforated pipe is used and the holes are upward or if sand is used instead of aggregate, a 3 in. (75 mm) layer of Size No. 8 (3/8-in.) aggregate is placed over the pipe and around all of the holes. Geotextile may be substituted for the 3 in. (75 mm) layer of aggregate. If geotextile is used, the entire length of the pipe is wrapped in the fabric. The fabric is lapped and welded or bonded. Where the seams of the fabric are not welded or bonded, the fabric must be lapped. For pipes 6 in. (150 mm) or larger, the lap must be equal to the diameter of the pipe. For smaller pipe, the lap must be at least 6 in. (150 mm).

In some instances, the Contractor's equipment may be of such capacity that the trench for the underdrain is wider than the designed width. The contractor may elect to fill the entire trench with aggregate. If the contractor elects to backfill the trench with earth to give the required cross section and place only the required amount of aggregate, the aggregate and earth must be separated by a layer of filter fabric. In either case, the earth or other material used as backfill outside the limits of the underdrain should be placed and compacted in the same manner as backfill for culverts.

If subbase material or gravel is to be placed over the underdrain, a 6 in. (150 mm) layer of the material must be placed immediately after the trench is filled.

Call Before You Dig regulations require the contractor to place warning tape 12 in. (300 mm) above an underdrain installation. The tape must be durable, designed to withstand extended underground exposure, green in color, and durably imprinted with an appropriate warning message. There is no additional pay for providing and placing the tape. Additional information about Call Before You Dig can be found in Volume 2, Chapter 3, "Excavation and Embankment."

2-422 Ditches and Channels

Ditches and channels of the specified type and cross section are to be installed where noted on the plans or ordered by the Engineer. Unstable soil conditions encountered in the field prior to actual ditch or channel construction should be referred to the Project Engineer for resolution. Gravel wedges, gravel blankets, or riprap with geotextile have been used effectively to stabilize wet slopes.

Chapter 5 - Base Courses

2-501 Subgrade

2-501A General

The subgrade is the part of the roadbed on which the pavement and shoulder structures are constructed. The pavement and paved shoulder structures include subbase, base and surface courses. The surface of the subgrade is the same grade as the bottom surface of the subbase.

Subgrade is covered in Section 2.09 of the *Standard Specifications*. The name of the pay item is "Formation of Subgrade." Formation of the subgrade involves shaping and compacting the existing embankments and excavations to the grade and cross slope shown on the plan cross sections, protecting the finished subgrade from damage, and maintaining subgrade drainage. Additional excavation and fill may be required during subgrade formation to achieve the correct density or stability, or to bring the subgrade to the correct line, grade and cross section.

The subgrade item may involve additional types of work. If the contract has no item for clearing and grubbing and no items for grading, the work of clearing waterways, ditches, drainage structures, and culverts is performed under the subgrade item. Clearing and grubbing work is covered in Volume 2 Chapter 3, "Excavation and Embankment." In addition, scarifying existing stone or gravel roads, if needed, shall be covered under the subgrade item.

2-501B Subgrade Construction Methods

Prior to forming the subgrade, grade stakes should be set by the contractor's survey party. The Inspector must ensure that the contractor sets the stakes needed to construct the subgrade to the required lines, grades, and cross section. Stakes must be set at least every 50 feet. The Inspector shall check grades transferred to the contractor's stakes. Any concerns regarding the contractor's stake grades vs. the plan grades shall be brought to the PE's attention immediately.

The contractor must test (QC) the compaction of the subgrade in accordance with the *Standard Specifications*. The Inspector should verify the compaction of the subgrade and the method(s) the contractor uses to check compaction (QA). The Inspector also makes a determination whether the subgrade is true to the required line and grade, and in the proper condition to receive the subbase, base and surface courses. All soft or yielding material and other portions of the subgrade which will not compact readily shall be removed and replaced with suitable material. The subgrade must be free of intermittent hard or soft spots, and must be uniformly compacted to the density called for in the *Standard Specifications*. The Contractor shall protect the completed subgrade from damage, and maintain proper drainage. It shall be checked by the Engineer prior to placing any pavement structure and shoulders thereon.

2-502 Subbase

2-502A General

Subbase is material placed on the floors of cuts or on embankments. The material consists of a clean soil-aggregate mixture of bank or crushed gravel, crusher-run stone, reclaimed miscellaneous aggregate, or a combination of these materials. Subbase is covered in Section 2.12 of the *Standard Specifications*.

The top surface of the subbase supports the pavement, shoulders, and related appurtenances. Additionally, subbase allows water to drain from beneath the pavement and intercepts the upward flow of water.

Because of its drainage characteristics, subbase helps prevent the formation of ice beneath the pavement and, consequently, helps prevent frost heaves and related problems.

The Inspector shall complete a Base & Bituminous Concrete Inspection Report ([Form CON-136](#)) each day that subbase material is used.

2-502B Subbase Construction Methods

Before any subbase is placed, the underlying material shall be graded and compacted to the required cross section to drain water that may reach the subbase – either from the top or from seepage from the underlying material. Unstable, yielding foundation material shall be removed and replaced with satisfactory embankment material or additional subbase, as directed by the Engineer. Care should be taken to match the characteristics of the additional material to those of the material in place to avoid creating a trap for water. After embankment grading is complete, the Inspector shall spot check the cross sections of the top surface before subbase material is placed and the final cross sections after subbase grading is complete. The Inspector shall contact District Survey, if needed.

If the required subbase thickness does not exceed 8 inches after compaction, the subbase may be placed in a single course. If the total required subbase thickness is 8 inches or more, the subbase shall be placed in courses not to exceed 6 inches each after compaction. The subbase shall be uniformly compacted, and achieve the dry density as specified in the *Standard Specifications*. The Contractor shall perform in-place density testing in a sufficient frequency to ensure that the specified results are continuously met. The “Minimum Schedule for Acceptance Testing,” in the [Materials Testing Manual](#) published by the Division of Materials Testing, includes information about sampling for subbase tests.

Because subbase may be placed intermittently and in varying thicknesses on different sections of the road, the Inspector must check its end points and points of change in depth to make sure that water will not be trapped. For example, where the mainline and a ramp or local road comes together, a constant depth is not always attainable because of different requirements or designer preferences. Figure 2-5.2 shows an example of underdrain placement that prevents trapping water where two different road sections meet.

If the cross sections do not show the subbase extending for the full width of the roadway, the Inspector should review whether means to drain the subbase should be provided by installing subbase to the outer face of the slope, also known as “daylighting.” An increase to the subbase item quantity should be brought to the attention of the Project Engineer.

In addition to serving as a drainage layer, the subbase itself exhibits minimal detrimental frost action, such as frost heaving or frost boils during a thaw. Both of these conditions are dependent on the subbase being “clean,” that is, having very little silt, clay or excessive fines. Bank-run material, such as natural gravel, must be closely watched to ensure compliance with the gradation requirements. Most gravel banks contain stratified courses of fine and coarse aggregate material. Blending the material to comply with the gradation requirements is the responsibility of the contractor. Unsatisfactory material must be removed and replaced with acceptable material.

Figure 2-5.2 Avoiding Water Entrapment

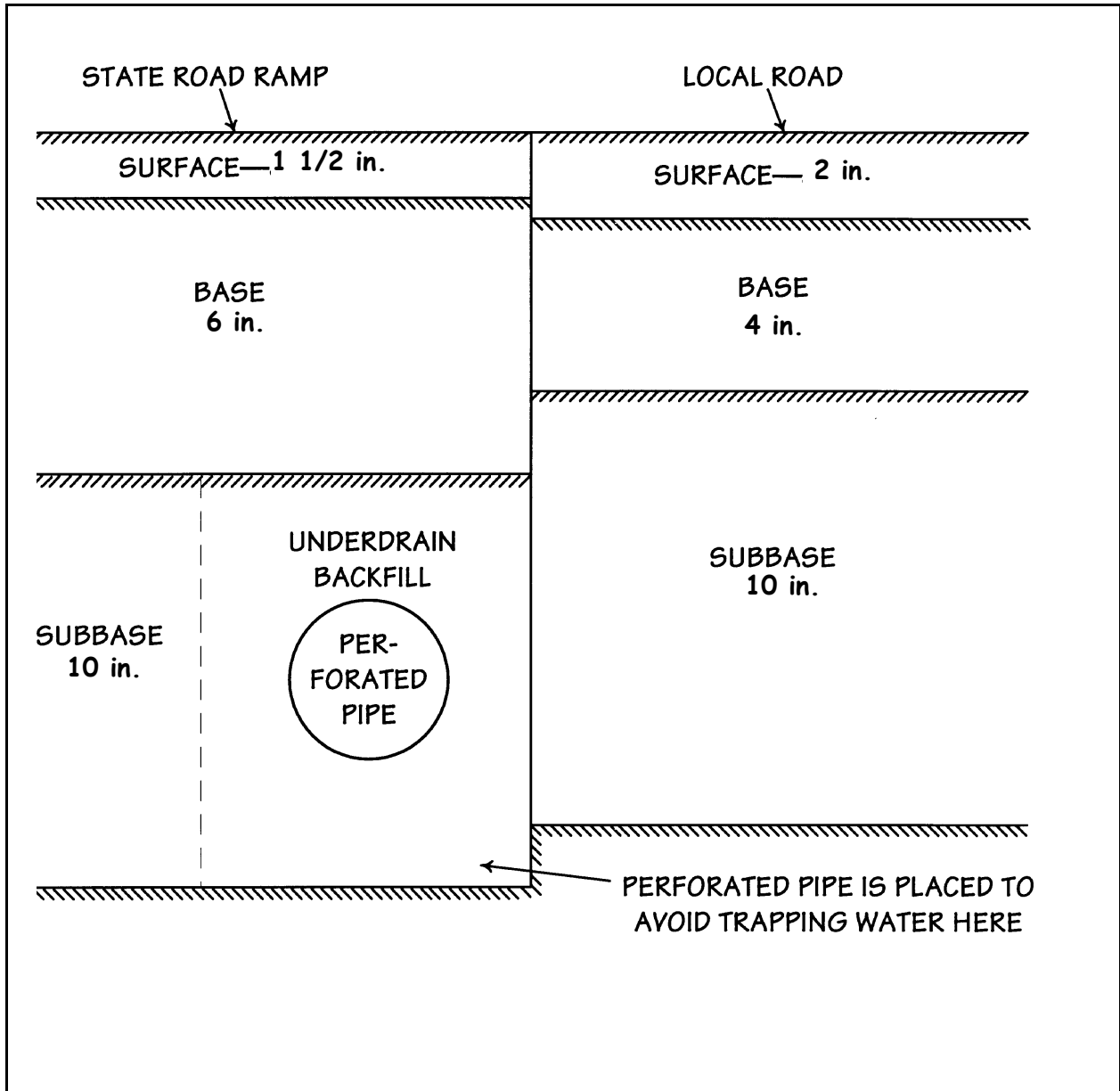

Required underdrains and outlets must be in place and functioning prior to any subbase placement. The underdrains and outlets help dry wet spots and prevent the subbase from being contaminated by churning and mixing with wet material underneath it. Should the subbase be contaminated by the foundation material below, it must be removed and replaced with clean material by the Contractor, with no additional compensation.

2-503 Base Courses

A base course consists of a layer or layers of material placed between the top of the subbase and the surface course of a pavement to provide economical, homogeneous and stable support. Base courses are

subjected to severe loading, and thus the materials must be durable enough to support and transmit these loads to the underlying roadway components.

Before any base course is placed, the subbase must be constructed according to the current *Standard Specifications*. As mentioned previously, the riding surface of the completed pavement is affected by irregularities in either subbase or the surface of the base course; therefore it is necessary for the Inspector to ensure that the contractor is conscientious in carrying out this phase of the work. The contractor is responsible for draining and protecting the subbase. No base material should be placed on a soft, loose, or frozen subbase.

Each day a base material is incorporated in the job, a Base & Bituminous Concrete Inspection Report ([Form CON-136](#)) shall be completed by the Chief Inspector.

Base courses include:

- Processed Aggregate Base
- HMA S1.0

The requirements for the sampling and testing of base coursed can be found in the “Minimum Schedule for Acceptance Testing,” in the [Materials Testing Manual](#) published by the Division of Materials Testing.

2-504 Processed Aggregate Base

2-504A General

The material for processed aggregate base is a mixture of coarse and fine aggregate. The coarse aggregate shall consist of gravel, broken stone, or reclaimed miscellaneous aggregate, at the contractor's option. However, only one type of coarse aggregate shall be used on a project unless specifically permitted by the Engineer. The fine aggregate shall consist of natural sand, stone sand, screenings, or any combination thereof. Processed aggregate base is covered in Section 3.04 of the *Standard Specifications*.

2-504B Processed Aggregate Base Construction Methods

Prior to placing the base, the prepared subbase must be maintained true to line and grade for a minimum distance of 200 feet in advance of the spreading operation. Aggregate courses shall not be placed more than 500 feet ahead of the compaction and binding operation on that particular course.

The processed aggregate base shall be spread uniformly by a method approved by the Engineer. Only approved spreaders or stone boxes shall be used. Power graders shall not be used unless approved by the Engineer. Rollers shall deliver a ground pressure of not less than 300 lbs./inch of contact width and shall have a weight not less than 10 tons. Vibratory units shall have a static weight of not less than 4 tons. If water is used during compaction and binding, it shall be applied from an approved watering device.

The thickness of each course shall not be more than 4 inches after compaction. The compacting and binding operation shall start at the outside edges, overlapping the shoulder for a distance of not less than 6 inches, and progress toward and parallel to the centerline. The work shall cover the entire surface, each pass overlapping the preceding by a uniform amount. In areas of superelevation and special cross slopes, the operation shall progress from the low edge to the high edge. There shall be at least four complete passes of the compaction and binding operations. The operation shall continue until the voids in the surface are reduced to provide a firm and uniform surface, to the satisfaction of the Engineer. The top course shall be spread, compacted and bound in the same manner as the bottom course, such that the combined thickness is as planned. The dry density shall be as specified in the *Standard Specifications*. The Contractor shall perform in-place density testing to ensure the specified results are met.

If the processed aggregate base becomes contaminated with the subgrade and subbase material below, the Contractor shall remove the mixture without additional compensation. They shall add new subbase material if required, and reshape and recompact. New base material shall be added, compacted and bound, as hereinbefore specified.

2-505 HMA S1.0

This hot-mixed asphalt (HMA) material consists of a graded mixture of coarse and fine aggregates, mineral filler if necessary, and asphalt cement produced in a plant in accordance with an approved job mix formula. Section 4.06 of the *Standard Specifications* and Chapter 2-6, "Bituminous Pavements," cover bituminous concrete. A paving machine with automatic grade controls should be used when placing HMA S1.0.

2-505A Pavetrack

Pavetrack is a network-based application that is used to notify the Division of Materials Testing (DMT) when Construction and Maintenance projects have paving scheduled so that the plant where the material is being produced and the paving operation itself can be scheduled for inspection during production. This application does away with the need for Construction project personnel to make a phone call to the DMT the evening prior to paving to schedule inspections. Construction and Maintenance project personnel must input information into the application when they are aware of the paving schedule no later than 3 p.m. the preceding day. For paving at night, a two day notice is preferred. Information such as estimated quantity, supplier, location, and time of paving is required. DMT personnel will use this information to prioritize and schedule field and plant inspectors for the following 24 hours.

Following paving, project personnel must document how many tons of bituminous material(s) were placed. Cancellations will be identified with a "0" quantity in the actual tons used field. Density results from core samples and Deficiency status will also be posted in Pavetrack.

Chapter 6 - Bituminous Pavements

2-601 Bituminous Concrete (HMA) Pavements

2-601A General

Bituminous Concrete, also referred to as Hot Mix Asphalt (HMA), pavement consists of coarse or dense graded hot mixed, hot laid, bituminous paving mixtures. Bituminous Concrete mixtures are placed on either a prepared gravel base, on new pavement structures or an existing pavement structure for overlay projects. Bituminous Concrete mixtures are composed of carefully graded coarse and fine aggregates, mineral filler when necessary, and asphaltic cement.

Section 4.06 may be a Standard Specification, Supplement or a Special Provision. It is important for inspectors to determine which Specification is in the contract, review and be familiar with its specific requirements.

2-602 Bituminous Concrete Mixes and Applications

2-602A Dense Graded Mixes

Superpave mix designs have replaced Marshall Mix designs in all cases. Superpave mixes are designated as “HMA S*.” Where “S” indicates Superpave and * indicates the sieve related to the nominal maximum aggregate size of the mix, i.e. HMA S0.5. The DOT incorporates two (2) design levels for each nominal maximum aggregate size into State projects. The levels used are based on the amount of traffic loading the pavement will be exposed to during its designed life. A local road, for example, would typically be a level 2. An interstate highway would typically be a level 3. Level 1 is reserved for municipalities and is not used on State projects.

The design level has no bearing on the nominal maximum aggregate size. For example, a HMA S0.5 level 2 and a HMA S0.5 level 3 have the same nominal maximum aggregate size: 0.5 inch (12.5 mm).

Typical usage for Superpave mix designs:

HMA S0.25 -	Leveling course, thin lift maintenance overlays, over milled surfaces, bridge membrane systems. Recommended compacted lift thickness: 1 inch (25 mm)
HMA S0.375 -	Ideal as a surface course for local roads and some secondary roadways, leveling course, wedge course, over milled surfaces, certain bridge membrane systems, good for some limited access highways. Recommended compacted lift thickness: 1.5 inches (38 mm)
HMA S0.5 -	Ideal surface course for all types of roadways including limited access highways and other higher volume roadways, also good for many wedge course applications. Recommended compacted lift thickness: 2 inches (50 mm)
HMA S1 -	Base course, thick leveling courses Recommended compacted lift thickness: 3 to 4 inches (75 to 100 mm)

CT DOT’s standard Superpave HMA mixes use a “neat,” unmodified PG 64-22 asphalt as the binder. When increased durability, strength, crack or rut resistance is desired, the liquid asphalt binder can be

modified to enhance its properties and hence enhance the overall properties of the bituminous concrete mixture. The most common form of modification to enhance the properties of the liquid asphalt is to add polymer. The current standard polymer modification requires a styrene-butadiene-styrene (SBS) polymer to be added to produce a polymer modified PG 76-22 binder.

Generally PMA mixes will be specified for roadways with higher volumes including higher truck traffic percentages. Because of the added polymer they are stiffer overall and more difficult to place and compact. Because of this, it is a mandatory mix design requirement for PMA mixes that a warm mix (WMA) additive/process be added to reduce production and placement temperatures and increase mix workability to aid in achieving compaction.

Typical usages for polymer modified asphalt (PMA) mix designs:

PMA S0.25 - Ideal as a leveling course for high volume roadways requiring increased durability and resistance to rutting or reflective cracking. It may be used as a thin binder course placed under an ultra-thin surface treatment for higher volume roadways. It may be used as the first lift placed over bridge membrane systems on higher volume roadways.

Recommended compacted lift thickness: 1 inch (25 mm)

PMA S0.375 - Ideal as a surface course for local and secondary roadways requiring increased durability and resistance to rutting or reflective cracking. It may be used as a leveling course, wedge course or as a first lift over certain bridge membrane systems.

Recommended compacted lift thickness: 1.5 inches (38 mm)

PMA S0.5 - Ideal as a surface course for all roadways requiring increased durability and resistance to rutting or reflective cracking. Also used as the primary surface course on secondary and local roadways requiring enhanced mix properties to provide greater resistance to rutting, cracking, and raveling. It may be used as a binder course and for thicker wedge course applications when enhanced mix properties are required.

Recommended compacted lift thickness: 2 inches (50 mm)

PMA S1.0 - Ideal as a thick base or binder course on higher volume roadways requiring increased strength and resistance to rutting or fatigue cracking.

Recommended compacted lift thickness: 4 inches (100 mm)

2-602B Gap Graded Mixes

Gap graded mixes typically contain a higher percentage of coarse aggregates and less mid-sized aggregates than dense graded mixes. This allows more room in the aggregate structure for asphalt and therefore higher amounts of effective asphalt can be added to the mix. This increased asphalt film thickness provides greater long term durability of the mix. The coarser gradation also results in greater pavement surface macro-texture. This greater macro-texture increases wet weather skid resistance, improves wet weather visibility, and greatly reduces hydroplaning potential. In addition, these pavements are typically quieter than dense graded pavements as they generate less “tire-snap” and tend to absorb some of the sound into the texture of the pavement.

Ultra-Thin Bonded HMA is a type of gap graded mix that is hot bonded to the underlying pavement with a heavy application of polymer modified tack coat. The most common type used in CT is “Type B” which has a maximum nominal aggregate size of $\frac{3}{8}$ of an inch and is typically placed at $\frac{5}{8}$ of an inch thick. A special “spray paver” is required to place this mix.

Typical usage of Ultra-Thin Bonded HMA:

- Ideal as a durable ultra-thin (<1” thick) surface wearing course that can be placed on any volume roadway.
- To be used in areas requiring superior wet weather friction and/or to reduce hydroplaning potential.
- Can be used in areas that are sensitive to roadway tire noise. Specifically, Ultra-Thin Bonded HMA- (Type B) is the most effective at reducing pavement tire noise.

2-603 Contract Specifications

The *Standard Specifications for Roads, Bridges and Incidental Construction* (commonly called the *Standard Specifications*) and the Special Provisions (Sections 4.06 and M.04) contain the information regarding material specification, methods of construction, methods of measurement, and basis of payment by which the contractor and the State are bound to in the performance of the contract work.

The contractor is required to submit Quality Control Plans (QCP) 30 days prior to any paving for review and approval. There are two QCP’s required, one for production and one for placement. The requirements for the Production QCP are found in Special Provision Section M.04. The requirements for the Placement QCP are found in Special Provision Section 4.06. The Production QCP is reviewed and approved by the DMT and the Placement QCP is reviewed and approved by the Office of Construction (OOC). Once the QCP’s are approved they are valid for all projects within the calendar year in which they were submitted.

2-604 Contract Plans

Contract plans provide information related to pavements for roadways. This information includes:

- The typical roadway cross sections describe the location, thickness of pavement, width of pavement and specific Bituminous Concrete mixture(s) to which the roadway is to be constructed.
- The plan sheets provide a visual description of the roadway. These plans also describe the roadway pavement width at specific locations by station.
- The cross sections provide information regarding finish pavement line and grade by station. The maximum thicknesses for bituminous concrete are shown on the typical cross sections.

When a Bituminous Concrete wearing surface is applied to a bridge deck, the slab plan and the miscellaneous details sheets in the bridge plans describe the Bituminous Concrete mixture and thickness of the overlay to be placed on bridge decks.

2-605 Production Responsibility

Bituminous Concrete mixtures consist of coarse aggregate, fine aggregate, mineral filler if necessary, and asphalt cement combined to meet composition limits by weight and other characteristics as described in Special Provision Section M.04. Proportioning of the materials, within the composition limits specified, is the responsibility of the Contractor or Producer. Approval of the source of all materials is required before such materials can be used. The Contractor or Producer must submit a job mix formula for each Bituminous Concrete mix design to be produced to the Department’s Material Testing Laboratory for

approval. When the job mix formula is approved, the Contractor is required to furnish a mixture that complies with the formula within the tolerances as described in Special Provision Section M.04.

Changes in the source of supply require approval by the Department's Material Testing Laboratory, and may require adjustment of the job mix formula by the Contractor. The Chief Inspector, prior to any paving, must obtain copies of the approved job mix formula from the Laboratory testing representative. One copy is kept in the project files, and the other copy is kept by the Paving Inspector at the paving site.

2-606 Inspection Responsibilities

The responsibilities for acceptance inspection, sampling and testing are split between the Department's Material Testing Laboratory and the District personnel.

2-606A Material Testing Laboratory

The Principal Engineer, DMT is responsible for providing the personnel required to examine and approve the Contractor's mixing plant and the trucks used for transporting the Bituminous Concrete mixes to the project.

2-606B District Responsibilities

The Assistant District Engineer assigns the Project Engineer and inspection personnel required to receive the bituminous materials, inspect the trucks used for transporting the bituminous materials upon arrival to the site and inspect the placement of the materials in accordance with the contract specifications at the paving site on the project.

2-606C Preliminary Inspection and Approval of Plant

Plant equipment used for the production and transportation of bituminous concrete must conform to the requirements of Special Provision Section M.04 in the contract. Inspection, approval and certification that the plant is equipped in conformance with the requirements of the contract specifications are the function and responsibility of the Principal Engineer, DMT.

Upon receipt of the Contractor's report of Anticipated Source of Materials, the Principal Engineer, DMT, will arrange for the inspection of the equipment at the plants selected to supply Bituminous Concrete. The DMT will notify the District Engineer of the results of the inspection. Requirements for plant inspection can be found in the manual for the DMT.

2-606D Pavetrack

The inspection staff must use the Pavetrack system as a means of notifying both District and the DMT personnel of paving events. Inspection staff can request access to Pavetrack by contacting the DMT.

Prior to each paving event, the Chief Inspector should log in to Pavetrack and create an entry for the paving event. The entry will include:

- Mixing plant
- Mix type
- Estimated tonnage
- Date of placement
- Start time

A comment box is included for each entry. The Chief Inspector may use the comment box to enter any information they deem necessary, such as contact information, cancellations, additional mix information, paving location, etc.

Pavetrack entries must be entered in a timely manner so that the DMT has adequate time to schedule personnel for production testing. The entry should be made no later than midafternoon of the business day preceding the paving event. Upon completion of the paving event for each entry made for a job, the inspector should enter the actual tonnage placed for that entry. If paving was cancelled for that entry, zero should be entered.

2-607 Inspection Prior to Paving

The Paving Inspector must perform the following checks prior to the start of paving:

2-607A Paving Equipment

Before paving is started, all paving machines, longitudinal joint devices, material transfer vehicles (MTV), rollers and lighting equipment (for night work) must be inspected and approved for conformance with Specifications by the Paving Inspector or another assigned inspector. The Inspector should be sure that sufficient equipment, in good working order, is available so that once paving starts it can be continued without undue delays and shutdowns.

2-607B Paving Machines

Most Bituminous Concrete mixtures are placed with a paver. The paver spreads the mixture, in either a uniform layer of a desired thickness or a layer of variable thickness to achieve the desired elevation and cross section, ready for compaction.

The paver consists of two basic units: a tractor and a screed. The tractor receives, conveys and augers the mixture to the screed and propels the screed forward. The tractor may be mounted on either rubber tires or tracks. In addition to the engine, the tractor unit has a hopper for receiving the mix from the haul trucks, conveyors to move the mix through the flow control gates to the augers, flow gates to prevent overloading the augers, and augers to evenly spread the mix in front of the screed. Rollers are mounted on the front of the tractor to push the haul trucks during the dumping process. The rollers should turn freely so the trucks will have little effect on paver operation.

The screed performs the actual placing of Bituminous Concrete material to the desired width and thickness or elevation, as shown in the sketch in Figure 2-6.3. It is towed by the tractor and is free to float up or down until the bottom of the screed is parallel with the grade over which it is traveling.

Figure 2-6.1 Typical Bituminous Paver- side view

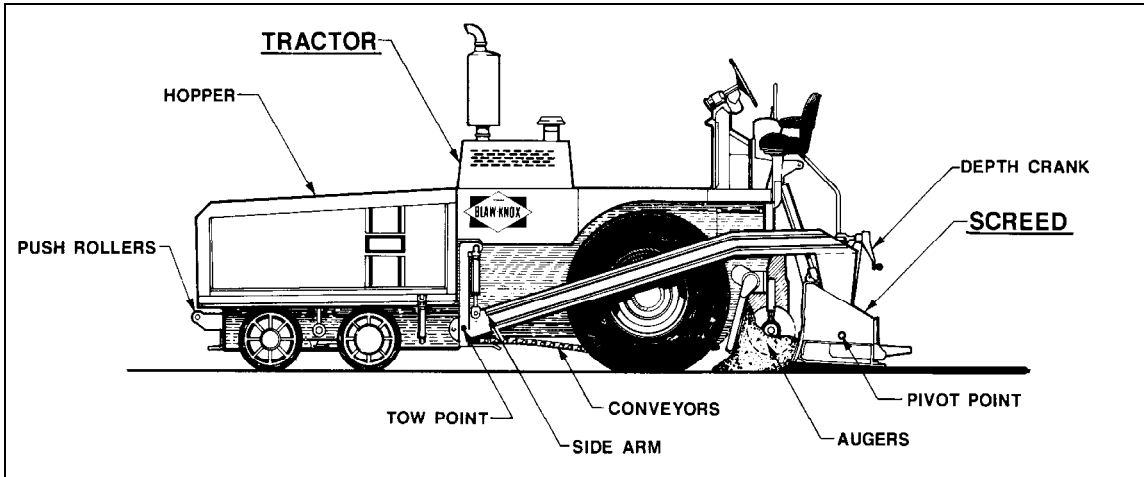
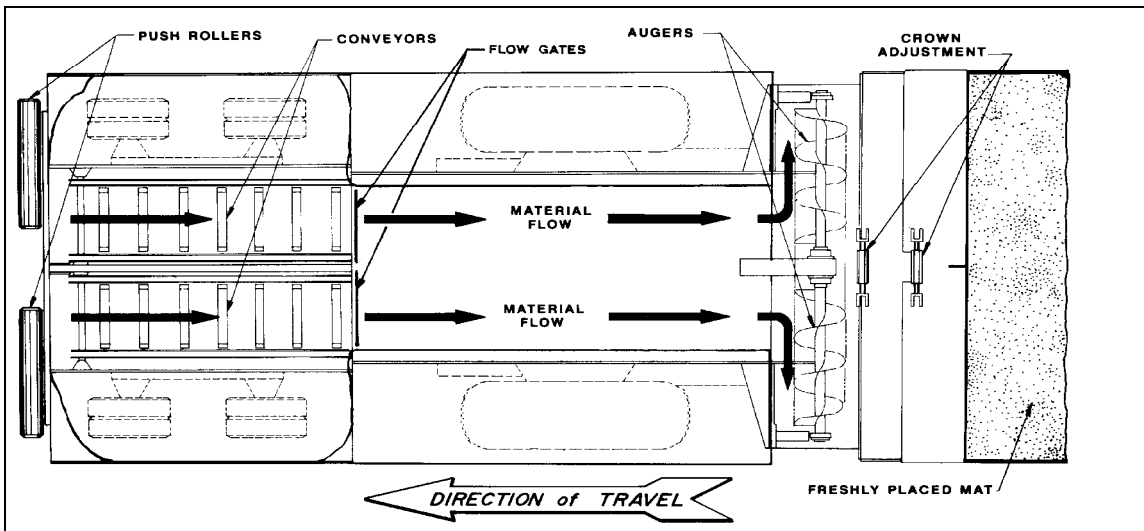
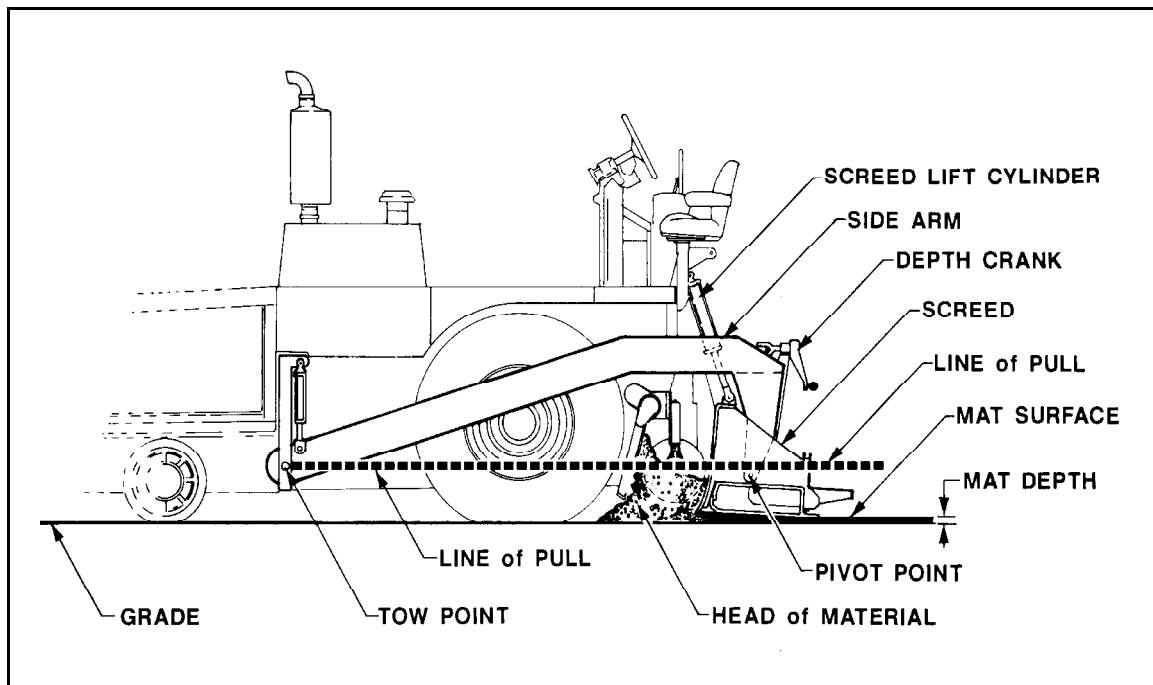

Figure 2-6.2 Typical Bituminous Paver- top view



The relationship between the vertical movement of the screed tow point and the elevation of the screed is the key to the paver's ability to lay smooth pavements. There is an 8-to-1 ratio so that a 1 in. (25 mm) vertical movement of the tow point will result in only a $\frac{1}{8}$ in. (3 mm) vertical corrective movement of the screed, and before that $\frac{1}{8}$ in. (3 mm) movement is accomplished, the paver must move 5 times the length of the screed arm.

Figure 2-6.3 Screed Details



Because of the free-floating principle, the screed does not reflect any of the minor bumps and dips in the existing grade – resulting in a smoother pavement. An exaggerated view of the leveling action of a paver is shown in Figure 2-6.4.

Pavers must be equipped with automatic grade and slope controls as specified in the Special Provision Section 4.06 in the contract. The automatic screed controls can be set for automatic, semiautomatic or manual automatic operation on most pavers. Automatic screed controls typically have these main components:

- Grade sensor,
- Slope sensor,
- Control station, and
- Slope control.

The grade sensor rides on a string line, contact ski, sonic grade beam or a joint matcher to detect changes in elevation and transmits the information electronically to the controls. The electronic controls can be checked by varying the position of the grade sensor and observing if the screed controls react to make the correct adjustments. When the contact ski is used, the grade sensor should always ride on the center of the ski so that all elevation changes are averaged.

Use of the automatic controls further enhances the paver's capability to produce a smooth pavement surface regardless of irregularities in the surface being paved. Slope – crown or super-elevation – is controlled by the slope sensor or pendulum set for the desired slope. Once the screed is set for the desired mat thickness and slope, the automatic controls activate the motors or cylinders to change the screed tilt to automatically compensate for road surface irregularities.

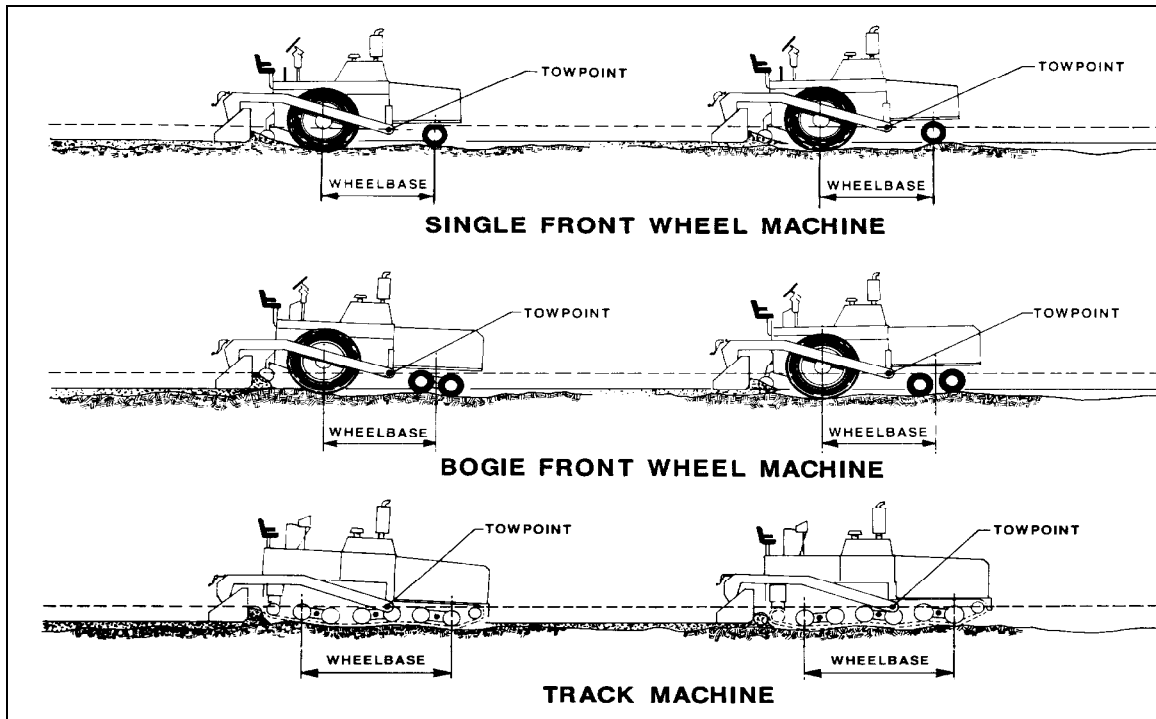
Figure 2-6.4 Paver Leveling Action**2-607C Rollers**

There are four types of rollers used to compact Bituminous Concrete pavements: double drum tandem (static), vibratory double drum, oscillatory/vibratory double drum and pneumatic tire. Vibratory and oscillatory rollers are capable of operating in static or dynamic modes. Vibratory and oscillatory rollers use dynamic forces to aid in the compaction of the Bituminous Concrete.

Rollers using the vibratory system achieve compaction through vertical amplitude forces. Rollers with this system shall be equipped with indicators that provide the operator with amplitude, frequency and speed settings/readouts to measure the impacts per foot during the compaction process.

Rollers using the oscillatory system achieve compaction through horizontal shear forces. Rollers with this system shall be equipped with frequency indicators. Rollers can operate in the dynamic mode using the oscillatory system on concrete structures such as most bridges if at the lowest frequency setting. Inspectors should verify the structure is rated for such compaction systems.

All rollers must have proper sprinkling systems to wet the drums or tires to prevent the mix from sticking. Scrapers are usually required on drum rollers. Rollers must be equipped with drip pans to prevent oil, grease, or fuel from dropping onto the roadway due to the deleterious effects petroleum products have when contacting bituminous pavement. Clutches must function smoothly; a roller that jerks when starting, stopping or reversing will contribute to a rough surface.

The tires on pneumatic-tire rollers are typically arranged so the gaps between the tires on one axle are covered by the tires on the other as shown in Figure 2-6.5. The Contractor is required to furnish evidence regarding tire size, pressure and loading to confirm that the proper contact pressure is being developed and that the loading and contact pressure are uniform for all wheels.

Figure 2-6.5 Tire Arrangement—Pneumatic-Tire Rollers

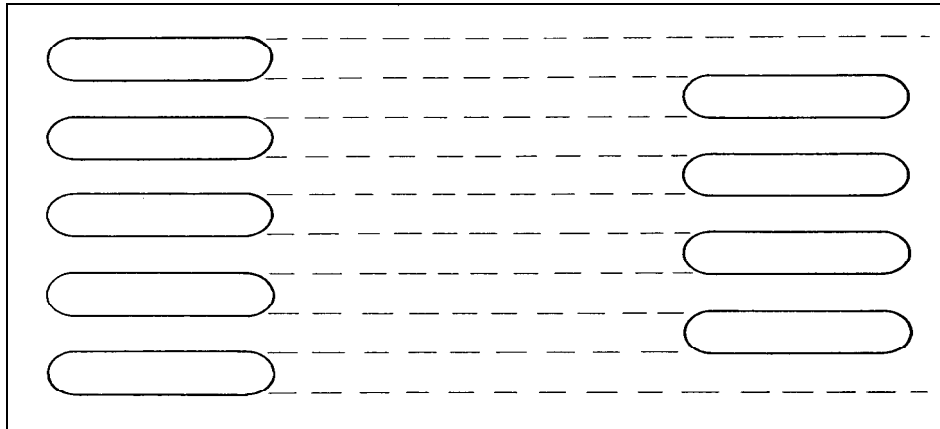

2-607D Material Transfer Vehicle (MTV)

A Material Transfer Vehicle (MTV) shall be used when the conditions of Special Provision Section 4.06 in the contract are met. See Figure 2-6.6.

A Load and Resistance Factor Rating (LRFR) analysis should be obtained from the Designer for all structures that the MTV may be required to traverse during the paving operation. See Form 2-6.31 for a sample letter to Design from the Project Engineer requesting the analysis.

Figure 2-6.6 Typical Material Transfer Vehicles (MTV)

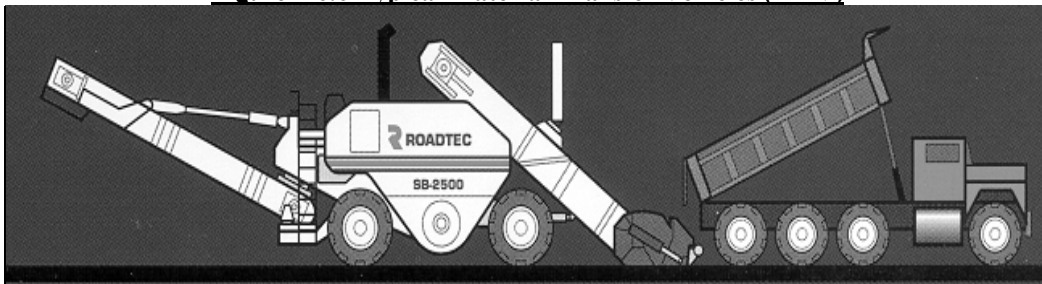

2-607E Lighting

Adequate lighting is required for night paving. The Inspector must check the lighting equipment before paving begins to ensure that it complies with specifications and is functional. Continuing checks must be made during paving to ensure that lights continue to function.

2-608 Base Preparation

Bituminous Concrete may be placed:

- over existing pavements, either bituminous or concrete,
- on newly constructed aggregate or bituminous base courses, or
- for widening projects, on a combination of existing pavement and base course.

The existing surface must be compact, stable, and free of all debris (millings, sand, mud, leaves, etc.) before placing the new bituminous pavement. This may involve patching, leveling, wedging, and cleaning. Inspect the surface for potholes, base failures, dips, bumps, cracks or other defects, and arrange for corrections. Check the prepared subgrade or base course for compaction and proper line, grade and cross slope as detailed in the plans. Many of the distresses that eventually appear in the surface of a pavement are the result of inadequacies in the subgrade or base.

Gravel subbase must be dry and all defects corrected. The entire base should be compacted for a distance of 2,000 ft. (600 m) ahead of the paving operation.

2-609 Utilities

Where there are underground utilities, a determination must be made as to whether vibratory compaction equipment will damage the utility. Close coordination with the utility companies is essential. Density specifications are not waived if vibratory compaction is not possible. Alternate methods of compaction, like pneumatic tire or oscillatory rollers, must be used.

The Inspector must note all overhead obstacles such as utility power lines, guy wires, traffic signals, bridge overpasses, and overhead signs. Overhead obstacles must be clearly marked or flagged so that paving equipment operators and truck drivers will not hit them. The marking of such obstacles should be done only by the appropriate utility company. The Inspector should inform the Contractor of these obstacles to avoid any possible conflicts and to maintain safe and adequate distances between equipment and the obstacles. Dump truck drivers must be especially careful of overhead obstacles when raising truck bodies.

Utility companies that have facilities located within the highway right-of-way that will be affected by a paving project must be notified at the start of the project, well before paving is scheduled. (Agreements with the utilities for any adjustments should be obtained prior to start of construction. Utilities should be invited to attend the preconstruction meeting.)

When the utility company does not return the agreement in a reasonable period of time or fails to appear at the preconstruction meeting, a certified letter must be sent to that utility company before the paving is to commence, advising them of the start date and that the utility location will be marked. It is very important that the Department attempt, in every way possible, to have the utility companies on the site during the paving operation. Where utilities have not adjusted their facilities prior to paving, the Paving Inspector must notify the District Office before allowing paving to commence.

2-610 Pre-paving Meeting

A pre-paving meeting should be held in advance of the actual start of paving. It is normally held at the project site.

The pre-paving meeting should be scheduled so the Contractor's paving foreman, who will supervise the actual paving operation, can attend. The paving foreman will then understand the project and can assign the proper equipment to perform the work as specified. The pre-paving meeting agenda is shown in Form 2-6.1 in the appendix at the end of this chapter. The Contractor's approved Quality Control Plan (QCP) should be discussed at the meeting.

Seasonal Requirements: The Seasonal Requirements are described in Special Provision Section 4.06 in the contract. This article should be carefully reviewed if any paving will take place on or after October 1st.

2-611 Test Section

The Contractor may be required to place a test section whenever the requirements of Special Provisions Section 4.06 or M.04 in the contract are not met.

2-612 Traffic Control

Where public traffic must be maintained through a paving operation, a proper signing pattern must be in place in accordance with the contract item "Maintenance and Protection of Traffic" prior to beginning the paving. Safety is the most important factor in any construction activity.

The traffic pattern must accommodate the traveling public, Contractor personnel and inspection forces. Inspection forces include those sampling and testing material. Maintaining an uninterrupted traffic flow so the paving operation proceeds without excessive delays is one of the key factors in attaining a superior quality paving project.

2-613 Inspection during Paving

2-613A The Day Before

Inspection staff should notify the District Office the day before a paving operation so any necessary arrangements can be made. The required paving information should be entered into Pavetrack as described in Volume 2 Section 2-606D.

2-613B Transportation of Mixture

Transportation of mixture shall meet the requirements of Special Provision Section 4.06 Article 4.06.03 in the contract.

Inspection of hauling equipment is the responsibility of the Contractor. The Paving Inspector, however, should check each truck when it arrives at the work site and reject the load if the truck does not conform.

All vendors producing Bituminous Concrete for the State under the terms of the contract must have their truck weighing scales, storage scales, and the mixing plant automated to provide a detailed delivery ticket to the Inspector for each batch, at the paving site for each load of material delivered.

A delivery ticket must accompany each load of mix transported to the project and must include the exact information specified in Special Provision Section 4.06 Article 4.06.03 and as shown in Volume 2, Section 2-632D.

2-613C Paving Inspection

At least one Paving Inspector must be present at all times that a paving operation is underway. The Contractor shall perform all quality control sampling and testing, provide inspection, and exercise management control to ensure that Bituminous Concrete production and placement conforms to all requirements. The Inspector provides quality assurance.

The Paving Inspector is responsible for receipt and placement of the material. Control of the shipment of materials is the responsibility of the supplier. Close communication between the Plant and Paving Inspector is essential. The Paving Inspector should advise the Contractor immediately if bad weather or other unsatisfactory conditions at the job site require the suspension of paving operations. Delays in stopping the trucks may result in wasted material.

The Paving Inspector is personally responsible for collecting the delivery tickets and signing each ticket prior to unloading, to assure that the material is actually incorporated in the work. Never allow Contractor personnel to collect the tickets.

The Inspector should frequently check the temperature of the mix in the trucks and at the paver, by use of a verified probe type armored thermometer or an infrared thermometer. Probe type thermometers must be verified by the DMT. Any loads not within the temperature requirements of the specifications must be rejected. Rejection of mixture based on temperature will only be allowed if confirmed by means of a probe type thermometer.

The Inspector should visually check each load to determine that the load is satisfactory. Mistakes in batching and mixing can occur at the plant without being noticed by the Contractor. The Paving Inspector should be especially vigilant in watching for certain characteristic behaviors of the mix which indicate trouble:

- An overheated or burned batch will give off a cloud of blue smoke and the mix will have a brown, dead appearance.
- If the asphalt has drained off or flowed to the bottom of the truck and the aggregate on top is uncoated, it could indicate the aggregate is dirty or wet.
- Excess asphalt in the mix will flush to the surface during rolling, and will appear fat, greasy and soupy.
- Excessive asphalt will also cause the mix to lie flat in the truck rather than dome up.
- Aggregates not dried sufficiently will cause the asphalt to puddle and the mix to be flat in the truck, and drops of water may appear dripping from the tailgate.
- Ensure that each truck dumping into the paver leaves empty.

Any change in the character of the mix, either in the trucks or as it is being placed, should be reported immediately to the Contractor or paving foreman so the condition can be corrected. The Inspector should watch for segregation in the mix. Segregation can be caused by improperly stockpiling aggregate so the larger stones roll to the bottom of the pile or by improperly loading the mix into the trucks at the paving plant. The preferred method of loading tandem-axle or tri-axle dump trucks is shown in Figure 2-6.8. About 40 percent of the mix is loaded in the center of the front half of the truck bed. The truck is then moved forward so the next 40 percent or so of the mix is deposited in the center of the back half of the bed. The truck is then moved backward so the remaining mix can be placed between the first two piles.

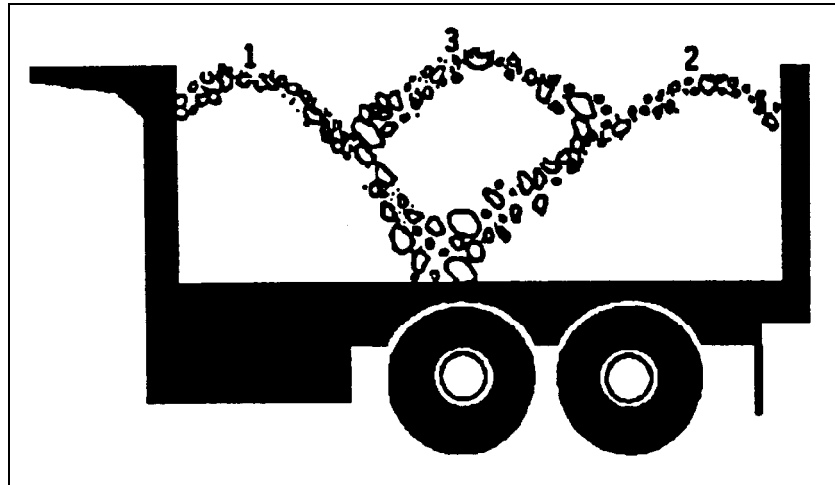
Figure 2-6.8 Preferred Truck Loading Sequence

The reason for rejection of any load must be recorded on the ticket and on the paving reports, so that proper deductions can be made from the pay quantities.

The Bituminous Concrete mixture shall not be placed whenever the surface is wet or frozen. No Bituminous Concrete mixes shall be placed when the air or base temperature is below the minimum temperature specified in Special Provision Section 4.06 in the contract.

The Paving Inspector must be sure that all of the necessary preliminary material tests have been made and that all the tests required in the “Schedule of Minimum Requirements for Test” are submitted as paving continues. The Contractor is responsible for tests at the plant.

Additional paving inspection information can be found in Special Provision Section 4.06 in the contract.

2-614 Tack Coat

A tack coat is the application of asphalt material to ensure a bond between newly placed Bituminous Concrete mixtures to varying contact surfaces. Tack coat application requirements can be found in Special Provision Section 4.06 in the contract.

Tack shall be applied uniformly without streaking or puddling. If a nozzle is not spraying properly, stop the distributor immediately and have the nozzle cleaned or adjusted. Where streaking occurs, direct the Contractor to make the necessary adjustments to eliminate the condition. Any puddles of tack coat material must be cleaned up before placing the mix. If it is allowed to remain, it will cause bleeding into the mix creating a “fat” spot- an area with an excessive amount of asphalt.

The height of the spray bar shall be such that a double overlap is achieved, see figure 2-6.9. The effects of having the spray bar too high or too low are excessive overlap or no overlap as shown in Figure 2-6.10.

The distributor must be capable of applying the tack coat material in accurately measured quantities and the specified rate of application.

Figure 2-6.9 Spray Bar Overlaps

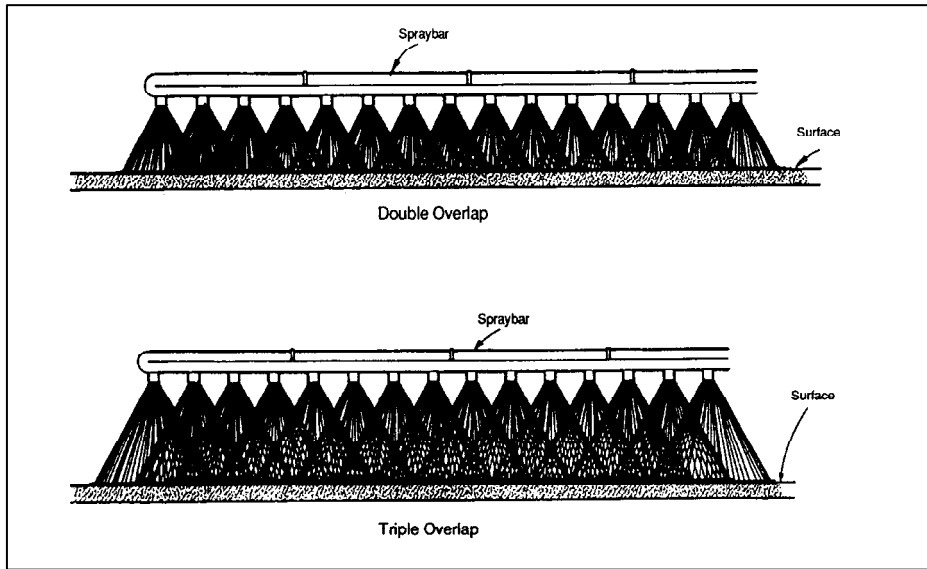
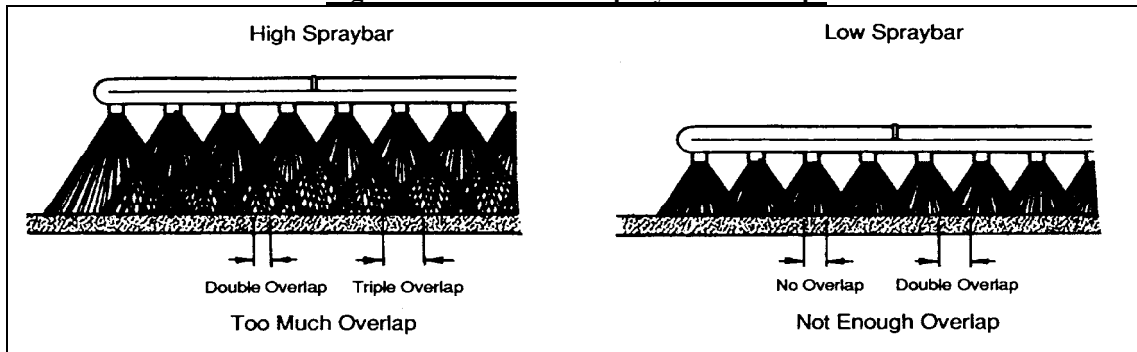

Figure 2-6.10 Incorrect Spray Bar Overlaps



Areas inaccessible to the spray bar should be tacked with a hand sprayer. Extreme care must be taken with a hand sprayer to get uniform coverage without puddling.

2-615 Mechanical Spreading

The basic principle of all mechanical spreaders – the paving machine – is the same. The machine consists of a self-propelled tractor and a screed unit. The tractor unit provides the motive power and includes the receiving hopper, the conveyor and spreading augers.

2-615A Screed Unit

The screed unit is attached to leveling arms that extend from the tow point on the tractor unit. See Figures 2-6.1 through 2-6.3 and 2-6.11. The tamper, screed depth cranks, crown controls, screed heater and the screed itself are all part of the screed unit. The screed rides on the finished surface. Pavers are required to have and use vibrating screeds to partially compact the mix as it is placed.

The spreading augers are worm screws that uniformly spread the mix across the full width of the machine. Each side of the machine is equipped with a feeder and auger unit, which can be operated simultaneously or

independently. The gates in the back of the hopper can be adjusted so there is a constant flow of material coming to the augers. The material around the augers should just cover the auger shaft.

The tamper bar is located on the front of the screed and is a vertical plate with an inclined face, facing toward the front end of the machine. The tamper bar provides the initial compaction to the mix. The vertical travel of this bar is about $\frac{1}{8}$ in. (3 mm) at approximately 1,200 strokes per minute. The tamper in its lowest position is about $\frac{1}{64}$ in. (0.4 mm) below the bottom of the screed. This fixes the surface elevation of the pavement just before the screed slides onto it. The real tamping is done by the front of this bar and will ensure uniform compaction.

The screed unit imparts the smooth riding quality to the pavement. It is adjustable to obtain the desired crown or cross slope in the pavement and must be set before paving is begun.

The thickness of the course is set before the paving begins by setting the screed to the desired height. The screed should be raised an additional 10 to 20 percent of the required depth to allow for the additional compaction by rollers behind the paver. After a short run of about 20 ft. (6 m), the depth of the material being placed should be checked. Any required adjustments to the thickness are made by the Contractor turning the thickness control levers. These levers are located on the screed unit, and are turned to the right to increase the depth of the material being laid and to the left to decrease it. The most important thing to remember in adjusting thickness controls is not to move the control more than $\frac{1}{4}$ turn at a time; otherwise the machine does not have time to act and variations in the level of the surface will result. Once the thickness of the material being laid is satisfactorily set on the machine, there should be very little reason to touch the screed depth cranks, and the Inspector should discourage workers from constantly adjusting them.

Controlling the vertical position of the free-floating screed, with respect to the grade surface over which the paver is moving, is the primary element in producing high-quality pavements. Factors such as paving speed, head of material, mix consistency, pre-compaction and screed angle all influence the vertical position of the screed. If any of these factors are varied during the paving operation, the variation will cause a change in the mat depth, density and/or texture. The three primary variable factors that influence the vertical position of the free-floating screed are listed below and shown in Figure 2-6.11.

Figure 2-6.11 Factors That Influence the Vertical Position of the Screed

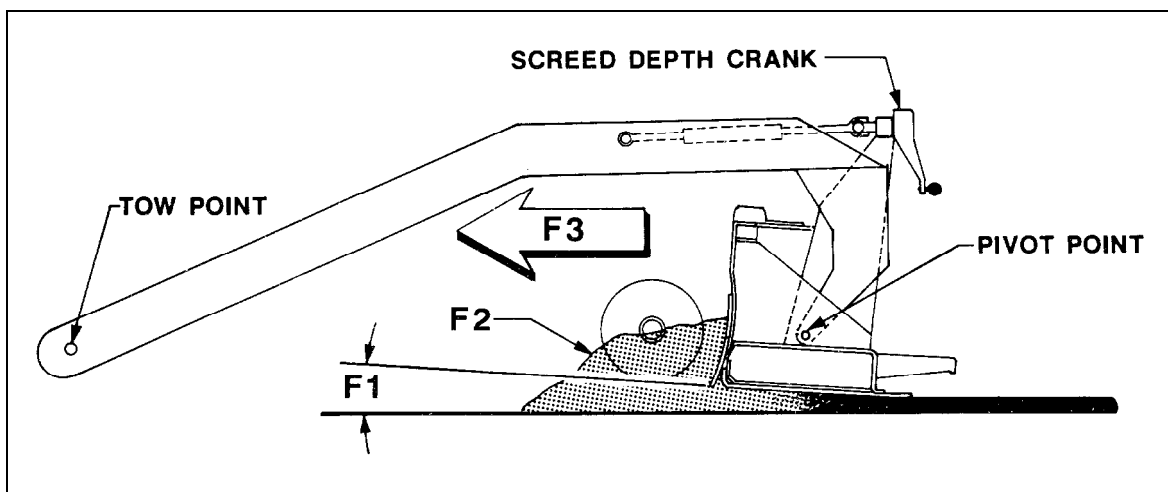

- Factor F-1 – angle of attack,
- Factor F-2 – head of material, and
- Factor F-3 – paving speed.

2-615B Angle of Attack

The angle of attack is the angle that exists between the bottom surface of the screed and grade surface over which the paver is moving. Paving over a flat, level surface with all variables held constant will produce a mat of constant profile. If the screed or tow points are vertically displaced, a change in the angle of attack occurs. The screed moves to restore the original angle as illustrated in Figure 2-6.12. The restoring action of the screed is referred to as “self-leveling.”

When the angle of attack is increased, more material is allowed to pass under the screed, causing it to rise until the screed is again moving in a plane essentially parallel to the cross slope. Conversely, decreasing the angle will reduce the amount of material allowed to pass beneath the screed, causing the screed to drop until it is again parallel to the grade.

The angle of attack is controlled by either the manual screed depth cranks or the automatic level controls. One full turn of the depth crank will raise or lower the screed $\frac{1}{4}$ in. (6 mm). However, adjustments should be made in small increments to produce a smooth-riding pavement. The change in depth begins immediately after adjusting the crank but must move approximately 5 times the length of the screed side arm before the full change in thickness is completed.

Figure 2-6.12 Angle of Attack - Manual or Automatic Control of Tow Points

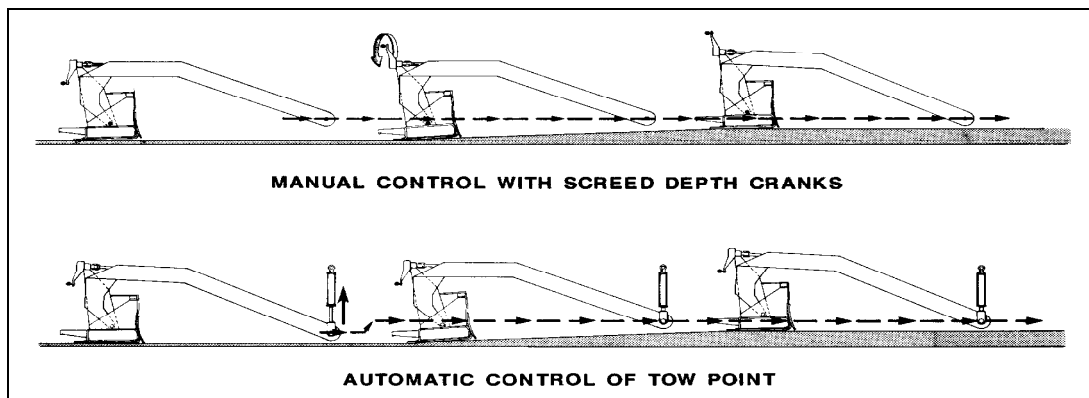

2-615C Head of Material

The head of material is the volume of paving material directly in front of and along the entire length of the screed. The volume and consistency of the head of material are primary factors in the amount of mix that flows under the screed and affects the mat density, texture and profile. The volume in front of the screed determines the amount of pressure or resistance to forward travel exerted on the screed.

The volume of material in front of the screed should be maintained at a near constant level, almost covering the auger shaft along the entire length of the screed. Modern pavers have automatic controls to maintain the correct level. See Figure 2-6.13 for the correct head of material.

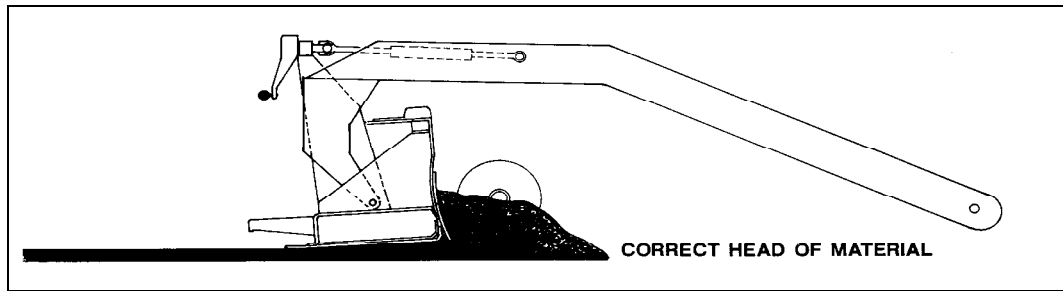
Figure 2-6.13 Correct Head of Material Volume

If the head of material is too high, the resistance to forward travel is increased. The screed will rise, and may cause ripples, auger shadows, long waves, increased depth, and a less dense mat. See Figure 2-6.14. If the head is too low, the resistance to forward travel is decreased and the screed will gradually fall, resulting in a thin mat and possible voids in the mat. See Figure 2-6.15. A fluctuating head of material will result in a combination of the mat deficiencies described above plus alternating changes in the mat texture and depth.

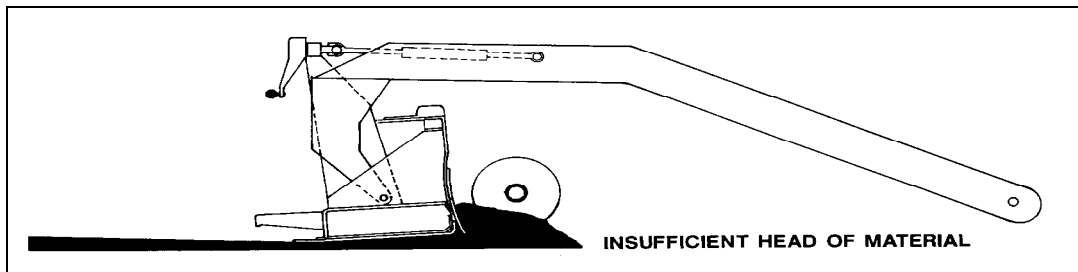
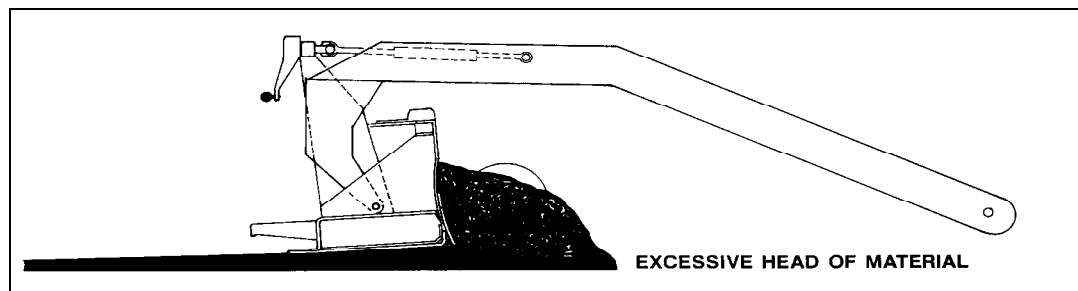
Figure 2-6.14 Head of Material – Volume Too Low**Figure 2-6.15 Head of Material – Volume Too High**

2-615D Paving Speed

The speed of the paving operation should be determined by the rate of material delivery to the paver. The optimum speed results in the paver being in continuous operation, never stopping, using the mixture as it is delivered, and never permitting trucks to stack up waiting to unload. This is referred to as “balancing the operation”. Continuous, uninterrupted forward travel at a constant speed, with other variables held constant, will produce a smooth riding surface. While absolute compliance with this goal is usually not possible, the fewer interruptions or changes in paving speed, the smoother the finished surface will be. The paving speed should be adjusted to that which gives a uniform texture and coordinates with plant production.

Pavers should never be operated at speeds in excess of 40 ft. (12 m) per minute under any conditions. Paver speed in most situations will be slower to match material production and delivery. Failure to balance the operation will result in many unnecessary stops and starts, causing bumps and non-uniform surfaces.

2-615E Other Factors

In addition to the three major factors discussed above, the inspector should be aware of other improper operating procedures that can affect the riding quality of the pavement:

- Truck bumping the paver – this is the most common cause of transverse marks and ridges in the finished mat. Drivers should stop their trucks ahead of the paver and let the paver operator pick up the truck as the paver travels forward.
- Truck driver holding brakes – this will reduce the paving speed causing an increase in mat depth. In extreme instances, it may cause the paver wheels to slip or break traction, resulting in a bump in the mat.
- Unequal or over inflation of paver drive tires can cause the drive wheel to slip or break traction, resulting in a rough, uneven mat.

Excessive hand raking (luting) behind the paver causes segregation of the mixture, and therefore is not permitted. The paver should be so adjusted that only an occasional touch-up should be necessary by hand lutes.

The vibrating screed must be kept hot at all times. The heater unit is attached to the top of the screed plate and is generally used only to keep the temperature of the screed at the temperature of the mix. It is necessary to heat the screed at the start of paving when placing Bituminous Concrete. The heater may be required occasionally during the day, depending on the heat of the mix and the air temperature. If paving is delayed for any length of time during the day, the heater should be lit to maintain the heat on the screed. This will help prevent scuffing or tearing of the surface when the paving operation is resumed. Overheating the screed can cause the screed to warp, which results in poor pavement surface quality.

The screeds must be cleaned at the end of each day of paving and at other intervals as requested by the Engineer. Approved solvents, cleaners and scrapers are used for cleaning. All contact surfaces of paving equipment should be lightly oiled after cleaning. All cleaning should be performed in such a manner that the Bituminous Concrete in place is not damaged by the cleaning agent, and the screeds and equipment must be dry before reuse. The cleaning of the paving equipment must be done in an environmentally acceptable manner. The use of solvents or fuel oil, in any concentration, is strictly prohibited as a release agent or cleaner on any paving equipment.

A mat troubleshooting guide is shown in Table 2-6.1, in the appendix at the end of this chapter. This guide can be used to identify the causes of many problems encountered with the laid mix.

2-616 Hand Spreading

Hand spreading of Bituminous Concrete mixtures is discouraged. Where hand spreading is necessary, the mix should be dumped from trucks onto a platform and spread from this platform. Each shovelful should be turned as placed. Other methods acceptable to the Engineer will be permitted.

Do not allow any walking in the loose mixture, and avoid excessive luting that pulls the coarse aggregate to the surface. Pins and strings should be set to ensure the correct contour of the completed surface. The lutes, shovels and tampers should be kept hot and clean. No cleaning agent that has a deleterious effect on the mixture can be used on the hand tools. The use of solvents or fuel oil, in any concentration, is strictly prohibited as a release agent or cleaner on any hand tools. Also avoid using overheated tools, like when they are cleaned with fire.

2-617 Delays or Shutdowns

Whenever the absence of loaded trucks necessitates a pause, the paver should be stopped with a substantial quantity of mix ahead of the screed and in the hopper. Running the paver until the mix is too low will result in a dip in the pavement, causing the small mass of mix to cool faster.

When a lengthy delay in paving occurs, the screed has a tendency to settle into the fresh mat. Generally, if a delay in excess of twenty minutes should occur, the pavement should be treated the same as at the end of a normal paving day. The material in the machine should be run-out, and the fresh mat completely rolled. When paving is resumed, the end of the mat should be cut back to the point of full pavement thickness as shown on the plans. The paving machine should be reset as is done at the start of each paving day. If this occurs, the contractor Quality Control Plan should be reviewed and the Plan Administrator should make any necessary adjustments to resolve the issue.

When unforeseen weather conditions prevent further placement of the mix, the Engineer is not obligated to accept or place the bituminous concrete mixture that is in transit from the plant. The Engineer may permit placement of material that is in transit when the paving operation is overtaken by sudden storms, provided the mixture is within the temperature limits specified, and a safety hazard does not exist. A large quantity of material can be in transit and will be either placed in less than ideal conditions or wasted. To prevent either from occurring, the Chief Inspector should be familiar with the Contractor's Quality Control Plan and plant production in order to help reach a decision to shut down operations because of inclement weather. This information should be obtained before the start of any paving operations.

The following types of information should be obtained:

- The telephone numbers and names of quality control operators at the plant,
- The Contractor's anticipated production rate,
- The length of time required to stop production,
- The tonnage produced to clear the dryer/mixer after shutdown,
- The number of haul vehicles,
- The anticipated tonnage in transit, and
- The Contractor's estimate of how quickly work can be secured and operations shut down.

The decision to shut down for inclement weather must remain with the paving inspection force. The items listed above must be considered in making that decision.

2-618 Thickness and Tonnage Control

The thickness and width of the pavement structure is shown on the typical sections in the project plans. The actual compacted thickness of each course of material must conform to the planned design. The design thickness is determined so the pavement structure will be strong enough to carry the anticipated traffic. A course can be a lift or multiple lifts comprised of the same Bituminous Concrete mixture placed as part of the pavement structure. A lift is a single Bituminous Concrete mixture placed at a defined thickness.

Figure 2-6.16 Bituminous Concrete Course and Lift Diagram

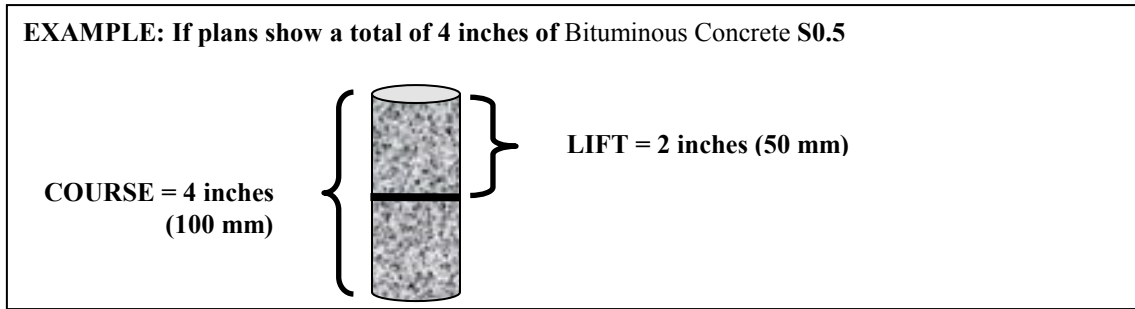

If the mat is too thin, it will likely fail prematurely. If it is too thick, the pay quantities will overrun and increase the cost of the project unnecessarily.

Adequate thickness and width measurements are to be taken and recorded on DWRs. If the depths begin to vary from the tolerances in Special Provision Section 4.06 in the contract, the Inspector should take additional depth measurements until the extent of the problem is identified so corrections can be made.

The thickness of the mat is checked in two ways:

- After initial rolling, make a small hole with a putty knife in the mixture, and check the depth of the course with a depth gauge.
- Check the yield of a load or series of loads actually covered against the theoretical distance that the loads should cover.

Depth variations are permissible in the specifications, and the determination above reflects the paving depth trend. Where the depth measurements indicate an adjustment of measured weight, and it is not practical to determine the limits of the area to be adjusted by normal means, cores may be taken to determine the limits.

The plans specify the thickness that the Bituminous Concrete material is to be placed. This is known as the “planned quantity.” The planned quantity is used in both checks.

If an adjustment for thickness of material placed is required use the Adjustment Schedule for Bituminous Concrete form, see Section 2-636.

2-619 Determining Planned Rate of Spread

Through experience as noted above, it has been found that mixes in Connecticut weigh about 115 lbs. per sq. yd. for each 1 in. of depth (2.46 kg per m² for each mm of depth) when compacted.

The formula for determining the compacted mat thickness is:

$$\frac{\text{Planned Quantity (lbs/ yd}^2\text{)}}{\text{Estimated Weight of Mix [lbs/(yd}^2\text{ _in)]}} = \text{Desired Mat Thickness (in)}$$

Planned Quantity (kg/m²)/Estimated Weight of Mix [kg/ (m² mm)] = Desired Mat thickness (mm)

Example 1: Planned thickness is 3 in. (75 mm).

$$3 \times 115 = 345 \frac{\text{lbs}}{\text{yd}^2}$$

$$75 \times 2.4 = 184 \text{ kg/m}^2$$

2-620 Depth and Yield Checks

2-620A Depth Checks

The thickness of each lift will be checked by taking depth measurements immediately after completion of the breakdown rolling, and while the mixture retains sufficient heat to allow corrective measures to be taken. These depth measurements will be considered as applying for the full width of the lane. The intervals of width and depth measurements in any one lane will vary due to site and placement conditions, but should be taken minimally every 250 ft. (76 m). This information is to be documented in the project records. Refer to the section, "Records."

2-620B Yield Checks

Yield checks are made by comparing the area covered with the quantity placed. It is recommended that a minimum of four (4) yield checks be made per day. Spot checks for individual loads or several loads can be made at any time to ensure that the proper thickness of material is being placed. For most mixes used in Connecticut, the yield should be about 105 to 115 lbs. per square yard per inch of depth (2.24 to 2.46 kg per square meter per millimeter of depth). The mixture should be spread to a loose depth that will produce a specified finished thickness. The loose depth must be determined by experiment.

The actual rate of spread is more accurate than individual depth checks because it considers the average spread over a larger paving area.

2-620C Inspector Responsibility

It is the Paving Inspector's responsibility to ensure that the actual amount of mix placed by the Contractor complies with the plans. The Inspector collects mass slips (delivery tickets) as mix is delivered to the paving site and keeps records of the actual amount of mix placed. This record serves two purposes:

- to document the amount of mix actually placed – *the placed quantity*, and
- to serve as a basis for comparing *the placed quantity* with *the planned quantity*.

The Inspector must compute the actual rate of spread to compare with the planned rate. The planned rate is typically shown on the plans in lbs per square yard (kilograms per square meter), as mentioned above. The actual rate of spread may be computed in lbs/yd² (kg/m²) or lbs. per linear foot (kg per linear meter). Both the planned and actual rates must be in the same units for valid comparisons.

The purpose of computing the actual rate of spread is to determine if the planned amount is being placed. If the actual rate exceeds the planned rate, too much mix is being placed, resulting in an overrun of material. If the actual rate is less than planned, too little mix is being placed and the pavement is thinner than planned. In either case, adjustments should be made to bring the actual quantity in line with that planned.

2-620D Stationing

The distance that a load or series of loads is spread can be determined by noting the station at the beginning and end, and subtracting the lower from the higher. For example:

Beginning 10 + 60.0
Ending 12 + 35.3
Distance 175.3 ft.

Beginning 4 + 250
Ending 6 + 425
Distance 2175 m

2-620E Computing Actual Rates of Spread

As stated above there are two methods of computing the actual rate of spread. The calculations are similar, differing primarily in the units in which the rates are expressed.

Examples of both methods of checking the actual rates with planned rates follow. The sketch in Figure 2-6.17, showing the amount paved and quantities used, applies to both examples.

Figure 2-6.17a Example Paving Layout (English)

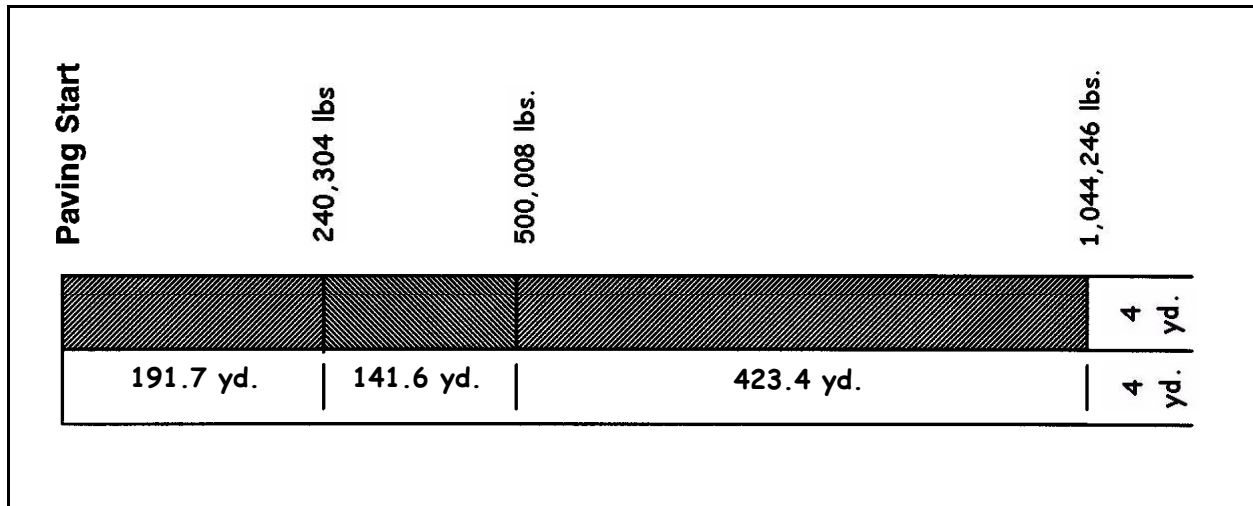
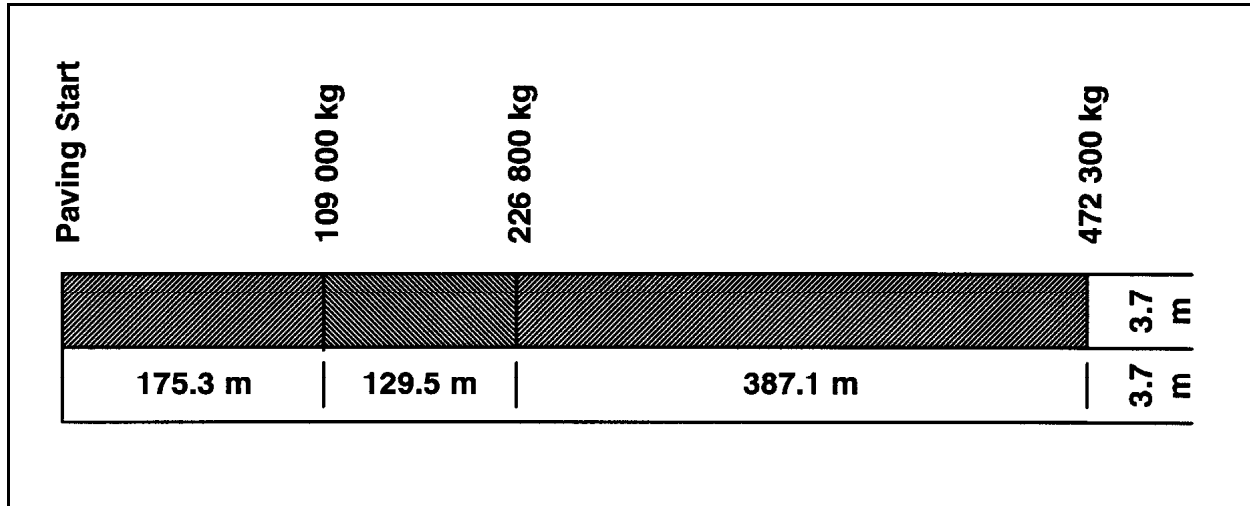

Figure 2-6.17b Example Paving Layout (metric)

**Method 1(English) — Pounds per Square Yard**

The planned rate of spread is 345 lbs/yd²

- A
1. Total the weights of the loads placed, in lbs, to the point where the check is made. The total of the first five loads equals 240,304 lbs.
 2. Determine the total length paved in yards. Loads 1 through 5 covered 191.7 yds.
 3. Determine the area paved in square yards. Total Length × Width Paved = 191.7 yds. × 4 yds. = 766.8 yd²
 4. Calculate the actual rate of spread in lbs/yd².

$$\frac{\text{Total Mix Placed (lbs)}}{\text{Area Paved (yd}^2\text{)}} = \frac{240,304}{766.8} = 313.4 \frac{\text{lbs}}{\text{yd}^2}$$
 5. Determine relationship between the Placed Quantity and the Planned Quantity.
 If Placed Quantity = Planned Quantity: Mat thickness is okay
 If Placed Quantity > Planned Quantity: Overrun
 If Placed Quantity < Planned Quantity: Underrun
 The Placed Quantity of 313.4 lbs/yd² is **less than** the Planned Quantity of 345 lbs/yd².

You are underrunning.

- B
- After Load 10, you have paved 333.3 yds. and have placed a total of 500,008 lbs.
 Area = 333.3 × 4 = 1,333.2 yd²

$$\text{Placed Quantity} = \frac{500,008}{1,333.2} = 375.0 \frac{\text{lbs}}{\text{yd}^2}$$

The Placed Quantity of 375.0 lbs/yd² is **greater than** the Planned Quantity.
 You are overrunning.

Volume 2

C After Load 20, you have paved 756.7 yds. and have placed a total of 1,044,246 lbs.

$$\text{Placed Quantity} = \frac{1,044,246}{3,026.8} = 345.0 \frac{\text{lbs}}{\text{yd}^2}$$

$$\text{Area} = 756.7 \times 4 = 3,026.8 \text{ yd}^2$$

The Placed Quantity **equals** the Planned Quantity.

Method 1 (Metric) — Kilograms per square meter

The planned rate of spread is 184 kg/m²

- A
1. Total the weights of the loads placed, in kg, to the point where the check is made.
The total of the first five loads equals 109,000 kg.
 2. Determine the total length paved in meters.
Loads 1 through 5 covered 175.3 m.
 3. Determine the area paved in square meters.
Total Length × Width Paved = 175.3 m × 3.7 m = 648.6 m²
 4. Calculate the actual rate of spread in kg / m².
Total Mix Placed (kg) / Area Paved (m²) = 109,000 / 648.6 = 168 kg / m²
 5. Determine relationship between the Placed Quantity and the Planned Quantity.
If Placed Quantity = Planned Quantity: Mat thickness is okay
If Placed Quantity > Planned Quantity: Overrun
If Placed Quantity < Planned Quantity: Underrun
The Placed Quantity of 168 kg / m² is **less than** the Planned Quantity of 184 kg / m².

You are **underrunning**.

- B After Load 10, you have paved 304.8 m and have placed a total of 226,800 kg.
Area = 304.8 x 3.7 = 1127.8 m²
Placed Quantity = 226,800 / 1127.8 = 201.1 kg / m²
The Placed Quantity of 201.1 kg / m² is **greater than** the Planned Quantity.

You are **overrunning**.

- C After Load 20, you have paved 692 m and have placed a total of 472,300 kg.
Area = 692 x 3.7 = 2560.4 m²
Placed Quantity = 472,300 / 2560.4 = 184.4 kg/m²
The Placed Quantity **equals** the Planned Quantity.

Method 2 (English) — Pound per Linear foot

The planned rate of spread is 345.0 lbs/yd²

- A
1. Convert the Planned Quantity from lbs/yd² to lbs per linear foot.
The paved area per linear foot is needed for the conversion.
In our example the width being paved is 4 yds:

Volume 2

The conversion is as follows:

$$\frac{\text{Paved Length} \times \text{Paved Width}}{\text{Paved Length}} = \frac{1 \text{ yd} \times 4 \text{ yd}}{1 \text{ yd}} \times \frac{1 \text{ yd}}{3 \text{ ft}} = 1.33 \frac{\text{yd}^2}{\text{ft}}$$

$$\text{Planned Quantity} \times \frac{\text{Paved Area}}{\text{linear foot}} = 345.0 \frac{\text{lbs}}{\text{yd}^2} \times 1.33 \frac{\text{yd}^2}{\text{ft}} = 458.9 \frac{\text{lbs}}{\text{ft}}$$

- Total the weights of the loads placed, in pounds, to the point where the check is made. The total of the first five loads equals 240,304 lbs.

- Determine the total length paved in feet. Loads 1 through 5 covered 575.1 ft.

- Calculate the actual rate of spread in lbs/ft

$$\frac{\text{Total Mix Placed}}{\text{Total Length Paved}} = \frac{240,304 \text{ lbs}}{575.1 \text{ ft}} = 417.8 \frac{\text{lbs}}{\text{ft}}$$

- Determine relationship between the Placed Quantity and the Planned Quantity. The Placed Quantity of 417.8 lbs/ft is **less than** the Planned Quantity.

You are underrunning.

- B After Load 10, you have paved 1,000 ft and have placed a total of 500,008 lbs. Total length = 1000 ft

$$\text{Placed Quantity} = \frac{500,008 \text{ lbs}}{1,000 \text{ ft}} = 500.0 \frac{\text{lbs}}{\text{ft}}$$

- The Placed Quantity of 500.0 lbs/ft is **greater than** the Planned Quantity.

You are overrunning.

- C After Load 20, you have paved 2,270 ft and have placed a total of 1044,246 lbs. Total length = 2270 ft
The Placed Quantity is **slightly more than** the Planned Quantity.

Method 2 (metric) — kilograms per meter

The planned rate of spread is 184 kg/m²

- A 1. Convert the Planned Quantity from kg /m² to kilograms per meter
The paved area per meter is needed for the conversion.
In our example the width being paved is 3.7 m:

The conversion is as follows:

$$\text{Planned Quantity} \times \text{Paved Area/meter} = 184 \text{ kg/m}^2 \times 3.7 \text{ m}^2/\text{m} = 680 \text{ kg/m}$$

Volume 2

2. Total the weight of the loads placed, in kg., to the point where the check is made.
FACTOR: paved Length x Paved Width / Paved Length = 1 m x 3.7 m/1m = 3.7 m²/m
The total of the first five loads equals 109,000 kg.
3. Determine the total length paved in meters.
Loads 1 through 5 covered 175.3 m.
4. Calculate the actual rate of spread in kg/m
Total Mix Placed / Total Length Paved = 109,000 / 175.3 = 621.8 kg/m
5. Determine relationship between the Placed Quantity and the Planned Quantity.
The Placed Quantity of 621.8 kg/m is **less than** the Planned Quantity.

You are underrunning.

- B After Load 10, you have paved 304 m and have placed a total of 226,800 kg.
Total length = 304 m
Placed Quantity = 226,800 kg / 304 m = 746 kg/m

The Placed Quantity of 746 kg/m is **greater than** the Planned Quantity.

You are overrunning.

- C After Load 20, you have paved 692 m and have placed a total of 472,300 kg.
Total length = 692 m
Placed Quantity = 472,300 kg/692 m = 682.5 kg/m

The Placed Quantity is **slightly more than** the Planned Quantity.

2-621 Compaction

2-621A Rolling

Generally, compaction is achieved by establishing rolling procedures referred to as:

- initial or breakdown rolling,
- intermediate rolling, and
- finish or final rolling.

The types of rollers used for compaction of bituminous pavements include:

- Static steel drum
- Vibratory steel drum
- Oscillatory/vibratory hybrid steel drum
- Pneumatic tire

The static and vibratory steel drum rollers are most commonly used in Connecticut. The types, sizes and number of rollers must be approved by the Engineer. The rollers must be of the type appropriate for each phase of rolling. As previously stated in section 2-607, rollers must be equipped with water sprayers and scrapers on the tires and drums. The tires and drums must be kept moist during rolling to avoid picking up the material. Use only enough water to prevent pickup. The equipment must be ready at the job site prior to delivery of Bituminous Concrete and maintained in proper operating condition throughout the paving operation.

2-621B Initial or Breakdown Rolling

Initial or breakdown rolling is normally performed with a vibratory or oscillatory roller having a weight (mass) of not less than 10 tons (9,100 kg). The number of rollers needed depends on the Contractor's rate of production. Where only one roller is needed, a standby roller is required in case of equipment breakdown.

Rolling should begin as soon as the spread mixture will bear the weight of the roller without shoving or cracking. Flushing the pavement with water to hasten cooling is strictly prohibited.

No set rule can be given for the temperature at which the rolling should take place. In practice, rolling operations are governed by trial-and-error experience. With Superpave mixes, initial or breakdown rolling should begin immediately after placement. Rolling performed after the pavement has partially cooled can cause the pavement to have a rough, uneven surface texture or make achieving specified density difficult.

Rolling should begin at the sides or low point and progress toward the center, parallel to the centerline of roadway, as shown in Figure 2-6.18. If a longitudinal joint is formed, it should be rolled first. Alternate trips of the roller should be terminated in stops at least three feet (one meter) distant from any preceding stop. All turning movements should be completed on previously compacted material. Other rolling procedures may be directed by the Engineer as conditions may require. Rolling should be discontinued if the surface shows signs of cracking and should be continued later as directed. Rolling should proceed continuously and in such a manner that all roller marks are eliminated. Rollers must be in good condition and must be operated by competent roller operators. The pavement should be rolled so that the entire surface receives substantially equal compaction.

Figure 2-6.18 Rolling Patterns

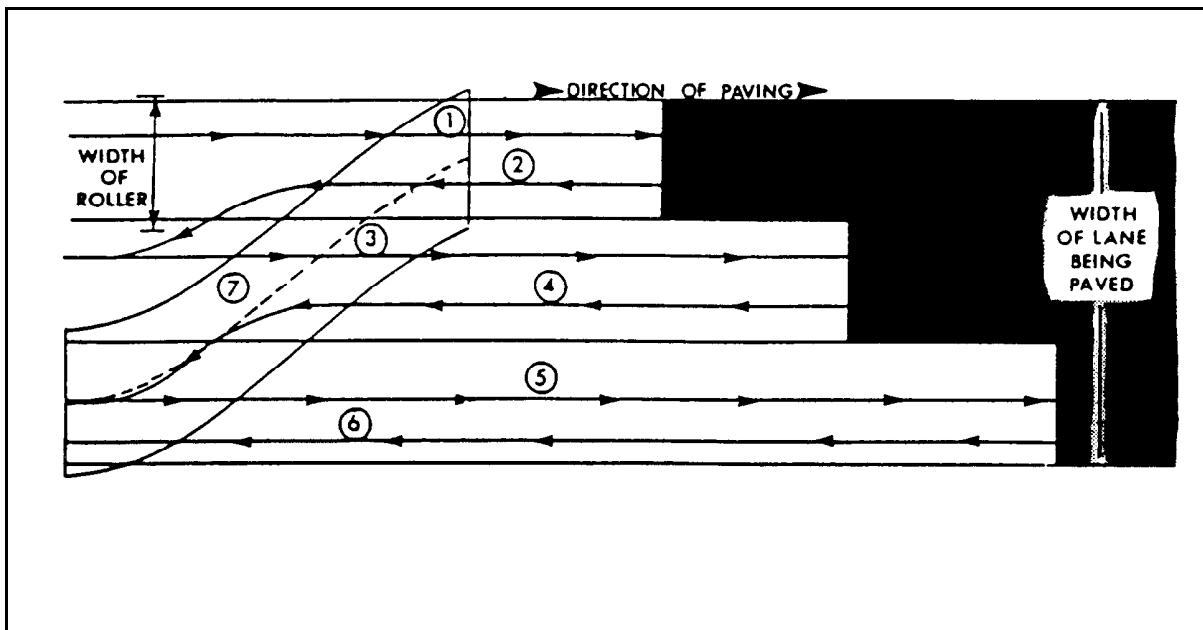

On super elevated curves, rolling should begin at the low side and progress to the high side. All rolling should be done so that each preceding track of the roller is overlapped by at least half the width of the roller. When rolling pavement edges, the roller should extend 2 to 4 in. (50 to 100 mm) beyond the edge of the pavement.

After the required passes are completed, the roller should be moved to the outside of the lane on the cooled portion of the mat to repeat the process on the next segment.

Steel drum rollers should be operated with the drive drum forward, or the uphill direction of paving. The drive drum applies a more direct vertical load than the tiller drum and causes less shoving of the material since the turning force tends to tuck the material under the drum. Exceptions to rolling with the drive drum forward occur when the roadway longitudinal grades are excessive or when the cross slope or super elevation is high. In such cases, the drive drum may chatter, displace the mixture and cause a rough surface. The recommended practice in such cases is to do the breakdown rolling with the tiller drum forward.

Rolling should proceed continuously at a rate that provides for adequate compaction and the removal of all roller marks. Rolling too fast can cause surface cracks and a rough, uneven and wavy surface. The recommended maximum speed for all non-vibratory rollers is 5 mph or 440 fpm (8 km per hour).

2-621C Intermediate Rolling

Intermediate rolling may be done with a static, vibratory, oscillatory or pneumatic-tire roller. Careful inspection during intermediate rolling is necessary as this is where “tender zones” are most likely to exist. Tender zones occur because of temperature differences throughout the thickness of the lift. The surface tends to cool faster than the center of the lift causing fine to moderate transverse cracks in close proximity to each other. If this occurs the intermediate rolling should be temporarily halted to allow the mat to cool 15-25 degrees as measured on the surface.

If a pneumatic-tire roller is used, it should be equipped with wide tread compaction tires capable of exerting an average contact pressure from 60 to 90 psi (420 to 620 kPa) uniformly over the surface, adjusting ballast and tire inflation pressure as required. The ground pressure developed by pneumatic-tire compactors is a function of four factors; tire size, tire ply rating, tire loads and tire inflation pressures.

2-621D Finish Rolling

Finish rolling is normally done by a static roller having a weight (mass) of not less than 10 tons (9,100 kg). Finish rolling should be done while the material is still workable enough for removal of the roller marks. A dual vibrating drum roller, operating in the static mode, may be used as the finish roller.

On certain bridge deck overlays and paving jobs where, due to physical limitations, a full roller contingent is not practical, the Engineer may, at his option, permit a lesser number of rollers provided all compaction requirements are met. The use of a vibratory roller in the dynamic or vibratory mode is prohibited on bridge decks or concrete structures. Oscillatory rollers may be used on most structures when operated at the lowest frequency setting. Inspectors should verify the structure is rated for such compaction systems.

In all places inaccessible to a roller, such as adjacent to curbs, gutters, bridges and manholes, the required compaction may be obtained by plate compactors or hand tamps. Any depressions that develop before the completion of rolling shall be remedied by adding new material to bring the depressions to a true surface.

2-622 Compaction Testing

2-622A Quality Control (QC) Testing

The Contractor is responsible for all quality control testing. In-place density tests are taken to check the compaction of the mat. The Contractor's QC testing procedures are outlined in their approved QC Plan. The Contractor's Quality Control personnel may use cores to correlate the density gauge as outlined in Special Provision Section 4.06 in the contract.

2-622B Quality Assurance (QA) Testing

For contracts with Special Provision Section 4.06 dated 011309 or earlier, Acceptance density testing utilizes the nuclear density gauge.

For contracts with Special Provision Section 4.06 dated 010111 or later, Acceptance density testing utilizes core samples.

In-place densities must be taken for each lift of Bituminous Concrete placed at a compacted thickness of 1 ½ or greater. The required compaction of each lift, expressed as a percent of the theoretical density, is shown in Special Provision Section 4.06 in the contract. Theoretical densities are determined by AASHTO Test Method T209.

2-623 Transverse Joints

All transverse joints shall be formed by saw-cutting. This is performed by cutting existing Bituminous Concrete pavement or bituminous concrete driveways a sufficient distance back from the previous run to expose the full thickness of the lift. A brush of tack coat shall be used on any cold joint immediately prior to additional Bituminous Concrete mixture being placed.

2-624 Permanent Transitions

Permanent transitions are required at the beginning and ending of all paving projects. In addition, a keyway must be milled into the existing pavement for the final course to provide a tight, smooth joint. The depth of the keyway should equal the thickness of the course. A typical keyway is shown in Figure 2-6.20. All permanent transitions, leading and trailing ends, shall meet the length requirements in Special Provision Section 4.06 in the contract.

Figure 2-6.20 Permanent Transition Keyway

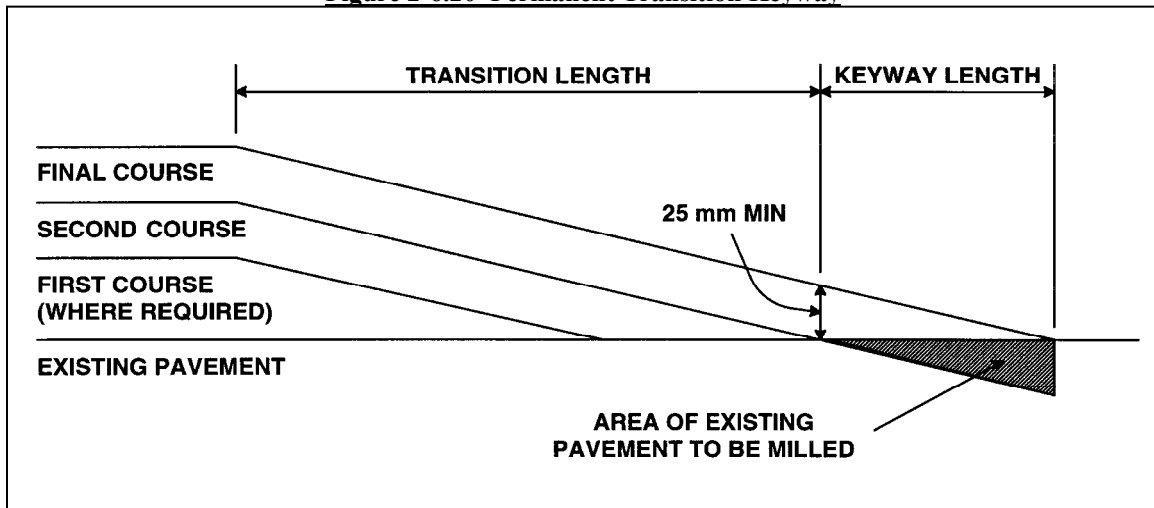

2-625 Permanent Transitions at Structures

Overlays must be transitioned on either side of structures. The lower lift(s) are uniformly tapered for a minimum of 150 feet (46m) on each approach to the structure. The top course is carried over the deck at the same time the course is placed on the roadway.

2-626 Temporary Transitions

When traffic must be carried over the pavement, it is necessary to form a temporary transverse joint at shutdowns and at the end of a day's work. The joint is constructed as shown in the series of drawings in Figure 2-6.21. A temporary transition is defined as a transition that does not remain a permanent part of the work. All temporary transitions shall meet the length requirements in Special Provision Section 4.06 in the contract.

To reduce cold joints to a minimum, the day's run of all passes shall end at the same station.

When paving is resumed, the wedge and paper are removed to provide an exposed mat that is full-depth and at the proper grade for continuing the lay. The screed is blocked up with starting blocks as shown in Figure 2-6.22. The paver should be positioned with the front of the preheated screed over the joint line. After the hot mixture is conveyed into place, sufficient time to reheat the joint should be allowed before moving the paver forward. The paver should be advanced enough to allow the workmen to perform the necessary hand work. Use the straightedge to check the joint to ensure the proper grade before permitting the roller on the surface.

Figure 2-6.21 Construction of a Day Joint

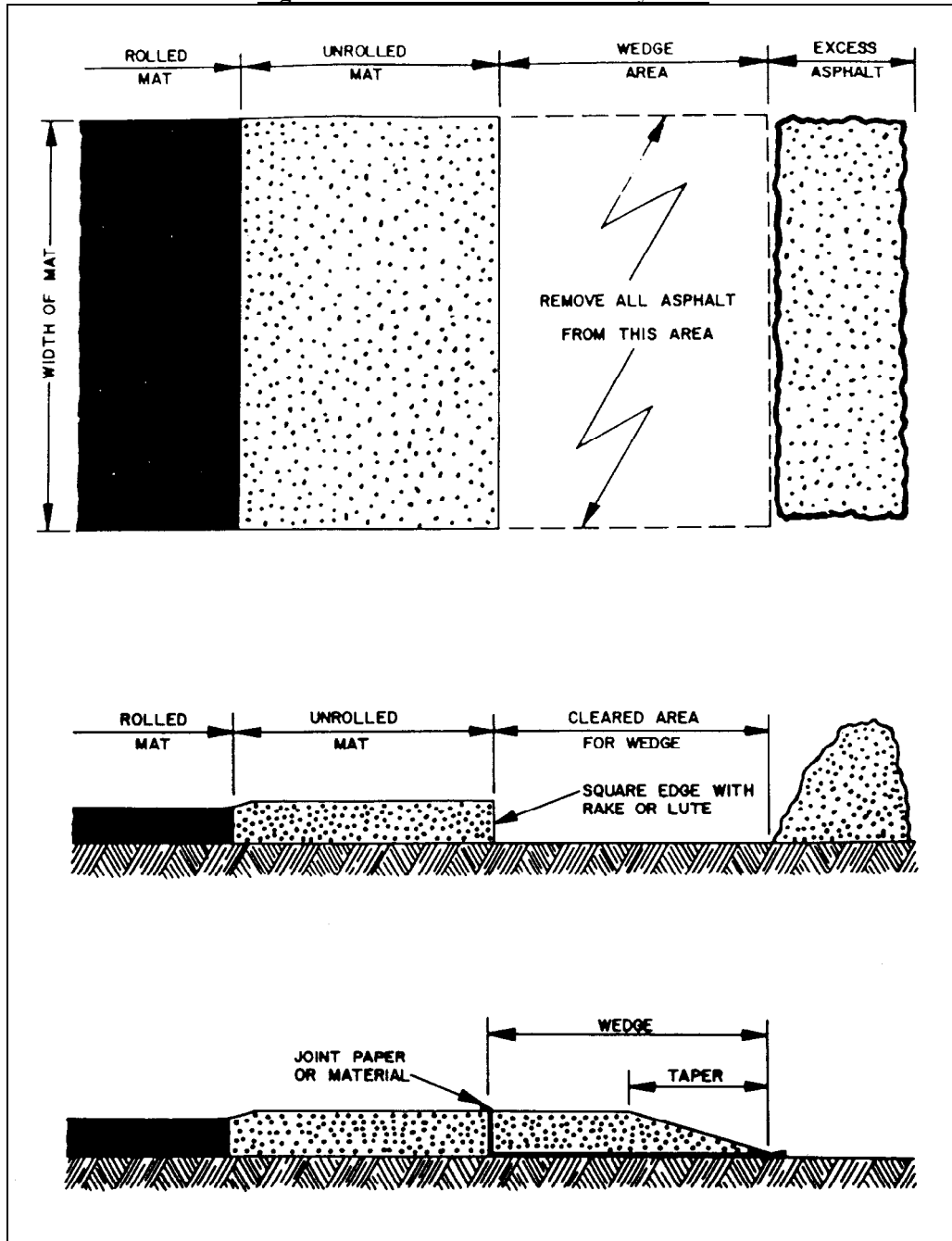
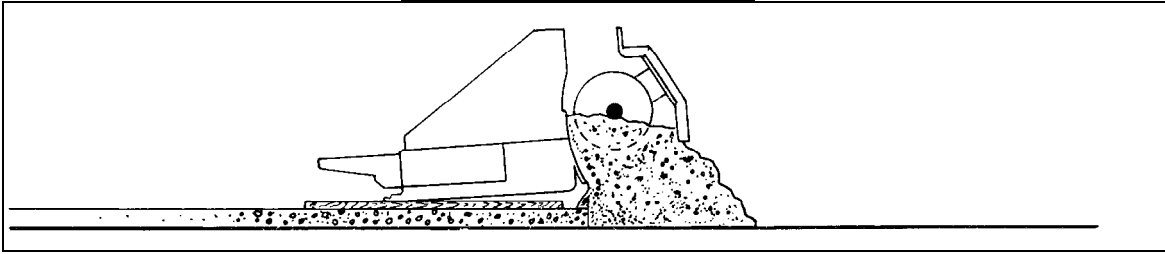

Figure 2-6.22 Starting Blocks



All cold joints are to be coated with liquid asphalt (tack coat) and fresh mixture rolled firmly against the joint face.

The following rolling procedures are suggested for the two transverse joint situations normally encountered.

- *Without an Abutting Lane:* a single lane being paved or the start of a paving operation beginning at the transverse face of an existing pavement. Abutting lanes not yet paved.

The screed unit and hopper box of the paving machine are placed on the existing pavement. Spreading by machine commences slightly before the end of the existing pavement. Hand grading the starting edge is always required. Hand grading segregates the material, and all large aggregate should be pulled off the mat. Adding or removing materials, grading, smoothing and shaping the surface and edges must be diligently done. The surface of the spread material should be slightly higher than the proposed or existing pavement grades. As a general rule, a $\frac{1}{4}$ inch per inch (6mm per 25mm) of compacted thickness should be added to allow for compaction of the lift. Adjust as necessary to achieve proper thickness after compaction. Check the joint with a straightedge before and after rolling.

Ideally, a transverse joint should be compacted transversely. The rolling equipment should operate across the width of the lane instead of longitudinally down the lane. Rolling should commence by pinching the struck edge. The roller is positioned on the existing pavement such that only 6 in. (150 mm) of the roller width will compact the material. Boards, long enough to allow the roller to move completely off the mix on both sides of the pavement, should be placed along the edge of the lane to prevent it from being rolled down. Successive passes should gradually provide for coverage by the full width of the roller drum. If the roller cannot compact the joint in the transverse direction because of site restrictions, the joint will have to be rolled in the longitudinal direction.

When the transverse rolling is completed, longitudinal rolling of the joint can commence, starting at the lower edge of the lane. Following the breakdown rolling, the pavement surface across the joint should be checked with an approved straightedge and string lines. All inadequacies must be corrected and rolled, and the surface rechecked. When the pavement surfaces adjacent to the joint have been satisfactorily graded and compacted, rolling of the lane can commence.

- *With an Abutting Lane.* Lane being paved abuts a paved lane. Setting the paver and starting the spreading operation, including shaping and grading the material is the same as for the first situation described above.

The first pass of the roller should be along the longitudinal joint for about 6 in. (150 mm) of the fresh material. Following the breakdown rolling, the pavement surface across the joint should be checked with an approved straightedge and string lines. All inadequacies must be corrected, rolled, and surface-checked again. When the pavement surfaces adjacent to the joint have been

satisfactorily graded and compacted, rolling of the lane can commence as described in the section, “Paving Adjacent Lanes” below.

2-627 Longitudinal Joints

Longitudinal joints of different lifts or courses should never be constructed directly one upon the other. The longitudinal joint for the first or intermediate lift should be offset 6 to 12 in. (150 to 300 mm) from the exact centerline or lane line. The joint in the top lift should be on the exact centerline or lane line. The joint should never be located under the pavement markings; ideally it should be off-set approximately 6 inches (150mm). The Inspector and the Contractor should decide before paving is begun what the width of each lane should be for both the base and surface courses to provide the overlap between lanes. For each of the lifts placed, an offset line to the edge of the lift should be carefully staked. Paving machines are equipped with a guide bar which is lined up with this offset line, and the machine is held to this line as it proceeds.

To summarize the construction of good longitudinal joints, the following points should be emphasized:

- No joint should be over the joint in the underlying lift or course. Keep them staggered approximately 6 in. (150 mm).
- Keep the joints straight. It is impossible to get a satisfactory joint if the machine zigzags or wanders back and forth across the desired line.
- Maintain near vertical faces on all lane edges.
- Keep the joints clean and free of loose particles of material.
- Overlap the screed onto the previously laid mix enough to ensure that the lane being laid is snug against the other. If this is not done, furrows will develop over time.
- When laying the lift adjacent to a previously compacted lane, allow sufficient thickness for compaction. Normally, the approximate excess thickness should be $\frac{1}{4}$ inch per inch (6mm per 25mm) of compacted thickness. For example, if the designed compacted lift thickness is 2 inches (50mm), the uncompacted lift thickness should be 2 $\frac{1}{2}$ inches (63mm). If too much material is left, a ridge will develop along the line of the joint. Too little material could leave a rut or make achieving specified density impossible.
- Roll the joint as soon as possible.
- Treat the vertical face with a tack coat if it has been left long enough to cool and dry out, or if specified, use heaters.

To obtain tight and well-compacted longitudinal joints, the sequence of Bituminous Concrete placement operations for all courses is subject to the control of the Engineer. When two paving machines are available, practically all of the troubles arising at longitudinal joints can be eliminated by laying hot joints. This can be done by keeping one machine a short distance behind the other so that the adjacent lanes are rolled simultaneously while the material in both lanes is still hot.

2-627A Notched Wedge Joint

When using the Notched Wedge Joint method, the equipment and methods must first be approved by the Engineer. The Notched Wedge Joint must conform to figure 2-6.23. The notched wedge joint device used shall meet the requirements specified in Special Provision Section 4.06 in the contract.

Figure 2-6.23 Notched Wedge Joint

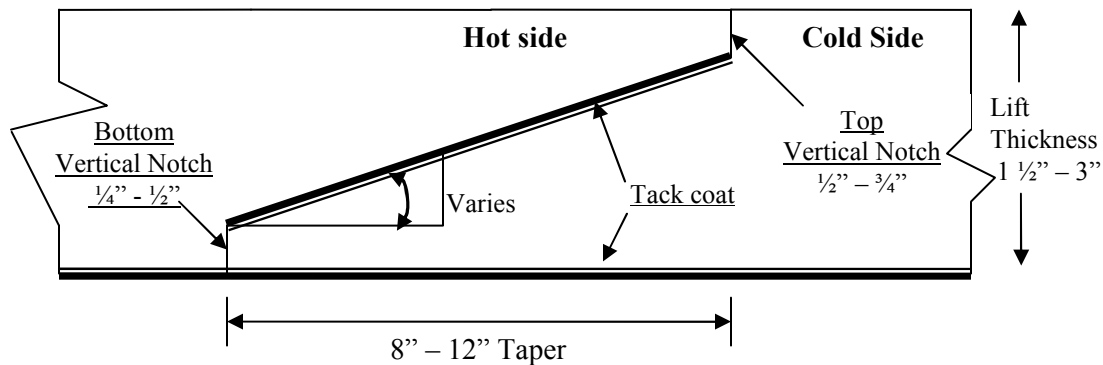

2-628 Longitudinal Joint Construction Methods

The number of longitudinal joints used to pave a roadway full width, or "curb to curb", should be kept to a minimum. For secondary roadways and where ever else possible this would mean the Bituminous Concrete should be spread one-half width in a single pass.

The material being placed in the second lane is then slightly crowded against the face of the previously placed lane. The paver should be positioned so that, in spreading, the material overlaps the edge of the previous lane by no more than 1 in. (25mm) and should have enough excess material thickness to allow for compaction. Generally, the excess material thickness should be a 1/4 in. per inch (6mm per 25mm) of designed compacted mat thickness. No raking or luting of the joint overlap material should occur. Only the occasional 'bumping' back of excess or misplaced material should take place.

2-629 Surface Tolerance

The pavement surface of any lift shall meet the following requirements, or as specified in Special Provision Section 4.06 in the contract, for smoothness and uniformity. Any irregularity of the surface exceeding these requirements shall be corrected by the Contractor.

- Smoothness- Each lift of the surface course shall not vary more than 1/4 inch (6mm) from a Contractor-supplied 10 foot (3m) straightedge. For all other lifts of Bituminous Concrete, the tolerance shall be 3/8 inch (10mm). Such tolerance will apply to all paved areas.
- Uniformity- The paved surface shall not exhibit segregation, rutting, cracking, disintegration, flushing or vary in composition as determined by the Engineer.

Irregularities exceeding the limits above must be corrected. Corrective work usually involves loosening the surface with a rake, adding additional material, grading, rolling and rechecking with a straightedge. Surfaces that look coarse can be improved at this time by the careful addition and grading of select fine material.

Portions of completed pavements that are defective in the surface tolerance, composition or compaction should be removed and replaced or overlaid with additional material, as required.

2-630 Pavement Smoothness (Rideability) Adjustment

A limited number of contracts will contain the item and special provision for Rideability. The smoothness adjustment rewards smooth pavements and penalizes rough pavements. A complete review of the special provision is advised.

2-631 Semi-final and Final Pavement Inspections

Semi-final Pavement Inspections and Final Pavement Evaluations are required on all projects with 2500 tons or more of top course pavement. The Office of Construction's Advisory Team will perform the Semi-final Pavement Inspections and Final Pavement Evaluations with the assistance of the Project Engineer and/or the Chief inspector. The Advisory team will perform these evaluations on any project, regardless of tonnage, that the District deems appropriate. The Districts are required to contact the Advisory Team following the completion of the paving operation so that the evaluations can be performed. The Advisory Team must be invited to the Semi-final Inspection for the initial evaluation. The Final Pavement Evaluation will not be performed until all corrective action, if any, is completed. The contractor must not be issued a relief of responsibility for the pavement portion of the contract or have it accepted until the completion of the Final Pavement Evaluation.

Any Advisory Team recommendation for corrective work should be reviewed by the District and any corrective action that is taken is at the discretion of the District. The Advisory Team must be informed of all corrective work, the type of corrective work and the anticipated schedule for the work as a result of the Advisory Team's recommendations. For those items with recommended corrective action that will not be corrected, the District is required to provide reasoning in writing to the OOC Division Chief for not performing the corrective work.

All required corrections are the Contractor's responsibility, and no payment should be made for the material, labor and equipment used.

See Figure 2-6.25 for sample Final Pavement Evaluation Report

2-631A Opening to Traffic

Traffic is not permitted on the newly laid pavement until the material has cooled and hardened to the satisfaction of the Paving Inspector. Flushing with water to hasten the cooling is prohibited. Vertical pavement edges must be protected to prevent damage before opening the roadway to traffic.

2-632 Records

2-632A Form MAT-100

A MAT-100 must be prepared for each production day to provide testing coverage for Bituminous Concrete material placed. These forms are a permanent part of the field and laboratory records, and therefore must be kept current, accurate and neat. Refer to Volume 1, Chapter 4 – Materials Testing.

The MAT-100 is completed by the Inspector at the end of production for that day. A hard copy is sent to the Department's Material Testing Laboratory. Where there are multiple vendors on a project within a production day, separate MAT-100's must be prepared.

2-632B Weekly Bituminous Concrete Production Report

Each District should forward to the Department’s Material Testing Laboratory a weekly Bituminous Concrete Production Report showing Bituminous Concrete material placed on District administered contracts. Form 2-6.26 is a sample Weekly Bituminous Concrete Production Report.

2-632C Inspectors’ Reports

The Paving Inspector must keep accurate records of the stations worked, locations, areas covered in square yards (m²) and tons (mt) used, and record all batches condemned or wasted with an explanation for the reason for rejection. The information will be included on the Base & Bituminous Concrete Inspection Report (Form CON-136). A sample Base & Bituminous Concrete Inspection Report (Form CON-136) is shown in Form 2-6.27. A Form CON-136 must be completed for every day that paving is performed.

Items to be recorded on Form CON-136 include:

- The project number,
- Weather and temperature readings,
- The item number and Bituminous Concrete mix design ,
- The location of the paving and quantities placed,
- Width and depth checks,
- Any loads rejected and the reasons for rejection,
- The hours worked by the contractor,
- The work force and equipment assigned by the contractor, and
- The inspection personnel assigned.

Thickness checks and yield computations should appear on the Form CON-136, and any significant discrepancy should be explained (i.e. Contractor paved too wide, etc.).

Information for depth checks shown on the Form CON-136 includes:

- The station and offset where the check was made, and
- The depth of each course at that location.

Sample Recording:

Station Offset	Course #1	Course #2	Total
32 + 00.00 7.9 ft. (2.4m) Rt.	1-5/8 in. (41.3 mm)	1-1/2 in. (18.2 mm)	3-1/8 in. (79.4 mm)

2-632D Delivery Tickets

Paving Inspectors are personally responsible for collecting the delivery tickets and signing each ticket as the load is dumped. Project supervisors should check daily to ensure compliance with this directive.

Delivery tickets should be checked for adequate information. The minimum information that should be shown on a delivery ticket is specified in Special Provision Section 4.06 in the contract.

The Inspector should make the following checks:

- Where computerized delivery tickets are provided for the delivery of Bituminous Concrete, verify at least twice a day the accuracy of the individual batch weights that comprise the total. Add the weights of the aggregate and check the total weight on the ticket. Any discrepancies on individual tickets should be reported immediately to the Department’s Material Testing Laboratory.

- Truck delivery tickets should include gross, tare and net weights. Mathematically check the net weight several times each day.
- Note on the delivery ticket when a mathematical check is made and the results of the check.
- If inconsistencies are found on any ticket, all tickets for the day must be mathematically checked.

Temperatures of the mix are to be recorded, with the time taken, on both the delivery tickets and DWRs.

For partially used loads, document how the amount used was determined (measurements), where the remainder went, and the use for the remainder. This information should appear on both the DWR and delivery ticket.

If any Bituminous Concrete is used for an unusual purpose, document the purpose it was used for, reason for use and how the material was paid for. Again, information should appear on both the DWR and delivery ticket.

- Use Form MAT-109 to document core samples. Form MAT-109 accompanies the cores to the DMT.
- Once the DMT receives all the cores for a Density Lot a Pavement Density Adjustment Report detailing the results will be sent to the District.

2-633 Test Frequencies

Refer to the section “Minimum Testing Requirements—Acceptance and Assurance” in the “Schedule of Minimum Requirements for Sampling Materials for Test” for the minimum requirements for acceptance and assurance samples. Sampling and testing for bituminous concrete must be in accordance with those requirements.

If the frequency of assurance tests is found to be insufficient during periodic analyses of projects, it is to be addressed in the preliminary reports and, if not resolved during the project, the final Materials Certificate would list that item as an exception.

2-634 District and Headquarters Monitoring

All projects involving bituminous concrete pavement are monitored by District and Headquarters Record Examiners for compliance with the specifications and policies concerning receipt of and payment for bituminous items.

2-635 Legal Load Limits and Oversize/Overweight Permit Regulations

Inspectors must be aware of the contract requirements concerning load restrictions, legal weight limits for vehicles, and oversize/overweight permit regulations. Refer to the various published documents pertaining to load restrictions that apply to construction vehicles.

If an adjustment is required use the Adjustment Schedule for Bituminous Concrete form, see Section 2-636.

2-636 Bituminous Concrete Adjustment Procedures

There are several different types of adjustments that may have to be made for Bituminous Concrete items that have been placed on a project. Refer to Volume I Chapter 9 for additional instruction concerning adjustment procedures.

Some of the adjustments cannot be made by using original contract items. Review Special Provision Section 4.06 in the contract for the Bituminous Concrete adjustment procedures that apply to your project. All supporting back-up documentation for bituminous concrete adjustments shall be kept in a Volume III book.

2-637 Pavement Rehabilitation

2-637A General

Pavement rehabilitation projects may involve drainage improvements, excavation or borrow material, sedimentation control, traffic control, or upgrading of guardrail and other safety devices. Work involved on rehabilitation projects must be of the same quality as new construction. Refer to the appropriate section in this *Construction Manual* for inspection guidelines for the item being inspected.

2-637B Inspection of Work Site Before Work Commences

The following items should be completed before construction begins:

- The pavement type and the extent of deterioration should be noted and the type of restoration agreed upon between the Chief Inspector and Contractor. Elevations may have to be taken for drainage or rideability purposes. Check for humps, dips and correct cross slope with string line or Locke level shots to determine if leveling courses will be necessary before beginning the main paving.
- Check the elevations and condition of catch basin tops, manhole frames, and water and gas main gates to determine if they can be raised or must be reconstructed. Drainage structures may also have to be extended or rebuilt.
- Check for overhead clearances of utility lines, traffic and illumination lights, bridges, and signing structures. Allow for any roadway elevation increases due to leveling and the overlay in determining if there will be insufficient clearance when the project is completed.
- The profiles of the approaches to bridges must be checked for rideability and proper transitions. Overlaying the bridge may not be done in conjunction with the roadway overlay project. When bridge decks are not paved, milling the approaches is necessary to provide proper rideability. If the bridge and the approaches are on a vertical curve, milling for a greater distance from the bridge may be necessary to provide good rideability.
- Pedestrian and vehicle traffic normally must be carried through rehabilitation project work zones. The Inspector and Contractor should follow the traffic controls in the plans.

2-637C Inspection of Bituminous Concrete Prior to Overlay

The existing pavement should be repaired, where necessary, before a Bituminous Concrete overlay can be placed.

2-637D Repairs to Existing Bituminous Pavement

Defects in bituminous pavements that may require repairs prior to overlaying include:

- Cracks,
- Alligator cracking,
- Potholes,
- Sags, dips, traffic ruts, and
- Bumps.

The methods of repairing these are detailed below.

2-637D.1 Joint/Crack Sealing and Filling

Check the contract for any special provisions on crack sealing or filling. Treat all joints and cracks where detailed on the plans as described in the special provisions.

Any areas that will be milled should be delineated so these areas will not be crack sealed, as this would be a waste of time and money.

2-637D.2 Alligator Cracking Pavement Repairs

Where the pavement has an area in which cracks are too numerous (alligator cracking) to repair, a thin overlay of HMA S0.25 may be necessary. These areas are usually in shoulder areas where the existing pavement thickness is thinner than the travel lanes. Truck climbing lanes are also susceptible to this.

2-637D.3 Pothole Repairs

Repairs to potholes, utility crossings or any depressions should be made at this time. Use a tack coat on all surfaces of the existing pavement to be repaired before placing the repair material.

2-637D.4 Leveling

After crack sealing repairs are made, check the existing pavement for depressions, rises or bumps that may require corrective work. Depressions may require leveling courses and rises or bumps may require milling to achieve a smooth and uniform pavement surface.

The self-leveling capability of paving machines does not eliminate the need for quality grading and preparation of the surface prior to placing the Bituminous Concrete.

Locating areas to be shimmed or milled requires some experience. First, visually check the pavement for areas where shims may be needed. Then utilize hand (Locke) levels, straightedges, rulers, and string lines to determine the type of repair needed – shimming or milling. Checking the existing pavement surface after a rain will make depressions that require corrective leveling easier to spot. The limits of these repair areas should be delineated with paint or keel and be noted on the IR with the depth and Bituminous Concrete mix to be used in the repair.

Depending on the depth of the shim courses, different Bituminous Concrete mixes may be utilized. Base, intermediate or surface material may be used for leveling. Agreements on the HMA mix to be used should be made beforehand between the Paving Inspector and the Contractor. A tack coat must be used prior to leveling.

When the surface of an existing pavement or old base is irregular, it must be brought to a uniform grade and cross section. A leveling course is used when the road surface is so irregular that it cannot be corrected with the normal leveling capabilities of the paver. Leveling wedges of Bituminous Concrete mix are used to level sags and depressions in an old pavement prior to the surface course paving operation. Leveling and wedging are normally used to correct short profile and cross section problems. They may also be used to change the profile of a roadway or cover a milled surface.

Leveling and wedging material must be placed in lifts to ensure compaction. The top of each lift should be parallel to the desired profile or cross section as shown in the top drawing in Figure 2-6.29. Determine the number and lengths of lifts by the allowable lift thickness and the depth of the area to be leveled. To prevent the edges of each leveling pass from reflecting through to the finished surface, it is very important to properly lute (or feather) the ends of each pass. Large aggregate should be removed and discarded.

Wedges are also used to reestablish crown on a tangent roadway or superelevation on a curve, as shown in the bottom drawing of Figure 2-6.29. The number of wedge courses necessary to rebuild the crown or superelevation depends on the total depth to be placed and the maximum aggregate size of the mix. As a rule of thumb, the minimum lift to be placed is four times the nominal maximum aggregate size of the mix. The nominal maximum aggregate size of a mix is in the mix designation. For example, Bituminous Concrete S0.5 level 3 has a nominal maximum aggregate size of $\frac{1}{2}$ inch or 0.5 inches.

Figure 2-6.24 Leveling and Wedging Examples

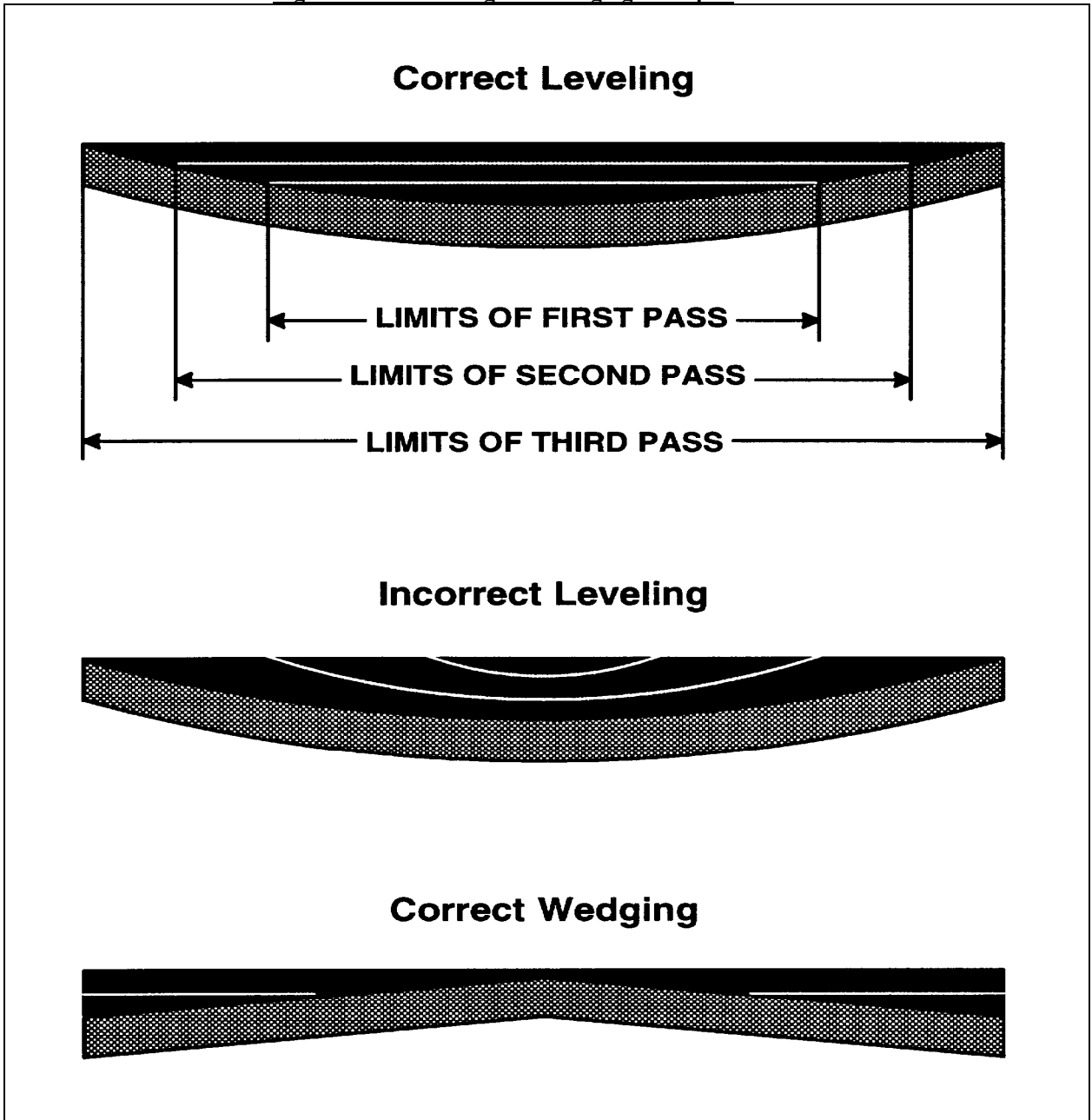

2-637D.5 Milling (Cold Plane Pavement Removal)

Cold plane pavement removal of Bituminous Concrete is the operation of removing a Bituminous Concrete overlay from a roadway surface or a structure to prepare it for a new surface treatment. This surface treatment is most likely a new Bituminous Concrete overlay.

Contractors shall use self-propelled planing machines capable of loosening pavement material, accurately establishing profile grades within a tolerance of a ¼ inch (3mm). These machines shall have a positive means for controlling cross-slope elevations in order to allow placement of the overlay pavement to a uniform thickness. Bridges and other structures may require alternate methods of surface removal, it is recommended to remove Bituminous Concrete overlays from bridge decks by using fine milling equipment capable of uniformly removing the existing surface to depths required. This should be performed after a pre-survey of the overlay thickness has been determined. A pre-survey will limit damage to the bridge deck surface should a cold plane milling machine be used for overlay removal.

Always check contract plans and specifications to review any weight limits for the structures in question. When in doubt, contact the designer of record for clarification. The designer may want to review the catalog cut sheet for the equipment in question.

In response to the availability of different milling items the below delineate specialized milling practices with the intention of designating appropriate milling surfaces prior to resurfacing. It is recommended inspectors review plans against field conditions to assure the proper milling types are utilized.

MILLING OF BITUMINOUS CONCRETE – (0- 4 INCHES)

MILLING OF BITUMINOUS CONCRETE – (GREATER THAN 4 TO 8 INCHES)

MILLING OF BITUMINOUS CONCRETE – (GREATER THAN 8 INCHES)

The standard milling items, listed above, should be used for any of the following conditions and where an overlay of two or more lifts of bituminous concrete is proposed.

- Removal of bituminous concrete in excess of three (3”) inch depth
- Adjust cross slopes to improved storm event runoff
- To completely remove HMA over Portland Concrete Pavement

FINE MILLING (0 TO 4 INCHES) (0 TO 100 MM)

Fine milling should be used for any of the following conditions.

- Generally to remove bituminous concrete from zero (0”) inch to three (3”) inches
 - May be used to remove up to four (4”) inches in limited areas or where required
- To smooth heaved or rutted bituminous concrete (wash boarding)
- To plane off texture or seal coats
- The restoration of rideability to a roadway
- Adjust cross slopes to improved storm event runoff
- Where a single lift overlay of bituminous concrete is proposed

MICRO-MILLING (0 TO 2 INCHES) (0 TO 50 MM)

Micro-milling should be used for any of the following conditions:

- Generally to remove bituminous concrete from zero (0”) inch to one (1”) inch
 - May be used to remove up to two (2”) inches in limited areas or where required
- To smooth heaved or rutted bituminous concrete (wash boarding)
- To plane off texture or seal coats

- The restoration of rideability to a roadway
- Improvement of roadway friction coefficient
- Where an overlay is not anticipated

Any milled area that will not be exposed to live traffic for a minimum of 48 hours prior to paving shall require a vacuum sweeper truck in addition to, or in lieu of, mechanical sweeping. Check the Milling Special provision in the contract for any special milling requirements.

2-637E Repairs to Existing Concrete Pavements

Repairs to concrete pavements may be partial-depth patches or full-depth pavement replacement.

2-637E.1 Partial-Depth Patch Repairs

Partial-depth patch repairs are made with either concrete or Bituminous Concrete. Only spalled areas in concrete pavements will be repaired. The area to be patched will be squared up by saw cutting to a depth of 1 in. (25 mm). The cuts will be made parallel and perpendicular to the direction of travel. The area within the saw cuts is then removed to solid concrete. For Bituminous Concrete repairs, tack coat material must be brushed or sprayed into the patch area. Bituminous Concrete material is then compacted into the repair area. Delaminated areas are not repaired prior to overlays, so chain dragging, sounding, or any other means of detecting delaminated areas is not used.

Again, only visually spalled areas are to be repaired.

2-637E.1a Preparations

Before any existing concrete is removed, the Engineer will perform a visual inspection of the concrete pavement and designate areas where concrete removal is required. The Engineer will identify only the areas where surface distress is evident. Where several areas to be repaired are very close together, the Engineer may combine these individual patches into one large patch area. The minimum size area requiring preparatory work will be as specified in the contract documents. Smaller spalls are cleaned and filled with HMA S0.25.

The limits of each area to be repaired will be defined by the Engineer and suitably marked. All loose and severely deteriorated concrete must be removed within the limits designated by the Engineer. All materials will be satisfactorily disposed of by the Contractor.

The removal of deteriorated concrete will be accomplished by individual blunt-nosed pneumatic hammers, approved by the Engineer. Chisel-point pneumatic hammers are not permitted. The angle from the horizontal of the pneumatic hammers should not exceed 45 degrees. A chipping hammer may only be used for removing deteriorated concrete or existing poor-quality Bituminous Concrete patches. Pneumatic tools should not be placed in direct contact with reinforcing steel. Fillets at inside corners of intersecting limit lines must be carefully removed.

All deteriorated, loose or otherwise poor-quality concrete and Bituminous Concrete patch material must be removed. All exposed surfaces in the repair areas should be thoroughly cleaned of loose and foreign material by air blasting, water blasting, sandblasting, or other acceptable methods. All blasting operations should be performed using techniques approved by the Engineer. Blowing debris into the travel portion of the roadway is not permitted. The resulting surfaces should be free of loose particles, dust, oil, excess moisture, or any other substances. The Engineer will then visually inspect the hole to ensure that all of the loose or poor-quality materials have been removed. Any existing Bituminous Concrete patches that are in good condition should remain in place. Existing reinforcing steel that is damaged and/or corroded, or has insufficient cover, will be removed as directed by the Engineer. This steel will not be replaced.

Sound reinforcing steel, which is in the proper position in the slab, should be left in place. It must be cleaned of any dirt, oil, paint, grease and loose or thick rust before the area is patched.

2-637E.1b Tacking

A light overlapping spray of tack coat should be applied to the prepared area prior to placement of the Bituminous Concrete material. The tack coat should be placed in accordance with Article 4.06.03 of the Special Provision Section 4.06 in the contract.

2-637E.1c Repairs

Prepared partial-depth areas should be filled and thoroughly compacted with HMA S0.25. HMA S0.25 should be placed in accordance with Special Provision Section 4.06 in the contract. The surface elevation of the Bituminous Concrete patch should be slightly higher than the surrounding concrete after compaction to allow for additional compaction under traffic.

In areas where joints or cracks require patching, the loose or deteriorated concrete or Bituminous Concrete should be removed as previously described and replaced with HMA S0.25. The remaining portion of the joint or crack should receive the following treatment:

- Thoroughly clean the crack, in conformance to Special Provision Section 4.06 in the contract
- Place paper rope or backer rod in joints as specified in the contract documents.
- Any joint or crack with an opening 1 in. (25 mm) or greater should be filled and compacted with HMA S0.25 in accordance with Special Provision Section M.04 in the contract.
- Any joint or crack with an opening less than 1 in. (25 mm) should be filled with sealant material conforming to Special Provision Section 4.06 in the contract.

2-637E.2 Full-Depth Concrete Pavement Replacement

If, during the removal operation, the Engineer determines that the pavement has severely deteriorated or faulted to a point where full-depth repair is required, the specification entitled “Concrete Pavement Replacement for Roadway (Full Depth)” should be used. The Contractor may submit an alternate concrete removal method for approval by the Engineer. Milling the deteriorated surface in combination with pneumatic hammers is one such alternative. Carbide-tooth routing machines or diamond-blade grinders may be used.

Refer to the discussion and guidelines in Volume 2, Chapter 7 “Concrete Pavements.”

2-637E.2a Subbase and Subgrade Preparation

Preparation and repair of the subbase or subgrade is usually needed prior to full-depth concrete pavement replacement. Refer to Volume 2, Chapter 5 “Base Courses.”

2-637F Bituminous Concrete Overlay

When the surface of the existing pavement has been repaired and approved by the Engineer, the Bituminous Concrete overlay is placed. The Bituminous Concrete overlay is placed in accordance with Special Provision Section 4.06 in the contract. Refer to the section on Bituminous Concrete pavement beginning on Page 2-6.1 for the inspection procedures.

2-638 Bituminous Lip Curbing

2-638A General

The procedure for submittal of the mix formula for bituminous lip curbing by the Contractor or Producer and approval by the Department's Material Testing Laboratory is the same as that for Bituminous Concrete pavement. Prior to the start of any curb work, the Paving Inspector should receive from the Laboratory an approved job mix formula for "Curb and Paved Ditch" construction.

Bituminous lip curbing should be machine-formed to the dimensions and shape indicated in the standard drawings. The Engineer may permit hand-laid curbing where machine work is impractical. Hand-laid curbing must conform to the same details as machine-formed curbing.

Before placing the curb, the pavement surface must be cleaned of all loose and foreign material. An offset string line should be established on the pavement at a distance from the face of curb recommended for the machine to be used. If it is necessary for the outside wheels to operate in the area behind the shoulder, the area is to be graded and compacted to a smooth surface. A light application of tack coat is to be applied to the pavement area under the curb base. Do not apply the tack material too wide or heavy since it may result in poor curb alignment or inadequate adhesion to the base.

Curbing should be installed as soon as possible after the roadway is overlaid to prevent the pavement being washed out during a rainstorm.

The curb should be backed up with borrow soon after the curb is placed. This borrow shoulder should be seeded as soon as possible to prevent erosion.

2-638B Machine Construction

The curbing machine should be inspected before the operation begins. Most lip curb machines consist of a hopper into which the mix is placed, a motorized worm gear or screw, and the curb mold form. The worm gear pushes the mixture out through the form under pressure. It is this pressure which provides the compaction required by the specifications. If the compaction is inadequate, the Inspector should check with the plant to determine that the mix is correct. The temperature of the mix should also be checked. A mix with a low temperature cannot be adequately compacted. If the temperature is too high, the curb may slough off during placing. The temperature specified on the design mix must be within the master range of 265 to 325 °F (129 to 163 °C). It may be possible to obtain additional compaction by placing additional weights on the machine, or holding back on the machine. Worn screws or dirty molds result in open-textured, scored curb surfaces. Bituminous lip curbing is subject to the same weather and temperature restrictions as Bituminous Concrete paving mixes. Each load of material should be checked several times while the material is being discharged.

The placing of the curbing should be as continuous as possible so as to avoid the need for curb joints. In forming joints, the contact surface of previously constructed curbs should be painted with a thin tack coat just prior to placing the fresh curb mix.

The machine should never be left running while waiting for the trucks. The vibrations from the machine can cause the curb already placed to slough and form a dip in the curb.

The alignment must be parallel to the edge of the pavement, and breaks in the alignment are not permitted. Care must be exercised when hand finishing at obstructions, such as catch basins, and also at the end of the curb, to see that the connection is smooth with good alignment and grade.

2-638C Hand Construction

If curbs are to be placed by hand, the curb mix must be placed immediately upon arrival, or it must be placed on platforms outside the area on which it is to be spread and then distributed into place. The mix should be shaped to the required cross section and compacted by iron tampers weighing not less than 12 lbs. (5 kg) and having a bearing area not exceeding 50 sq. in. (32,260 mm²).

2-638D Bituminous Concrete Driveway Aprons

Where the plans provide for bituminous driveway aprons with bituminous lip curbing, the lip curbing turn-ins should be paved first. This way when the driveway is paved, the roll of the driveway will meet the top of the curb as the design standards show.

The lip of the driveway at the gutter line should be as shown in the applicable standard detail.

2-638E Precautions

The surface of the curbing should be tested with a 10 ft. (3 m) straightedge laid parallel with the centerline of the road, and any variation exceeding ¼ in. (6 mm) will be corrected.

After completion of the curbing, traffic will be kept at a safe distance for a period of not less than 24 hours, and until the curbing has set sufficiently to prevent injury to the work.

Chapter 7 - Concrete Pavements

2-701 *New Pavement*

Concrete pavement consists of a mixture of Portland cement, fine and coarse aggregate, and water. Additives may be used to entrain air in the concrete or to retard set. Fly ash may be used to replace part of the Portland cement. The pavement may be reinforced with steel fabric or bars.

There are two basic types of concrete plants. Central mix plants proportion and mix the concrete. Dry batch plants only proportion the ingredients of the concrete; the concrete is mixed in trucks. Either of the two types of plants may furnish concrete for a paving project.

The pavement is supported by the subgrade and subbase. Volume 2, Chapter 5, “Base Courses,” covers these two subjects. Because the quality of the subgrade and subbase are very important in concrete paving, selected parts of subgrade and subbase construction are covered in this chapter, as well.

There are two basic methods of placing and finishing concrete pavements: side-form paving and slip-form paving. Stationary forms are used in side-form paving. The forms are built to the line and grade of the finished pavement, and the paving equipment rides on the forms. Slip-form paving usually uses string lines for line and grade. The paving units are equipped with sensors that run along the string lines. Concrete is contained by short side-forms built into the paving equipment. Both of the two basic methods are included in the chapter.

Before the concrete is placed, the subgrade is prepared, and the subbase is constructed. Forms or string lines are set, depending on the type of paving operation. Steel dowels are put in position at joints. The concrete is mixed at a central plant or in a truck mixer. While the concrete is being placed, joints are formed, and steel reinforcement is placed, if it is required. After the concrete is placed and its surface is finished, it must be cured and protected from damage while it gains strength. Before the highway is opened to traffic, the joints must be sealed.

2-702 *Specifications and Plans*

2-702A *Specifications*

Article 4.01 of *Standard Specifications* contains information about the mixing of concrete for pavements and the methods of construction for placing and finishing concrete pavements, as well as the methods of measurement and bases of payment for the associated contract items. Article M.03 of the *Standard Specifications* contains information about the materials used for concrete mixes, and Article M.06.01 addresses steel reinforcement. The contract special provisions and the *Standard Specifications* are binding on both the State and contractor in the performance of the work.

2-702B *Plans*

Contract plans provide information related to roadway pavements:

- The typical cross sections show the location, depth, width, and class of pavement to be constructed.
- The plan sheets provide a visual representation of the roadway and the width of the roadway at specific stations.
- The cross sections show finished pavement line and grade by station.

2-703 Inspection Team

The Chief Inspector assembles a paving team consisting of Concrete Inspectors, Form Inspectors, Paving Inspectors, and Finishing Inspectors. The team should be organized as far in advance of the actual paving as practicable. The Chief Inspector should make all members of the paving team aware of their specific duties and make certain they are familiar with the contract specifications.

The Chief Inspector is responsible for the performance and quality of the work, the inspection service, and the inspection personnel assigned to the project. Because of the many operations being performed during the paving phase of the work and the time limitations imposed on them, complete cooperation between the members of the paving team and the Chief Inspector is required.

2-704 Mix Request

Annually, the Central Laboratory approves the operation of all concrete batch plants that will furnish concrete to DOT projects. Additionally, all materials to be incorporated in concrete mixes are tested for approval. The Laboratory designs the standard DOT concrete mixes for each concrete plant. If the concrete for the paving project is furnished from an approved plant, the Chief Inspector should obtain a copy of the approved mixes. An example mix design is shown in Figure 2-7.1.

The contractor may deviate from the approved mixes or use an unapproved plant, such as a batch plant at the construction site. All mix changes require Laboratory approval. Unapproved plants require Laboratory approval and mix designs.

The Chief Inspector should check the contract special provisions for special requirements on additives, aggregate size, cement, and air content. For a mix design, the volume of the batch should not exceed the manufacturer's rated capacity of the drum by more than 10 percent.

2-705 Materials Control

Material sampling requirements are in the publication "Schedule of Minimum Requirements for Sampling Material for Test," published by the Division of Materials Testing. The "Schedule" shows who samples a material, the location from which samples are taken, and the frequencies of sampling. A Request for Test form (MAT-100) must accompany all samples, Certified Test Reports, Material Certificates, and items on the Approved Product List that is submitted to the Laboratory. The Request for Test form is discussed in Volume 1, Chapter 4, "Materials Testing," where a form example can be found.

The Chief Inspector sees that samples of all materials to be incorporated in the work, except materials tested at their sources, are forwarded to the Division of Materials Testing as soon as the materials arrive on the job. If a material is to be tested at its source, the Inspector sends a Request for Test form (MAT-100) to the District Laboratory. The Laboratory representative for the District takes the sample.

Materials cannot be used until a favorable test report is received from the Division of Materials Testing or until the Engineer gives written permission. The State does not pay for work in which unapproved materials are used.

Figure 2-7.1 Mix Design

STATE OF CONNECTICUT
DEPARTMENT OF TRANSPORTATION
BUREAU OF ENGINEERING AND HIGHWAY OPERATIONS
OFFICE OF RESEARCH AND MATERIALS
DIVISION OF MATERIALS TESTING

PORTLAND CEMENT CONCRETE MIX DESIGN

Last Revision Date: April, 2003	Producer: Tilcon CT
Class: PAVEMENT	Location: Hartford

Coarse Aggregate	Fine Aggregate
Type: Traprock	Type: Washed Sand
Source: Tilcon CT	Source: Tilcon CT
Location: Newington	Location: Granby
Source:	
Location:	
	Cement
	Type: I/II
	Source: St. Lawrence
	Location: Catskill, NY

BATCH INFORMATION

Cement:	615	lb.	365	kg
Water:	285	lb.	169.1	kg
Coarse Aggregate:				
#4	825	lb.	489	kg
#6	625	lb.	371	kg
#8	525	lb.	311	kg
Fine Aggregate:	1128	lb.	669	kg

Approved Admixtures: Darex II, WRDA w/hycol

- 1) All weights (masses) are in pounds for one cubic yard (kg for one cubic meter) of concrete.
- 2) One gallon of water weighs (has a mass of) 8.33 lbs. (3.78kg).
- 3) Mix design is based on the weight (mass) of dry aggregate (i.e.; the delivered aggregate weight {mass} will be adjusted due to moisture and the amount of water will be decreased).
- 4) "Butter batches" used for the coating of washed truck mixers shall be in accordance with section 6.01.03(b) of the Standard Specifications, and shall be reflected on the batch ticket.
- 5) Original mix design from the producer has been approved and is on file at the Division of Materials Testing, 280 West Street, Rocky Hill, Connecticut 06067

2-706 Batching and Mixing Equipment

There are two basic types of concrete plants:

- Dry-batch plants proportion the ingredients of the concrete but do not mix the concrete. The concrete is mixed in trucks.
- Central-mix plants proportion and mix the concrete.

Most central-mix plants are automated. There are a few that are not automated, but they are used infrequently. Dry-batch plants are not common in Connecticut. They are used on occasion for limited concrete pavement operations. Generally, they serve as backup plants. Truck-mixed or transit-mixed concrete may be used only with the written permission of the Engineer for limited amounts of pavement and for exceptional cases.

The Chief Inspector is responsible for seeing that batching and mixing equipment is inspected and approved as meeting the requirements of the contract specifications. The Inspector performs much of the required inspection, although parts of the inspection must be performed by other agencies or divisions of the Department. For example, batch-plant scales are sealed by the Department of Consumer Protection, Weights and Measures. As mentioned, the Division of Materials Testing approves all batch plants.

2-707 Plant Personnel

The District is responsible for furnishing Batch Inspectors if they are needed. Automated central-mix plants that are approved by the Laboratory do not require Batch Inspectors. Approved non-automated plants and dry-batch plants require oversight from Batch Inspectors during the start of operations, when changes are made in the mix, and when the Chief Inspector considers it necessary.

Batch-plant personnel and Inspectors must become familiar with and must enforce Article 4.01.03 of the *Standard Specifications* and the rules and procedures that have been set up by the Department governing the control of batching operations. Batch-plant personnel cannot waive any rules or requirements set up by the Department for the control of batching operations. They cannot change the mix, except for adjustments to compensate for variations in water content of the materials. The Chief Inspector should be consulted immediately on any question about the performance of the contractor or operations connected with the plant.

2-708 Truck Mixers

Truck mixers must be certified by the National Ready Mix Concrete Association or approved equal. Certification stickers, verifying approval, will be located on the driver's side door of all certified vehicles.

If the use of truck mixers and truck-mixed or transit-mixed concrete is allowed, the provisions of the *Standard Specifications* must be applied fully. The Chief Inspector or the Concrete Inspector must check to ensure that each truck mixer has been inspected and approved by the Division of Materials Testing and become familiar with Article 4.01.03–C of the *Standard Specifications*.

2-709 Preliminary Checks

The Inspector should conduct preliminary checks of labor for finishing the pavement, miscellaneous tools for placing and finishing, and sampling and testing equipment. The checks should be performed well in

advance of the paving operations to allow sufficient time to correct items that do not pass inspection. If cold weather is expected, the Inspector should check that the proper provisions are on hand.

2-710 Finishing Labor

The Inspector should check the staffing for the concreting operation with the contractor to see if sufficient finishers are assigned to satisfactorily complete the pavement as it is placed. For guidance, the Inspector can compare the actual staffing with the material submitted by the contractor regarding placement and finishing.

2-711 Placing and Finishing Tools

The following tools must be on hand, checked, and approved before paving work starts:

- fine-grade template (scratch board),
- form gauge
- transverse expansion and contraction joints,
- joint caps,
- large square for setting bulkheads and transverse joints,
- vibrators for consolidating concrete along the sides of the forms,
- two concrete spades or two immersion-type high-frequency vibrators,
- a hand-operated screed that can be used in case of breakdown of the finishing machine,
- a burlap drag for finishing,
- material for foot bridges,
- $\frac{3}{4}$ in. \times $1\frac{1}{2}$ in. (19 mm \times 38 mm) spring-steel strips to serve as guides for finishing the expansion joints,
- a device for forming joints,
- at least three lutes of an approved type,
- a master straightedge,
- two 10 ft. (3 m) aluminum straightedges,
- edging tools,
- a hose line or watering carts for curing, and
- curing mats.

The Inspector should check the dimensions and trueness of the fine-grade template and form gauge. All lutes and straightedges should be checked with a string or wire before the operation starts and each morning afterward.

2-712 Testing Equipment

The Inspector should ensure that the following equipment is immediately available for use:

- a slump cone and $\frac{5}{8}$ in. (16 mm) bullet-pointed rod, including suitable platform;
- an air meter or scales and a calibrated container for determining the air content of the concrete;
- at least six cylinder molds; and
- a set of dies and brass tags.

The Inspector should check these items frequently during the project to ensure that deficiencies are promptly corrected.

2-713 Cold Weather Provisions

If cold weather procedures are in effect, sufficient protection material must be on hand, together with approved means to heat water, aggregates, and the contents of the mixer drum, before paving work can proceed. If liquid membrane curing compound is used, a water bath apparatus must be provided, if necessary, to bring the material to the consistency required for application.

2-714 Subgrade

The subgrade acts as a support for the pavement structure. It must be properly shaped and compacted, and the elevation should agree with plan profile and cross-section sheets. The primary concern is to develop an embankment surface that provides firm, uniform support for the subbase and pavement.

All loose rock or boulders over 5 in. (125 mm) must be removed or broken off to a depth of not less than 12 in. (300 mm) below subgrade. The depressions made by removing the large rocks or boulders should be filled with suitable material and satisfactorily compacted.

Trouble areas should be corrected prior to placing subbase. All soft, yielding, unstable material should be removed. The work may involve excavation in fill areas, if there is an indication that the material near the surface is retaining moisture, or it may involve additional excavation in cut areas and the use of a greater subbase depth. It may indicate the need for an underdrain installation. If the surface of the embankment is low, be selective in the type of material used to bring it to grade.

The subgrade must be brought to the required elevation and thoroughly compacted with a power roller weighing not less than 10 tons (9,100 kg) or with an equivalent vibratory roller.

2-715 Subbase

Granular subbase material must conform to the requirements of Grade B, from Article M.02.06 of the *Standard Specifications*, and should be placed in layers not exceeding 6 in. (150 mm) after compaction. The subbase should be compacted with the correct type of compaction equipment. If hauling is done over the surface, it is important to have the traffic distributed evenly.

The Inspector should watch for hard spots in the travel way and soft spots along the edges. If water is applied, the equipment should begin working while conditions are optimum. Scarify or remove the top surface, if it develops an impervious skin because of traffic, concentration of fine soil, and/or puddling action of surface water. Tighten up soft areas with coarse material.

If slip-form paving is used, the contractor must, at no cost to the State, stabilize the subbase on which the pavement is placed and the travel path of the paver. The travel path must not vary more than 3/16 in. (5 mm) from the established grade.

In addition to increasing the structural support for the pavement, the subbase should improve the drainage of the pavement and intercept the upward flow of water caused by capillary action. The Inspector should check the plans for the location of subbase depth changes and eliminate any potential water traps by providing outlets.

If subbase is placed in cut sections, the Inspector must be sure that the underdrains provided for extra depth sections are functioning such that no water is trapped below the subbase. If suitable underdrains were not provided, they must be installed before any concrete is placed.

The grade of the subbase should be left slightly on the high side. The subbase should never be left low so that it is necessary to place material along or under the forms to raise them to the desired grade. The subbase should be brought up to just above fine-grade level prior to beginning form work. The slight excess of material is then removed during the fine grading and form setting operations and disposed of outside of the lane area.

The contractor is required to protect the subbase against the action of the elements or any damage resulting from construction activities. The contractor must provide for draining surface water from the subbase at all times. After the forms are placed, the contractor must take care to prevent water from collecting on the subbase and softening the subbase or forming muddy pockets.

2-716 Side Forms

2-716A Reference Line

The Inspector must use an offset longitudinal grade line as a reference line to check the location of the actual form line. Following the semifinal grading of the subbase material, the survey party establishes an offset longitudinal grade line parallel to the roadway base line, centerline, or lane lines.

2-716B Form Condition

When the forms are first spread out, the Chief Inspector assigns the Concrete Inspector to straightedge each individual form to ensure that each form is free of warps and bends. The top surface must not show a deviation from a straight line of more than 1/8in. (3mm) in 10ft (3m). The lateral deviation must not exceed 1/4in. (6 mm) per 10ft. (3m) section of form. The form locks must be checked to ensure that the forms can be properly locked together when set.

If the forms are bent, twisted, or have irregularities of any kind, the Inspector must order them removed from the work until the defects are corrected. If necessary, the Inspector should mark the forms needing repair with paint. Forms must be clean of all dirt, concrete particles, and rust. Approval of the forms on another project is no reason to accept them.

2-716C Bracing Pins

At least three bracing pins are used to anchor a section of form. The size and length of the pins is important. The requirements vary with differing subsoil materials. However, the pins must be of sufficient size and length to hold the forms firmly in the required position. If the forms show movement during the first placing of concrete, or through use of a fine grading machine, the size and length of the pins are one of the chief items of possible correction.

2-716D Wooden Forms

A wooden form usually is made of well-seasoned lumber of adequate thickness and of a width equal to the depth of the pavement to be placed against it. The form must be thoroughly pinned and braced so that deviations in the line or grade of the completed pavement do not exceed the allowance of the specifications.

2-716E Sharp Curves

If a curve is so sharp that the use of standard steel forms will result in a series of chords, wooden forms or acceptable metal forms must be used. Saw cuts are made at frequent intervals, when necessary, in wooden forms to obtain the true curvature. For a sharp curve, the Inspector must not approve the use of standard steel forms and then depend on the finisher to edge a true line at peaks of the curve. It cannot be done satisfactorily.

2-716F Line and Grade

Before placing the forms, the alignment and grade of the lane, as indicated by the concrete stakes, are transferred to steel pins placed on the actual form line. Offset measurements are made, and the pins are placed for line so that the outer face of a pin is on the edge of the lane. Grades are transferred, and the form grade is marked on the pins with a sharp keel or scratch mark. Masons line, free from knots, is attached at grade elevation and stretched from pin to pin. The line should be carefully checked by eye for any minor irregularities or kinks in either alignment or grade. The string line closely represents the top inside edge of the forms. A slight lateral allowance usually must be made for the longitudinal keyway.

At points of intersection, change of pavement widths or other special joints, a special form layout must be planned so that no featheredge is left. For this reason, it generally is necessary to build the beginning of the flare or taper with the nearest adjacent lane. This special construction should be planned to extend 12 in. (300 mm) or more outside the normal lane edge. An example layout is shown in Figure 2-7.2.

When placing forms adjacent to a completed lane, a grade line should be used. Elevation checks should be made using the completed lane as a grade line, applying the pavement crown or superelevation.

2-716G Form Placement

Forms are set only after the subbase is properly prepared, including the area under the forms. The Inspector must ensure that forms rest firmly on a prepared surface throughout their entire length and width.

The form area is excavated by hand to pavement depth below the string, and each section of form is placed in its approximate position. When a few hundred feet (hundred meters) of forms have been placed, final adjustment is made to the positions of the forms.

Before any concrete is placed, the forms must be in proper alignment and grade for at least 500 ft. (150 m) in advance of a single-lane-width paving operation. The Chief Inspector may allow some deviation from this rule. However, the Inspector may never permit concrete to be mixed and placed if less than 350 ft. (100 m) of forms are properly set in advance of the strike-off machine. If less than 350 ft. (100 m) are ready for pavement, the paving operation must be shut down until the form work is carried ahead at least the initial 500 ft. (150 m). The Chief Inspector must report deviations from the rule to the Project Engineer. The number of deviations should be kept to a minimum.

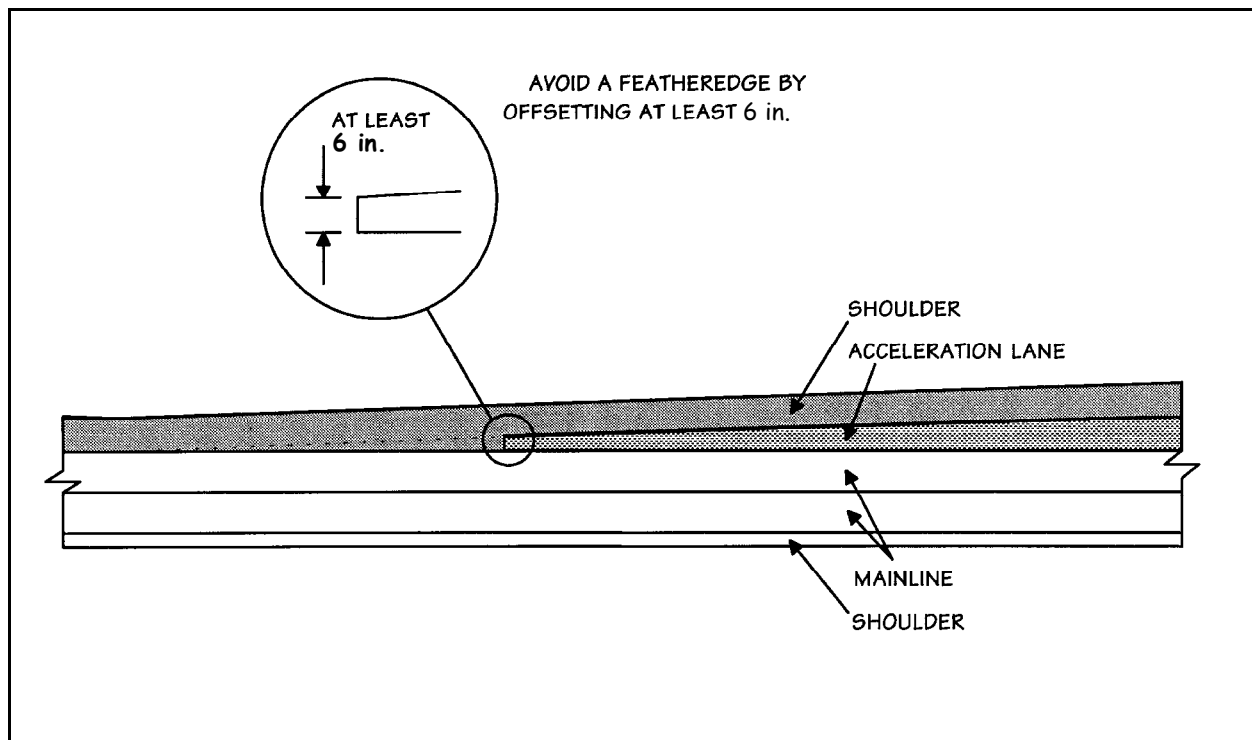
Figure 2-7.2 Layout to Avoid a Featheredge

When approaching or leaving horizontal or vertical curves, the Inspector must ensure that sufficient forms are set ahead to make a satisfactory transition.

The surfaces of all forms that come in contact with the concrete must be thoroughly cleaned and lightly coated with oil. Leaning forms or forms sprung into line are removed and reset.

When paving operations are in progress, the Concrete Inspector must be assured that the forms immediately in advance of the strike-off machine have not been forced out of line by the trucking equipment operating between or adjacent to the forms. If forms are forced out of line, immediate adjustment must be made to bring the forms back and hold them in their original positions.

2-716H Longitudinal Joint Key

The longitudinal construction-joint key is placed in accordance with the standard paving details and must be securely held in position so that it will not move out of alignment if the concrete along the forms is spaded or vibrated. It must extend to within 6 in. (150 mm) of each transverse expansion joint, and particular care must be taken to see that the extremities of the key are supported in the proper alignment.

2-717 String Lines

2-717A Slip-Form String Lines

Slip-form paving operations usually use equipment units that automatically sense line and grade from a string line. One string line usually is used for both fine grading and paving. It is set on one or both sides of the grade, depending on the design of the equipment. Regardless of the terrain over which the machine

must track, it will maintain the grade indicated by the string line. It is important that the string line is as accurate as practicable.

2-717B Normal String-Line Setting

The location of the metal stakes that support the string line is oriented to the grade stakes. Before the hubs are set, the terrain should be visually inspected by the survey party. The following factors must be considered before any hubs are set, to determine the most feasible location for the string line:

- other work that may be performed either between the string lines or along the shoulders,
- the amount of material to be wasted near the string lines and the disposition to be made of the material,
- obstructions along either side of the roadway,
- the limits of the machine sensor-arm supports,
- the height of the string line above grade required for the paving equipment, and
- the percent of fall (cross slope) from the centerline of the roadway to the hubs or edge of pavement.

Location of the string line may vary with each section of the roadway because of superelevations, crowns, and offsets. Each section should be evaluated separately to determine the proper location or position of the line.

Hubs are set after considering the factors above. Setting hubs is one of the more critical phases of the paving operation, as the line and grade for all following work depends on them. The Chief Inspector must ensure that a DOT survey party checks the completed hub run for accuracy of line and grade prior to installing the string line.

Metal stakes are driven into the ground, normally at 50 ft. (15 m) intervals, along one side of the roadway if using a machine equipped with a cross-slope system or along both sides of the roadway if using a machine with sensors installed on both sides. On ramps and superelevations, stakes may be set at 25 ft. (7.5 m) intervals for greater accuracy.

The stake should be located 12 in. (300 mm) to the rear of the hub. It should be vertical and driven deep enough for good stability. The slotted end of the string-line rod must be directly over the center of the tack in the top of the hub and slightly above the intended string-line elevation. The Inspector can use a rule to measure the height of the road above the tack and a plumb bob to assure the rod end is over the tack. Figure 2-7.3 shows a typical setup.

The string line itself is checked, after it is installed and tensioned, so that no sag between stakes is visible. Check the string line with a rule for the exact height above the tack. After the string line is adjusted to the exact height, check for a smooth alignment of the string line by sighting down the line.

Figure 2-7.3 String-Line Stakes

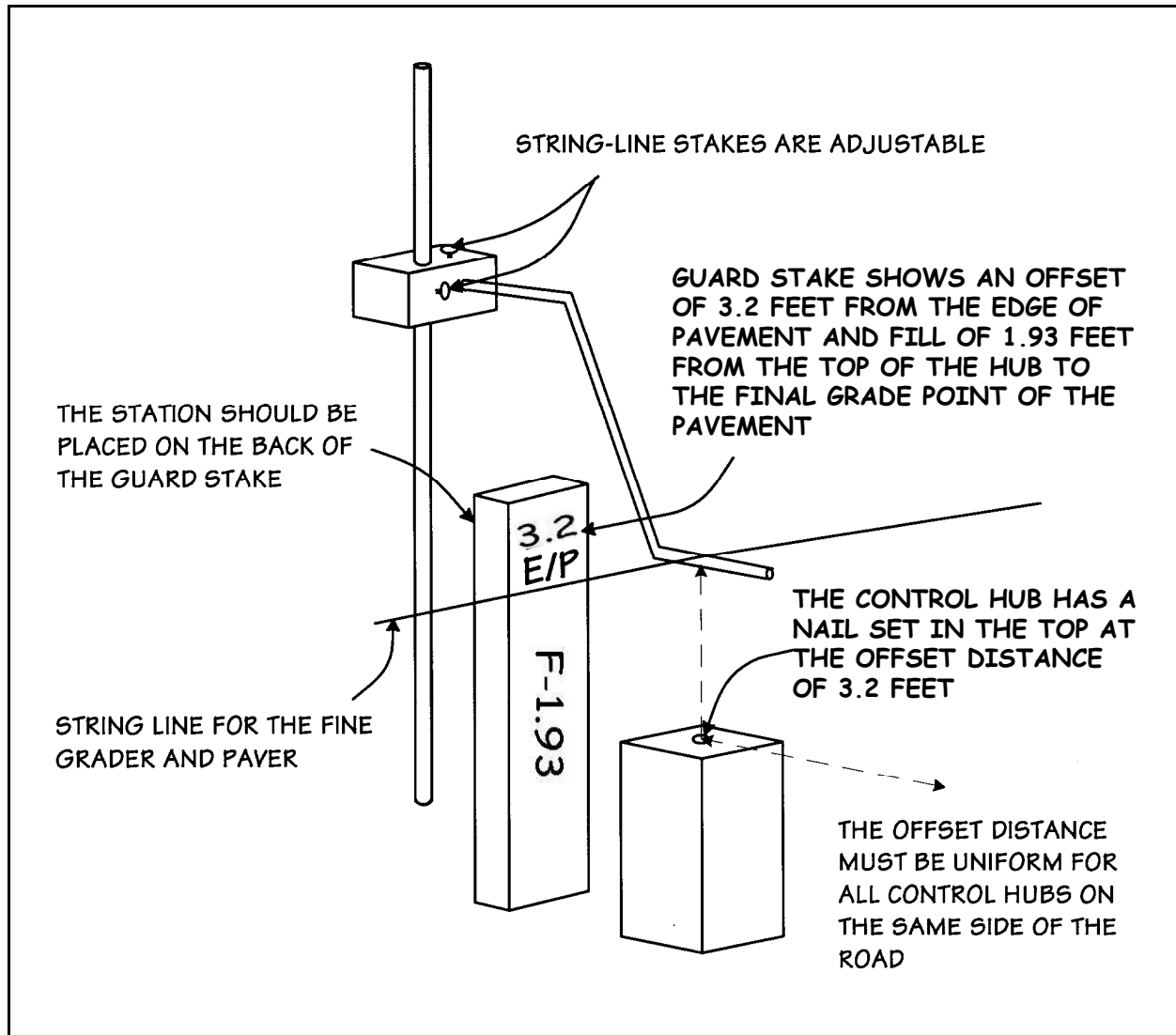

2-717C String-Line Repairs

A break in the string line can be repaired by tying the string line together with a square knot. The knot does not affect the accuracy of the machine but must be tied securely enough to permit re-tensioning of the string line.

If the string line is repaired, moved, damaged, or partially dismantled for any reason, paving operations must be halted until the line can be reset and rechecked. During actual grading or paving operations, a constant watch over the string line must be maintained to prevent interference of any kind from causing a deflection in the line. Examples are personnel leaning against the line, lifting the line to crawl under, and hanging coats or tools on the line, and stakes being nudged by passing equipment.

2-718 Fine Grade

The fine-grade elevation may be determined from accurately set forms or completed lanes of pavement. The Chief Inspector assigns the work to the inspector ahead of the paving operation. It is that inspector's responsibility to see that the subbase is ready to receive the concrete pavement.

The grading is checked with an approved template or scratch board as grading progresses. The bottom contour of the scratch board must conform precisely to the desired contour of the subbase.

The template may be furnished by the contractor and designed to ride the forms; it should be moved along as the fine grading operation progresses. Areas where the points scratch the surface must be cut down and low areas filled in and compacted. There should be at least two templates available for use. When the templates are in use, they must be checked at least twice daily by the Inspector. The Inspector also can check the grade with the use of string lines tied between each form.

If the fine grading is done by a machine, it is adjusted to cut accurately to the required grade. The Inspector must check the fine grade as conscientiously as if the work was done by hand. Some fine grading machines produce a lateral thrust that causes the forms to rock and the form pins to become loose. If this occurs, the operation of the machine must be immediately corrected, or the forms must be more firmly fastened, so that there is no further rocking of the forms.

The current trend favors an adjustable blade unit that is mounted on a grader. The grader works between the forms. The blade unit rolls along the top of the forms, and the surplus material is carried along within the forms and usually removed with a front-end loader. The grade of the blade can be closely controlled, and only a minimum amount of hand labor is required to complete the shaping operation.

Immediately after grading to the required elevation, the fine grade is rolled with an approved roller. The subgrade template is drawn over the completed area for a final check, and irregularities are corrected. The Inspector must be sure that the entire depth of the forms, including bottom edges, is fully exposed.

When concrete is being placed, any irregularities in the subbase surface caused by trucking equipment working between forms must be reshaped and rolled, as needed. If the trucking equipment ruts the subbase, it is an indication that the subbase is not in proper condition for the work.

The Concrete Inspector must continually observe the condition of the fine grade surface immediately ahead of the paving train and keep a close check on its elevation and state of compaction. The check must be by template, as described above. The Inspector should see that the fine grade is thoroughly dampened well in advance of the paving train to prevent drawing excessive amounts of water from the fresh concrete. The procedure of dampening the fine grade must be regulated so that concrete is never placed within 100 ft. (30 m) of the sprinkled fine grade. Concrete must never be placed on a subbase that contains frost.

2-719 Joints

2-719A Transverse

Transverse joint layout is the responsibility of the field forces. Approximate locations of the transverse expansion and contraction joints can be determined well in advance of the paving operation. It is customary to plot the various joints on a set of construction plans. The preferred spacing of the joints is as shown in Figure 2-7.4 and Standard Sheet 401-A.

At bridge structures, ramps or pavement widening it usually is necessary to adjust the length of one or two pavement slabs. The maximum desired length of a slab is 50 ft. (15 m); the minimum length is 20 ft. (6 m).

If it is necessary to adjust a slab length, consideration should be given to the length of the fabric or mat reinforcement. The use of short lengths is discouraged. Adequate provisions must be made for expansion. The maximum expansion-joint spacing should not exceed 1000 ft. (300 m).

If pressure relief joints are called for on the plans, the contractor must construct the joints in accordance with the plan details. A sketch of a pressure relief joint is shown in Figure 2-7.5.

Figure 2-7.4 Transverse Joint Layout

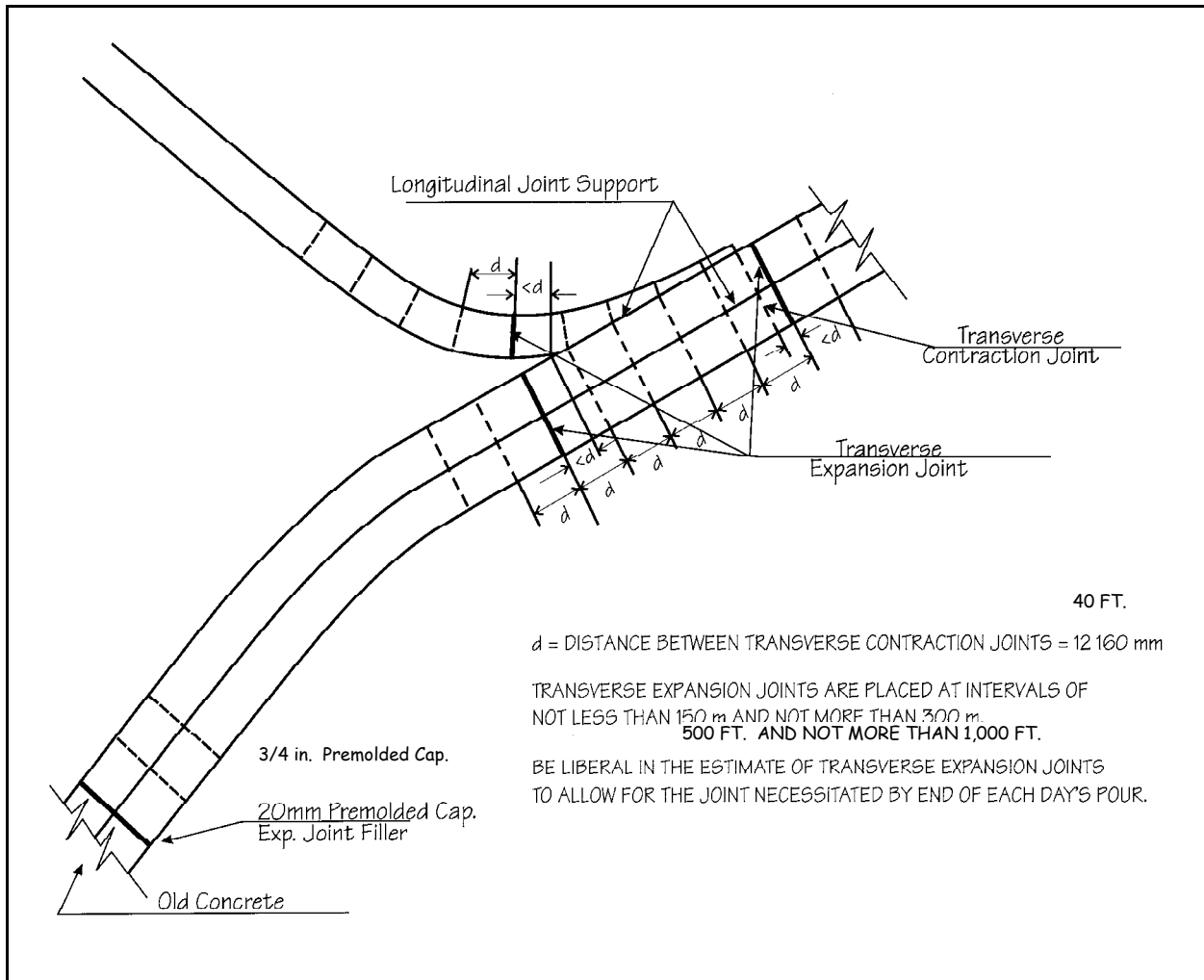

2-719B Longitudinal

The longitudinal joint arrangement must conform to the details shown on the plan sheets or the orders of the Engineer. The current trend in design is to show the specific locations of the longitudinal joints on a plan sheet, providing for lane continuity and delineation that best serve traffic needs. The starting and ending stations of all pavement widening must be complied with unless it is apparent that a minor change satisfies other joint criteria better.

Figure 2-7.5 Pressure Relief Joint

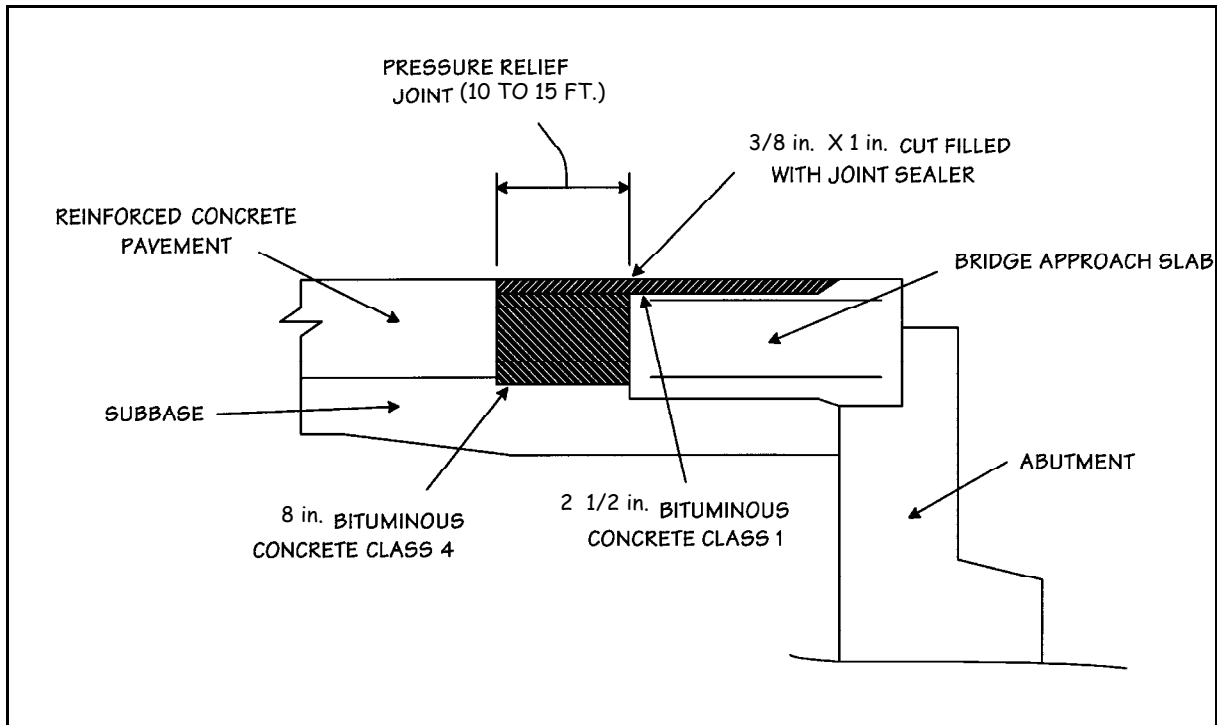

2-719C Locating Transverse Joints

The location of joints for the first lane is made by measurement along the forms with a tape. The transverse line of the joint is obtained by pulling a string across the forms and, with the use of a good square, obtaining a point on the opposite form. Be sure the line is at right angles to the centerline or on a radial line if the joint is in a curve.

After locating the first joint, the Inspector should scribe a line at right angles to the pavement surface on the inside of the forms at the locations of the other joints. If the joint is accurately located for the first lane constructed, the placing and aligning of joints in subsequent lanes is simplified. Any slight deviation in the line of the first joint probably will be amplified in the line of the adjacent joint. On dual-lane projects, care should be taken to see that the line of the joints in each lane is continuous.

There may be changes in length of an original slab because of intersections, drainage structures, inside or outside lanes on horizontal curves, or dual lanes divided by a median area. The Chief Inspector should determine the correct joint location before the concrete pavement is placed. Thus, any adjustment in slab length can be distributed among the slabs to ensure a satisfactory appearance.

2-719D Transverse Joint Construction

The transverse joints normally are expansion, contraction or construction joints. The expansion joint units consist of a horizontally mounted, capped, sliding dowel assembly that is attached to a compressible, yet rigid, piece of joint filler. The height of the joint filler varies with the depth of pavement. However, the top surface is always located $\frac{3}{4}$ in. (19 mm) below finish grade. Figure 2-7.6 is a drawing of an expansion joint.

A contraction-joint unit consists of a horizontal sliding dowel assembly that is installed on the subgrade and extends approximately to mid-depth of the pavement. Figure 2-7.7 is a drawing of a contraction joint. A shallow vertical joint has to be formed in the pavement surface to develop a plane of weakness over the center of the dowel assembly. The vertical joint may be formed in either of two ways:

Figure 2-7.6 Expansion Joint

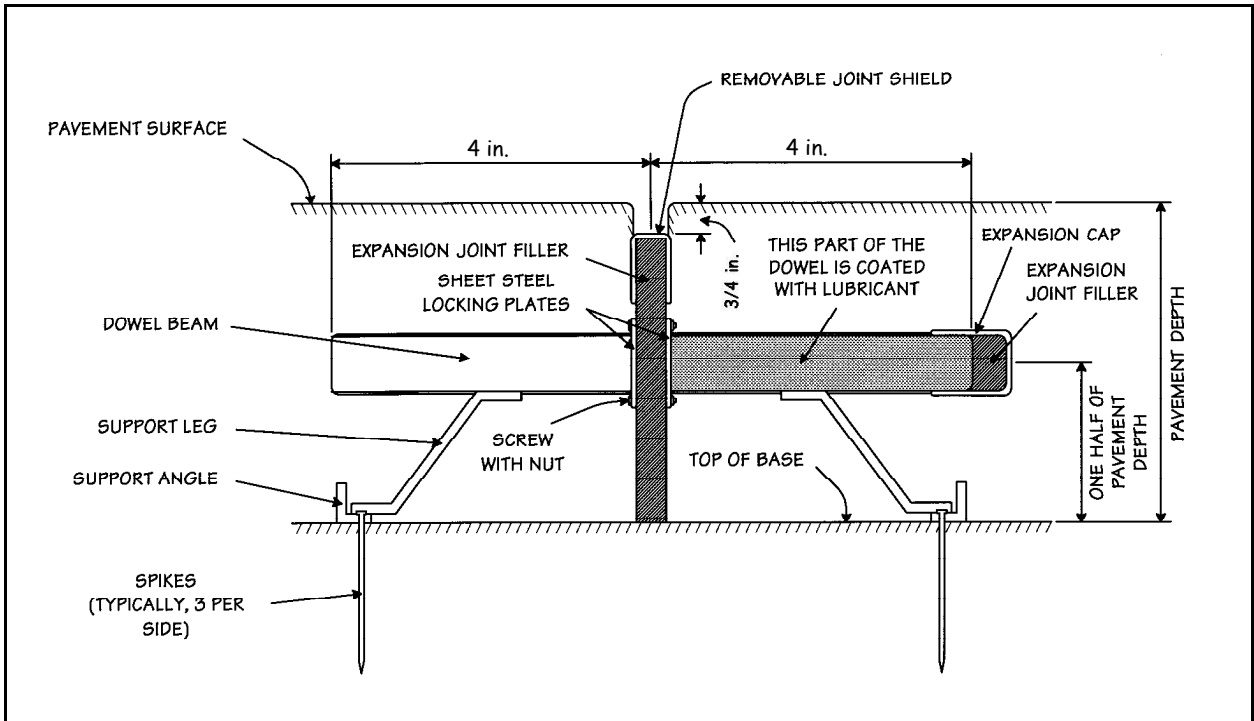
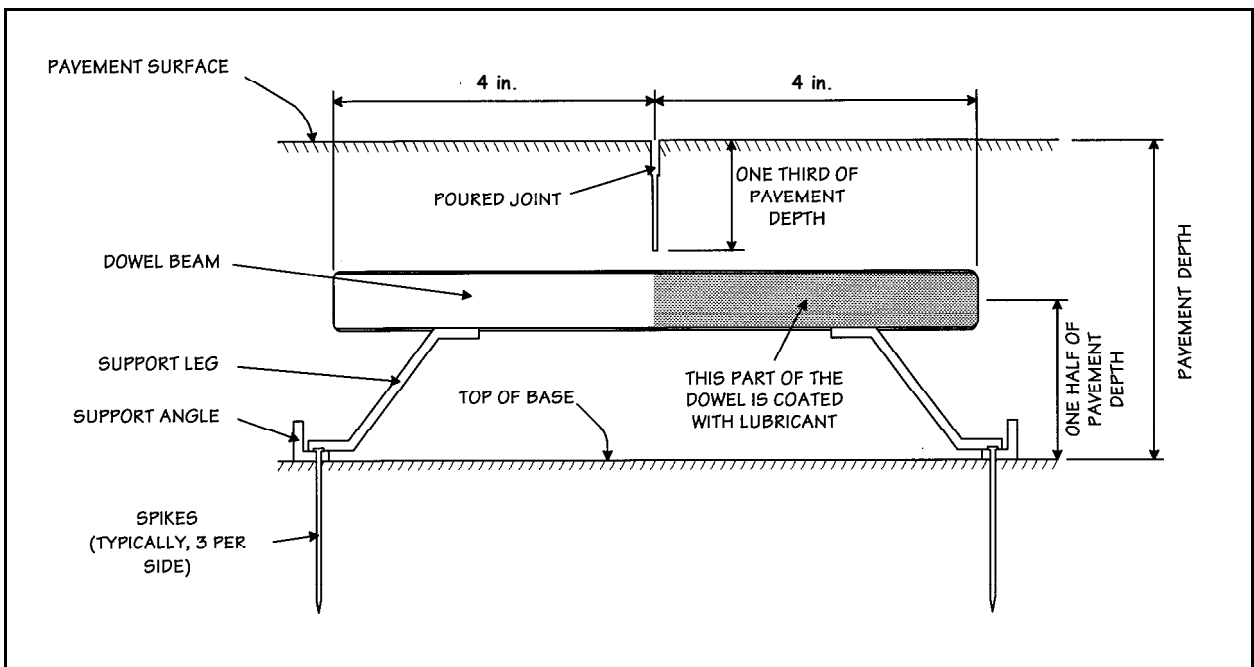

Figure 2-7.7 Contraction Joint



- A steel strip is installed in a holding device prior to placing the concrete. The strip should be removed following the finishing operation.
- A contraction-joint groove is saw cut into the finished concrete to a depth indicated in the specifications or on the plans.

Transverse joints must be installed perpendicular to the pavement surface. If the concrete surfaces adjacent to the joint assembly are inclined, the pavement can slide upward as the slabs expand during long periods of hot weather. Transverse joints must be installed perpendicular to the centerline on tangents or radially on curves.

2-719E Load-Transfer Assemblies

Omission or improper installation of load-transfer units may result in joint faulting, transverse or corner cracking of the ends of slabs, leakage, and pumping. The joint assembly must be installed so that the longitudinal axes of the load-transfer units are not only parallel to the surface of the concrete but also parallel to the longitudinal axis of the pavement. A relatively small deviation from the correct alignment may cause a very high localized stress in the concrete surrounding a load-transfer unit, particularly during extreme temperatures that cause relatively large movements of the concrete at the joints.

Joint assemblies must not be installed until after the final check on the subbase is completed. Place the expansion assembly in the proper location. Make sure that the ends of the joint butt against the forms and coincide with the vertical line drawn on forms. The bottom of the joint, as well as the joint supports, must rest on the subbase for the entire length. Preventing mortar from flowing around the ends or under the joint helps ensure a cleaner joint, less hampered movement under temperature changes, and freedom from localized stresses.

Check all caps on load transfer units with expansion slip dowels for adequate expansion space.

The joint should be anchored in the manner indicated by the *Standard Specifications* or the standards attached to the plans. Recheck the line of the transverse joint with a square, and check the line of one or two load transfer units for right angles with the joint. After placing the metal protection cap on the joint, pull a string across the forms and check the depth of the joint below finished grade. Pull a string slightly ahead of the joint and check the distance down to several of the load transfer units. Repeat the operation in back of the joint. After a joint is set and checked, do not allow the workers to walk on it or to disturb it in other ways.

Tie down the transverse joint units with suitable pins or 60d nails. Be sure that the assemblies are not cocked or tipped and that the dowel component is parallel to the base and surface. Lubricate the caps on the ends of all expansion joint dowels.

2-719F Dummy Joints

Dummy transverse joints, or weakened plane joints, are constructed at the locations and according to the dimensions shown on the plans. The horizontal controls that apply to transverse expansion joints are applied to the locations and line of dummy joints.

After the transverse screeding operation is complete, but prior to longitudinal screeding or luting, a groove is made in the soft concrete by a suitable device. It should extend vertically downward from the surface to the depth shown on the plans and be true to line. Insist on a uniform depth throughout the length of the dummy joint, as well as a consistent depth for each joint. Do not allow the workers to enlarge the groove when edging. The larger the opening, the greater are the chances of obtaining a rough-riding pavement.

2-719G Bulkheads

Bulkheads are constructed if the end of a day's run or shut down for lunch occurs at a transverse expansion joint. Install a 2 in. (50 mm) wooden bulkhead, cut to proper depth and contour, and slotted to slip over the load-transfer units in back of the transverse joint. Securely stake the bulkhead to prevent misalignment of the joint. About 5 ft. (1.5 m) beyond the joint, place a section of regular road form transversely across the road with its top at finished grade, for use as a second rail. Operation of the lute at the end of the slab is to be done from the concrete and the top of this cross form to prevent a short wave in the end of the slab.

2-719H Construction Joints

Transverse construction joints are formed only in case of breakdown causing a delay of more than 30 minutes in the concreting operations. The length of pavement laid up to the time of breakdown cannot be less than 10ft (3m) from the nearest joint. Shorter sections must be removed. Transverse construction joints are constructed in the same manner as transverse expansion joints, except that a bulkhead of wood or steel is used, and no expansion material or load-transfer units are required. Tie bars conforming to the requirements of longitudinal tie bars are placed at intervals of 2½ ft. (0.75m) or less across all transverse construction joints.

2-719I Longitudinal Joint Construction

Longitudinal joints serve to delineate traffic lanes for the motorist. If improperly laid out, the joints can have an adverse effect on the planned flow of traffic. Thus, it is vitally important that the pavement layout and longitudinal joint details do not deviate from the requirements of the construction plans.

For single-lane construction, the longitudinal joint between slabs must be of the tongue-and-groove type, equipped with tie devices. Figure 2-7.8 shows this kind of joint. The keyway form should be checked for size, shape, and proper attachment to the pavement form. It should be continuous on the inside lane form and properly installed on the outside lane form for abutting ramps and pavement widening. The joint keyway form should extend to within 6 in. (150 mm) of each transverse joint. If the joint keyway form is steel, it is necessary to cut the end of the transverse expansion joint filler material to fit. However, before placing the abutting lane, a precut piece of suitable filler material should be placed in the form cutout. The longitudinal joint support units should be properly installed, firmly attached to the form, and properly oriented.

The normal spacing of the tie devices is 5 ft. (1.5m) center to center. Ten foot (three meter) forms generally have holes spaced 2½ ft. (0.75m) on centers. If the Inspector establishes the location of the first transverse joint closest to the point where the forms are being set, the proper location for the tie device can be easily established. Succeeding longitudinal joint assemblies then can be installed at the prescribed spacing. If lane length differences result from horizontal curvature or other reasons and the prescribed joint spacing and clearance cannot be satisfied, additional holes might have to be made in the forms. The holes are usually needed at transverse joint units.

If new lanes are constructed adjacent to existing roadways, special types of longitudinal joint assemblies are specified. Grouted-in-place dowels and expansion shield bolts are frequently used.

For multilane pavement construction, the longitudinal joint support units may be installed prior to the placement of the lower course when the transverse baskets are set, or they may be placed by hand or by a mechanical placer after the lower course has been brought to grade. The joint supports consist of steel tie bars and are 5 ft. (1.5 m) on center.

Longitudinal joints for single-lane construction are usually finished by hand. For multilane construction, the joints may be formed by means of an approved nonmetallic joint forming insert or by saw cutting.

Figure 2-7.8 Longitudinal Joint

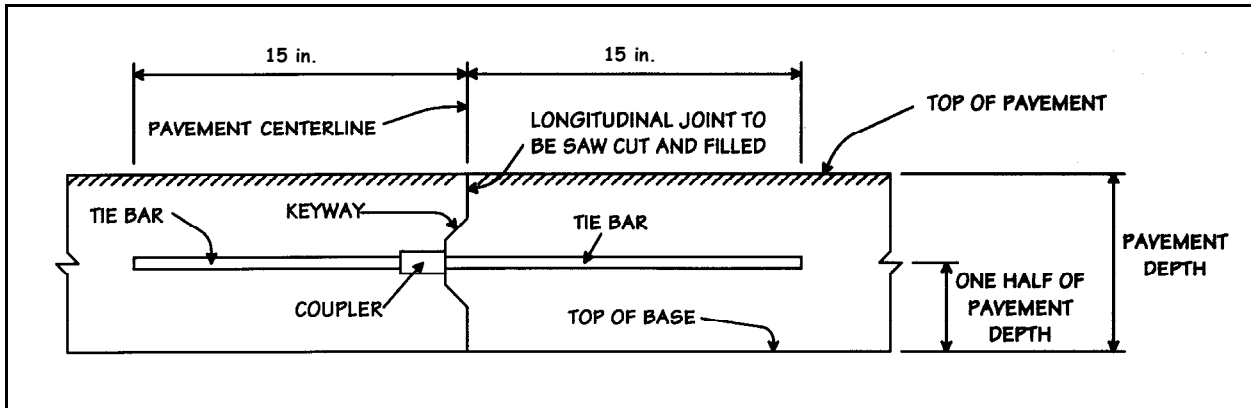

2-720 Paving Trains

Different types of equipment are needed to spread, consolidate and strike off the concrete, place reinforcement if required, and finish the pavement. The equipment units follow each other in a line during paving operations and, taken together, are called a “paving train.” The types of equipment vary considerably. Some machines perform a specific operation; others perform several.

2-720A Side-Form Paving

One type of paving train can be called the “open screed” type. Distribution of the concrete between the forms is achieved initially by spreading out the material as it is being discharged from trucks or hoppers, such that the transverse screeds on the finishing equipment can complete the placement. The train normally is made up of the following sequence of equipment units:

- a lower course strike-off machine,
- a top course strike-off machine,
- a transverse screeding machine,
- a longitudinal finishing machine, and
- a tining machine.

The transverse screeding machine can serve as the top course strike-off machine; however, this usually means it must make two passes over the pavement surface.

Another type of paving train can be called the “hopper” type. The concrete is discharged from trucks or a mixer into hopper units on the finishing machines. The hoppers travel across the lane, discharging the concrete through a hopper gate. Fixed plates and transverse screeds strike off and consolidate the concrete.

This type of train usually has the following:

- a lower course strike-off machine,
- a top course strike-off machine,
- a longitudinal finishing machine, and
- a tining machine.

All of the machines probably would have transverse screeds, except for the tining machine.

Either of these paving trains is acceptable. It is permissible to place the slab full depth at one time and vibrate the reinforcement into position. Substituting a comparable piece of equipment used in one train for that used in another is permissible, providing the paving train is complete and the necessary operations are performed satisfactorily.

The paving train machinery should be placed on graded forms before the following components or operations are checked. The inspection should be performed a few days before pavement operations are scheduled to start, so that adjustments can be made without delaying work.

2-720A.1 Initial Strike-Off Spreader

The Inspector should check for the conditions listed below.

- The strike-off plate is straight and clean.
- The strike-off plate is properly set for the lower course depth.
- The distributing or spreader arm on a Blaw-Knox unit travels the full width of the lane.
- The distributing hopper on an M-xon unit travels the full width of the lane.
- The hopper gates open and close properly.
- The distributing movement is smooth and does not rack the forms.
- The strike-off plate can be readily raised and reset for expansion joints.
- The wheels have scrapers.

2-720A.2 Transverse Finishing Machine

The Inspector should check for the conditions below.

- The screeds are clean and straight.
- The leading edge of the front screed is set 1/8 to 3/16 in. (3 to 5 mm) above the rear edge.
- The rear screed has a front tilt of 0 to 1/8 in. (0 to 3 mm).
- The screed frequency can be changed.

2-720B Slip-Form Paving

A slip-form paving train is made up of self-propelled equipment units designed with side forms. The side forms must support the concrete long enough to avoid appreciable edge slumping and to allow necessary finishing while the concrete still is within the forms. The units usually are:

- a slip-form spreader machine,
- a slip-form paver machine, and
- a finishing machine

2-720B.1 Spreader

The spreader receives the concrete from the hauling units and places it in rough form in its proper location on the roadbed to the depth of the mat reinforcement. Reinforcement mats are placed immediately behind the spreader.

2-720B.2 Paver

The paver normally performs the following functions: depresses the mesh; consolidates the concrete; strikes off, screeds, and floats the surface; forms the slab edge, including keyways; and inserts the longitudinal joint support units. Before starting, the Inspector should check for the following conditions.

- Mesh depressor is set to the correct depth.
- Screeds are set to grade and the pavement template.
- Float pan is clean and properly adjusted.
- There is a sufficient supply of longitudinal joint support unit inserts on board.
- All attachments (depressor, vibrators, etc.) are properly functioning.

2-720C Finishing Machines

Finishing machines are used both in side-form and slip-form paving. They may be of the transverse screed type, longitudinal screed type or longitudinal float type. Check for the following conditions.

- The screeds are straight and clean.
- The screed end pans are not worn excessively.
- The connection and fit of the end pans on the screed are satisfactory.
- The screed is set according to the manufacturer's recommendation.
- The screed distributing arms are operable.
- The float unit is clean and straight.
- The float unit is adjustable and can be raised and lowered easily.
- The float unit is not subject to distortion in its raised position, as when moving.

2-720C.1 Longitudinal Float

The longitudinal float should be checked by using the guidelines below.

- The screed blade must be straight. It can be checked with a taut wire held along each edge and along the center of the blade. Adjustments can be made by bolts provided for the purpose. If the screed blade is dented or bent so that proper adjustment cannot be made by the bolt adjustment, a new blade must be provided.
- The blade must be flat and smooth at the bottom, with relatively sharp corners. Check by placing a straightedge transverse to the screed at several points. If the bottom is worn round inside the original bevel, the blade must be discarded. Failure to provide a blade that is a plane on the bottom may cause longitudinal rippling or tearing.
- The bottom of the screed must be the plane of the top of the concrete. Check for longitudinal compliance with wires stretched across the forms, or by running the screed over the forms and checking for any variation along the length of the blade. Check for lateral compliance by running the screed toward the center of the lane, stopping the screed at intervals and checking with a wire stretched from form to form. If the wire is not parallel to the bottom of the blade at both ends, adjust the screed and its supports on the carriage.
- Scraper attachments for keeping the top of form and wheels clean must be adjusted to remove all concrete. Failure to maintain clean contact surfaces introduces slight irregularities in the surface.

2-720C.2 Flexplane Float

The Flexplane float has transverse screeds to smooth and shape the surface and a rear-mounted, pan-shaped float for longitudinal finishing.

2-720C.3 Chevron Float

The chevron float is a V-shaped drag float that provides for transverse screeding as well as longitudinal finishing.

Attention should be given to the adjustment of the float. This channel section is flexible. When the machine is picked up and moved, it flops around and is easily sprung. The truss members are easily bent. Turnbuckles are built into the truss work, and they should be used to make adjustments. Never use a sledge hammer. All edges of the channel sections must be straight and smooth, and the screed should be adjusted so that the forward edge is slightly above the surface, while the rear edge appears to be slightly indented. On superelevated sections, the transverse setting of the float must be adjusted to compensate for the pavement slump.

2-720C.4 Tube Float

The tube float is a pipe tube about 20 ft. (6 m) long that is suspended diagonally across the paved lane on a carriage assembly, similar to the other finishing machines. This type of float is usually used with a slip-form paver.

2-720D Tining Machine

The tining machine applies a textured finish transverse to the centerline of the surface. The *Specifications* call for the tines to be 0.03in. (0.75mm) thick, 0.08in. (2mm) wide, and 4 to 6 in. (100 to 150 mm) long, spaced ½ in. (12mm) apart.

2-721 Final Preparations for Placement of Concrete

The mat reinforcement is placed along the forms, the forms are oiled, and all scuff marks are removed from the fine grade. The fine grade is moistened. The inspection team and testing equipment are assembled at the paving site.

When the concrete delivery starts, the batch tickets are signed by the supplier, and the discharge times are noted on each ticket.

The following sections describe the duties of the inspectors. Depending on the type of operation, the duties may be varied to ensure a smooth running, well-organized team.

2-722 Inspection Team

2-722A Concrete Inspector

The Concrete Inspector is responsible for the placing and finishing of the concrete. To satisfactorily cover each detail of the work, the Inspector will be very busy at times. However, if conditions warrant, the Concrete Inspector will be required to spend the major portion of the time with the paving operations. In addition, the Concrete Inspector may delegate the immediate responsibility for the inspection and control of certain operations.

If air-entraining admixtures are used, the Inspector must ascertain that the approved measuring device is in satisfactory working order and that a suitable supply of the admixture is on hand or is readily available. The Concrete Inspector must arrange for the inspector ahead of the paving equipment to check the fine grade with a subgrade template and to true up the form alignment, if necessary.

Cement having a temperature higher than 160 °F (71 °C) must not be used in the concrete. The temperature of cement at the plant must be measured and recorded at least four times daily. Concrete delivered in place must be at least 60 °F (15 °C) and must not exceed 90 °F (32 °C).

2-722B Paving Inspector

The Paving Inspector must check the following conditions.

- Forms, if used, are set at the correct line and grade.
- The transverse and dummy joint locations are properly laid out for a suitable distance ahead.
- The reinforcement, when placed, is not bent and is lapped the required distance.
- The batch or delivery tickets are properly received.
- The lower course and mat reinforcement is properly placed.
- The top course of concrete is placed within the allowable 45-minute interval.

The Inspector also is responsible for field testing the concrete for air content and slump and for casting test cylinders. Daily paving reports must be completed. The reports should show the roadway stations for the beginning and end of the placement, the quantity of the items involved, and the results of the field control tests.

2-722C Finishing Inspector

The Finishing Inspector must check all lutes and straightedges for trueness and all edging tools for size and wear. The Inspector should learn to use a straightedge in a manner that does not disturb the pavement surface. The Inspector straightedges the pavement along three points for the full length of each slab and has irregularities corrected. The Inspector should critically review the finishing of all joints and insist that the surface texturing operation be performed at the proper time, so that the desired surface finish and texture are attained. The Inspector must determine when the concrete cure operation should begin.

To identify each starting point, the Finishing Inspector must make up a brass tag showing the station and date of the beginning of the day's work. This tag is placed on the outside edge of the lane within the edged area of the first joint.

Immediately after the forms are removed from the previous day's run, the Inspector checks that all honeycomb is suitably patched and that the ends of the expansion joints are open to their full depth. When this work is complete, the Inspector checks that sides of the pavement are properly covered with the cure cover material.

The finishing work is the final control, and its results will be reflected in the appearance, durability, and riding qualities of the pavement. The finishing operation should keep pace with the placing operation. A satisfactory surface can be attained only if competent workers are able to perform their duties before initial set takes place.

2-723 Concrete Mix

As previously stated, if sources of the cement and aggregates are known, tested, and approved, the Division of Materials Testing will design a mix for the job.

2-723A Mix Adjustments

Any mix adjustments must be approved by the Laboratory.

2-723B Consistency

The consistency of the mix is important. Excess water greatly reduces the strength of the concrete and results in concrete outside the required slump range. If proper consistency is maintained, the finishing process can be carried out in a consistent manner.

For a central-plant-mix operation, concrete that is not placed within 45 minutes of the time of mixing, concrete that has developed initial set, or concrete that has a slump not in accordance with the limits established by the Engineer is rejected and disposed of outside the work.

2-723C Slump Test

Slump tests are made to help control the consistency of the mix during paving operations. The Inspector must make each slump test exactly alike so that the results are uniform.

Measurements of slumps are recorded to the nearest $\frac{1}{4}$ in. (6 mm) and are included in the CON-134 Inspector's Daily Report.

The first slump test should be made on the first or second truckload. Subsequent tests should be made at pavement intervals of not over 500 ft. (150 m). In addition, the Inspector should make tests anytime the batches appear to change consistency. If the concrete is too dry or too wet, the Batch Plant Inspector must be immediately instructed to make another moisture test.

To perform a test, a clean standard slump cone is placed on a dampened test board set on a level surface. The slump cone must be kept clean, smooth inside, and free of dents or other distortions. It must be moistened with enough water to wet the surface but not leave any free water. The cone then is filled with the concrete in three layers, each layer approximately one-third of the volume of the cone.

Each layer must be rodded with 25 strokes of a $\frac{5}{8}$ in. (16 mm) rod, 24 in. (600 mm) in length, bullet-pointed at the lower end. The strokes must be distributed in a uniform manner over the cross section of the mold and must penetrate into the underlying layer. The bottom layer must be rodded throughout its depth. After the top layer has been rodded, the surface of the concrete is struck off such that the mold is exactly filled. The mold is immediately removed from the concrete by raising it carefully in a vertical direction. The slump is measured immediately by determining the difference between the height of the cone and the height of the slumped concrete measured at the vertical axis of the specimen.

The allowable slump for paving mixtures should be kept as low as possible, consistent with workability of the concrete. The slump must be between $1\frac{1}{2}$ in. (38 mm) and 3 in. (76 mm) for side-form paving and between 1 in. (25 mm) and $1\frac{1}{2}$ in. (38 mm) for slip-form paving.

The Inspector must never accept ease of distribution as a reason for using mixes that are too wet to finish properly. Mixes that contain sufficient water to bleed and prevent proper finishing must be avoided, regardless of the measured slump.

2-723D Test Cylinders

Test cylinders are cast by placing fresh concrete in the mold in three layers, each approximately one-third the volume of the mold. The concrete is rodded with twenty-five strokes of the tamping rod. The strokes should be distributed in a uniform manner over the cross section of the mold and should penetrate into the underlying layer by 1 in. (25 mm). The bottom layer should be rodded throughout its depth. After the top layer is rodded, the surface of the concrete is finished to a true plane. Care should be taken in moving the cylinders to the curing box after their initial set. After standing for twenty-four hours, specimens are removed from the molds and cured.

2-724 Concrete Placement – Side-Form Paving

This section covers concrete placement using side-form paving methods and general paving information, such as placing concrete adjacent to transverse joints, paving adjacent lanes, and cold weather paving. The section, “Concrete Placement – Slip-Form Paving,” Section 2-725 covers concrete placement using slip-form paving methods. The section, “Finishing Pavement,” Section 2-726 covers finishing operations for both side-form and slip-form paving.

2-724A Side-Form Placement of Lower Course

Prior to the placing of any pavement concrete, the subbase and form alignment must be checked as previously noted, and the fine grade must be suitably sprinkled. The sprinkling of the fine grade should be carefully observed. Workers often do not realize the importance of this operation, and they are apt to become careless and fail to properly take care of the work. Immediately after the fine grade has been sprinkled, a worker should clean the subbase adjacent to the forms to ensure that the bottom is exposed at all points. This is an important step in attaining the required depth at the pavement edges. All scuff marks should be removed from the fine grade.

The operation of depositing and spreading must be continuous between transverse joints. In case of an unavoidable interruption, a joint should be formed at the point at which the work stops, provided that the section on which the work has been suspended is at least long enough to permit one mat of reinforcement to be placed. Shorter sections should be removed.

Covers for all underground structures should be set accurately to grade. Care must be exercised to place the covers such that they will conform as nearly as possible to the finished contour of the pavement. To accomplish this, the cover grade should be set by a string line drawn taut between the forms or between the finished lane and the form. The center of each end of the cover should be held to a point 1/8 in. (3 mm) below the line.

2-724B Spreading

The concrete should be deposited on the subbase as rapidly as possible, and every effort should be made to avoid breaking the continuity of the successive batches placed. The concrete must be reasonably distributed as it is dumped onto the subbase. If successive batches are dumped in piles, unequal settlement of the materials occurs in the vicinity of the piles, which is reflected in the finished surface.

The Inspector should note the condition of the concrete.

- It should be in a plastic condition and have the appearance of a homogeneous mass.
- There should be no indication of segregation.
- There should be no free water along the edges of the pile.

The concrete should be deposited on the subbase in a manner that requires as little rehandling as practicable. The bottom layer should be struck off to the required grade to receive the mesh or bar mat reinforcement, again with a minimum amount of handling. The operation should be performed with an approved mechanical spreader or with shovels. The use of rakes or any other type of equipment that causes segregation should not be permitted. If the concrete is placed along the forms with shovels, the workers should be instructed to turn the shovels over as they place the concrete, so that the backs of the shovels are toward the forms as the concrete leaves them. This procedure helps minimize honeycomb along the edges of the lanes, particularly where the horizontal key prevents easy spading.

2-724C Consolidation

An immersion vibrator should be used for consolidating the concrete. It should have a frequency of not less than 3500 impulses per minute. Avoid contact with the forms and load transfer assemblies when vibrating. Do not allow the vibrator to be held in one spot for more than 10 seconds. Pay particular attention to the transverse expansion-joint units. Watch for displacement of the dowels from the longitudinal joint-support units.

Because of the obstruction caused by the horizontal key, the concrete placed adjacent to the form supporting it must be consolidated by use of spades or an immersion high-frequency vibrator. This operation should be carefully observed because lack of or improper vibration results in objectionable honeycomb adjacent to the key. The Inspector must see that the operator does not over-vibrate and does not leave the vibrator unattended while it is in operation. When the forms are removed the following day, the edges of the pavement are observed for honeycomb. All honeycombs should be immediately patched with mortar.

2-724D Placing Concrete Adjacent to Transverse Joints

Placing concrete adjacent to transverse joints must be done with care to avoid moving, tipping or damaging the joint assembly. Technological changes in the design and operation of concrete placing and finishing equipment have helped to eliminate many of the problems associated with the placement and consolidation of concrete at transverse joints. However, the following precautions and restrictions should be followed.

- If discharging directly onto the subgrade from trucks, do not allow the concrete to drop on or against expansion joints or contraction joints with attached joint forming strips as it invariably knocks the assemblies out of line. The concrete should be deposited on the subbase as near to the respective joint as practicable.
- Consolidation of the concrete at all transverse joints is essential to the proper functioning and finishing of the concrete. Careful spading or vibrating around the joint and load-transfer units helps to ensure a good joint.
- Spreading equipment that employs a traveling distributing arm or rotary screws to strike off the concrete placed within the forms should not be allowed to work close to expansion- or contraction-joint units. The Inspector should observe the forward movement of the concrete to determine just when the machine should stop.
- At all expansion-joint units and at some strip-type contraction-joint units, the spreading machine should be stopped while the height of the distributing device is reset. When going from one slab to the next, some operators attempt to judge the location of the joint and begin lowering the spreading device without stopping the forward motion of the machine. The procedure often moves or damages the joint.

2-724E Reinforcement

The reinforcement for concrete pavement consists of either fabric reinforcement or bar-mat reinforcement. Samples must be submitted to the Laboratory and approved before use. The details of the design and method of spacing and lapping, together with the location of the reinforcement, are indicated on the standards. The Inspector should thoroughly examine the standards, to obtain a full understanding of the requirements, as well as knowledge about the manner in which the reinforcement should be placed.

After the first layer of concrete is screeded to the desired level, the mats are set in the concrete at the elevation shown on the plans, placed in the center of the lane, and lapped the required 14 in. (360 mm) with the preceding mat. If any of the members are bent, they should be straightened out before placing the mat. If the screeding has been properly performed, it is not necessary to stamp the mat into its proper position.

The Inspector should carefully observe the placement of reinforcing steel to ensure the mats are properly lapped and placed at the required elevation and that they are not disturbed by the forward motion of the spreading machine or screed. It must be particularly observed that no bars are bent upward at lap points. The mat reinforcement should extend to within 2 in. (50 mm) of all transverse and longitudinal joints.

If mats are prefabricated off site due to site constraints the Project Inspector should have a discussion with the contractor regarding the fabrication and subsequent mobilization to the project site. Upon arrival the mat should be inspected for any damage that may have occurred during the delivery including bent or destabilized reinforcing steel.

To prevent the mats from being carried ahead by the forward motion of the screed or spreading machine, they should be placed such that the mat to the rear laps over the forward mat. The position of the mats should be checked occasionally by digging down with a trowel after the final screed has passed to see that the mats have not moved. If the mats have moved, they could be located directly above the load transfer device, thus destroying the intended weak plane. If using bar-mat reinforcement, C-clips should be used to tie the mats together between contraction joints.

Any portion of the bottom layer of concrete that has developed initial set or has been in place longer than 45 minutes without being covered by the top layer must be removed and replaced with new concrete. Otherwise, there is a risk of creating a plane of separation between the bottom and top layers of concrete at the elevation of the reinforcing; the plane reduces the strength of the pavement. The initial set and time limit for the bottom layer can be used to govern the distance between pavers in a two-paver operation.

An alternative method of placing reinforcing is to vibrate the mat into the full depth of concrete by an approved machine. The equipment manufacturer's procedure is used.

2-724F Side-Form Placement of Top Course

The concrete being discharged from the trucks or equipment hoppers should be spread evenly over the lower course, not placed in piles. The forward screed of the strike-off machine should carry a small surplus of concrete. Avoid overloading the screed.

The concrete carried by the rear screed should not be excessive. If carrying surplus material, this screed has a tendency to float, so that the surface is not even with the forms. If a surplus accumulates, have the machine move ahead on the forms and lose it. Then back it up and make another pass. More than two passes of the strike-off machine should not be required. If, after the second pass, the surface is still high or rough-looking, review the concrete placing operation.

2-724G Paving Adjacent Lanes

2-724G.1 Equipment Operation

Paving operations that require operating equipment on the older lane are not allowed until the required structural strength is attained. The strength is determined by the compressive strength obtained for test cylinders for the section of pavement in question. The operation of all equipment on the older pavement must be so that no marking or chipping of joints and longitudinal edges occurs.

Flat, rubber-tired wheels must be used in place of flanged wheels if finishing and spreading equipment travels on the concrete. If heavy equipment is operated or moved on concrete pavement, secure the maximum protection to the longitudinal and transverse edges. Center the equipment in the pavement width.

Do not permit equipment to travel up to a transverse joint and stop. Instead, the equipment should be stopped at a point such that its load is somewhat equally distributed on both sides of the joint. To protect the surface of the pavement from abrasion, the paver must be operated on wooden mats having thicknesses

of not less than 2 in. (50 mm) or on suitable fiber belting at least 1 in. (25 mm) thick and 2 in. (50 mm) wider than the width of the treads.

Caution the contractor that breaking or spalling of the concrete edges due to operation of equipment on or adjacent to the new concrete is not acceptable and must be repaired at the contractor's expense, as required in the *Standard Specifications*.

2-724G.2 Longitudinal Joint

If the expansion joint filler was notched on the completed lane to fit around the longitudinal keyway, remove all concrete from the recess and carefully install a properly shaped piece of expansion material. Locate the edge of the inserts. Be sure the ends butt and the joints are straight. Be certain all of the longitudinal joint support units are installed. Insist that the top surface of both lanes along the longitudinal joint be at the same level. Caution the finishers during the edging operation to keep the longitudinal joint as narrow and tight as possible.

2-724H Construction Joints

In case of a breakdown or long delay where a regular joint cannot be formed, install a construction joint. The minimum length of pavement allowed is one mat length. Longitudinal-joint tie bars, rather than transverse contraction or expansion joint units, should be placed at intervals of 2½ feet (0.75m) or less across all transverse construction joints. In normal operations, a reinforced expansion-joint unit is customarily used at the terminating point of a day's pour as the bulkhead.

2-724I Cleanup

When paving operations are completed adjacent to a paved lane, but before the curing mats are placed, the edge of the adjacent lane should be cleaned of all excess material that would cause unsightly appearance or an irregular surface. The cleaning may be accomplished with shovels and brooms.

If the adjacent lane is still under cure, have the covers carefully replaced. If membrane cure is being used, the disturbed work area should be given another application of the cure compound.

2-724J Cold Weather

Cold weather procedures are used from October 15 to April 15, unless the Engineer directs otherwise. The procedures are in Article 6.01.03-12 of the *Standard Specifications*, covering structural concrete.

The temperature of the concrete must be no less than 60 °F (16 °C) when placed in the forms. The temperature surrounding the pavement must be kept above 60 °F (16 °C) for five days after placement, above 40 °F (5 °C) for an additional nine days, and then gradually lowered to the ambient air temperature. Mixing water must be heated, but its temperature cannot exceed 150 °F (65 °C). If aggregate is heated, its temperature must be between 50 °F and 100 °F (10 °C and 37 °C). The Engineer may vary the temperatures for the mix, water, or aggregate in extreme weather.

Every precaution must be taken to protect the concrete from freezing. If it is expected that the temperature will drop below 35 °F (2 °C) during the curing period, the concrete is cured using one of the approved methods. Then a layer of hay or straw 6 in. (150 mm) to 8 in. (200 mm) thick is placed on the concrete, and a layer of mats or cover sheets is spread over the hay or straw. The edges of the mats are firmly fastened in place. The covering remains in place until no further protection is needed.

The *Standard Specifications* state that any concrete placed during cold weather is done at the contractor's risk, and damaged sections must be removed and replaced at the contractor's expense. However, if in doubt as to whether paving operations should be started or resumed, consult the Assistant District Engineer.

2-725 Concrete Placement—Slip-Form Paving

2-725A Slip-Form Spreader Operation

The spreader places the concrete to the depth of the mat reinforcement, 2½ in. (65 mm) below finish grade if the concrete is placed in two layers. The placement width is approximately 6 to 12 in. (150 to 300 mm) less than the lane width. The remaining part of the slab is filled in by the paver when the top course is placed. Some important points are below.

- The subbase must be thoroughly moistened directly ahead of the spreader to prevent rapid loss of water from the concrete, to a depth of at least 1 in. (25 mm).
- Care must be taken to see that the correct quantity of concrete is placed; too much will overload the following paver, and too little will result in having to halt the paving while additional material is added.
- The interval between the spreader and paver is important; the distance should be kept as short as possible because the concrete will set in about 20 minutes.

The reinforcing mats are placed immediately behind the spreader. They are placed from a mesh cart or from previously distributed piles along the roadway. The mats must be overlapped 14 in. (360 mm) in the direction of travel, and the sheets should be locked together to prevent dragging by the paver or depressor. Locking is by bending two or three wire ends around a transverse wire in the preceding mat. If bar mat reinforcement is used, C-clips should be used to lock the mats together. The mats should be placed so that the transverse wires are up, to prevent depressor bars from breaking the wire welds.

If placing the concrete in two layers, the second course is placed in a windrow on the center of the reinforcement. The concrete should be placed so as not to shift the reinforcement laterally. The windrow helps to hold the mats in place when clipped together and lessens the possibility of being dragged by the paver.

2-725B Slip-Form Paver Operations

The paver is the most important piece of equipment in a slip-form paving train. It is directly responsible for the riding quality, thickness, and cross section of the finished pavement. Errors made by the paver are practically impossible to correct; therefore, constant inspection of the machine is an absolute necessity.

2-725C General Inspection

During operation, the Inspector should check for the following:

- steel depth is correct,
- pavement thickness is correct,
- vibrators are working,
- screed board is allowing sufficient material to pass to carry proper surcharge ahead of screeds,
- longitudinal joint-support units are inserted at proper intervals,
- float pan is leaving the desired surface,
- pavement edges are vertical, square, no honeycombing, and
- pavement width and template are correct.

2-725D Paver Speed

The paver should travel at the slowest possible forward speed that the screeding action allows. The concrete must be consistent in slump (1 to 1½ in. [25 to 38 mm]). The slow forward speed allows the edges to stay in the slip form longer for support, allows the longitudinal joint assemblies to be inserted squarely, and prevents the mat reinforcement from dragging.

2-725E Paver Movement

A smoother pavement results if the paving can be done without interruption than if the paver must stop due to lack of concrete, difficulty in steel placement, or other delays in the paving cycle. Each paving project should be examined for proper balance between mix production, delivery, and lay down, so that the operation can proceed smoothly and orderly.

Moving forward at a very slow rate is preferable to stopping. The operator should anticipate foreseeable delays caused by lack of concrete and slow the machine to reduce the number of times it must be stopped.

2-725F Base Irregularities

If running with one string line or running locked to grade, it is very important that the paver tracks move on a smooth surface. Bumps will be reflected in the finished pavement. It may be necessary to assign a laborer to clear spilled concrete from the track path.

The possibility of base irregularities showing up in the surface depends on the paving machine's length of skid and the closeness of the irregularities. In many instances, the skid is able to bridge across irregularities, and they do not show up on the surface. Subbase irregularities that produce variable concrete thickness do not necessarily result in decreased yield. The irregularities can balance themselves out such that the overall yield is not affected.

Slip-form pavers use their own weight (up to 20 tons [18 metric tons]) to mold the plastic concrete into the correct shape. As a result of this extreme load on the subgrade and base materials, consolidation of the base materials may cause undulations to appear on the pavement surface. If the embankment is compacted uniformly, each area of the grade is compressed an equal amount. However, around drainage structures having minimum cover and bridge approaches, adjacent sections of the subbase are unequal in compressibility. The sensing units detect the settlement of the paver, but due to a time lag in actual response of the screeds, the adjustment always is too late to balance the settlement with increased slab thickness. This causes undulations that may not be detected by a 10 ft. (3 m) straightedge. Even though not detected by the straightedge, they affect pavement roughness as measured by the profilograph.

Shoulder areas require additional care in their construction. Concrete batch trucks ride the shoulders and quickly cause soft areas to distort. The areas affect the smooth flow of truck deliveries and may cause the paths for the paver to be unstable.

2-725G Mix Consistency and Quality

The mix should be uniform from batch to batch. Edge slumping occurs if the concrete's slump is in excess of 1½ in. (38 mm). (The standard mix probably will be changed to accommodate the paver being used.) If the mix does not have enough water, depressions occur around the transverse joint ties. The mix does not flow readily around the steel cage, causing a depression extending approximately 4 ft. (1 m) long in back of the joint. The depression is easily found by straight-edging.

A sandy mix is quickly identified. The roll in front of the spreader or paver has areas with large amounts of mortar that appear to remain stationary. Another sign is tearing of the pavement surface behind the

finishing machine. Concrete that is on the sandy side of the design mix helps the edges stand without sloughing.

2-725H Edge Slumping

Edge slumping usually is caused by excessive water in the concrete mix. However, it may be caused by improper vibration frequency of the finishing screeds or by operating the vibrators when the paver is stopped. The roll in front of the paver may become too high or too low from time to time. The height of the roll should be corrected by changing the speed of the paver. Controlling the roll height by varying the height of the strike-off screed manually is unsatisfactory, as it causes pavement roughness.

2-725I Consolidation

Proper consolidation of the concrete is obtained by the action of several vibratory elements. Improper frequency is rarely a problem because the frequency of the vibrators is set at the factory and most machines do not have the ability to vary it. However, the amplitude of the vibrators is variable and can be controlled by the operator. The proper amplitude vibrates the concrete at least 12 in. (300 mm) from the vibrating element.

2-726 Finishing Pavement

2-726A Hand Finishing

The number and ability of the finishers must be adequate. These workers must be experienced and capable. Correction must be made, if there is an insufficient number of finishers or if they are not capable of satisfactorily completing the work as required. Finishing operations must keep pace with the placing of the concrete, and all other pavement operations must be geared accordingly.

2-726B Finishing Machine

As soon as the full depth of the concrete is spread to approximate uniform elevation, it is struck off by the finishing machine. A slight excess of concrete must be maintained ahead of the transverse screed to ensure cutting action at all times. Material must not pile up in front of the forward screed so that there is a heavy flow under it. Too much material tends to lift the screed above the forms, while too little leaves low spots on the surface. Depressions or torn areas that develop in the surface must be filled at once with fresh concrete. Mortar or material picked up outside the forms must not be used for filling depressions.

There often is a tendency on the part of the operator of the transverse finishing machine to make too many passes over the surface, with the result that excess mortar accumulates on the surface. This weak, segregated material must be floated over the forms. The Inspector must never allow the material to be carried ahead to the transverse joint. Do not allow any wet mortar to be deposited along the slab edges. Special care must be taken to see that good quality concrete is always used along the edges and joints, because they are subject to the greatest stresses. If added mortar is used in the finishing of the edges and joints, the pavement will be defective.

In general, the transverse finishing machine should not make more than two passes. The Inspector should never allow an excess of concrete (8 in. [200 mm] or more) to pile up in front of the forward screed. The equipment should be operated so that it moves forward slowly at a uniform speed and should not stop in the section being screeded. The rear screed should carry a roll of concrete not more than 2 to 3 in. (50 to 75 mm) deep. If it is deeper than that, excess material is flowing under the forward screed.

If air-entrained concrete is being used, there is little sedimentation or bleeding and, thus, very little free water for surface lubrication during finishing operations. Sometimes as a result, the concrete adheres to the finishing-machine screeds, causing a torn surface. The tearing usually can be overcome by increasing the rate of screed oscillation. If the air temperature is high and there is a drying wind, it is very important that the hand-finishing operations follow closely behind the finishing machine. If this is not done and a flash set occurs before the final finishing and edging are completed, a poor surface will result.

Operation of the transverse screed must be carefully observed up to and over the transverse joint. Do not allow the screed operator to bring up an accumulated roll of mortar on the rear screed and deposit it into depressions around the transverse joint. Do not allow the screed operator to pass over the joint with a large amount of concrete carried on the front screed.

Instruct the supervisor to have the large accumulation of mortar and concrete removed before screeding is carried over the joint. Depressions at the joint must be filled in with good unsegregated concrete. Never allow the use of mortar in filling depressions, whether it is at a joint or elsewhere in the pavement.

The tops of the forms and the wheels of the finishing machine must be kept free of concrete. Inspection of the shoes or wear plates should be made at least once daily to ensure that they are not worn sufficiently to affect the cross section of the pavement.

2-726C Longitudinal Floats

The *Standard Specifications* provide for longitudinal floating as soon as possible after the concrete has been consolidated by the transverse screed. The *Specifications* require that the longitudinal float be mechanically operated. Where mechanical longitudinal floating cannot be done, a hand float must be provided and used.

There are four basic types of equipment currently in use: the longitudinal or bull float, the Flexplane type of drag float, Lewis type of chevron float, and the tube float.

2-726C.1 The Longitudinal Float

The longitudinal float, or sometimes referred to as the bull float, should operate within 100 ft. (30 m) of the transverse screed. The distance may vary, however, because of weather that causes excessive drying, excessively humid weather, or variations of the mix. In general, it is desirable to delay the operation until the surface has started to dry out slightly, so that some settlement has begun to take place. It is not desirable to delay the operation too long because the concrete will be too dry for the final finish work.

When properly operated, the screed should carry a small roll of concrete along all but about the rear 24 in. (600 mm) of its length. The roll is largest at the forward part of the screed and tapers off toward the rear half of the screed.

If the concrete is of the desired consistency, it rolls rather than flows. If the roll is small, say less than 1½ in. (40 mm) in diameter, the screed may be lifted as it reaches the form, and the roll of mortar picked up for the return pass. If the roll grows larger than this, or if the material flows in front of the screed, it is to be wasted over the forms. The forward speed of the longitudinal float should be regulated so that, if necessary, two complete passes can be made over each area. The operator must continuously observe the amount of mortar being carried by the screed. The material must be distributed along the length of the screed and must not roll off the rear to form a ridge. The operator should force down any large aggregate that might tear the surface.

2-726C.2 The Flexplane Float

The Flexplane float has transverse screeds to smooth and shape the surface, and a rear-mounted, pan-shaped float unit to provide for the longitudinal finish.

The float should have a slight front-to-back tilt, exert a slight amount of pressure on the surface, about a 1/8 in. (3 mm) crown at the center, and be free of nicks and dents. The finished surface should be smooth and free of all finishing marks.

2-726C.3 The Chevron Float

The chevron float is a V-shaped drag float that provides for transverse screeding as well as longitudinal finishing. The float component is suspended from the rear of the machine. It consists of two sections of a trussed 12 in. (300 mm) wide channel section, each about 12 ft. (3.5 m) long, jointed at the front to form a "V." The flat surface of the channel is placed in contact with the screeded surface, and the forward travel of the machine drags it over the surface, smoothing out all remaining marks.

The amount of concrete carried by the two transverse screeds should be held to a maximum 5 in. (125 mm) diameter roll for the forward screed and a 2 in. (50 mm) roll for the rear screed. If you note a buildup of concrete on the screeds, the material should be wasted, the machine backed up to where it appears the surface is to grade (a string line pulled across the forms will help confirm this), and another pass made.

A check should be made to determine if a localized high spot was the reason for the screed buildup, or if the forward transverse screeding machines are leaving too much concrete. If the concrete has a tendency to roll down at the forms, again check the surface with a string. The operator might have raised the screeds to cover up a high spot. This shows up as a dip along the longitudinal joint. Watch the action of the end pans. They are hinged and float easily.

2-726C.4 The Tube Float

This type of finisher requires extremely good grade control and surface finishing by the screeds on the top course strike-off machine on the slip-form paver.

As the finishing machine moves longitudinally, the tube smooths the wet concrete surface. Excess concrete is pushed ahead of the tube and, because of its diagonal orientation, eventually rolls to the edge of the lane. Two passes of the float usually are required for a satisfactory surface finish. If more passes are required, check the adjustment of the top course strike-off machine. As in normal concrete paving, overworking the surface should be avoided. The spray bar should be used sparingly to keep the float from dragging.

The most important consideration with this machine is that the float or burlap drag should only be raised or lowered when the machine is in motion. Stopping the finisher prior to raising the float or drag results in a ridge of material that is extremely difficult to remove.

2-726D Luting

All small irregularities and the longitudinal screed trail must be removed immediately after the surface is consolidated. The *Standard Specifications* provide for the use of a manually operated smoothing lute or striking straightedge of approved type and dimensions to follow the longitudinal floating operation. The lutes must be equipped with either an aluminum or steel blade, 10 ft. (3 m) long. The use of paddle-type lutes to finish pavement should not be permitted.

At the beginning of the day's work, the lutes must be lapped back at least 5 ft. (1.5 m) on the preceding day's pavement and then moved slowly over the surface of the concrete from one side to the other. Movements longitudinally must be made by raising the lute completely above the surface and lifting it ahead not more than half its length or by sliding it along the form the same distance.

Luting should eliminate all finishing machine marks and remove all small irregularities. The lute should barely scratch the surface, except where high spots occur. For low areas, fresh concrete should be carried

back, spread in the low area, hand floated to the correct grade, and smoothed with the lute. The luting operation should be carried across all joints as if they were not present. At the end of the day's run, considerable care should be exercised in luting the area over and adjacent to the final joint.

If the finishing machine operations are carried out correctly, the surface should be smooth enough so that very little luting is required. Often a finisher has the tendency to do too much floating, and the Inspector should insist that only enough of it is performed to ensure a smooth texture of surface that will straightedge properly.

As mentioned previously, the use of paddle-type lutes to finish the pavement surface should not be permitted. However, a float suitable for cutting excessive high spots or floating fresh concrete placed in low spots should be available.

2-726E Joints

2-726E.1 Expansion Joints

Immediately after the surface has been luted, a pointed trowel should be run along each side and to the full depth of the protection cap. (Figure 2-7.6 shows an expansion joint.) The cap is removed and a spring-steel strip equal to the width of the joint is carefully placed on the filler. It is important that the joint is finished with the material originally deposited adjacent to the joint. Never allow the finisher to remove the coarse aggregate and substitute mortar or segregated material to facilitate finishing.

When the spring-steel strip has been placed, the concrete adjacent to it is thoroughly consolidated, floated and given a preliminary edging. On completion of the preliminary edging, the joint is checked with a straightedge designed to check joints. The blade of this straightedge may be of wood at least 4 ft. (1.2 m) in length, 4 to 5 in. (100 to 125 mm) high, and 2 in. (50 mm) wide. It must have a 14 ft. (4.3 m) handle attached and a notch in the center of the cutting edge, so that it can ride over the spring-steel strip and so that the pavement on either side of the joint can be properly checked.

The steel strip is removed carefully so that the concrete adjacent to the joint is not disturbed. The removal of the steel strip should leave the top of the joint filler fully exposed. The finisher should run a pointed trowel, held vertically, along both sides of the filler. This ensures that the joint opening is directly over the filler and that the vertical sides do not overhang any part of the filler.

The importance of the proper installation and finishing of each transverse expansion joint cannot be overemphasized, as poor workmanship will result in pavement spalling and rough riding conditions. The Inspector must be present at the installation, finishing and straight-edging of every joint installation made throughout the day. Extra efforts must be taken with the preliminary straight-edging, as any correction found necessary at or adjacent to the joint after the final edging has taken place will generally result in an unsatisfactory joint.

When the forms are stripped, the joints should be inspected to see that there is no grout around the ends or on top of the expansion material. Remove any immediately after the removal of the forms.

Do not permit the use of caps or spring-steel strips that are bent or deformed in any way. See that the caps are clean of hardened concrete that may prevent the cap from resting on the joint for its entire length. Do not permit the joint finish to be overworked.

2-726E.2 Contraction Joints

Forming of the transverse contraction joint groove over the previously placed load transfer assemblies follows the longitudinal finishing equipment. The grooves may be formed either by using steel strips or by saw cutting. (Figure 2-7.7 shows a contraction joint.)

For 9 in. (230 mm) concrete, a $\frac{1}{4} \times 2$ in. (6×50 mm) strip of steel may be manually inserted into the steel guides attached to the load transfer assembly. The strip should be as wide as the lane, clean of all foreign material, free of kinks, and straight. The strips are very limber and flexible and are easily distorted. They should be installed so that the tops of the strips are $\frac{3}{4}$ in. (19 mm) below the finished surface.

The strips can be installed after the lower course has been placed. Bridges must be placed across the forms at each joint and a trowel used to remove enough concrete so that the strips can be installed. Do not allow the workers to walk in the fresh concrete or use sledge hammers to straighten kinked strips. The concrete that was removed should be replaced, and the new material consolidated and smoothed off with a float.

In the second method, the contraction joint groove is cut with an approved concrete saw. Adequate water and lighting equipment must be provided before sawing operations begin. At all times during the sawing operations, there must be available on the project at least one standby saw in good working order and an ample supply of saw blades.

Positive methods, subject to the approval of the Engineer, are employed to assure that the sawed groove is centered directly over the transfer unit from edge to edge of pavement. Reference stakes or nails should be used. Contraction joint grooves must be sawed normal to the pavement surface, true in alignment, at the intervals and to the minimum depth and width specified or approved.

It is the contractor's responsibility to perform all joint sawing operations at such times and in such sequence as to preclude unsatisfactory results due to uncontrolled cracking or excessive raveling. The time of sawing depends on existing and anticipated weather conditions and must be such as to prevent uncontrolled cracking. Time of sawing is particularly critical at contraction joints in lanes adjacent to previously constructed lanes. Normally, all transverse joints are sawed as soon as possible and in consecutive sequence. If climate or other conditions warrant, the contractor may deviate from normal.

If a crack has developed, sawing should be omitted at the joint location. Otherwise, sawing should commence as soon as the concrete has hardened sufficiently to permit sawing without excessive raveling. Once started, the sawing operations must not be stopped, except for raveling or uncontrolled cracking.

Immediately upon completion of sawing a joint, it is thoroughly cleaned with air (when dry cutting blades are used) or with water (when wet cutting blades are used) until all dust or slurry has been removed. If found necessary, the sawed joint must be cleaned again immediately before being sealed.

2-726E.3 Transverse Joints

A 10 ft. (3 m) metal straightedge placed at right angles to the joint should show no variation over $\frac{1}{8}$ in. (3 mm) in the surfaces of adjacent slabs. Edging of joints should be carefully inspected, particularly for maintaining a true grade across the joint. Particular attention should be paid to the finishing and edging of the joint that occurs at the beginning of each day's run so that the grade of slabs matches just before final texturing. This edging should be done at a stage when the surface is dry enough to prevent any settlement under the weight of the tool, but not before initial set.

2-726F Straight-edging

After the luting has been completed, the surface must be systematically checked for smoothness with a 10 foot (3 m) straightedge. Straight-edging is performed over the entire length of the slab and along three points in width while the concrete is still plastic.

The more common type of straightedge in use today consists of an aluminum blade, different in shape from the lute, 10 foot (3 m) long, mounted on a long handle. The straightedge should be checked frequently and, when not in use, it should be placed where it cannot be injured. The straightedge should never be used for luting or floating.

Care must be taken to see that the straight-edging is done at a stage when the surface is dry enough to prevent any settlement under the weight of the tool. If the concrete is too soft, the blade of the straightedge will sink into the surface, thus reducing the possibility of detecting minor variations of 1/8 in. (3 mm) or slightly over. If straight-edging is delayed too long and the initial set takes place, the resulting delay in the final finishing operations often causes a bad section of surface finish and joint work. The Inspector must be alert to this condition, particularly on a hot, dry day. The Inspector should not permit water to be sprinkled on the surface of the concrete to facilitate finishing, because it causes scaling.

The contractor should perform the work by lowering the straightedge very carefully onto the concrete, so as not to mark the surface. All variations in the contour of the pavement surface of more than 1/8 in. (3 mm), as shown by the straightedge, require adjustment. Where adjustments are required, the Inspector must ensure that all irregularities are removed and the surface is properly floated.

High spots usually can be removed by the lute. Low spots should be brought to grade by placing fresh concrete in the depression and having the lute man strike off and smooth the surface. Straightedge all corrected areas. Pay particular attention to the transverse joints. Straightedge diagonally, as well as conventionally, to detect any unevenness. When starting a new pavement section, lap the tool back on the completed work at least one-half the blade length.

Shortly after curing mats or paper are removed from the pavement, the Chief Inspector should make immediate arrangements to have the cured surface straight-edged. This inspection should be made without delay. When irregularities exist that reveal inferior workmanship, immediate corrective measures can be taken.

2-726G Tining

The surface texture is done by steel tines as soon as the concrete allows transverse grooves, 1/8 to 3/16 in. (3 to 6 mm) deep and 1/2 in. (12 mm) apart without tearing the surface or filling in the grooves. The grooves are placed across the entire width of the pavement, perpendicular to the centerline.

2-726H Edging

After luting is complete and before edging the sides of the pavement, a trowel should be run along the edges of the slab to free the concrete adjacent to the forms and expansion joints and to facilitate use of the edger. Then the edging tools should be worked along the edge of the lane, preparatory to the final tooling.

If the concrete is too soft when the edging work is done, the rounded corners become refilled, causing an unsightly edge. If edging work is delayed until the concrete has hardened, the bond is disturbed and it is difficult to secure a good finish.

Good edging tools must be used to help ensure edging uniformity throughout the job. Often the concrete finishers are loath to part with a worn edging tool, as such a tool offers little resistance and is easier to

operate. The Inspector, therefore, should make frequent checks of the tools to see that the required radius is not distorted or entirely worn out, and should ensure that the contractor has a sufficient supply of edging tools on hand so that immediate replacement of worn tools can be made when necessary.

The Inspector must insist on uniform edging work. The radii must be true and the troweled surface uniform and in a plane with the slab surface. Tipping the edging tool causes an objectionable burr or depression and must be avoided. Likewise, stone encountered in the edge area must not be traveled over with the flange of the edger. If a piece of stone in the concrete is encountered, it should not be removed and replaced with mortar scraped from the surface or form; rather, it should be tamped below the required grade and the resulting depression filled in with fresh concrete and smoothed.

If it is necessary to hand-float the edges, some correction of the preceding operation is needed. Check the machines and method used in the prior work. It is particularly important to secure a true edge on the lane that will act as a form for an adjacent lane, so that the finishing machines will have a true surface to ride on.

Many of the current contracts do not require that the longitudinal-joint recess be filled with joint seal when the pavement is constructed on a single-lane basis. Smooth-riding longitudinal joints can be realized only if the joint recess is in accordance with the plan dimensions and shape and the edges of the abutting lanes are correct.

2-727 Curing and Protection

Curing is required to protect the concrete from rapid drying by preventing the loss of moisture through evaporation. Moisture is needed so that the water and cement can complete their chemical reaction and to protect concrete from shrinkage. Curing is done after the final finish. There are three acceptable curing methods: moist curing, membrane curing and polyethylene cover-sheet curing.

The wheels of paving equipment usually have flanges. When paving adjacent lanes, check to ensure that the flanges do not strike and spall the concrete along the longitudinal joint. During the curing period, do not allow the forms or form pins to be placed on the surface. Walking on the surface should be discouraged.

2-727A Moist Curing

Quilted covers, if kept saturated, provide the required protection by permitting evaporation of water from their top surfaces. The dimensions of the mats must conform to the requirements of the *Standard Specifications*. They must extend over the sides to cover the edges of the pavement. As soon as the forms are removed, the mats are placed so as to fully cover the top and sides of the concrete and, if necessary, are held there by weights to prevent the wind from disturbing them. Each mat must be lapped at least 12 in. (300 mm) on adjacent mats. Mats that are torn or frayed or in which the lining is lumpy must not be used.

Curing must begin as soon as the finishing operations are completed and the concrete surface is set up enough to withstand marring by curing mats. During hot, drying weather, finishing must be completed and the curing material must be placed before the surface dries out to the extent that hairline cracks appear because of early shrinkage. The concrete surface is particularly susceptible to hairline cracking on a hot day that is accompanied by a stiff breeze. Under these conditions, a very close watch should be kept on the concrete and, at the very first signs of hairline cracking, the curing mats should be placed over the surface, even if the surface has not set up enough to resist marring.

Curing mats must be wet enough so that the side adjacent to the concrete remains damp. Dry mats absorb and tend to draw water out of the concrete, preventing proper curing. Do not place dry mats over the concrete, even though promises are made that they will be wet immediately afterward. This does not work

out, as usually the amount of water sprayed on the mats is not sufficient to soak through to the bottom of the mat. Insist on the mats being damp before placing over concrete.

Wet blankets are heavy, and caution must be used to avoid dragging them over the surface when placing them. A blanket must be placed by unrolling it from a 2×4 (50×100) or by four workers carrying the blanket by the corners and lowering it carefully onto the concrete surface.

After mats have been placed, they must be immediately saturated and kept saturated with water throughout the required period, as prescribed by the special provisions of the contract or in the *Standard Specifications*.

The Inspector should check occasionally during periods of exceptionally hot, drying weather by turning blankets up to see if the lower side is wet. Even with an apparently wet surface, from regular sprinkling, the bottom may be dry.

2-727B Curing Compound

The curing compound must be white, pigmented 100-percent resin-based material or a water-soluble, linseed-oil-based compound. Both types of curing compounds must be sprayed uniformly over the surface by a self-propelled mechanical sprayer. The resin-based material must be applied as soon as the free water has disappeared, while the linseed-oil-based compound should be applied immediately after the finishing operation.

The Inspector should assure that the minimum coverage requirements are obtained by checking the gallons (liters) used against the square yards (meters) covered. The joints must be protected so that the curing material does not adhere to the edges of the joints, causing possible failure of the joint sealing compound. The surface should be checked during the curing period to ensure that no abrasion has occurred that would decrease the moisture-retaining qualities of the material.

The usual application rate is 1 gal./150 sq. ft. (0.3 L/m^2). Cover sheets should be available on the project to protect the pavement from rain or for use if equipment breaks down. The equipment used for applying the material should be equipped with a device that provides for adequate agitation of the compound to prevent settlement of the coloring pigment.

When the side forms are removed, all honeycombed areas should be patched before the edges are spray cured.

2-727C Polyethylene Cover Sheet Curing

Polyethylene cover sheets must be placed in such a manner that the surface of the concrete is not marred. The adjoining covers must overlap at least 12 in. (300 mm), and the lap must be securely weighted down to form a closed joint. Before reusing polyethylene covers, they must be checked for rips or tears, and repairs must be made if required.

In the event that checking develops before the cover sheets can be placed, the normal procedure is modified at the direction of the Engineer. Moist curing mats must be used for the initial 24 hours of the curing period, and the cover sheets must be placed for the remainder of the curing period.

On removing forms, the edges must be covered down to the bottom of the pavement. The cover sheets must remain in place for seven days.

2-728 Temporary Crossovers

Prior to normal opening of the concrete pavement, it may be necessary to construct temporary crossovers at driveways or intersections. These crossovers must be constructed as shown on the standards that are a part of the pavement plans. A crossover bridge must be of sufficient height above the concrete so that it will not deflect against the concrete surface under maximum load. The crossing must bridge the lane completely from supports outside the concrete. Earth ramps are constructed so as to provide a smooth approach to and from the bridge.

2-729 Removing Forms

Forms must not be removed from freshly placed concrete until it has set for at least 12 hours. The workers who are assigned to remove the forms should be instructed in the proper manner to avoid spalling the edges of the concrete. Metal wedges, lever fulcrums, or stake-pulling devices are not permitted to have a bearing on the concrete when pulling forms or lifting pins. The Inspector must not allow the removed forms to be placed on the new concrete or the pins to be thrown carelessly about.

After the side forms are removed, the Inspector examines the ends of all joints to see that they are not bridged with grout. If they are bridged, they must be cleaned immediately. All honeycombed areas must be pointed up. Under no condition is the placement of shoulder material to be allowed until there is positive assurance that the joints are open. The workers must be instructed to replace the curing cover at the edges exposed by the removal of the forms.

2-730 Sawing Longitudinal Joints

Longitudinal joints must be constructed as shown in the plans and in conformance with the specifications, or as ordered by the Engineer. (Figure 2-7.8 shows a longitudinal joint.) The joints may be constructed by the following methods.

- If pavement is constructed a single lane at a time, the longitudinal joints between slabs must be of the tongue-and-groove type and constructed by means of the devices shown on the plans. The joints must be equipped with tie devices as shown on the plans.
- If multilane construction is used, the longitudinal joints may be formed by an approved nonmetallic joint forming insert introduced into the plastic concrete by mechanical equipment. The insert must be sufficiently rigid to remain in good alignment, and the size and shape must provide a joint of the specified configuration.
- If multilane construction is used, the longitudinal joint may be constructed with an approved concrete saw. It is the contractor's responsibility to perform the saw cutting operations at a time when excessive raveling or uncontrolled cracking does not occur. As sawing operations progress, the completed sawed joint must be thoroughly cleaned with air if dry cutting blades are used or with water if wet cutting blades are used until all dust or slurry is removed. Sawing must be performed within 4 to 24 hours of the placement of the concrete pavement.

In all cases, the longitudinal-joint groove must be constructed perpendicular to the pavement surface, true in alignment, and to the minimum depth and width specified or approved.

2-731 Sealing Joints

Before the pavement is opened to any traffic, public or contractor, all joints must be sealed as required. This is the last operation prior to opening the roadway to traffic. The sealing of the transverse and longitudinal joints prevents surface water from seeping through the joints and accumulating in the subgrade where frost action and other disintegrating effects may result.

The special provisions and plan notes should be reviewed to determine if the longitudinal joint is to be sealed. The current practice is not to seal the joint for single-lane construction.

Prior to pouring any filler, the joints must be swept clean, and any adhesions of dried grout particles must be chipped and removed or swept. The transverse joints must be cleaned for the full width of the expansion material, and the top of the expansion material must show over its entire area. The presence of any concrete in a transverse joint prevents free compression of the joint material and may cause spalling along the joint in hot weather. These joints and all others should be thoroughly cleaned of foreign material, including mortar, by scraping and blowing them out with compressed air. Watch for small stones that become lodged. They promote spalling of edges.

The joint seal material should be of the type specified. It should be mixed and heated in a suitable kettle, and a careful check should be made of the temperature as it is being heated. Particular care must be used in heating the material to avoid burning. The material usually is a rubber compound that is in a liquid or fluid state before heating. Heating activates the setting agents and the material changes state when it cools to become a resilient solid. Heating too long or at too high a temperature may damage the material. The material is usually applied under pressure with a mechanical applicator. The joint should be completely and neatly filled. Avoid placing excess material. The limits are flush to 1/8 in. (3 mm) below the surface. The Inspector must ensure that the workers engaged in this operation do not allow the joint seal to spatter or drip onto the adjacent pavement.

Prior to the final acceptance of the pavement or before the suspension of work for the winter months, the joints must be inspected and defective joints must be resealed.

2-732 Daily Reports and Tests

Paving Inspectors usually make out the standard Inspector's Daily Report, CON 134. Designated Paving Inspectors are required to make out a supplemental inspection report, CON 135, Concrete Pavement Daily Inspection Report, to record quantities, personnel, work limits, work hours, concrete mix information, and test results for materials. Figure 2-7.9 is an example of CON 135M. CON 134 is covered in Volume 1, Chapter 3, "Project Documentation."

During the course of each day's paving operations, quality-control determinations are necessary to ensure that such things as air content, slump, and structural strength are satisfactory. The duties are performed by the Inspectors assigned to the paving operation.

- The air content and slump should be checked periodically during the day, especially in the morning when the operation begins, and when the concrete changes.
- Eight cylinders should be cast for each concrete placement, four in the morning and four in the afternoon. Should the operations suspend early, every effort should be made to cast the necessary cylinders. They should be properly marked and placed out of the way of things so they will not be damaged.

Remember, these cylinders are used to determine the strength of the pavement, and a satisfactory compressive strength must be obtained before the pavement can be opened to traffic. Should they fail, the quality of the pavement will be questioned, and more tests will be required.

2-733 Air Content

The air content of freshly made concrete is determined with a pressure air meter. A Chace air indicator is used to check air content to determine if additional pressure air meter tests should be run. The pressure air meter is more sensitive and accurate than the Chace air indicator and therefore must be used for acceptance tests. Simultaneous tests with the pressure meter and air indicator should be made in the morning at the start of the day's operation and again at midday to correlate the instrument readings. Additional tests with the pressure meter are performed if cylinders are cast of which the air content as determined by the Chace indicator approaches the allowable air content limits of the mix.

Periodically during the course of the day's operation, check tests should be made with the Chace indicator. To fully document the information, the Inspector must record the percent of entrained air and the instrument used to determine it.

The Inspector responsible for the quality-control testing of concrete must read and thoroughly understand the manufacturer's operating instructions for the equipment used. The general operating procedure for each of the instruments is below

2-733A Pressure Air Meter

The generalized procedure is as follows:

- Select a proper sample of concrete.

Fill the measuring bowl in three equal layers.
- Rod each layer 25 times with an approved tamping rod.
- Tap the outside of the measuring bowl with an approved nonmetallic mallet after rodding each layer.
- Strike off the concrete flush with the top surface of the measuring bowl.
- Wipe the flange area of the measuring bowl.
- Place and secure the cover assembly.
- Open the fill valves and add water to the prescribed level.
- Set the meter's air gauge now at the zero calibration. The zero calibration for each meter is usually marked on the instrument. Depending on the type of instrument, the fill valves should be left open or shut while air is pumped into the meter to standardize the gauge. Tap the gauge lightly with the fingers and wait about 30 seconds. Add or bleed air, as required, to maintain the zero calibration reading.
- Depress the release valve.
- The gauge reading gives the air content.

2-733B Chace Air Indicator

The general procedure is:

- Fill the brass cup with cement mortar paste. Exclude particles larger than #10 sieve (2 mm). Rod the material in the cup with a knife or wire to compact the mortar and strike off the excess even with the top of the cup.
- Place a finger over the stem opening of the glass vial and fill the vial with alcohol.
- Insert the stopper in the vial, invert the vial, remove your finger, and adjust the alcohol level in the vial stem by manipulating the stopper. The level of the alcohol in the stem should coincide with the top stem marking.
- Place a finger over the stem opening. Roll the indicator from vertical to horizontal several times until all the mortar has been dissolved out of the cup. Keep the sand from entering the vial stem.
- Bring the indicator back to a vertical position. Remove your finger from the stem opening. Count the number of spaces from the top mark to the new liquid level.
- The number of spaces represents the air content in percent.

The Chace indicator reads direct for concrete mixes containing 15 cu. ft. (0.425 m³) of mortar. Readings obtained for mixes containing other than 15 cu. ft. (0.425 m³) of mortar are to be multiplied by a conversion constant to determine the actual air content.

The mortar content of the mix can be determined as follows.

- Get the specific gravity of the stone from the Laboratory.
- Multiply this specific gravity by 62.4 lbs./gal. (1,000 kg/m³).
- Divide the product into the total weight (mass) of stone in the mix. This gives the stone content in cubic feet (meters).
- Subtract this from 27 cu. ft. (1m³) (if you are using a 27 cu. ft. [1m³] mix), and the answer will be the cubic feet (meters) of mortar.
- Refer to the design-mix letter from Central Laboratory.
- For the mortar content per cu. yd. (m³), multiply the stem readings by the conversion factor below.

Figure 2-7.10 Mortar Content Conversion Factors

Mortar Content (m ³)	Conversion Factor	Mortar Content (m ³)	Conversion Factor	Mortar Content (m ³)	Conversion Factor
0.30	0.71	0.46	1.08	0.62	1.45
0.32	0.75	0.48	1.13	0.64	1.50
0.34	0.80	0.50	1.18	0.66	1.54
0.36	0.84	0.52	1.22	0.68	1.59
0.38	0.89	0.54	1.26	0.70	1.64
0.40	0.94	0.56	1.31	0.72	1.68
0.42	0.99	0.58	1.36	0.74	1.73
0.44	1.04	0.60	1.40	0.76	1.77

2-734 Pavement Cores

Prior to opening the pavement to traffic, the Chief Inspector makes arrangements to have cores taken to determine pavement thickness for payment purposes.

2-735 Opening the Pavement to Traffic

Under no condition can the roadway be opened to traffic until the compressive strength of the concrete has reached a minimum value of 3,500 psi (25 MPa). Eight cylinders must be cast daily by the Inspector to represent each day's run of concrete, and arrangements must be made with the Laboratory to have the cylinders broken at the intervals required.

Before opening a section of pavement as a temporary detour to the general public, shoulder material should be placed along the outer edge of the lane up to the pavement level for at least 18 in. (500 mm) in width to eliminate abrupt drop-offs at the pavement edge. If the ends or sides of the slabs at intersections must be protected from abrasion of traffic, suitable approaches must be provided to form a smooth, easy approach to the pavement and that, at the same time, adequately protect the edges of the concrete from undue stresses that might cause cracking or spalling.

Concrete lanes adjacent to the opened section must be protected by barricades to prevent vehicles from driving onto the closed lane. Do not permit the contractor to use one opened strip of concrete for two-way travel by batch trucks, unless the shoulder is built up to the grade of the concrete pavement and is of sufficient width to permit passage of trucks side by side. Otherwise, there will be travel over the unopened section or severe damage to the edge of the concrete. Before opening a section of roadway, except as a temporary detour, all construction and safety appurtenances must be completed. Work outside the shoulders or safety appurtenances may continue to completion after opening the roadway to traffic.

2-736 Full-Depth Concrete Pavement Replacement**2-736A Concrete Removal**

Before any existing concrete is removed, the Engineer inspects the concrete slabs where shown on the plans and designates any additional areas that require concrete removal. Full-depth repairs may be necessary because of the size of spalls, depth of deteriorated concrete or joint failure. Concrete removal is limited to the amount of concrete pavement that can be replaced during the working period.

2-736B Sawing

The existing pavement is sawed full depth along the boundaries designated by the Engineer. The sawing equipment must be capable of sawing neat vertical faces along the patch boundaries. Saw blades with toothed wheels are not permitted for sawing the patch boundaries. Saw cuts with a toothed-wheel saw blade are permitted inside the patch boundaries to facilitate concrete removal. If a toothed-wheel saw blade is used, a minimum 3 in. (75 mm) clearance must be maintained between the internal cuts and the boundaries of the patch.

It usually is necessary to saw into the adjacent slabs or shoulders to ensure that cuts are full depth in the corners. This "over-sawing" should be minimized. All over-sawed areas must be cleaned and filled with approved crack sealant.

Sawing may be performed in advance of the concrete removal operation. However, it is limited to a distance not to exceed the amount of patching that can be completed during the next five working periods. The distance is determined by the Engineer, based on past performance of the contractor.

2-736C Removal

The concrete can be lifted out with chains, lift-pins, or other approved devices. Breaking concrete in place is not permitted. During the removal operations, the contractor must be careful to minimize disturbance and damage to the subbase, adjacent pavement, or bituminous shoulder. Any areas damaged during either the concrete sawing or removal operation must be repaired to the satisfaction of the Engineer by extending the patch boundary at the sole expense of the contractor.

2-736D Existing Bituminous Patches

If existing bituminous concrete patches must be replaced with concrete, the pavement is cut full depth and removed. The adjacent concrete must be free of all bituminous material prior to placing the concrete. The edges of the existing concrete are inspected to ensure that neat vertical faces exist. The adjacent concrete edge must be repaired or recut if ordered by the Engineer.

2-736E Subbase

Disturbed or loose subbase is removed. The contractor is responsible for protecting the subbase and subgrade. The subbase is dampened prior to concrete placement, if ordered by the Engineer.

If the subbase or subgrade is too wet for concrete placement, the contractor is required to excavate and fill. Subbase replacement material must meet the requirements for graded aggregate subbase in accordance with Article M.02 of the *Standard Specifications*. Construction methods for the material must be in accordance with Article 2.12.03. The Engineer may require the contractor to install transverse subgrade drains in accordance with Article 7.51 of the *Standard Specifications*.

2-736F Load Transfer

Holes for load transfer devices must be drilled along the transverse joint at mid-slab depth, 12 in. (300 mm) center to center, as shown on the plans. Drills are mounted on a rigid frame to ensure proper horizontal and vertical alignment, and the holes are drilled to within a tolerance of $\pm 1/8$ in./ft. (± 10 mm/m). The drilling equipment and procedure must have the prior approval of the Engineer.

No. 10 (No. 30M) deformed steel bars are used in all fixed transverse joints. Load transfer bars 1¼ in. (32 mm) in diameter are used in all working transverse joints, as shown on the plans. All bars are 18 in. (460 mm) long and embedded 9 in. (230 mm) into the existing, adjacent slab.

Holes for deformed tie bars are drilled along the longitudinal joint between adjacent lanes at mid-slab depth as shown on the plans. Tie-bar spacing is 24 in. (600 mm) center to center or as shown on the plans. Tie bars are No. 5 (No. 16M) deformed steel bars for 9 in. or 10 in. (230 mm or 250 mm) concrete pavements and No. 4 (No. 10M) deformed steel bars for 8 in. (200 mm) concrete pavements. All tie bars are 30 in. (760 mm) long and embedded 15 in. (380 mm) into the slab of the adjacent lane. Tie bars must be installed as shown on the plans. If tie bars are not permitted, ¼ in. (6 mm) fiber board is used to break the bond between adjacent lanes.

The Engineer must inspect epoxy-coated bars to ensure that no damage has been sustained by the coating during shipment and handling.

Chemical anchor material is used to secure the load-transfer bars or tie bars in place. Chemical anchor material is placed using a flexible long-nose tube that injects the material in the back of the hole, in accordance with the manufacturer's recommendations. The injected chemical anchor material must be listed on the Approved Product List of the Department and approved by the Engineer for the specified use.

The bar is inserted in the hole with a slight twisting motion so that the material in the back of the hole is forced around the bar. A retention disk, made of polymeric material, is slipped tightly over the bar and against the slab face. The protruding ends of smooth load-transfer bars are lightly greased immediately in advance of concrete placement.

2-736G Forms

Forms are required on the bituminous shoulder side of the patch. To accommodate the side forms, the contractor must saw cut full depth and excavate 6 in. (150 mm) wide into the adjacent shoulder. Forms must extend along the existing shoulder pavement a minimum of 12 in. (300 mm) on either side of the patch and must be secured to prevent movement during concrete placement. After the removal of the form, the excavated portion of the shoulder is replaced with Bituminous Concrete Class 1 in accordance with Article M.04 of the *Standard Specifications* and must be true to the line and grade of the new patch and existing shoulder.

2-736H Reinforcement

Smooth welded-steel-wire fabric is used in full-depth patches. The reinforcement is placed at a depth of $3 \pm \frac{1}{2}$ in. (75 ± 13 mm) as measured from the top of the slab. A minimum clearance of $2\frac{1}{2}$ in. (60 mm) from the slab edges and dowel bars must be maintained.

2-736I Placement and Finishing

Concrete is placed in accordance with Article 4.01 of the *Standard Specifications*. Concrete placement is restricted to the late afternoon or evening during the summer months, or as directed by the Engineer. The limitation minimizes the effect of the daily expansion of adjacent slabs. The concrete mix is placed evenly to a level slightly above the adjacent pavement surface. The use of a continuous mobile mixer to facilitate patching operations, if using a proprietary rapid-setting concrete mixture, may be permitted with the approval of the Engineer.

2-736J Consolidation

Vibration must be used to thoroughly consolidate the concrete throughout the entire patch area. An approved spud-type vibrator or pan vibrator is used to consolidate the concrete. Vibrators must be capable of transmitting 10,000 to 15,000 vibrations per minute. Internal vibration must be used to consolidate the concrete beneath the reinforcing steel. Utmost care must be exercised to ensure that the concrete around the dowel bars and slab edges has been properly consolidated.

Vibrating plates or vibrating screeds must be used on the surface of all concrete pavement replacements for strike-off and consolidation. After the concrete is finished to a level slightly above the existing pavement surface, the vibrating plate or screed is drawn over the surface at a uniform speed, without stopping, to finish the surface smooth and even with the adjacent concrete. The type of screed or plate must be approved by the Engineer.

2-736K Strike-off and Finishing

The surface is struck off to finished grade with a steel or wooden template, and floated to a smooth finish. Addition of water to facilitate the finishing of the patch surface is not permitted. Finishing operations must be completed before initial set takes place. Patches less than 10 ft. (3 m) long (measured in direction of travel) are screeded parallel to the centerline. Patches greater than 10 ft. (3 m) long (measured in direction of travel) are screeded perpendicular to the centerline.

2-736L Surface Tolerances

The surface profile of the patch must not vary more than 1/8 in. (3 mm) in 10 ft. (3 m) when a 10 ft. (3 m) straightedge is placed on a surface at any angle. Sags or depressions in the surface of the patch area that exceed the tolerance are repaired at the expense of the contractor. High areas are ground down at the expense of the contractor by approved machinery as directed by the Engineer.

2-736M Joint Sealing

Joints are formed and sealed as shown on the plans. Joint sealing must be completed within five days after concrete placement. Joint sealant reservoirs are formed and filled with approved sealant. The reservoirs are thoroughly cleaned with water and dried with compressed air. An approved sealant is applied in accordance with Articles M.03.01-8a and 4.01.03-F.6 (f) of the *Standard Specifications* and as shown on the plans.

2-736N Curing

Concrete for pavement and high-early-strength Portland cement concrete are maintained with liquid curing compound as specified in Article 4.01.03-F.7 (a) of the *Standard Specifications*. In addition, an insulating curing blanket with a minimum thermal insulation value of R-3.5 must be placed over the patch if high early strength is required or if the ambient and existing concrete surface temperature is expected to drop below 50 °F (10 °C). Curing of rapid-setting concrete must be in accordance with the manufacturer's recommendations.

2-736O Testing

Any newly placed concrete patch having a hollow sound if chain dragged or sounded with a hammer must be replaced by the contractor in accordance with the contract documents.

The Inspector makes test cylinders in accordance with Article 4.01.03-I of the *Standard Specifications*. Additional cylinders are made to ensure the concrete has attained the required compressive strength prior to opening to traffic.

2-736P Opening to Traffic

Traffic will be allowed on areas of the roadway where the contractor has placed and finished full- depth concrete patches after the material meets the following criteria.

- Concrete for pavement must conform to Article 4.01.03-J of the *Standard Specifications*.
- High-early-strength Portland cement concrete and rapid-setting concrete must attain a minimum compressive strength of 1,800 psi (12,400 kPa).

Chapter 8 - Structures

2-801 New Construction

Bridge construction requires close cooperation between the contractor and Chief Inspector. A bridge design must meet the conditions unique to a specific site. It is especially important for the contractor to understand the desires of the Department in regard to the design as well as the finished product.

2-801A Storage/Staging of Materials and Equipment on Structures

The Federal Highway Administration issued an advisory to all State Highway Departments in the summer of 2007 asking for review of current practices for the stockpiling of materials and the staging of construction equipment on bridges under construction. The Office of Construction reviewed this advisory and in coordination with the offices of Design, Bridge Safety, Maintenance, and Federal Highway. As a result, the Load Restriction Specification, Article 1.07.05 was revised. It should appear as a special provision in all future projects until it can be incorporated into a Supplemental to the 816.

Designers are being directed to add notes to their structure plans to indicate the allowable load for existing structures and the proposed structure, if applicable. When a structure is not posted, the contractors will be allowed to stockpile material and store construction equipment, when the maximum weight of equipment or material stored in each 12 foot wide travel lane of any given span shall be limited to 750 pounds per linear foot combined with a 20,000 pound concentrated load located anywhere within the subject lane. **If these notes do not appear on the plan sheets, the Office of Bridge Safety shall be contacted immediately by the Project Engineer to determine the allowable load for the existing structure and the project's designer for the proposed structure.**

The operation of standard construction equipment for the rehabilitation and/or reconstruction of a structure do not fall under this guideline. The existing structure and proposed structure should have been reviewed for typical construction loadings. Any specific restriction will appear as a note on the plan. The Project Engineer should touch base with the designer after a thorough plan review to discuss loading restrictions, especially if:

- The structure has a pin and hanger assembly
- Load Restrictions are posted
- The bridge has been classified to have a specific structural problem awaiting repair
- The bridge is a steel arch truss structure

If anticipated storage of equipment or material exceeds the above provision, then the Contractor shall submit his proposal of storage, supported by calculations stamped by a Professional Engineer registered in the State of Connecticut, to the Engineer for approval 14 days prior to the storage operation. All submittals shall include a detailed description of the material/equipment to be stored, the quantity of storage if it is stockpiled materials, the storage location, gross weight with supporting calculations if applicable, anticipated duration of storage, and any environmental, safety, or traffic protection that may be required. The storage location on the structure shall be clearly defined in the field. If structures are in a state of staged construction or demolition, additional structural analysis may be required prior to authorization of storage. It is noted that operations associated with structural steel demolition and erection will follow their respective specifications.

2-801B Load Restrictions

All inspectors **should be aware** of load restrictions associated with the Department's roadway and bridge construction. In accordance with State Statute 14-269:

- This statute will apply to any four-wheeled motor vehicle equipped with pneumatic tires which is engaged in construction work or in supplying or transporting materials or equipment for public or private construction projects and which is operating upon a highway or bridge within twenty-five miles of such construction project
- No such motor vehicle may be operated upon any highway or bridge if its gross weight, including its load, exceeds forty thousand pounds.
- No such four-axle motor vehicle may be operated upon any highway or bridge if its gross weight, including its load, exceeds seventy-three thousand pounds.
- Any person who violates the provisions of subsection (b) or (d) of this section shall be subject to the penalties set forth in subsection (f) of section 14-267a.

Inspectors are cautioned that permitted equipment should not be moved or restaged without prior review with District staff to determine if any permit modifications are required on the part of the Contractor. This includes, but is not limited to, crossing an existing or newly constructed structure.

2-802 Chief Inspector's Duties

The Chief Inspector ensures that the bridge is constructed in accordance with the plans, contract documents and specifications. The work usually requires the assistance of others, such as survey parties, testing personnel, soils engineers, etc. The Inspector should request needed assistance through the Project Engineer.

Upon being assigned to a bridge project, the Inspector must make a careful study of the plans and become thoroughly familiar with the proposed work. All dimensions and elevations shown on the plans must be checked and verified for correctness and conformity. The Inspector checks the steel requirements of the plans against the approved shop drawings. The Inspector should also check the quantities for discrepancies.

Bridge plans should show all dimensions and details necessary to complete the construction or to enable the contractor to prepare necessary working drawings. In the case of Department-designed structures, shop drawings are submitted for approval by the various suppliers to the Department. In the case of consultant-designed structures, the Department sends the shop drawings to the consultant for approval. The approved plans are returned to the Inspector through the Project Engineer.

The Inspector reviews the contractor's proposed methods of construction for cofferdams, shoring, bracing and form work; and if, in the judgment of the Inspector, there is any doubt as to the adequacy of the proposed methods, the Inspector should immediately notify the Project Engineer.

The Inspector should understand the methods to be used by the contractor to construct the bridge and must be knowledgeable about the contractor's schedule of operations. Although the contractor must execute the work in accordance with the plans and to the lines and grades established by the Department, the Inspector must check and be thoroughly familiar with all aspects of the construction to guard against possible errors and omissions.

The Inspector checks any work that is ready for inspection as well as any operations in progress that affect the quality of the work. The Inspector should immediately point out to the contractor's representative any errors detected so that they may be corrected without delay. If the Inspector encounters an aspect of the proposed construction on the plans or in the contract documents that may not satisfactorily accommodate actual field conditions, the matter should be promptly discussed with the Project Engineer.

The Inspector is responsible for determining all quantities for payment. The Inspector makes or arranges to make all field measurements necessary for the accurate computation of the quantities.

2-803 Changes

The contractor may request changes in the plans or contract provisions regarding construction methods, materials, or procedures. Requests are made by the contractor (not by a subcontractor) to the Assistant District Engineer who requests a final review by Design, if deemed necessary. Typically, Design sends its comments directly to the Assistant District Engineer, with a copy of the comments to the Manager of Construction Operations.

2-804 Shop Drawings

Before fabricating any material, the contractor must submit shop drawings to the Engineer for approval. The drawings must include erection plans, material lists, and material designated for project use, such as:

- reinforcing steel
- anchorage details for rail attachments at the ends of bridge parapets
- structural steel
- pretensioned concrete beams and deck units
- post-tensioned concrete superstructures
- post-tensioned pier caps
- concrete for structures (including remain-in-place forms, if applicable)
- “modular” expansion joints
- mechanical/electrical components of movable bridges
- elastomeric compression seals
- bearings
- bridge scuppers
- pipe for bridge drainage
- stain protection
- metal bridge rail
- open steel sidewalk grating
- granite facing
- illumination

In addition to bridge items, shop drawings are required for precast retaining walls, side-mounted sign supports, bridge-mounted sign supports, and tubular and truss sign supports.

The drawings are submitted to the designer, except for side-mounted sign-support drawings. They are submitted to the Office of Traffic Engineering. Regardless, a copy of the letter of transmittal is sent to the District. The Inspector should maintain a shop drawing log to track approvals and notify the Project Engineer if approvals are not timely.

2-805 Manufacturer's Supervision

The *Specifications* for a number of bridge structure items require a representative or technical adviser of the manufacturer to be present at the installation to give the aid and instruction needed to obtain satisfactory results.

The following list indicates the items that currently require a manufacturer's representative to be present at the time of installation:

- Portland Cement Concrete-Joint Seals for Structures – Type “A” Joint Seal only
- Class Concrete (Post Tensioned Superstructure) – Epoxy Bonding Compound
- Epoxy Coal – Tar Delineation for Bridges
- Elastomeric Expansion Device
- Modular Expansion Joint
- Post-Tensioning of Superstructure
- Post-Tensioning Pier Cap
- Epoxy Bonding Compound – Chemical Anchors
- Amine – Epoxy Surface Coating
- Amine – Epoxy Skin Patch
- Amine – Epoxy Finishing Patch
- Remove Concrete Nosing and Curb
- Membrane Waterproofing
- Pot or Disc Bearings
- Epoxy Injection Crack Repair
- Some types of Precast Retaining Walls
- Some field-applied bridge coatings

Because this list will change, the specifications of the individual projects should be reviewed to determine what other items may require a representative of the manufacturer to be present at the time of the construction.

2-806 Cofferdams and Underwater Concrete

Cofferdams are covered in Article 2.04 of the *Standard Specifications*. They must be constructed to protect uncured concrete and masonry from water damage and foundations from erosion.

If cofferdams are required, the contractor must submit drawings prepared and sealed by an engineer licensed in Connecticut, along with a complete description of the process for construction of the cofferdam. The drawings and description are reviewed, and comments are offered by the Department. The furnishing of the plans and methods does not relieve the contractor of any responsibility for the safety of the work or for the successful completion of the project.

2-807 Foundation Seals

If the foundation cannot be dewatered, the Engineer may require the construction of a concrete foundation seal. A sketch is shown in Figure 2-8.1. Tremie concrete is normally used. The contractor must submit drawings and a detailed description of the process for review and approval before placing the seal. If a mud wave is created during the placement of the tremie seal, the displaced material is removed to preserve the full foundation cross section specified in the contract documents.

After the seal has been placed, the foundation is pumped out, and the footing is placed in the dry. If weighted cribs are employed and the crib weight is used to overcome a part of the hydrostatic pressure acting against the bottom of the foundation seal, special anchorage such as dowels or keys are provided to transfer the entire weight of the crib, into the tremie concrete. If a tremie concrete seal is placed, the cofferdam must be vented or ported at the low-water level as directed.

Figure 2-8.1 Foundation Seal

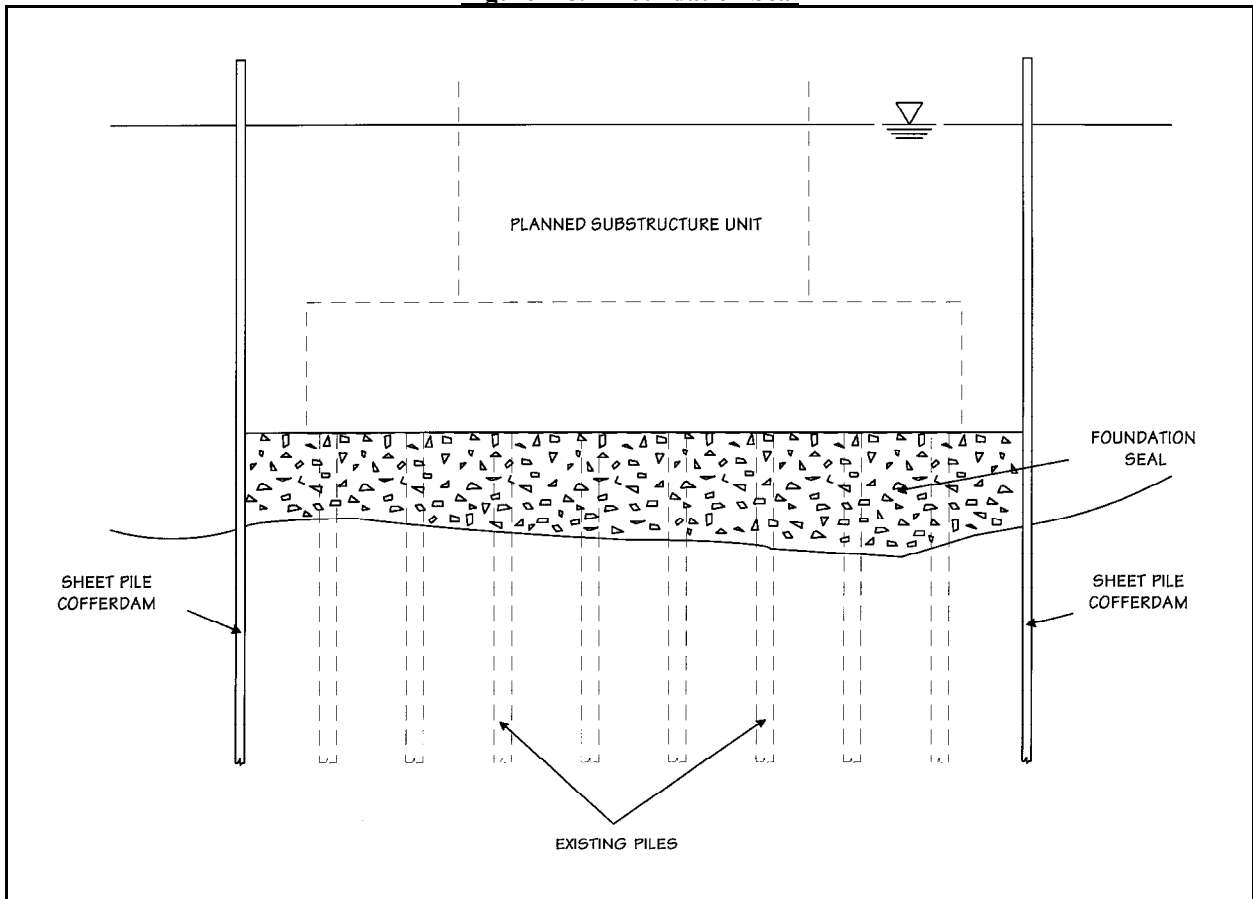

2-808 Pumping

During the placement of concrete or masonry and for 24 hours after placement, pumping must be done from a sump located outside the horizontal limits and below the elevation of the work being placed. Pumping to dewater a sealed cofferdam must not begin until the seal has set sufficiently to withstand the hydrostatic pressure.

Refer to Sections 2-111A and 2-111B for information pertaining to environmental considerations for handling water and dewatering of cofferdams.

2-809 Removal of Cofferdams or Cribs

Cofferdams or cribs are removed by the contractor after the completion of the substructure and without damage to the substructure. No part of the cofferdams or cribs that extend into the substructure may be left in place without written permission from the Engineer. Any damage to the substructure will be repaired by and paid for by the contractor.

2-810 Stability of Foundation

The contractor is responsible for stabilizing the foundation area such that the concrete footing can be constructed in the dry and in its proper location.

2-811 Excavation

Structure excavation definitions are found in Article 2.03 of the *Standard Specifications*. The Inspector must be familiar with Article 1.07.07 and the latest edition of OSHA Publication 2207.

Cofferdams and pumping necessary for the completion of the work must be properly located and be constructed with adequate interior horizontal dimensions and structural adequacy to properly perform all required work incidental to the construction.

The elevation of the bottom of a footing, as shown on the plans, may be varied by the Engineer to secure a satisfactory foundation. If rock is encountered, accurate cross sections must be taken before any cofferdams are installed or excavation work is performed, and after the excavation work has been satisfactorily completed.

If foundation piles are not used and excavation to suitable bearing must be made below the planned bottom of the foundation, the additional excavated spaces under the substructure units are to be filled with concrete, the footing elevation lowered, or the footing deepened as specified in the contract documents or as directed by the Engineer. Rock foundations that are to receive footing concrete must have a rough finish. If excavation to suitable bearing for box culverts must be made below the planned bottom of the foundation, additional excavated spaces under the barrels are backfilled with select backfill. The spaces under the wing-wall footings are filled by lowering the footing elevation or deepening the footing.

Structure excavation for footings may be increased by not more than 2 ft. (600 mm) and remain within the scope of the excavation item. Quantity changes resulting from dimension variations exceeding 2 ft. (600 mm) are to be paid for in accordance with the *Standard Specifications*. Permission to increase the size of the footing must be requested from the Engineer.

2-812 Tying New Concrete to Existing Concrete

If portions of an existing structure are used in the new structure, the new structure is tied to the existing one. If existing concrete is removed, the existing reinforcement steel to be incorporated in the final structure should be straightened and cleaned. The contractor is required to submit a straightening procedure in writing for approval. Care must be taken not to damage the bars. All existing reinforcing steel extending into an area of epoxy-coated reinforcing steel must be sandblast-cleaned and epoxy-coated.

If the existing, exposed reinforcement has lost 20 percent or more of its original cross-sectional area, it must be replaced. A new bar of the same diameter is provided and placed so as to have the minimum required lap at each end of the new bar. If the required bar lap is available, the deficient bar is used as a dowel. If the required bar lap is not available (or too much concrete would need to be removed to obtain the required lap), a welded or approved mechanical splice is used.

If dowel bars are required to tie new concrete into an existing structure, the dowel holes will be at least the diameter of the dowel bar plus ½ in. (13 mm). Dowel-bar hole sizes are different for epoxy-grouted bars

than for cementitious-grouted bars. The Inspector should be aware of the manufacturer's requirements and recommendations. Depth of embedment is as shown on the plans.

2-813 Foundations

The design of a structure foundation involves various dead loads, live loads, site limitations and restrictions, the relationship of the structure to the adjacent roadways, roadway geometry (both over and under the structure), stream flow and alignment, and the type and support capacity of the soils. The Engineer must be notified immediately if there are questions as to the ability of the underlying material to support the structure or if the existing conditions differ from those shown on the borings or on the plans.

The elevation of the bottom of the footing specified in the contract documents can be considered an approximation. During construction, any changes in dimensions or elevations of footings to secure a satisfactory foundation must be reviewed and approved by the design engineer.

Prior to the completion of excavation for a bridge footing, box culvert, or structural plate pipe, the Inspector will notify the Project Engineer so that the Project Engineer or a designated assistant may examine the foundation before any concrete is placed. Footings for structures must be constructed on suitable foundations, and no concrete may be placed or foundation piles driven until the foundations are approved by the Engineer.

There are three common types of foundations:

- spread footings
- foundations seated in rock
- pile-supported foundations

2-813A Spread Footings

Spread footings usually are used if the bearing capacity of the soil at the site is adequate to support the structure. Generally, spread footings are the most economical type of foundation. Granular fill is usually needed to provide for uniform load transfer from the footing to the existing ground and/or to establish a level bearing area. The granular fill must be carefully placed and thoroughly compacted in layers on a shaped and graded foundation area, as shown on the plans.

To provide for uniform load transfer from the structure, through the footing, to the existing ground, the structure should be constructed on undisturbed soil. Faces of footings are placed plumb against undisturbed material, rock, sheeting, shoring, or forms. If the excavation does not stand plumb, the contractor must furnish and install sheeting, shoring, or forms as required. OSHA requirements for support of embankments in excavations must be met. If specified in the contract documents, sheeting used to construct spread footings must be left in place and cut off below finished grade to the depth shown in the plans. If not specified, the sheeting may be removed.

The design of sheeting and shoring is the responsibility of the contractor. If the material retained by the sheeting and shoring is greater than 6 ft. (1.8 m) high, the detail, procedure, and computations must be submitted to the Department for approval. The submittal must be sealed by an engineer, licensed in Connecticut and experienced in this type of work.

Forms used for footings must be removed, and any void between the footing and the embankment must be backfilled with suitable material. The material is compacted to not less than 95 percent of its maximum density. Foundation concrete must be used for this backfill if footings are submerged. Working drawings for forms used for footings are not required.

In certain instances, subsurface soils require preconsolidation using a superimposed load, or surcharge. If a superimposed load is to be installed over a granular fill in place, the granular fill should be placed about 6 in. (150 mm) higher than the proposed elevation of the footing. The additional depth of material provides for a settlement allowance and facilitates the placement of the footing on a firm, uncontaminated granular base (after removal of the surcharge and any excess granular fill).

2-813B Foundations Seated in Rock

Foundations for structures in rock-cut locations are usually supported by a modified concrete spread footing that is constructed on rock. Special care must be taken in excavating the rock to the limit prescribed on the plans to avoid excessive fracturing of the rock that reduces its bearing capacity. This could result in a reduction of the stability of the structure.

Rock or other hard foundation material is cleaned of loose material and cut to a firm surface, either level or stepped, as directed by the Engineer. All seams or crevices are cleaned out and grouted. All loose and disintegrated rock and thin strata are removed.

The Inspector must maintain a record of the elevations of the bottoms of all drill holes and a sketch of their locations if ledge rock is removed to reach foundation grade. The data become part of the project records. The contractor should be cautioned that payment for structure excavation rock will not be made for depths greater than 6 in. (150 mm) below the plan grade or approved revised plan grade. Refer to Article 2.03 of the *Standard Specifications*.

2-813C Pile Supported Foundations

If the existing soils cannot satisfactorily support a structure, foundation support is provided by piles or caissons. The piles may be end bearing or friction type:

- End-bearing piles usually are steel pipe piles or steel H-piles that are driven to refusal with an approved hammer. Prior to driving end-bearing piles, soil borings are studied, and the soil types above the rock are evaluated for elevation and driving resistance. Hard pan, till or decomposed rock often overlie satisfactory rock. High pile-driving resistance [high blows per foot (meter)] should not be mistaken for refusal.
- Friction piles may be steel H- or pipe piles, or precast or cast-in-place concrete piles. Friction piles often are driven to a prescribed tip elevation or blow-count resistance. The criteria are based upon soil testing, test-pile driving resistance results, and pile-load test results.

Figure 2-8.2 Piles

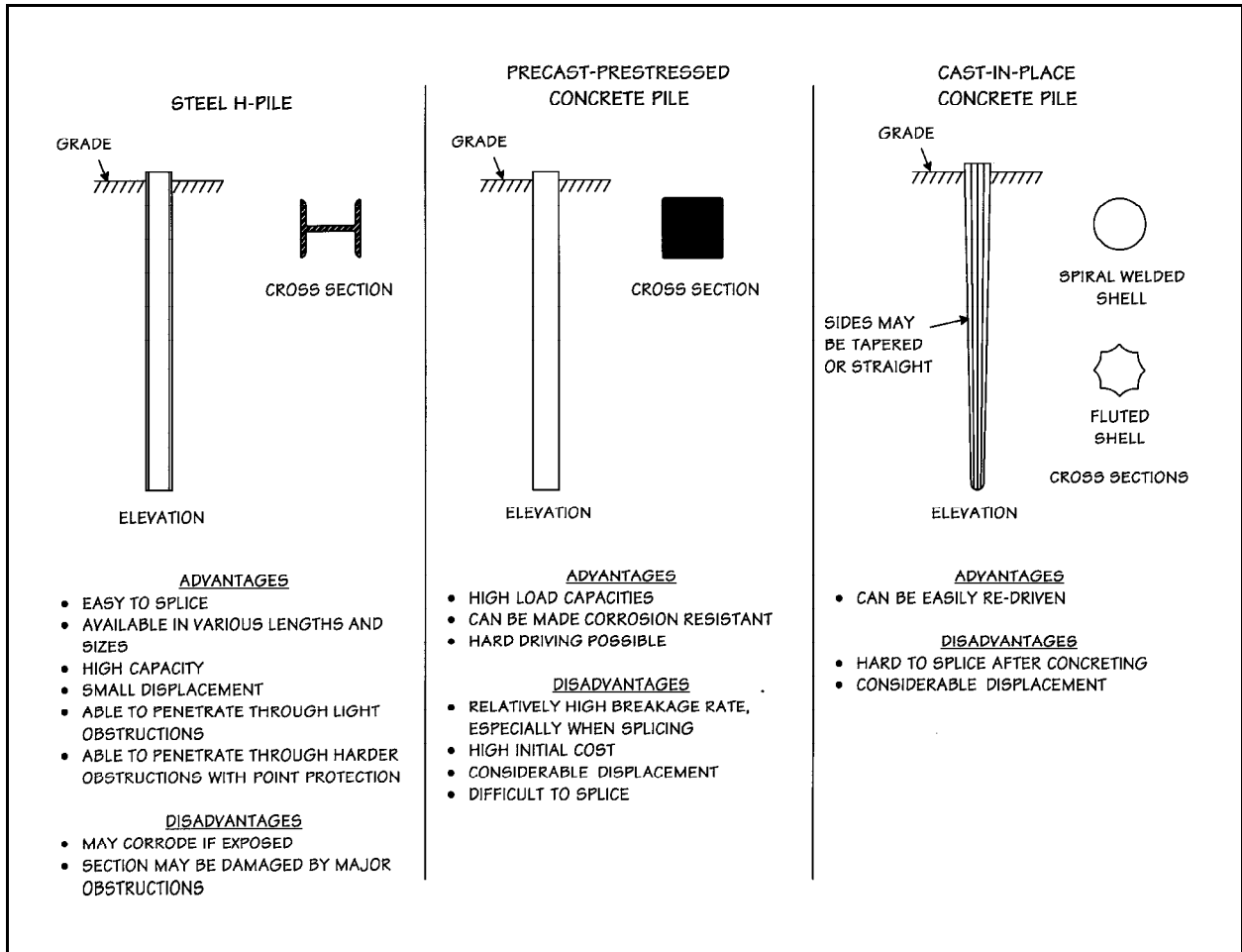

H-, precast, and cast-in-place piles are shown in Figure 2-8.2.

The type of pile specified must be driven in accordance with the current *Standard Specifications* and based upon the specific recommendations of the Soils and Foundations Division. The Inspector must notify the Project Engineer of the date set for driving test piles sufficiently in advance of the actual operation to arrange to have the Soils and Foundations Engineer or designer present. Test piles are driven with the same equipment and by the same methods to be used for the piles of the permanent structure, because appreciable differences in hammer types, weights, and drop result in differences in penetration and bearing.

The depth of penetration and the length of piling for structures are usually determined by driving test piles. The contract documents specify the test-pile locations, minimum penetrations and bearing values, and estimated tip elevations. The contractor uses the information to order and drive the test piling. Then the actual, safe bearing value of the test piling is determined by load testing.

Some project's Special Provisions call for the contractor to hold off on ordering the pile lengths for the job until after data from driving the test pile has been analyzed.

2-813C.1 Load Test

Load tests are covered in Article 7.02.03-10 of the *Standard Specifications*, “Determination of Bearing Values of Piles.” The load-test setup, the measuring system, the loading device, the loading procedure, the frequency of measuring the movement of piles, and the recordkeeping must conform to the contract documents.

The contractor must submit drawings and computations to the Engineer showing all details of the proposed pile load-test setup and must obtain the Engineer's approval prior to starting the work. The submittal includes the method of applying the load, the reaction frame and reaction pile configuration, if used, and the placement and support of measuring devices.

At each load test location, the Engineer provides driving criteria for the test pile. The pile is driven and load tested to the test load specified in the contract documents or as directed by the Engineer. If the pile fails to achieve the required capacity, a contingent load test is performed on a second test pile. This pile may be located adjacent to the initial test pile and driven according to revised driving criteria provided by the Engineer. The Engineer may elect to have the contractor redrive piles that do not meet the required penetration resistance.

If, at any stage during the test, the Engineer detects malfunctioning of any apparatus furnished by the contractor, the load being eccentrically applied, or the anchor piles yielding, the Engineer will order the test abandoned, and the contractor will replace it with another test at no additional cost to the State. The contractor must have an employee present at the site at all times during the performance of the test to maintain the required load.

After the test piles are driven, and the pile load tests, if any, are performed, the Soils and Foundations Engineer or consultant designer will promptly analyze the data and furnish the Assistant District Engineer with a list of recommended order lengths for the piles in that locality. If these lengths appear proper, the Project Engineer will use them to make up an order list to the contractor for pile lengths to be furnished by the contractor. The Department is responsible for determining required pile length.

2-813C.2 Driving Plan

The contractor must submit a plan of the pile-driving method to the Engineer, including type of hammer, for approval prior to driving any piling.

2-813C.3 Equipment

The size of the hammer must be appropriate for the type and size of the piles and the driving conditions. The hammer to be used must be approved by the Soils and Foundations Engineer. The Inspector should refer to Article 7.02.03-5 of the *Standard Specifications*.

The hammer to be used for driving permanent piles must be the same hammer that was used to drive the test piles. If the contractor changes hammers, the contractor must drive additional test piles at his expense before driving the permanent piles, even if the energy ratings of the hammers are identical.

Hammers are to be operated at speeds recommended by the manufacturer for the bearing value specified. The manufacturer's manual for the hammer employed must be available to the Engineer at the project site.

If the required penetration is not obtained by the use of a hammer complying with the requirements, a heavier hammer, jetting, spudding, or a combination of these methods may be used to obtain the required

penetration. The Inspector must be aware that hammers delivering an energy that the Engineer considers detrimental to the piles will not be used. Diesel hammers and vibratory methods for driving piles, other than prestressed concrete piles, are permitted subject to the restrictions in the applicable *Standard Specifications*.

Pile-driver leads are used for driving all piles unless otherwise permitted by the Engineer. The contractor must drive the piles within the tolerance as specified without injury to the piles. Any leads that do not produce satisfactory end results in the driving of piling are to be removed from the work.

Long piles and battered piles may require guides and additional support to prevent excessive bending or buckling under the hammer blow. Piles must be held in place and aligned by templates or other means approved by the Engineer.

2-813C.4 Driving

In pile-driving operations, the Inspector must be aware of a number of circumstances that may cause driving resistance to be falsely indicated.

- If using a pile hammer that is too light, a considerable amount of the energy is absorbed by inertia of the pile instead of being available for driving.
- The stroke of the hammer may be shorter than needed and should always be checked.
- Slowing down some types of single-acting hammers by the operator will reduce the stroke by several inches (millimeters).
- Resetting the slide bar on a hammer will create back pressure and will ultimately reduce the penetration of the pile under each blow.
- Soft wood placed in the cushion pad will absorb energy, falsely indicating resistance.
- Reduction of speed in a double-acting hammer will reduce the energy of the hammer.

If piling must penetrate strata that resist driving, the contractor must auger or drill holes through the strata. The size of the auger or drill may not be larger than the nominal diameter of a round pile or the minimum diameter of a circle in which an H-pile fits and must meet with the approval of the Engineer before use. After the hole is completed, the pile is inserted and dry sand is used to completely fill any voids between the pile and the walls of the hole. Driving is then completed, after which any remaining voids are completely filled with dry sand.

Once driving a pile has begun, it must be kept continuous except for splicing. A temporary halt in driving a pile may allow the pile to “set”. It may be necessary to continue driving the halted pile for a distance of several feet (meters) before resistance returns to what it was before the stoppage.

If splicing is necessary, it should be performed before approaching the estimated tip elevation. If splicing steel H-piles or shells for cast-in-place concrete piles is necessary, the piles or shells must be spliced as specified in the contract documents by electric arc welding conforming to the American Welding Society (AWS) Structural Welding Code for the full periphery. The number of splices permitted should be compatible with driving conditions at the site and the standard lengths of piling produced by manufacturer.

A pile may become overstressed during driving. If a pile is founded on rock, it becomes a column and additional driving cannot increase its bearing value, but it may seriously damage the pile by brooming, fracturing, or shearing. When the resistance to driving is increased to near the design resistance, smaller increments should be used to check penetration. They will aid the Inspector in ascertaining the number of blows required for each foot (meter) of penetration, the total driving length, and the elevation of the tip of the pile.

Disposition of pile cutoffs is covered by Article 7.02.03-14 of the Standard Specifications or by the project special provisions.

2-813C.5 Tolerances

Piles are driven to the following tolerances:

- *General.* Foundation piles should not be driven out of the position specified in the contract documents by more than 6 in. (150 mm) in any direction regardless of the length of piles. Variation from the vertical or from the batter should not be more than ¼ in./ft.(20 mm/m).
- *H-Piles.* Rotation of the pile in excess of 25 degrees from the planned axis is not permitted.
- *Bents.* Piles must be driven so that the cap may be placed in its proper location.

2-813C.6 Unacceptable Piles

Any pile that does not conform to the contract documents is corrected at the contractor's expense by one of the following methods or by other methods approved by the Engineer:

- The pile is withdrawn and replaced by a new pile.
- A second pile is driven adjacent to the unacceptable pile.
- The pile is spliced or built up.
- A sufficient portion of the footing is extended to properly embed the pile.

2-813C.7 Reporting

An accurate and complete record should be kept of each driven pile for substantiating the length driven, driving resistance, and tip elevation. The records are kept on Form CON 87 which can be found in the Approved Forms folder.

2-814 Formwork

The contractor is responsible for assuring that forms are adequate. If there is reason to believe that the formwork is inadequate to support pressures from plastic concrete, the Inspector should consult with the Project Engineer and immediately notify the contractor of the concern.

Forms must be fabricated and erected to accurate measurements and lines, and with tight joints, by experienced and capable carpenters, and they must be thoroughly finished and braced. Used lumber must be cleaned before it is reused. Plywood must be free of broken edges and other damage that affect the exposed surface. All defects, including penetrations, ply delaminations, and holes, are plugged and finished flush with the surfaces of the forms. All forms are oiled with clear form oil before use.

Sufficient ties and spreaders should be provided to properly align the forms. Sufficient bracing must be provided to hold the forms in their proper positions while the concrete is being placed. Metal ties and anchors used to hold the forms in alignment and location must be constructed so that the metal can be removed to a depth of at least 1 in. (25 mm) from the surface of the concrete without damage to the concrete.

All cavities should be filled with an approved mortar or non-shrink grout. Spreaders are removed when the concrete reaches their level.

The contractor establishes string lines or other suitable means for checking the alignment of the forms during and after concrete is placed. The Inspector must check for alignment and grade before, during, and after the placement of the concrete. The Inspector personally checks established string lines and requires the contractor to assign a competent foreman to check and adjust the alignment of the forms during the concreting operations. The Inspector must closely observe all corners and walers to ensure that any movement during the placement of concrete is brought to the contractor's attention. The contractor must realign and strengthen the forms or halt the placement of concrete until the possibility of form movement or failure is eliminated.

2-815 Reinforcement

Reinforcement is covered in Article 6.02 of the *Standard Specifications*.

2-815A Plan Dimensions

All plan dimensions related to reinforcing steel are out-to-out measurements. Spacing is measured center to center.

2-815B Cutting and Bending

Reinforcement bars are cut and bent at the mill or shop to the shapes specified in the contract documents before shipment to the job site. Reinforcement bars must not be bent in the field except to correct errors, damage by handling and shipping, or minor omissions in shop bending.

2-815C Storage

Bundles of reinforcing bars are stored at the site on suitable blocking or platforms sufficiently high to keep them free from vegetation growth, accumulations of dirt, oil, or other foreign material. Blocking must be sufficiently close to avoid bending and distortion of the bars. Any distortion of the bars or damage to epoxy coating must be corrected as directed by the Engineer at the expense of the contractor.

Rebar can only be stored on the existing bridge if its weight has been reviewed as noted in Section 2-801A.

2-815D Installation

Longitudinal and transverse bars must be properly located relative to each other. An adequate number of approved metal chairs or suitable precast mortar blocks are used to support reinforcement at the proper elevations. However, reinforcing bars must not be supported by chairs, stand-offs, blocks or other methods against formed surfaces that will be exposed in the completed structure. In addition, no bars are to be cut and spliced for reasons of expediting the installation unless otherwise permitted. All splice lap lengths must be the proper length and in the proper location.

The Inspector must check that the required quantity of reinforcing steel is properly installed and that it is securely fastened so that it remains in position during the placement and consolidation of the concrete. The reinforcing bars must not become displaced or untied during concrete placement operations.

If metal chairs are used to support the reinforcement, there is a tendency for the chair legs to be exposed when the forms are stripped. A part of the chair may protrude beyond the surface of the concrete, where it

is susceptible to corrosion. This can be eliminated by using precast mortar blocks to space the steel from the form, as shown in Figure 2-8.3. However, when this method is used, the concrete must be carefully vibrated to avoid honeycombing or the formation of voids around the mortar blocks. The Inspector must not allow the use of wooden blocks for the support of reinforcing steel.

Figure 2-8.3 Mortar Block

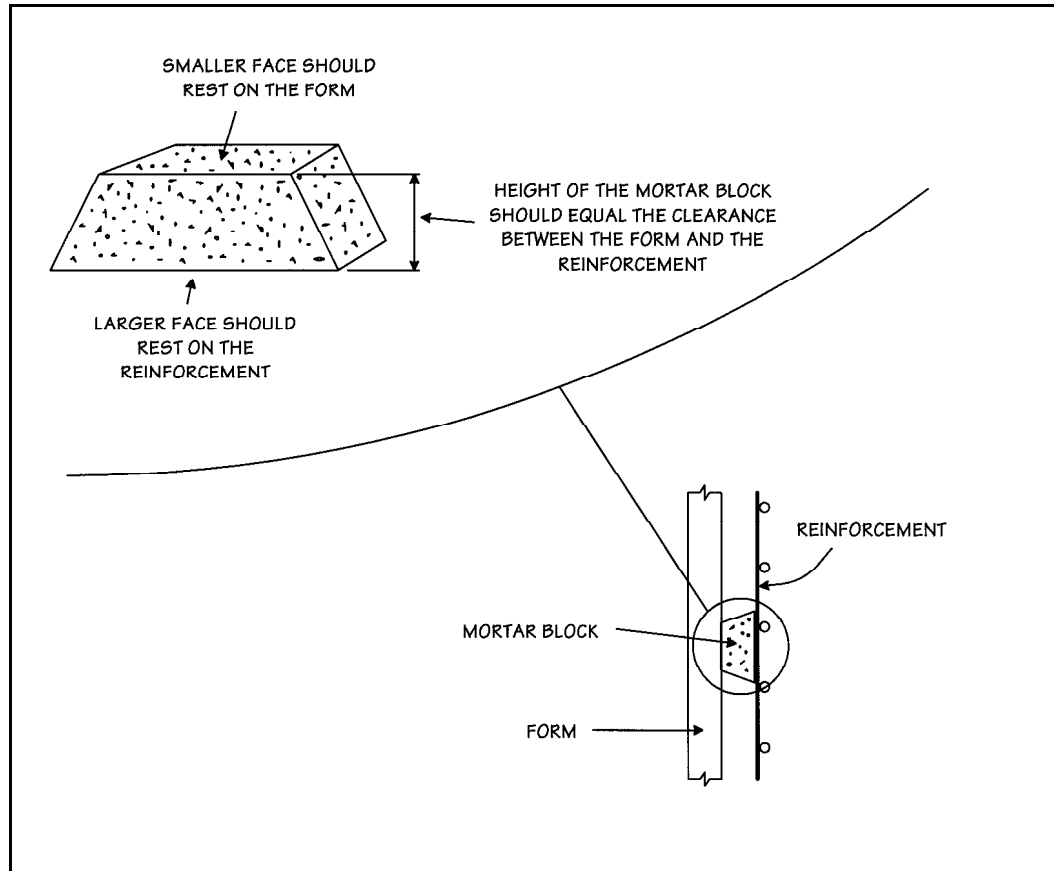

2-815E Splicing

In lapped splices, reinforcement bars are placed in contact and wired together. Bars in beams, girders, walls, columns, footings, slabs, and haunches are lapped 24 diameters. Bars in the upper section of beams and girders are lapped 35 diameters if there is more than 12 in. (300 mm) of concrete under the bars. Mechanical and welded splices are allowed if in the plans or authorized in writing by the Project Engineer. Refer to Section 10 of the AASHTO *Standard Specifications for Highway Bridges*.

Dowel-bar splicing systems may be designated for stage construction, as indicated on the plans. The contractor may elect to use these in certain situations; the required approval is made by the Engineer.

2-815F Epoxy Coating for Bars

The Inspector must be familiar with the special provisions for the epoxy coating for reinforcement bars and the touch-up for repair furnished by the manufacturer. Flame cutting of coated bars is not permitted.

A final visual inspection of epoxy-coated steel at the construction site should be made by the Inspector after the steel is in place, immediately prior to placing the concrete. Areas designated by the Inspector that require repair should be patched with epoxy. No concrete may be placed on a patched area until the patching material has cured for one hour. The contractor must allow the Inspector sufficient time after the reinforcement and forms are in place to conduct the inspection.

2-816 Concrete

2-816A Concrete Mix

The Inspector must become thoroughly familiar with Article 6.01 of the *Standard Specifications*. This Article contains the requirements for mixing, transporting, placing, and curing concrete. All sources of supply are approved by the Central Laboratory annually and are available on request from the District. Mix design information and approved vendors can also be accessed from the SiteManager Terminal Server files.

One of the first duties of the Inspector is to obtain an approved concrete-mix formula from the Central Laboratory for the anticipated suppliers of concrete. The Laboratory tests and approves the operation of each concrete plant and the materials. They also design the standard concrete mixes. The contractor may use the standard concrete mixes or submit a nonstandard mix design. If the contractor submits a non-standard design, the Inspector assures that it is forwarded to the Laboratory with sufficient lead time to allow for approval prior to placing concrete.

Requests for material tests for fine and coarse aggregate must be submitted by the Inspector to the District Laboratory in accordance with the frequency for acceptance and requirements identified in the current ConnDOT "Schedule of Minimum Requirements for Sampling Materials for Test." The concrete tickets must be signed by the Inspector.

2-816B Sampling and Quality Control

2-816B.1 Sampling

The following procedures should be used for sampling concrete:

- *Truck Mixer*: The samples, including slump, air entrainment, cylinders, etc., are taken at three or more regular intervals during continuous concrete placement. The Inspector can increase the frequency if a change in the mix is apparent. The samples must not be taken at the very beginning or very end of the distribution. The same procedure is used for trucks delivering central-mix concrete. For truck-mixed concrete, the mixer capacity, the number of revolutions at mixing speed, and other checks are recorded on each load ticket at the time a test specimen is made.
 - Any one of the following should be sufficient cause for rejection:
 - the mixing revolutions exceed 100
 - the concrete is not discharged within 1 hour from the time the truck is loaded
 - the air content or slump is not within specified range
 - there is segregation (see Article 6.01.03 of the *Specifications*)

- *Stationary Mixer.* The concrete sample should be taken after approximately one-half of the batch is discharged. If a chute arrangement is used, samples may be taken by diverting the concrete discharge stream completely until a sufficient amount of material is acquired. If the concrete is discharged directly into a concrete bucket, the discharge should be stopped after approximately one-half of the material is discharged, and the required amount of concrete removed from the top of the bucket. The sample should be put in a wheelbarrow. A hand bucket can be used if a wheelbarrow is not available.

2-816B.2 Testing

After sampling, whether from trucks or stationary mixers, the concrete is moved to a safe area where the necessary tests can be completed. At the site where tests and specimens are to be made, the Inspector remixes the concrete with a shovel to ensure uniformity. If buckets are used, the material is dumped on a flat, level surface, such as a piece of plywood, and remixed. After remixing, the concrete is covered to prevent loss of moisture.

The first tests to be made are the slump test and the air entrainment test. If either the slump or air test does not meet Department requirements, the load should be rejected or adjusted. The concrete plant and the inspector at the plant must be notified of the action. If the tests are satisfactory, specimens should be made.

Test cylinders should be molded by placing the fresh concrete in the standard mold in three layers, each approximately one-third of the volume of the mold. Each layer is rodded with twenty-five strokes of the rod. The strokes are distributed in a uniform manner over the cross section of the mold and should penetrate into the underlying layer by 1 in. (25 mm). The bottom layer is rodded throughout its depth. After the top layer is rodded, the surface of the concrete should be finished to a true plane. Care must be taken in moving and transporting cylinders after their initial set.

After curing for twenty-four hours, the specimen is removed from the mold and properly cured. Curing methods and locations should duplicate those of the actual structure. Care should be exercised during curing to make sure specimens are not damaged. Arrangements must be made by the Inspector to have Laboratory personnel test the specimens.

If slump and air are satisfactory and specimens have been molded, the information obtained is reported on the cylinder card MAT-29, using SiteManager or the paper form for non-SiteManager projects. The Inspectors make a minimum of three cylinders for each unit placed. The cylinders should be numbered "1, 1a, 1b;" "2, 2a, 2b;" etc. The location represented by each sample should be clearly noted.

Concrete slump and air tests are made periodically throughout the placement to ensure proper mix consistency. The procedures for making slump tests and air tests are described in Sections 2-723C and 2-733A within Volume 2, Chapter 7, "Concrete Pavements."

The AASHTO and ASTM methods for air entrainment determination, slump testing and molding of test specimens all require a round, straight steel rod, about 5/8 in. (16 mm) in diameter and approximately 24 in. (610 mm) in length, with one end rounded to a hemispherical tip. Unless the operator exercises care, a great deal of damage can be done to the air meter, base plates, or the cylinder forms by this steel rod.

2-816C Placement

Concrete can be structurally unsound if not correctly placed, consolidated and cured, even if the right materials and mixing methods are used. The Inspector must assure that placement is in strict compliance with Article 6.01.03-8 of the *Specifications*.

All foreign material, such as wood chips, paper, wire, dirt, water, mud, etc., must be removed from the forms before the start of a concrete operation.

Concrete should be deposited as close as practicable to its final position. Concrete segregates if it is allowed to run or fall freely or is worked over a long distance. If concrete must be moved a long distance, use concrete hoppers and trucks. Over-vibration will not be permitted. The result is poor-quality, low-durability concrete with subsequent porosity, premature scaling and disintegration.

Vibrators are used to consolidate concrete – never to spread it. Over-vibration or the incorrect use of the vibrator causes separation of concrete materials. The vibrator should penetrate the entire depth of the layer of concrete being placed but not be allowed to remain in the same spot too long. Ten seconds is about the maximum period necessary to consolidate one area. Usually, less time is needed.

The vibrating head should not be allowed to lie idling in freshly placed concrete or against reinforcing bars that protrude from fresh concrete. The vibrator should not be operated against reinforcing steel that projects into concrete that has not reached its initial set.

2-816D Construction Joints

Construction joints are to be placed only at the locations shown on the plans or at locations approved by the Engineer. The Inspector may authorize placement of a construction joint if a section cannot be completed as planned because of an emergency (such as a plant breakdown). The contractor must request permission from the Engineer to place a construction joint if there is no emergency and the joint was not authorized previously.

A joint must be vertical or horizontal, regardless of the reason for the joint. It must be perpendicular to the line of greatest stress and located where shear is lowest. The lines of the joint must be straight and true. For a horizontal joint, edging strips are used to control the lines of the joint. If a vertical construction or expansion joint is located in a structure, 1 in. (13mm) beveled chamfer strips are placed on both sides of the joint to control the line and prevent spalling or ragged edges. A construction joint with a keyway is shown in Figure 2-8.4.

Figure 2-8.4 Construction Joint

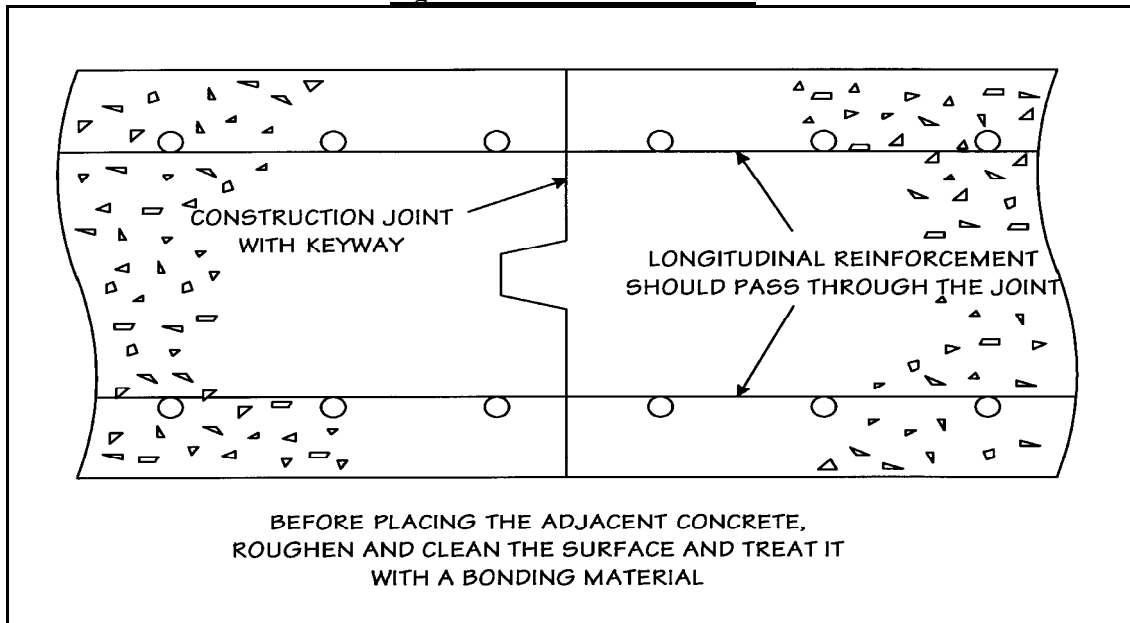

2-816E Placing Concrete in Cold Weather

Cold weather procedures are used from October 15 to April 15, unless the Engineer directs otherwise. The procedures are covered in Article 6.01.03-12 of the *Standard Specifications*. The Inspector must be sure that the heating apparatus is adequate. The contractor must not allow hot spots to develop that might cause premature drying or damage of the material. The contractor must provide a sufficient number of maximum/minimum recording thermometers to record temperatures in each concrete placement undergoing cold-weather protection. There is no additional compensation for the use of heating equipment or for the maintenance of proper curing moisture.

The temperature of the concrete must be no less than 60°F (16°C) when placed in the forms. The temperature surrounding the structure must be kept above 60°F (16°C) for five days after placement, above 40°F (5°C) for an additional nine days, and then gradually lowered to the ambient air temperature. Mixing water must be heated, but its temperature cannot exceed 150°F (65°C). If aggregate is heated, its temperature must be between 50°F (10°C) and 100°F (37°C). The Engineer may vary the temperatures for the mix, water, or aggregate in extreme weather.

The contractor must have tarpaulins, insulating devices, and other suitable materials at the site to enclose or protect all portions of the concrete requiring protection. Materials should be stored close to where they will be used and, after the concrete is placed, installed as rapidly as possible to keep exposure to cold weather to a minimum. The spaces to be heated must be completely enclosed, and the temperature must be kept at required levels by the use of heaters approved by the Engineer.

Before placing concrete, the Inspector should ensure that the air temperature in the forms and the reinforcing steel is at or above the specified temperature. The temperature must be maintained throughout the entire concrete placement operation.

After the concrete is placed in the forms, daily temperature readings are taken by the Inspector to ensure that necessary temperatures are maintained. A record must be kept of these readings on the Inspector's Report. A thermocouple probe and thermometer can assist the Inspector in obtaining readings and improving the accuracy of the representative temperature of the concrete.

The curing period for all structural concrete requiring cold-weather protection must conform to the cold-weather protection period except if the normal curing period is longer. The concrete must be covered after the initial set. Proper curing moisture must be maintained at all times.

2-816F Curing

Curing is covered under Article 6.01.03-19 of the *Standard Specifications*, "Curing Concrete".

Proper curing improves the three most desirable characteristics of concrete: strength, water tightness, and durability. There should not be a tendency to neglect the curing of concrete walls, abutments, piers, and other features of a structure where forms may be stripped early.

The strength of concrete is increased about 50 percent by keeping it damp the first seven days instead of allowing it to dry out rapidly. Moist curing is an aid to producing watertight concrete. As the cement paste hydrates, additional solid matter is formed, filling in spaces between the cement particles. The more complete the hydration process, the denser the concrete. In addition, moist curing improves the durability of concrete and prevents checking and dusting.

Liquid membrane-forming curing must not be used for bridges. Some of the methods that may be used are described below.

- *Flooding.* Units of structures that will be below water in the completed structure – bottom slabs of culverts, footings, struts, etc. – may be gradually flooded when approved by the Engineer after the concrete is 12 hours old. The temperature of this water should be maintained at 35°F (2°C) or above for the specified curing time.
- *Burlap.* Two layers of burlap must be used. Successive strips of burlap are overlapped a minimum of 6 in. (150 mm). The second burlap layer is placed not less than 45 degrees to the first layer, or in lieu of this, the 6 in. (150-mm) overlap of the second layer may be placed midway between that of the first layer. The material must be thoroughly saturated by immersion in curing water for at least 24 hours prior to placement and must be kept saturated throughout the time specified for curing.
- *White Opaque Polyethylene Backed Non-woven Fabric.* One layer of white opaque polyethylene backed fabric must be used. Successive strips are overlapped a minimum of 6 in. (150 mm) The material must be thoroughly saturated by immersion in curing water for at least 24 hours prior to placement and will be kept saturated throughout the time specified for curing.
- *Cotton Mats.* One layer of cotton mat material is used and must be kept thoroughly saturated with curing water prior to placement and throughout the time specified for curing. The material must be kept in tight contact with the concrete.
- *White Opaque Burlap Polyethylene Sheeting or White Opaque Polyethylene Film.* The white opaque burlap polyethylene sheeting is placed on no less than one layer of wet burlap with the burlap side of the sheeting facing down. White opaque polyethylene film, if used, is placed on no less than two layers of wet burlap. Only one layer of cotton mats is required in any usage. The materials may only be used on top of the wet burlap or cotton mats if the surfaces are unobstructed, flat and reasonably level.

Adjacent mats or sheets must be lapped no less than 12 in. (300 mm). The ends are brought down around the sides of the concrete being cured and securely fastened to make an air-tight seal.

The white opaque burlap polyethylene sheeting or the white opaque polyethylene film must remain in place for the same length of time as required for burlap or cotton mats. The protective coverings need not be wetted down. However, the covered burlap or cotton mats must be kept wet for the period specified.

2-816G Finishing Concrete Surfaces

The Inspector should refer to Article 6.01.03-21 of the *Standard Specifications*, “Surface Finish”.

Immediately following the removal of forms, all fins and irregular projections must be removed from all surfaces, except from those that are not to be exposed or not to be waterproofed. On all surfaces, broken corners or edges and any cavities must be thoroughly cleaned and, after having been kept moist, are carefully pointed and trued with a mortar of cement and fine aggregate mixed in the proportions used in the grade of the concrete being finished. Any excess mortar at the surface of the concrete must be removed. The mortar patches are to be cured. Construction and expansion joints in the completed work must be carefully tooled and cleaned. Joint filler is exposed for its full length with clean and true edges. Resulting surfaces must be true and uniform.

The *Specifications* contain a table of finishes that indicate the type of finish to use by structure component. The components are finished with either a float, grout clean-down, or rubbed finish as described in the *Specifications*.

2-816G.1 Horizontal Surfaces

All upper horizontal surfaces, such as the tops of parapets, copings, and bridge seats, must be finished by placing an excess of concrete material in the forms and striking it off even with a wood template. Tops of handrail (posts and caps), headwalls, parapets, wingwalls, and barriers are steel troweled to a smooth, dense surface.

The bridge seat bearing areas of the substructure masonry must be finished to the elevations shown on the contract documents. The contractor will check the elevation of each bearing area prior to finishing ensuring conformance with the plans. Each area must be checked for level in all directions using a spirit level, and adjustments must be made prior to the setting of the concrete. The area is steel troweled to a dense, flat surface. Bearing areas that are not flat after final finishing must be ground to achieve an acceptable surface. A bearing area is not accepted if it is at an elevation below that of the surrounding masonry.

2-816G.2 Sidewalks and Safety Curbs

The concrete should be struck off with an approved screed to the elevation and slope specified in the contract documents. It must be wood-floated to give a uniformly gritty surface free from depressions or high spots. The joints must then be edged with the appropriate edging tool. Curbs are stripped and finished as soon as possible.

2-816G.3 Culvert Slabs

The tops of culvert slabs that are not part of the roadway and invert slabs must be screeded either by hand or machine and have a float finish. The allowable surface tolerance must be within $\frac{1}{4}$ in. (6 mm) of the grade specified in the contract documents. Inverts of culverts having a span of less than 10 ft (3 m) need not be straight-edged.

2-817 Superstructures**2-817A Steel Bridges**

Steel bridges are usually designed with steel superstructures constructed of structural steel and concrete. Their substructures are usually constructed of concrete. Further design-related definitions and information can be found in the *ConnDOT Bridge Design Manual* and the Department's *Steel Construction Manual*.

There are two types of steel superstructures: composite and non-composite. In a non-composite steel-beam bridge with a reinforced concrete deck, each beam carries the dead and live load transmitted to it by the concrete slab. In a composite bridge, shear connectors are welded to the beams, so that after the concrete slab is placed, the slab and the beams act together as composite sections to carry the loads. A sketch of shear connectors is shown in Figure 2-8.5.

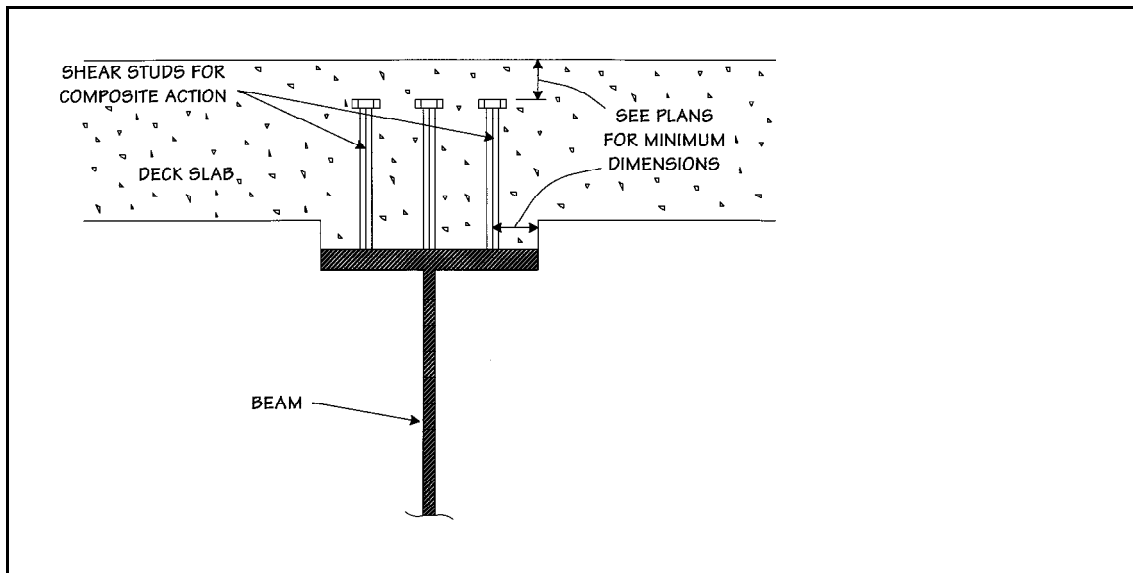
Figure 2-8.5 Shear Connectors**2-817B Box Girders**

Steel and post-tensioned concrete box girders are now in use. Stay-in-place forms are generally not allowed for building concrete decks on box girders.

2-817C Temporary Bridges

The construction of a temporary bridge may be included in the project, usually as part of stage construction.

The contractor is responsible for the design of a temporary bridge according to the contract specifications. On complex projects, the Department will provide a temporary bridge design on the plans. Shop drawings are always submitted to the Department by the contractor for review.

2-817D Prestressed Bridges

Prestressed concrete superstructure units of various shapes have been adopted for use as economical bridge-deck components. The more common prestressed units and types are:

- *Standard Prestressed Concrete Slabs.* These are hollow, rectangular concrete units with central, longitudinal voids. A unit may serve as both girder and deck surface for simple-span structures, although a bituminous or cementitious wearing surface may be applied. Normally, they are not used for spans over 65ft (20m) in length.
- *Standard Prestressed Concrete Box Beams.* These are similar in shape to standard prestressed-concrete slabs but usually are deeper, used for spans up to 105ft (32m). They can be covered with a bituminous or cementitious wearing surface.
- *Standard Prestressed Concrete Girders.* These are I-shaped units used primarily as girders that normally are used with conventionally reinforced concrete decks. The span limit is 120ft (37m).
- *Precast Reinforced Concrete Arch.* Each unit is a concrete arch constructed of three sided, reinforced, monolithically precast sections with open ends of the size as shown on the plans. The units are tied together with transverse strands that are post-tensioned as directed by the Designer.

2-817D.1 Strength

The strength of the concrete in the superstructure units must be as shown on the plans, as defined by the following:

- f_c – the required 28-day compressive strength.
- f_{ci} – the required compressive strength at the time the strands are pretensioned.

2-817D.2 Camber

Camber is defined as the slight arch or convex curvature provided in beams to compensate for dead-load deflection. The camber of the prestressed superstructure units when delivered to the job site should approximate the value of the estimated camber. The estimated camber is computed on the basis that the superstructure units are pretensioned at the prestress plant when the concrete has attained the required compressive strength (f_{ci}), as shown on the contract plans. Too great a camber can result from the introduction of an excessive prestress force, but usually it is caused by pretensioning the superstructure units before the required concrete strength (f_{ci}) has been reached. If the camber is excessive (over or under by approximately 50 percent of the estimated camber), the Inspector should notify the Assistant District Engineer.

2-817D.3 Bearing Areas

The Inspector must check the bottom of each superstructure unit at both bearing areas for trueness of plane surface. The check is done before the superstructure unit is erected to ensure uniform bearing between the superstructure unit and the elastomeric bearing pads. The bearing surface of the bottom of a superstructure unit must lie in a plane that is parallel to the plane passing through the top of the bearing pads. The allowable deviation from a true plane is $\pm 1/16$ in. (± 1.5 mm), as specified in the *Manual for Inspection of Prestressed Concrete* presented by the joint AASHTO-PCI Committee.

2-817D.4 Unacceptable Units

The Laboratory notifies the supplier of all unacceptable units delivered to the site. Copies of the notifications are sent to the appropriate District Office. Field inspectors must ensure that the beams delivered to the site are found acceptable by the Laboratory. If the beams are delivered to the site and have not been accepted at the plant by the Laboratory, the beams must be rejected and returned to the supplier. Out-of-tolerance beams must not be accepted on site, regardless of any understanding that remedial corrections will be performed in the field.

2-817E Anchor Bolts and Bearings

Anchor bolts and bearing assemblies must be accurately positioned or set prior to placing concrete for the bridge seat. Anchor bolts must be set in formed holes in accordance with details and dimensions shown on the plans. The space around the anchorage material is completely filled with nonshrink, nonstaining grout. The work is done as noted on the plans or as ordered by the Engineer.

Frequently, the provision for anchor bolts becomes a part of the superstructure work. In such instances, it is not advisable to drill holes for the anchor bolts. The positioning of anchor bolts must be performed before the substructure concrete is placed. Because there is very little room for adjustment, the anchor-bolt layout

must be accurate. The bolt holes must be in the correct locations and perpendicular to the plane of the bridge seat.

The layout procedure is as follows:

- After forms are constructed for the concrete substructure, the centerline of the bridge is located for the abutments and piers.
- The centerline of bearing is located for the first abutment. The angle between the centerline of the bridge and the centerline of bearing is checked to see that it is exactly as planned. Any discrepancy must be corrected by adjusting the centerline of bearing.
- The distance is checked between the centerlines of bearing for the first abutment and the second abutment or pier, applying corrections for temperature and measuring tape sag. After the correct distance between the centerlines of bearing is established, an adjusted centerline of bearing is located on the second abutment or pier. The centerlines of bearing for the remaining piers or abutments are located in a similar manner.
- For each abutment and pier, the centerline of the girder and the centerline of the anchor bolts are permanently located. The lines are used to determine the position of the anchor bolts and to set the masonry plates.
- After the anchor-bolt holes are cast into the concrete and the bearing is prepared, each masonry plate is marked with the centerline of the girder. The centerline of the anchor bolts is marked on the bearing seat. The plate is set so that the marks on the plate coincide with the marks on the bearing seat.

The anchor bolt positions must be adjusted to accommodate expansion of the girders. Rockers will be tilted toward the abutment if the temperature is above the mean temperature indicated on the plans and away from the abutment if the temperature is below the mean temperature indicated on the plans.

2-817F Elastomeric Bearing Pads

The purpose of the elastomeric bearing pad is to transmit the superstructure loads to the substructure and to accommodate the expansion, contraction, and horizontal movements of the superstructure. This should be accomplished without slippage between the superstructure and the elastomeric bearing pad or between the elastomeric pad and the substructure. A sketch of an elastomeric bearing pad assembly is shown in Figure 2-8.6.

Figure 2-8.6 Elastomeric Bearing Pad Assembly

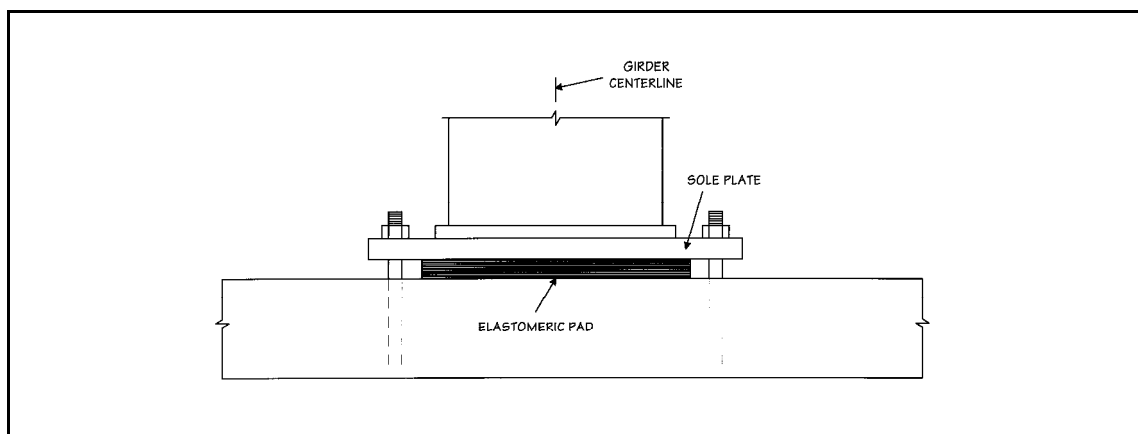

2-817F.1 Materials

The dimensions of the pads must be as shown on the plans, with allowable tolerance indicated in the specifications. The two most critical dimensions are the taper of the pad, or pad thickness if no taper is required, and the location of the laminae, if a laminated pad is specified. The taper (or thickness) of the pad must be correct to obtain uniform bearing between the pad and the superstructure unit, resulting in uniform stresses within the pad.

The laminae within the pad, if present, have the effect of dividing the pad into a series of pads. Therefore, the distance between laminae is equivalent to the thickness of each “internal pad” and must be of the proper dimension. The Materials Laboratory cuts the sample pad to determine the location of the steel laminae. The position of the laminae can also be determined after the superstructure unit has been set on the pad. The weight of the superstructure unit will produce a series of bulges on the side of the pad. The valleys, or the portions of the side that do not bulge, indicate the positions of the laminae. The required position of the laminae will be as shown on the plans, with the allowable tolerances stated in the specifications. No part of the laminae may be exposed.

2-817F.2 Bearing Area

Unless otherwise stated in the specifications or plans, the elastomeric bearing pad is set on a prepared concrete seat. The seat must be level and at the elevation shown on the plans, and it may not vary from a true plane by more than 1/16 in. (1.5 mm) over the entire surface on which the elastomeric bearing pad is to rest. Normally, no grout will be used to level the seat. If shims are needed, elastomeric shims will be used prior to installation of the elastomeric bearing pad.

When the elastomeric pads are used without masonry bearing plates, the masonry bearing surfaces must be ground to remove all laitance before the application of the adhesive. The surfaces of the concrete bearing areas that will be in contact with the bearing pads and the full contact area of the bearing pad will be coated with the epoxy adhesive. After the adhesive is applied and the pads are set in place, blocking or other approved mechanical methods may be used to secure the pads in their final position until the adhesive sets up.

2-817F.3 Installation

The pads and abutting surfaces must be given a final cleaning to assure that they are free from all dust, dirt, oil, grease, moisture, and other foreign substances. Cleaning may be done with an approved solvent that is compatible with the adhesive. The adhesive must be mixed and applied in conformance with the manufacturer's recommendations.

Surface temperatures and predicted ambient air temperature for the next four hours must be 50°F (10 C) or higher at the time of application, unless otherwise specified in the contract documents or recommended by the epoxy adhesive manufacturer and approved by the Engineer.

After application of full dead load, there must be uniform bearing between the superstructure unit and the elastomeric bearing pad and between the bearing pad and the concrete seat, uniform deflection of the pad, and no tearing of the elastomer.

2-817F.4 Nonconforming Work

Any deviation from the above, or any nonconformance to the requirements of the plans or specifications, must be reported immediately to the Project Engineer. Refer to Section 1-325 for usage of Non-Compliance Notices.

2-817G Pot Bearings or Disc Bearings

Pot or disc bearings must provide for rotation in all directions. Expansion bearings have sliding surfaces of polytetrafluorethylene (PTFE) to accommodate expansion and, thus, sliding in the directions indicated on the contract plans. A sketch of a pot bearing is in Figure 2-8.7.

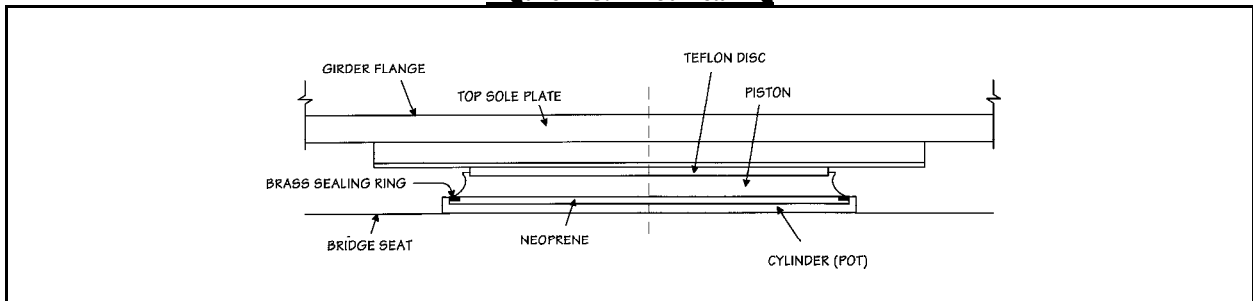
Figure 2-8.7 Pot Bearing

The Inspector must be aware of possible problems during normal use of the bearings:

- The bearing may be subjected to rotation beyond its capacity during installation.
- The electrical ground may be attached to the bearing, causing current to travel through the bearing or causing arcing of the ring against the side of the pot.
- Paint may be applied inadvertently to PTFE or stainless steel surfaces. The surfaces are intended to slip against each other. The paint impedes the movement.
- Duct tape or such, used to secure the bearing during transportation, may be left in place between the teflon and stainless steel surfaces.
- Bearings may be handled and stored improperly. They can easily be contaminated with foreign material.
- The pot bearing may “ooze” after loading.

As with all fabricated structural steel, the contractor must submit shop drawings to the Engineer for approval before fabrication of any bearing. The contractor is responsible for coordinating the work between the bearing manufacturer and the subcontractor installing the bearings. Pot bearings are preassembled in the fabricator's shop before shipping to the job site. They should not be disassembled in the field.

Before installing the bearing, the contractor certifies to the Engineer that an experienced representative of the bearing manufacturer will be available to the contractor at the site to give aid and instruction. The bearings must be placed at the predetermined location at the time of structural steel erection or, in the case of cast-in-place concrete superstructures, before the superstructure is cast. All temporary restraints are removed as directed by the bearing manufacturer.

Expansion bearings are adjusted from the normally aligned position to allow for the ambient temperature at the time of erection or casting. In addition, the bearings are adjusted horizontally on the anchor plates to

properly fit the steel superstructure members being erected. After all adjustments and at the approval of the Engineer, the bearings are welded to the anchor plate.

2-817H Expansion Dams

In setting expansion dams, the length of the expansion dam on the plans is adjusted for the difference between the existing temperature and the mean temperature indicated on the plans. The following formulas are used:

T = mean temperature indicated on the plans in degrees Fahrenheit (Celsius)

E = existing temperature in degrees Fahrenheit (Celsius)

L = length of the structure contributing to expansion in inches (millimeters)

When the temperature is above T, the steel expands. The increase in the length of the girder because of the difference in temperature is:

$$0.000\ 0116 \times (E - T) \times L \quad (0.000\ 006\ 5 \times (E - T) \times L)$$

If the other end of the girder is fixed, existing expansion space should be set smaller than that shown on the plans by subtracting the calculation result. If the other end of the girder is free to expand or contract, the existing expansion space is smaller by one-half of the calculation result.

When the temperature is below T, the steel contracts. The decrease in the length because of the difference in temperature is:

$$0.000\ 0116 \times (T - E) \times L \quad (0.000\ 006\ 5 \times (T - E) \times L)$$

If the other end of the girder is fixed, the existing expansion space should be set larger than that shown on the plans by adding the calculation result. If the other end of the girder is free to expand or contract, the existing expansion space is set larger by one-half of the calculation result.

If the mean temperature is not indicated on the plans, T is assumed to be 50°F (10°C).

Figure 2-8.8 Rocker Setting

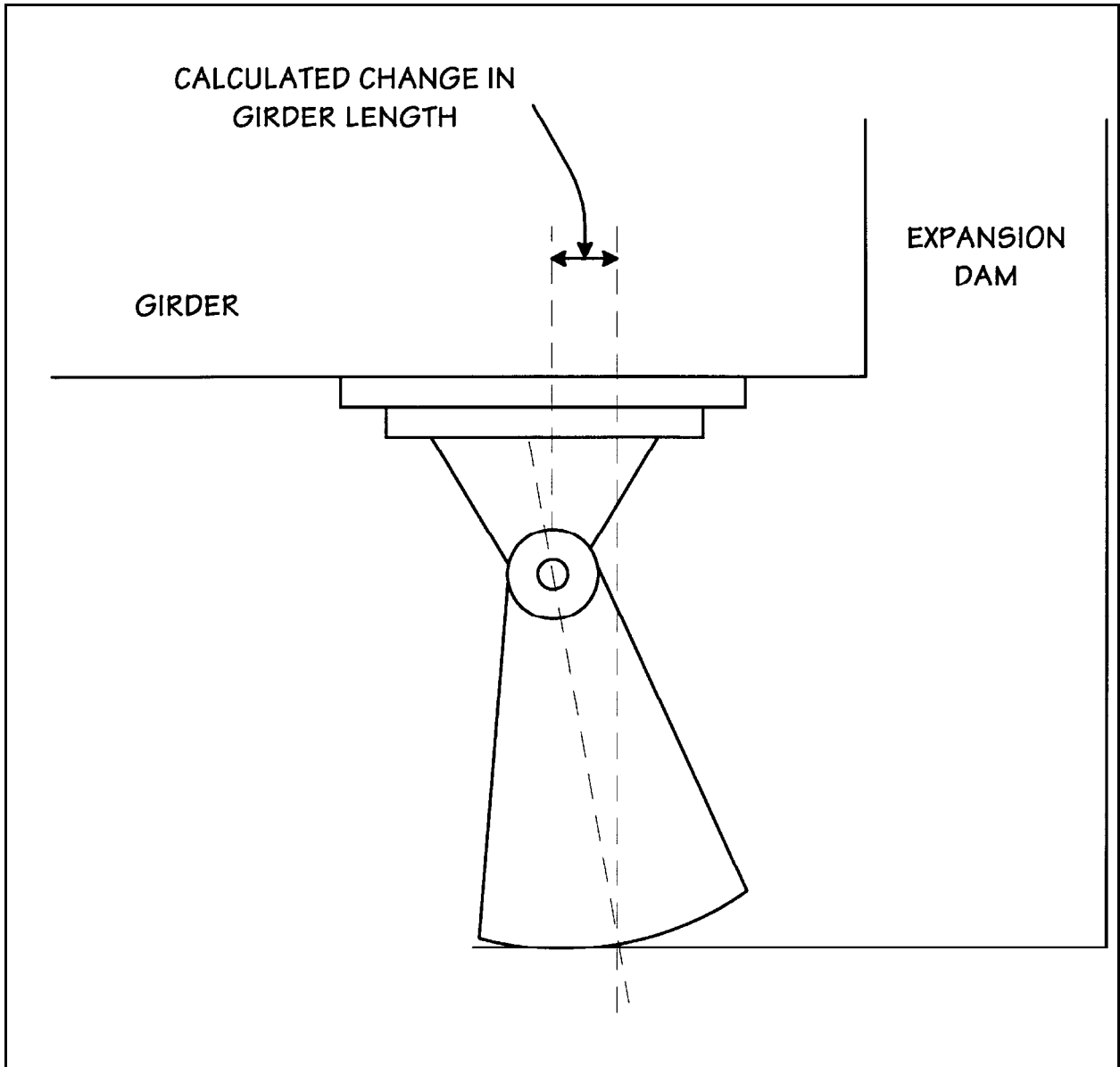

A rocker setting is shown in Figure 2-8.8.

It is important to remember that a further allowance must be made for the increase in length of beam that may be produced by reduction in camber resulting from the application of dead load. In addition, an allowance for concrete creep must be made for cast-in-place concrete boxes.

2-817I Steel Erection

Article 6.03 of the *Standard Specifications* must be thoroughly reviewed by the Inspector prior to erecting any steel. It is very important that steel erection proceed in accordance with the approved procedure. Any deviation in crane size or lifting locations should not be permitted. All details of the erection of steel members must be discussed in the approved erection plan.

When structural steel is being erected, it is very important that diaphragms are installed and bolted as girders are placed to stabilize the girders and prevent accidents. The Inspector must not allow work to be stopped for the day until all erected beams are stabilized by the proper installation of diaphragms and keeper blocks if necessary. The Inspector must never permit unbraced steel to be left overnight.

2-817J Shear Connectors

Shear connectors must be the diameter and height specified on the plans and must be installed in accordance with the prescribed spacing on the top flange of steel girders. Shear-connector samples of the type described on the plans must be submitted for testing and approval well in advance of the anticipated use. The Inspector may refer to Article 5.08.03 of the *Standard Specifications* for field testing procedures.

2-817K Welding

Welding is a critical function in the construction of steel bridges and requires constant diligence of the Inspector. The Inspector must thoroughly review Article 6.03.03-6 of the *Standard Specifications*, "Welding," AASHTO and American Welding Society (AWS) codes, and the ConnDOT *Steel Construction Manual*.

Field welding must be performed by the shielded metal arc method, unless otherwise permitted by written consent of the Assistant District Engineer. Welding will not begin until all welding procedures are submitted by the contractor and accepted by the Department.

2-817K.1 Welder Qualifications

To work on the project, either in the field or shop, a welder (1) must possess a valid Department welding card and (2) must have welded on a Department project or on a project acceptable to the Department within 12 months. The Chief Inspector must personally inspect and copy each welder's card before he begins work on the project. The welder's identity must be verified by a positive means of identification (driver license, etc.).

The welder is required to requalify through examination if he cannot produce a suitably approved welding certificate, dated not more than 12 months previously, from a welding agency acceptable to the Engineer. Examinations are at the expense of the individuals and are given at independent testing agencies approved by the Laboratory. The Laboratory issues the welding card.

2-817K.2 Inspection

The contractor is required to employ a Certified Welding Inspector with a DOT welding certificate to perform fabrication-and-erection or verification inspection of the work for conformance with all applicable codes.

The Inspector must be equipped with a welder's mask to inspect a weld while it is being executed. In executing a weld, the molten metal forms a pool, and in observing this pool the Inspector can detect the presence of foreign matter such as slag, water, grease, paint, or other substances that impair the density or

structure of the weld. A Certified Welding Inspector can observe the depth of penetration into the base metal.

Before any field welding is started, the structure must be adjusted to the correct grade and alignment, and provision must be made to prevent distortion during welding. All surfaces to be welded must be free of paint or primed as specified in Article 6.03.03-37 of the *Standard Specifications*, “Shop Painting,” and must be thoroughly cleaned. The edges of plates and sections to be welded will be tightly closed by service bolting, clamping, or other approved methods.

2-817K.3 Weld Quality

Proper current, voltage, and welding speed are necessary to make a good weld, and varying from normal in any of these factors affects the quality of the weld. Figure 2-8.9 shows various combinations of current, voltage and welding speed and the results that can be expected.

Figure 2-8.9 Weld Quality Factors

Current	Voltage	Speed	Results
Normal	Normal	Normal	Smooth contour, uniform cross section with slightly convex face, straight edges, ripples spaced closely and uniformly
Low	Normal	Normal	Shallow, poorly defined crater, poor fusion
High	Normal	Normal	Shallow, poorly defined crater, poor fusion, no pronounced overlap
Normal	Low	Normal	Penetration small, fusion poor, porous weld.
Normal	High	Normal	Fusion poor, bead wide with large splatters
Normal	Normal	Low	Fusion fair, bead wide and overlapping, penetration good
Normal	Normal	High	Fusion fair, insufficient deposit of weld material

2-817K.4 Defective Welds

After the weld has cooled and the slag has been removed, it must be cleaned with a wire brush. Common defects in the weld that the Inspector should detect are treated in the following manner:

- *Overlap.* If the edge of the weld metal is loose and protrudes over the base metal, poor fusion is indicated. The weld is cut out, and a new weld is made.
- *Undercutting.* There is an insufficient deposit of weld metal, or the base metal is necked down. The weld is cleaned and built up to standard by depositing weld metal.
- *Shallow Craters.* Poor penetration is indicated. Unless the weld is for sealing purposes only, the weld is cut out, and a new weld is made.
- *Pits, Porosity and Gas Pockets.* The weld is cut out, and a new weld is made.
- *Irregular Spacing of Ripples.* This is not harmful unless an exceptionally wide space occurs, causing a weak spot. If full strength is important, the length of the weld is increased.

The sizes and lengths of all fillet welds are checked against the plans. A weld slightly larger or longer than specified is acceptable, but the weld may not be smaller or shorter than specified. Any questions may be directed to the Materials Testing Laboratory.

The Inspector must ensure that the welder makes consistently satisfactory welds. If the welds appear to be of inferior quality, the Inspector notifies the Laboratory for review by an AWS Certified Welding Inspector employed by the Laboratory. For welders who perform satisfactory work, the Inspector must sign and date the welder's card.

2-817L Bolted Connections

Bolted connections are not to be used unless shown on the plans. The bolts must be of the size and type specified and must be installed in accordance with Article 6.03.03-19 of the *Standard Specifications*. It is important that sample bolts are taken to assure quality and approval and to ensure that the bolts are not foreign made. Bolt manufacturers can be identified by the markings on the head. Bolts should be checked for adequate torque. In some cases, load- indicating washers can be used and inspected according to the manufacturer.

2-817M Utility or Conduit Installation

Utility installations covered by contract items must be installed as shown on the plans.

Steel conduits usually are placed within the parapet area of a bridge deck. They must be continuous, extend to the proper height above the top surface of the parapet at roadway lighting unit locations, extend from the wingwalls the proper distance below the proposed roadway surface, and be satisfactorily capped. Adequate provision must be made for the temperature movements of the structure by installing expansion sleeves where directed and especially at the expansion joints of the structure. All conduits must be bent in an approved bending device to the radii limits prescribed in the electrical code.

2-817N Bridge Deck Procedures

Article 6.01.03-9 of the *Standard Specifications*, "Concrete for Bridge Decks," requires the contractor to submit plans for deck screeds, grades, and concrete placement methods and sequences. The plan is reviewed by the Inspector.

2-817N.1 Grades, Formwork and Screed Rails

The contractor may elect to screed a concrete deck slab either longitudinally or transversely, depending on the way deemed best for the size of the deck.

As a rule, the camber noted on the plans refers to the amount of camber required in the beam to offset the deflection due to the dead load to be carried by the beam plus the weight of the beam itself. The amount of camber to remain in the completed slab varies with the length of the span. In addition, screed settings are affected if the bridge is on a vertical curve.

After grades are computed for the predetermined reference points, the deflections and the amount of camber desired are applied to the computed grades to give a working grade. The working grade is used to build the forms and to set the adjustable screed.

Immediately after the steel erection is completed, elevations are taken on the beams at the reference points. No significant dead load (including deck forms) may be placed on any beam until all elevations of the steel are taken. It is recommended on larger bridges that survey elevations be taken as soon as possible, at a fairly constant temperature. Although deflections and camber are significant to design, the deck thickness is the critical element in the field. The deck thickness, as computed from the horizontal and vertical geometry of the roadway, should not be less than the thickness specified on the plans.

The beam elevations are then subtracted from the working grade, and the difference between the two should be marked on the beams in inches (millimeters). It is advisable to do the marking with something durable, such as paint, as the reference markings are used for constructing the slab forms and setting the screed. After the screed is set and necessary adjustments are made, the slab is ready to be placed. Unless it is accidentally displaced, no further adjustment of the screed is necessary, as allowances for deflection and camber are made in computing the working grade.

Additional deflection allowances may be noted for structural sidewalk, safety walk, parapet or median components, and the proper deflection allowances must be made in the grades of the formwork.

On bridges with a horizontal curvature, forms between reference points are checked radially to the base line, not necessarily perpendicular to the girders.

Particular attention must be given to the location and grade of the parapet rustication and chamfer strips. The plan details covering reductions in the depth of the rustication strips and parapet coping chamfer at sign-support bases or luminaire bases merit careful review and consideration.

The lack of sufficient concrete cover over deck reinforcement is a major cause of premature deck deterioration. Thus, it is necessary that bridge decks be constructed in strict conformity with plan dimensions, and sufficient care must be taken to ensure that the clear cover over the reinforcement is as shown on the plans and within allowable tolerances. The Inspector should verify compliance with plan dimensions by an adequate number of measurements of the reinforcing bar locations before placing concrete. The epoxy-coated bars used in the deck must be checked for nicks, cutoffs, etc., and touched up properly in the field. This should ensure continuous protection of the steel to prevent rust.

2-817N.2 Placing Concrete

Unless otherwise specified in the contract documents, Class F concrete must be used for bridge decks. The air content of the placed concrete must be maintained within the limits specified to provide for durability. Deck concrete generally is placed with concrete buckets, pumps, or conveyors. The manner of placement and finishing is very similar to that for concrete pavement. See Volume 2, Chapter 7, "Concrete Pavements."

The Inspector must be completely familiar with the deck concrete placement sequence as shown on the plans. Generally, placement sequences are provided for multi-span continuous-beam bridges. If the contractor wishes to modify the sequence from that shown on the plans, a written request must be submitted to the Engineer for approval prior to placement of any concrete. The placement sequence is critical to the construction of the bridge and the loading of the superstructure, particularly if the beams are skewed from the substructure. It is also important to consider the structural stability of the bridge during the unbalanced loading that occurs during placement of the deck concrete.

If the deck placement will occur over a fairly long time in a continuous operation, set retarders should be used in a modified concrete-mix design to allow finishing of the surface.

If practicable, placing operations commence at the lowest exterior grade point of the structure. The concrete must be spread evenly in layers, thoroughly vibrated – especially around haunches, fillets, rustication strips and shear connector devices – brought to the final grade as established by the screed rails, and finished by an approved mechanical finisher.

The machine-struck surface will be smoothed with an approved lute, straight-edged, and textured with a broom drag. The surface may not vary more than 1/8 in. (3 mm) if checked with a 10 ft. (3m) straightedge. The broom finish for decks is omitted if a waterproof membrane is applied.

The grade at the curb line should be true to prevent water from standing along the curbs. Workers should not be allowed to walk in the concrete after it has been screeded; suitable bridges must be provided to gain access to the various parts of the work. Screed rails or supports for screed rails may not be placed in the roadway area, unless specifically outlined on the plan or as directed by the Engineer.

The Inspector must assure that the concrete pump hoses or pipes are primed throughout with a lubricating grout. Approximately 5 gallons for every 50 feet (1.25 liters for every meter) of hose is needed to properly coat the inside surface. When almost all the priming grout is pumped out of the receiving hopper, the first load of deck concrete may be discharged into the hopper. Then pumping can proceed slowly until the excess grout and water are removed, and the true mix is flowing.

At the outlet end of the hose, the pipe must be located high enough above the form so that the mix can be distributed easily, but not so high as to permit a free fall that leads to segregation. Concrete should not be allowed to drop more than 3 ft. (1m) from the chute to the form or to the previously deposited concrete.

The Inspector should keep a number of basic requirements in mind:

- The concrete hauler must discharge directly into the receiving hopper.
- An adequate supply of clean water is necessary for flushing out the cylinder system, and provision must be made for disposal of the flushed water.
- Proper mix design is essential.
- If pumping downhill, the pump should have a certain resistance to work before the pipeline reaches the downward incline. This resistance can be provided by going uphill for a few feet (meters) before turning downward.
- Weather can affect pumping performance. In hot weather, pipe exposed to the sun can be covered with wet burlap.
- A contingency plan should be available to complete the concrete placement in case of equipment breakdown.
- The pumping operation can commence at the farthest point from the pump and work toward the pump.

2-817N.3 Finishing

All exposed external surfaces of structural concrete are finished as prescribed in the Specifications. Deck surfaces receive a broom finish unless a waterproof membrane is to be applied. The top surfaces of safety walks and parapets receive a float finish.

If specified in the contract documents, the deck grooving operation will start after the bridge deck slab has been cured and has attained the minimum compressive strength specified. The bridge deck must be grooved perpendicular to the centerline of the roadway.

The grooves may be cut using a mechanical saw device that leaves grooves 1/8 in. (3 mm) wide, 3/16 in. \pm 1/16 in. (5mm \pm 1.5 mm) deep and variably spaced from 5/8 in. (16 mm) to 7/8 in. (22 mm) apart. The grooves may extend across the slab to within 1 ft. (300 mm) of the gutter lines. All residue resulting from grooving operations must be removed from all surfaces in an environmentally accepted manner. All surfaces will be left in a washed, clean condition.

Volume 2

2-8170 Joints

2-8170.1 Sealants

A sketch of a poured joint seal is in Figure 2-8.10. The joint sealers for structures should be as noted on the plans or as required by the special provisions.

The Inspector must be thoroughly familiar with any joint sealer used. As with other coating systems, a data sheet comes in the box containing the cans of sealer. This data sheet provides the type of information that is needed by the Inspector. The data pertain to only the particular brand being used. Without the data, the Inspector has no way of making a proper inspection unless thoroughly familiar with the brand of sealer from experience. Also of equal importance in sealing joints with any material is the use of a proper bond breaker and backup material. The wrong choice of bond breaker, backup material, or both can mean failure of the joint even though the sealant and workmanship are the highest quality.

The bond breaker must exhibit the following characteristics:

- It must prevent bond between itself and the sealant.
- It must have extremely low tear strength.

Backup materials for joint sealants must do the following:

- control the depth of sealant in the joint
- serve as a supporting medium
- be nonabsorbent or relatively nonabsorbent
- have the ability to be compressed by changing volume rather than shape

Figure 2-8.10 Poured Joint Seal

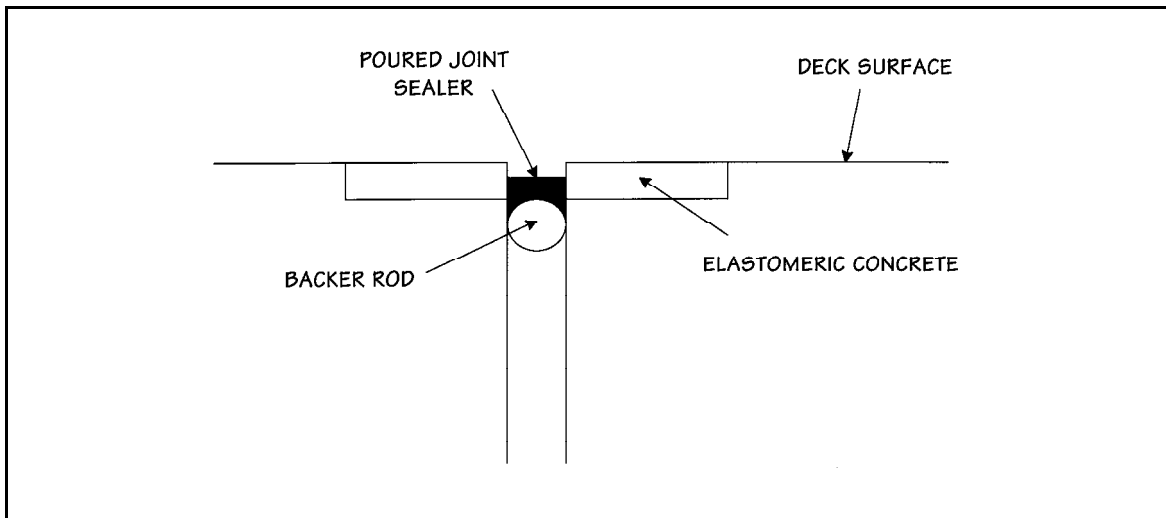

2-8170.2 Expansion Joint Material

Expansion joint material delivered to the bridge site should be stored under cover on platforms above the surface of the ground. It must be protected at all times from damage, and when placed it must be free from dirt, oil, grease, or other foreign substances. All welding will conform to AWS unless otherwise specified in the contract documents. No expansion joint material may be installed prior to approval by the Engineer of all material and installation methods.

Volume 2

The preformed material will consist of the longest length possible with a minimum of joints. Lengths less than 4 ft. (1.2m) must be one piece. The material is cut to a clean, true edge with a sharp tool. Care will be taken to insure straight lines at the joint.

When installing the seal, the contractor must not use any type of equipment that will damage the seal. If the seal is damaged during installation, the contractor must remove and replace the seal at the Contractor's expense.

2-8170.3 Systems and Devices

The transverse compression seals will be one piece for the entire length of the roadway joint. Shop or field splices in the seal are prohibited. Compression seals for longitudinal bridge joints will consist of the longest piece practicable.

Lubricant adhesives must be applied in conformance with the manufacturer's recommendations. If the seal is stretched more than five percent, the contractor will reinstall the seal as directed by the Engineer.

- *Elastomeric Concrete Strip or Box Seal Expansion Joint System.* This system consists of all necessary reinforcing and hold-down bars, and the elastomeric concrete that holds the strip or box seal. An adhesive lubricant will be used to install the strip seal in the steel intrusions. See Figure 2-8.11. *Prefabricated Strip Seal Expansion Joint Device.* This device consists of a prefabricated elastomeric strip seal gland inserted in steel extrusions. The steel extrusions are welded to steel plates that are fastened to existing finger plates with welded studs. It is set in place with elastomeric concrete. See Figure 2-8.12.

Figure 2-8.11 Box Seal Expansion Joint System

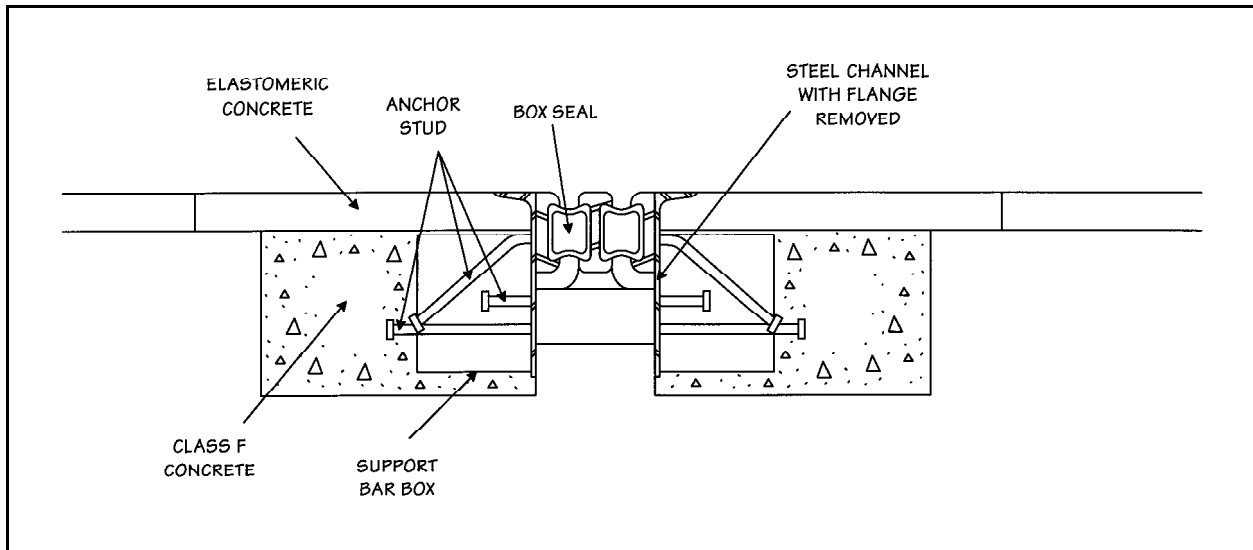
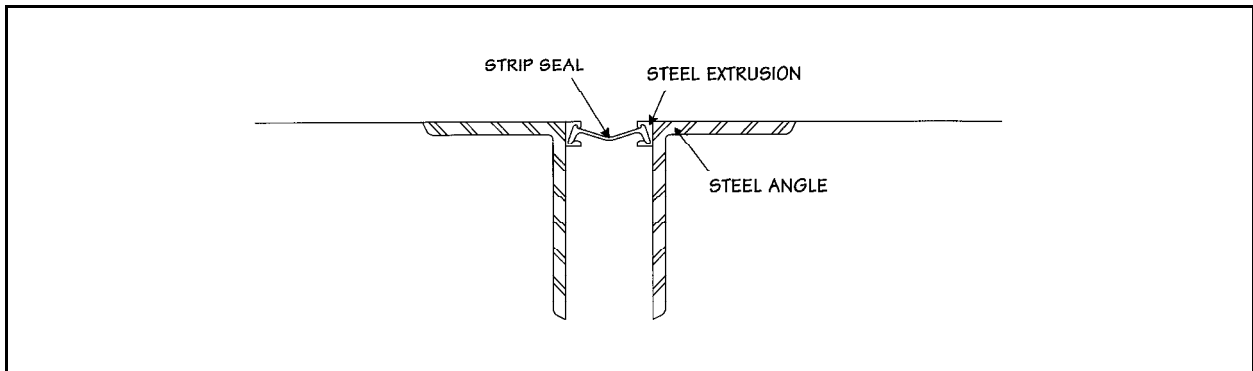

Figure 2-8.12 Strip Seal Joint Device

2-817P Protective Surface Treatment Compounds

If coating materials are used for surface treatments to curb, sidewalk, medians, parapets or any other part of a structure subjected to roadway salts, the Inspector must become familiar with the characteristics of the material well in advance of its application. As contracts normally allow a choice of equivalent brands of materials, the Inspector must be aware of the contractor's choice and retain a data sheet from the vendor for the material.

The data sheet provides information on the following:

- description of epoxy
- advantages
- properties
- effect of material temperature
- effect of curing temperature
- coverage
- how to prepare and use
- limitations
- safety

Because of the critical nature of the material and the factors limiting its use, as well as the factors that may be detrimental to the resultant quality, the Inspector must make every effort to ensure proper preparation and application.

2-818 Bridge Rehabilitation

The storage and load restriction instructions outlined in Sections 2-801A and 2-801B should be thoroughly reviewed and applied to all bridge rehabilitation projects. Special attention should be focused on staged construction where loads from temporary precast barrier curb will affect the structure for potentially long periods of time.

2-818A General

Bridge rehabilitation requires a design-construction approach by the Department and close attention to the details of rehabilitation construction. In addition, as new materials are introduced into the construction industry, the focus on proper preparation, handling, and application of materials becomes more and more important to the success of rehabilitation efforts.

Bridge rehabilitation may involve the repair of or the removal and replacement of bridge decks, the repair of substructure components, the cleaning or replacement of bearings, the strengthening of structural steel members, the repair and protection of the bridge utility conduits and supports, the paving or overlaying of bridge decks, and the proper disposal of all construction debris.

Once the work is underway, the extent or limits of deterioration may be greater than anticipated. As the construction progresses, the Inspector may encounter site conditions very different from those shown in the contract documents. The changed conditions require reevaluation of the design, project goals and objectives, and available budget.

2-818B Utilities

During any rehabilitation construction project, the Inspector must ensure that the contractor is aware of existing utility services (including water, telephone, gas, electrical, and cable) that are located on the bridge or in the bridge parapets.

As a first order of work, preliminary measurements, sketches and photographs of the locations of all existing utilities are documented jointly by the contractor, the Inspector, and the utility company representative. The Inspector inspects the visible utility components to ensure they are in good condition and meet current requirements. If there is any question concerning the condition or serviceability of the existing utilities, the Inspector should contact the Project Engineer.

To avoid unnecessary delays and costs, it is important that utility companies be advised well in advance of any construction that may affect their facilities. This contact occurs during design and pre-construction phases of the work. Inspectors must contact each affected utility company or their designated representative at the beginning of the project and advise them of the pending work.

All existing utilities must be protected against damage during construction, and in nearly all cases uninterrupted service must be maintained.

2-818C Bridge Deck Repair

The repair of deteriorated bridge decks requires:

- removing the existing bituminous concrete wearing surface and membrane (if present)
- locating and marking the deteriorated areas
- removing the deteriorated concrete
- patching the areas
- installing a waterproofing membrane to the deck surface
- overlaying or patching the deck with a new bituminous concrete wearing surface
- installing joints and joint seals

Figure 2-8.13 shows a typical bridge deck repair.

Figure 2-8.13 Bridge Deck Repair

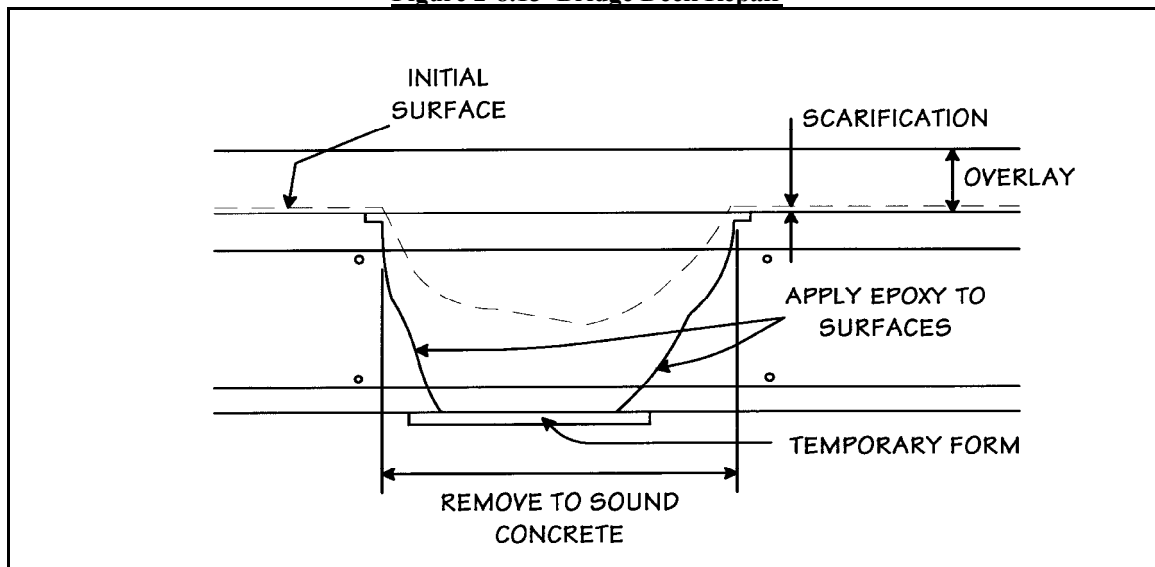

2-818C.1 Removal of Bituminous Wearing Surface

Before removal operations begin, the contractor will submit a list of the equipment to be used and the removal methods for approval of the Engineer.

The contractor removes the existing bituminous wearing surface, using approved means, to completely expose the underlying concrete deck. Damage caused by the contractor is repaired at the sole expense of the contractor. The usual methods of removal are with a backhoe or front-end loader or by milling. Vibratory scarifiers may be used but must be approved before use. Vibratory scarifiers are not allowed on:

- bridge deck spans that are supported with pin and hanger assemblies
- bridges with load restrictions (posted)
- bridges that have been classified to have a specific structural problem awaiting repair

If construction is performed during off-peak hours and traffic uses the roadway at other times, the Inspector should ensure that the contractor installs temporary pavement markings prior to allowing normal traffic to resume. The roadway should be swept clean of construction debris, and all deck areas that may ravel under traffic are temporarily repaired. Smooth transitions should be provided between the abutting approach pavement and the deck. It is preferable to have the transition ramps milled during pavement removal.

If milling of the transition areas is not possible, the Inspector should have the contractor install bituminous concrete ramping from the areas where bituminous concrete was removed to the existing pavement. The preferred taper for ramps is 1:50 or flatter. No longitudinal joint (drop-off) is allowed between lanes.

For overlays up to 2 in. (50 mm) thick, longitudinal-joint ramping may be allowed by the Inspector. For thicker overlays, ramping is not allowed, and the pavement removal will most likely need to be restricted to milling from curb to curb to avoid drop-offs.

2-818C.2 Location and Marking of Deteriorated Areas

The general areas of deterioration are indicated on the plans and are approximate. The actual limits of work are determined in the field.

Before any existing concrete is removed from the structural slab, the contractor should provide the Inspector unobstructed access to the bridge deck. During this time, the Inspector performs an inspection of the structural slab and designates areas where concrete removal is required.

The method currently used to outline the actual deteriorated areas is called “chaining” or “rattling.” A piece of heavy machine chain, 8 or 10 ft. (2.5 to 3 m) long, is held in one hand and snaked back and forth over the surface of the pavement in an S-curve pattern. The sound made by the chain on the concrete surface changes if it passes over a deteriorated or delaminated area. Practice enables the Inspector to accurately define the limits of removal. The limits of the deteriorated areas are outlined with paint as the chaining procedure progresses. Smaller areas close together may be combined into one larger area. For the final determination of the limits of removal, all limit lines must be straight with 90-degree corners.

If, during the chaining process, the Inspector finds an excessive amount of deteriorating concrete, the Inspector should alert the Project Engineer. The Project Engineer, in consultation with Design, will make a cost analysis of patching the deck (versus installing a new deck) before any deck repairs are made.

2-818C.3 Removal of Deteriorated Concrete

Deteriorated concrete may be removed by pneumatic hammer or hydro-demolition methods. The contract documents will specify the removal methods. The contractor will not perform any repair work without prior approval of the Inspector of location, limits, and type of repair.

If the removal of deteriorated concrete extends to a depth of more than one-half of the total bridge deck thickness (mid-depth between the mats of reinforcing steel), then all remaining concrete within the outline of the patch must be removed, and the deck will be repaired for its full thickness.

2-818C.3a Protective Shields

The contractor must protect the public against injury and damage from demolition operations when removing portions of existing bridge-deck slabs. If deck removal is performed over or near roadways, railroads, or waterways, the contractor must furnish and erect temporary protective shields to prevent any material or debris from entering the areas.

The protective shields must be approved by the Inspector. Flooring and siding can have no cracks or openings through which material particles may pass. The shields must be able to support 150 lbs/ft.² (730 kg/m²) over their entire area, in addition to their own weight.

A minimum under-clearance of 14.5 ft. (4.4 m) must be maintained over the roadway pavement and shoulders. No portion of the shield, including connection devices, may encroach on this under-clearance. If less than 16.0 ft. (4.9 m) of under-clearance is provided, the contractor must furnish and erect signs indicating the exact minimum under-clearance. In addition, the **Chief Inspector must inform the supervisor of Motor Transport Services Unit of the reduction in vertical clearance.** See Section 1-108 “Change in Travelway Clearances and Bridge Capacity Ratings”. The signs and their locations must be approved by the Inspector. They must be removed when the original under-clearance is restored and will become the property of the contractor.

After the Engineer determines that the protective shields have served their purpose, they will be removed and become the property of the contractor.

2-818C.3b Removal by Pneumatic Hammer

The outline of each removal area must be saw cut to a depth of ½ in. (13 mm) with an approved power saw capable of making straight cuts. If sawing is impossible or impractical, the areas may be outlined by chisel

or other approved means. If reinforcing steel is encountered within the saw cut, the depth of cut will be adjusted back to ½ in. (13 mm) after the shallow steel is passed.

Deteriorated concrete is removed by pneumatic hammers approved by the Engineer. The weights of the hammers may not exceed 30 lbs. (14 kg). A 15 lb. (7 kg) (maximum) chipping hammer is used for removing concrete below the top mat of reinforcing steel. Care must be taken not to damage the reinforcing steel in any way. Pneumatic hammers may not be placed in direct contact with reinforcing steel. If over-breakage of the concrete saw-cut edge results in a featheredge, the featheredge is re-sawed to create the required vertical edge.

The minimum depth of concrete removal is 1 in. (25 mm). The required depth of removal is determined by inspection of the fractured aggregate over the entire removal area. If the large aggregate fractures – instead of “popping out” (losing its bond with the cement matrix) – the concrete is sound. Care must be taken to remove fillets from the corners of intersecting removal limit lines. All intersecting removal lines should be squared.

If reinforcing steel is surrounded by deteriorated concrete, has at least one-half of its surface area exposed, or has less than 1 in. (25 mm) of cover, the depth of concrete removal must not be less than ¾ in. (19 mm) below the bottom of the steel.

If the existing reinforcement bar is damaged or corroded, it must be cut out and replaced with new reinforcement bar. New reinforcement bar is attached beneath existing reinforcement bar with a minimum lap conforming to the plans or as directed by the Inspector. Reinforcing steel that is to be left in place is cleaned of all concrete. Small concrete fragments may have to be removed with hand tools.

The concrete surface and reinforcing steel that will receive patching material must be blast-cleaned of loose particles, foreign matter, and any rust, oil, solvent, grease, dust, dirt, or bitumen just prior to patching.

2-818C.3c Removal by Hydro-demolition

Hydro-demolition usually is employed if the total surface area of the bridge deck is to be replaced. Hydro-demolition removal can be used for selective patches instead of removal by pneumatic hammer.

At least two weeks prior to the planned initiation of hydro-demolition operations, the contractor must submit to the Inspector for approval a comprehensive plan for the containment, filtration and disposal of hydro-demolition runoff water and concrete debris. The plan must ensure that all concrete debris will be removed from hydro-demolition runoff water prior to its release to the environment.

All hydro-demolition equipment should be capable of selectively removing spalled, delaminated, or otherwise deteriorated concrete and cleaning the existing reinforcing steel of all rust and corrosion products by use of high-velocity water jets acting under continuous automatic control.

The depth of concrete removal must be at least ¾ in. (19 mm) below the top reinforcing mat but may be such as to include all spalled, delaminated, or otherwise deteriorated concrete. The Inspector may require that a test area be used by the contractor to establish the depth of concrete removal and the desired hydro-demolition machine settings. The Inspector will be the sole determiner of what constitutes deteriorated concrete, using sounding methods or other evaluation measures at his discretion.

All loose concrete debris must be removed within one hour following the initiation of hydro-demolition in a patch area. Debris removal is followed by flushing the existing concrete bonding surface with water to completely remove all traces of concrete debris and cement residue that may prevent bonding. Rebonding of new concrete to the surface of the remaining sound concrete will be enhanced by the use of an approved bonding compound. If it is not convenient to clean and flush the patch area within one hour, all steel reinforcement and concrete bonding surfaces will be cleaned subsequently by high-pressure water blasting

at a nozzle pressure not less than 7000 psi (48,000 kPa) with a volume sufficient to completely remove all rebonded debris and laitance.

All deteriorated concrete is removed by hydro-demolition methods, except that pneumatic hammers may be used, if approved by the Inspector, in the following cases:

- small areas within larger areas designated for hydro-demolition that are not accessible to hydro-demolition equipment
- the removal of any remaining thin concrete ridges or “shadows” directly beneath reinforcing bars
- if necessary to achieve required clearance around lap splices in the repair of deteriorated or damaged reinforcing steel

The weight of the pneumatic hammers may not exceed 30 lbs. (14 kg) for concrete removal above the top reinforcing steel and 15 lbs. (7 kg) for concrete removal below the top reinforcing steel. If pneumatic hammers are used, the minimum depth of removal will be not more than 1 in. (25 mm) shallower than any adjacent hydro-demolished deck excavation.

If the existing reinforcing steel is damaged or corroded, it must be cut out and replaced with new reinforcing steel of the same size. Sound reinforcing steel damaged during concrete removal must be repaired or replaced by the contractor at his expense, as directed by the Inspector. New steel will be attached beneath or beside existing steel with a minimum splice length as indicated on the plans or as directed by the Engineer. The concrete will be removed to a minimum depth of $\frac{3}{4}$ in. (19 mm) below the new steel.

2-818C.4 Patching

The patch product and mix are indicated in the special provisions. Products that may be specified are:

- Class F concrete
- latex modified concrete
- gypsum Portland cement

Mixing and placing concrete should be prohibited unless the ambient temperature is greater than 35°F (2°C) and rising. All mixing must be accomplished by means of a standard drum-type portable mixer. A continuous-type mobile mixer may be used if permitted by the Engineer. The total mix must be limited to the quantity that can be mixed and placed in 15 minutes.

The Inspector should not allow the contractor to patch any more than can set up by the time normal traffic patterns must be restored. The contractor may not remove more deck material than can be replaced by the time normal traffic patterns must be restored. Use of steel deck plates to cover unrepaired areas prior to making the patch is not allowed by the Department.

2-818C.4a Preparations

The concrete surface and reinforcing steel to receive patching material is blast-cleaned followed by air-blasting to remove all loose particles and dust. All blasting operations are performed using techniques approved by the Engineer, taking care to protect all pedestrians, traffic, and adjacent property. The concrete surface to be patched is dampened, and all free water must be removed.

If less than one-half of the surface area of the reinforcement is exposed after removal of deteriorated concrete, the reinforcement is coated with an approved epoxy bonding compound. The epoxy bonding compound is mixed and applied in strict accordance with the manufacturer's instructions. The steel surface

is sandblasted and must be absolutely dry. Promptly after mixing, a single coat of epoxy material is applied to the partially exposed reinforcement, with minimum coverage of 20 mils thickness.

The Inspector will observe the underside of the bridge deck for pop-outs caused by the removal of deteriorated concrete. The surface area of pop-outs must be coated with epoxy resin if ordered by the Inspector. The concrete surface and exposed reinforcing steel, if any, that is to receive the coating material must be cleaned of all loose or powder-like rust, oil, dust, dirt, loose particles, and other bond-inhibiting matter just prior to coating for delamination.

2-818C.4b Spreading and Finishing

The concrete mix is spread evenly and compacted to a level slightly above the pavement surface. Vibration must be used to thoroughly consolidate the concrete and fill the entire patch area. If practicable, internal vibration is used if concrete is removed below the reinforcing steel. Hand tamping can be used to consolidate concrete in smaller patches, including pop-outs.

It is preferred that vibrating screeds be used for strike-off and consolidation. After the mix is placed and compacted, the vibrating screed is drawn over the surface. It must move at a uniform speed without stopping to finish the surface smooth and even with the adjacent concrete. The surface is float finished. Mixes requiring fast-setting gypsum Portland cement set in a short time. All of the finishing operations must take place before initial set.

2-818C.4c Testing

The Inspector will make test cylinders. The dimensions, type of cylinder mold and number of cylinders is standard but may be increased by the Engineer under some circumstances.

2-818C.4d Unacceptable Work

The finished surface profile should not vary more than 1/8 inch in 10 feet (3 mm in 3 m) in any direction. High areas must be ground. Sags require removal of the concrete to a depth of 3/4 in. (19 mm) and repatching. Curing of the patched areas must be in accordance with the Specifications.

Cured patches that have a hollow sound when chain-dragged or tapped (indicating delamination) will be replaced by the contractor at the contractor's expense.

2-818C.4e Opening To Traffic

Traffic is not allowed on any areas where the contractor has placed and finished concrete until the material has reached a minimum of 1800 psi (12,500 kPa). It is anticipated that this will occur in 2 to 3 days for Portland cement and 1½ to 3 hours for gypsum cement mixes.

2-818C.5 Waterproofing Membrane

Installation of waterproofing membrane is covered under Article 7.07 of the *Standard Specifications*. In addition, the manufacturer's recommendations must be followed.

There are various types of membrane waterproofing. Some of the most frequently used products are:

- woven glass fabric
- Royston Bridge Membrane No. 10A (membrane waterproofing)
- Protecto Wrap M-400A (membrane waterproofing)
- heavy-duty bituthene (membrane waterproofing)

Design generally will specify woven glass fabric if the bridge deck is on a grade or adjacent to an intersection where vehicles will be braking or making turning movements. If a contractor requests a material substitution for this item, the Inspector must first check with the bridge designer prior to granting approval. The primers for all products must be diluted with acceptable solvents.

2-818C.6 Placement of Bituminous Concrete Wearing Surface

Application of the paved wearing surface is subject to the requirements for bituminous concrete paving, found in Volume 2, Chapter 6, "Bituminous Pavements". A fine mix (SF) is used, and care must be taken that the membrane is not punctured or damaged in any way during placement of the wearing surface.

2-818C.7 Bridge Deck Joints

There are numerous types of bridge deck joints. The repair procedures for the joints on all bridge projects are detailed in the contract documents. In many cases, the design may require the replacement of the existing type of joint with a superior type of joint. A contractor may request a substitution for the type of joint specified. The bridge designer must approve all substitutions.

2-818D Structural Steel Inspection

Some of the more common defects and repairs involve the following:

- corrosion
- cracking
- fire damage
- collision damage

Structural steel repairs vary according to the location of deterioration, type of structure, element being repaired, and extent of deterioration. Repairs may include reinforcement of existing members, temporary support of existing members, limitation of load, replacement of members, and stress relief in members. The requirements for each type of repair are detailed in the contract documents.

As with other structural members, an in-depth inspection must first be conducted to review the repairs shown on the plans for strengthening structural steel beams and girders. The following must be evaluated:

- extent and location of damage
- extent and location of repairs
- presence of cracking
- limits of collision or fire damage
- fatigue stress damage
- remaining structural capacity

Steel-strengthening construction must include environmental considerations, as well.

The existence of fracture-critical members requires the Inspector to closely scrutinize the condition of each member and to fully understand and comply with the sequence of construction. In addition to specific defects, the Inspector must consider such information as material, age, capacity, and loading. Each of these affects the economics involved in deciding whether to repair or replace a member.

Inspectors should be aware that the proposed repairs are based on the findings of a condition survey of the structure that was conducted prior to the start of design. The survey may have been conducted several years ago. The survey may not accurately detail all parts of the structure that need to be repaired. The Inspector must be alert for differing conditions that may require changing the repair methods, materials, or limits.

2-818E Jacking

Jacking of structural steel beams and concrete substructures is necessary if temporary support of an element is needed to make repairs. Jacking usually serves to remove the loads from the permanent members. Typically, temporary jacking members are stressed higher than permanent bridge structural members. This is done because the loads are for a short duration. Thus, it is crucial that the members be sized, fabricated, and erected exactly according to the plans.

2-818E.1 Jacks and Beams

Jacks with a higher capacity than those listed in the plans may be allowed, but the contractor is responsible for monitoring the jack load to ensure the safety of the structure. The jack system must be equipped with a gauge to directly read the jack force in pounds or kips (newtons or kilonewtons) or shall be accompanied by a chart with which the dial reading can be converted into pounds (newtons). Direct reading gauges are preferred.

The contractor may use alternative jacking beams to those specified on the plans. The alternatives must be approved by the Engineer. The alternative beams must comply with the following restrictions:

- They must be in new condition.
- The section modulus and web area must be equal to or greater than those of the jacking beams shown on the plans.
- If the connection detail or the stiffener-plate details are changed, the contractor will submit detailed calculations to the Engineer for approval. These calculations will be stamped by an engineer licensed in Connecticut.

Jacking beams must be set level, unless indicated otherwise on the plans. In no instance will the contractor be allowed to chip away the concrete end diaphragms to achieve a level jacking beam.

Areas under the jacks should be thoroughly cleaned to provide a flat, clean jacking surface. Jacking surfaces that are not level or have slightly deteriorated concrete areas will be repaired to a flat, level surface with cast-in-place concrete, as specified in the contract. Test cylinders are required for the concrete mix used for bearing pedestal repairs. The existing beams will not be lowered in place until the concrete achieves 3000 psi (21 MPa) minimum strength.

2-818E.2 Welding and Repairs

All field welding is done by the shielded metal arc process. All requirements of the specifications must be adhered to, except that the requirements for radiographic and ultrasonic inspection will be waived if a visual inspection by the Inspector indicates that the welds are satisfactory. The exception applies only to structural steel that is erected for a temporary installation.

If necessary, cast-in-place concrete repairs are used to restore the jack locations to full capacity prior to the jacking. If deteriorated concrete extends on both sides of the beam that requires jacking, one side will be repaired completely before the repair to the other side is started. Both sides must be repaired before the beam can be jacked. The contractor will wait a minimum of 72 hours and until the repaired concrete obtains a minimum compressive strength of 3000 psi (21 MPa) before the jacking operation begins.

2-818E.3 Operations

The Inspector must check all pertinent dimensions and requirements, as set forth on the plans, to ensure that all pertinent stipulations are met before commencement of the actual jacking. The Inspector must be present during all jacking operations. Jacking assemblies, frames and grillages must be inspected daily

while in service. All members, connections, foundations, footings, bracing, and jacks must be inspected for alignment, orientation, and trueness. Frequently, elevations and survey measurements are required to monitor the structure for movement.

An existing bearing may not be raised more than 1/8 in. (3 mm) higher than its as-built elevation, unless otherwise indicated on the plans. The maximum jacking forces shown on the plans will not be exceeded. The jack hydraulics may not be used to support the load after jacking. However, the contractor has the option of using a jack with a locking nut or cribbing blocks instead of the support scheme indicated on the plans.

It is the contractor's sole responsibility to use the correct scheme and jack capacity corresponding to the particular bearing being repaired. Damage of the existing structure resulting from the contractor's misuse of the jacking scheme must be repaired by the contractor to the complete satisfaction of the Engineer, at the contractor's expense.

Any existing bearing assemblies that will be reused, areas of paint that are damaged, and any new steel that, according to the plans, remains in place must be sandblasted in accordance with SSPC-SP10 and painted.

2-818F Repair of Cover Plate Welds

Cover plates are added to the bottom flanges of rolled beams to strengthen the members. Generally, cover plates are welded to the flange, but they may be riveted or bolted. The critical inspection area on a welded cover-plated beam is located at the end of the cover plate where the weld is transverse to the length of the beam. If the weld is not transverse to the bottom flange, it may end near the end of the cover plate. The Inspector must investigate these areas for cracking.

The contractor cleans the welds at the ends of beam cover plates, as indicated on the plans. Surfaces to be cleaned must be blast cleaned in strict conformance with provisions of SSPC-SP10 to "Near White". After the welds are cleaned, the designer and Inspector conduct an inspection. They decide which locations will be peened and which locations will be repaired. Repairs are completed in accordance with the plans.

Cover plate welds are peened to the limits shown on the plans. Peening is performed using a pneumatic hammer and is continued until the weld toe becomes smooth. The depth of indentation due to peening must be approximately 1/32 to 1/16 in. (1 to 3 mm). The Inspector will direct the contractor to peen a test area to demonstrate his methods and results. Areas repaired by peening are painted in accordance with specifications contained in the contract documents.

If a crack is observed, a bolted repair is made as shown in the contract documents.

If any defect is observed by the Inspector, but is not specified for repairs on the plans, the Engineer should be notified immediately.

2-818G Inspection of Structural Steel Cross Section

The failures at expansion joints on bridge decks are caused by deterioration and section loss to bridge girders from the chlorides used for snow and ice control. Some of the affected areas are at the bearings, ends of the girders, and behind the end diaphragms.

If the Inspector suspects that there is section loss, the Inspector must contact the Project Engineer, who requests Bridge Safety to provide a D-meter. The D-meter determines the thickness of the structural members. After determining the thickness of the members, the information is sent to Design to determine if a repair is necessary. Design provides corrective repair plans and procedures to the Assistant District Engineer. The Inspector ensures that both the Engineer's procedures and Article 6.03.03 of the *Standard Specifications* are followed.

2-818H Heat Straightening Structural Members

If a structural member is injured through neglect by the contractor, the Inspector should request a repair procedure from the contractor. The procedure is sent to Design for review and approval. Design provides the approved methods to the Assistant District Engineer.

Heat straightening is a unique method that is used with jacking, blocking, and supplemental supports to correct member misalignment caused by impact. Not all damaged members can be heat straightened. Some members cannot be straightened due to the extent of damage. For others, heat straightening may cause additional damage to the member, reducing member capacity. A member can be heat straightened only once at any one location on the member.

Generally, a member is considered adequately straightened if it is returned to line, grade, and shape within $\frac{1}{2}$ in. (13 mm). Temporary support must be provided for beams while they are being heat straightened. The Inspector will be satisfied that the repair work is implemented correctly by using the submitted and approved procedures and Article 6.03.03 of the Standard Specifications. The Inspector should be familiar with the special provisions, as heat straightening is a specialty repair, with explicit procedures and details.

2-818I Removal of Existing Bridge Decks

Removing existing bridge decks consists of removing and disposing of all materials above the top of the stringers for the width and length of the bridge superstructure. The work is performed in accordance with specifications or as ordered by the Engineer.

2-818I.1 Protective Shields

Prior to any work on the structure, the Inspector should become familiar with the special provisions and plans to determine if protective shields are necessary. If work is to be performed above traveled ways, railroads and water, the contractor is required to provide protective shields to prevent any dust, debris, concrete, form work, paint, or tools from falling onto the area below the structure or onto adjacent traffic lanes.

If protective shields are necessary, the contractor is required to submit the details of the protective shields, consisting of design calculations and working drawings, signed and sealed by an engineer who is licensed in Connecticut. The material is given to the Project engineer, who will review and approved the details only as to the methods of erection and as to whether the proposed installations provide the levels of protection required at the various locations.

If the existing structural steel will be used in the finished structure and the contractor elects to support the protective shields from the steel, all connections must be made by means of clamps or other approved devices. Drilling holes in the existing steel work or welding to the steel work for this purpose is prohibited.

2-818I.2 Operations

Before removal operations begin, the outlines of the top flanges or cover plates of all stringers and floor beams are drawn on the bridge deck, and 1 in. (25 mm) diameter pilot holes are made outside the lines to confirm the location of the steel.

Prior to removing the existing slabs, the contractor must take elevations at locations along the bottom of the bottom flange or top of the top flange by removing small sections of slabs over the stringers. Pilot holes are used at mid-span, quarter points of all stringers, and other points if necessary. Maximum spacing of the elevations is 25 ft. (7.5 m). After removing the deck, the contractor must take a new set of elevations at the same points and determine the superstructure rebound. The rebound values are used, instead of dead-load

deflections, to establish grade controls and the finished top of the concrete deck that is true to planned line and grade. For bridge decks constructed with a longitudinal construction joint between stringers, diaphragms between the stringers may not be disconnected unless specified in the contract documents.

On continuous bridges, the contractor's proposed sequence of deck removal should address uplift at the ends of continuous spans.

If damage results from the contractor's operations, the removal operation must be modified, and the damaged items must be repaired or replaced by the contractor in a manner acceptable to the Engineer at the contractor's expense.

2-818J Substructure Repairs

Generally, the Inspector will encounter only concrete repairs to bridge substructures. In the rare case that a structure is constructed with steel substructure elements, inspection of repairs is performed in the same manner as inspection of structural steel strengthening.

Several materials are currently available for concrete substructure repairs. These include:

- cement-based mortar or concrete
- nonshrink quick-setting mortar
- epoxy mortar
- resin-based polymer concrete
- cement-based polymer concrete
- pneumatically applied mortar

Factors to be considered in selecting concrete repair materials include:

- size
- location
- general function of the member
- portions to be repaired

Material selection is influenced by:

- compatibility of the material with the existing concrete
- environmental considerations, including aesthetics
- cost effectiveness
- expected service life
- availability of the material
- familiarity of contractors with the material

2-818K Deteriorated Concrete Removal

It is important that the Inspector accurately and completely define the limits and extent of concrete to be removed. The limits and extent of deteriorated concrete removal are very important for two reasons. The first is integrity of the repaired element. The repaired element must work as a monolithic mass, and thus, compatibility of materials is important. The second is the safety of the structure to support dead and live load. If a portion of concrete is removed from an element, it no longer has the same capacity to support load. Even if the concrete is restored, it does not carry the load carried by the corresponding portion of removed concrete prior to deterioration. In any case, the Inspector must work with the designer to maintain structural safety of the concrete substructure during repairs.

If the Inspector determines that there is excessive deterioration of a portion of a substructure element, the Project Engineer should be alerted. The Project Engineer contacts Design to request a structural analysis. It may be detrimental to the safety and integrity of the bridge to remove all of the deteriorated concrete at one time.

The Inspector must limit the extent of removal of concrete from the overhang on the piers, on bridge seats, and especially around bearing pads. If there is extensive removal of concrete in these areas, the Project Engineer must be contacted. The Project Engineer will contact Design to request a structural analysis. It may be necessary to design temporary supports to carry the loads while repairs proceed.

2-818L Repair Materials

Portland cement concrete should be used for patching if possible. If the area to be patched is horizontal, larger than approximately 4 sq. ft. (0.37 m²) and is at least 1 in. (25 mm) deep, Class S concrete should be used. Class S superplasticized concrete currently is the preferred product for surface repairs that are less than 1 in. (25 mm) but limited to Class S aggregate size [3/8 in. (10 mm)] deep. The Inspector should become familiar with the specifications for Class S concrete before the contractor performs any repairs.

2-818M General Repair Requirements

If an existing deteriorated concrete element does not have sufficient concrete cover over the reinforcing steel, the area is repaired and built out to gain additional cover and protection of the reinforcing steel. The build-out may also make placement of the concrete easier.

All concrete patches must be mechanically anchored to the existing concrete either by encasement of existing reinforcement or by using drilled anchoring devices attached to the existing concrete.

2-818N Shotcrete

Shotcrete may be recommended for application, if many various-size repairs are needed and the repairs are on vertical or overhead surfaces. Shotcrete, also known as pneumatically applied mortar, is a specialty product that must be placed and cured correctly. Pneumatically applied mortar must have a minimum 28-day compressive strength of 3500 to 5000 psi (25 to 35 MPa).

2-818N.1 Equipment

All shotcrete equipment must be capable of thoroughly mixing all material used and must be calibrated. The mixer must be self-cleaning and capable of discharging all mixed material without any carry-over from one batch to the next. Mixing equipment must be cleaned at least once a day.

The air compressor should have a capacity sufficient to maintain a supply of clean, dry air adequate to provide the required nozzle velocity for all parts of the work, while simultaneously operating a blow pipe for cleaning away rebound. The air and water pressure must be constant and not pulsate.

2-818N.2 Preparatory Work

The contractor will contain all blast waste and loose concrete and promptly remove it to an approved disposal site. Blast waste and loose concrete must be kept out of waterways.

The deteriorated areas of concrete must be removed to sound concrete with a 30 lb. (14-kg) (maximum) chipping hammer to a minimum depth of 1 in. (25 mm) behind the reinforcement steel.

After the Engineer has determined that the cavity surface is sound, it must be sandblasted. Just prior to mortar application, all surfaces will be thoroughly cleaned, followed by wetting and damp drying.

If sound concrete is encountered before the reinforcement steel is exposed then the sound concrete is removed to a depth of 1 in. (25 mm) behind the existing reinforcement steel. If sound concrete is found within 3 ½ in. (90 mm) of the proposed finished surface, the removal operation stops, and additional No. 4 (No. 13M) reinforcing bars are doweled at 12 in. (300 mm) center to center horizontally and vertically, 2 in. (50 mm) clear of the proposed finished surface. Doweling details are as directed by the Engineer.

All exposed existing reinforcement steel that is incorporated in the new work is sandblasted to a near-white finish to remove all rust, dirt, scale, and loose concrete. All deteriorated reinforcing bars that have lost 20 percent or more of their original dimension must be cut out, and new bars are welded in their place. Dual bars of equivalent or greater section may be used. New reinforcement steel is welded to existing reinforcement steel as specified in the contract documents. The Engineer decides whether reinforcement steel is to be reused or replaced.

All areas to be repaired are reinforced with wire mesh, in addition to the reinforcement steel.

For anchoring reinforcement to masonry surfaces, expansion bolts not less than 3/8 in. (10 mm) in diameter are set into drilled holes, or plain round No. 4 (No. 13M) bars are set in approved dry-packed mortar, tightly driven into drilled holes. Drilled holes should not be less than 3 in. (75 mm) deep. All bolts or bars must be set in solid masonry (not in mortar, joints, or cracks) and must have heads or hooks on their outer ends. If approved by the Engineer, wire-mesh reinforcement can be wired to existing reinforcement without the use of expansion bolts.

2-818N.3 Application

The cement and sand must be uniformly dry-mixed in a batch-mixing machine. Material that has not been applied within one hour after being mixed must be discarded. After the materials are dry-mixed and before being charged into the placing machine, the mixture must be passed through a 3/8 in. (10 mm) screen.

Each layer is built up by several passes of the nozzle over the working area. The mixture must emerge from the nozzle in a steady, uninterrupted flow. If the flow becomes intermittent, it must be directed away from the work until it becomes constant. The nozzle must be held perpendicular to the application surface, at the distance from the surface to get the best results for the conditions. When shooting through reinforcement, the nozzle must be held at a slight angle from perpendicular to permit better encasement.

The application of the mixture to vertical surfaces begins at the bottom. The first layer should, at least, completely embed the reinforcement.

Rebound may not be worked back into the construction, and it must not be salvaged and included in later batches. Rebound and overspray may not be allowed to fall into waterways and will become the property of the contractor, who can dispose of this material at the contractor's own expense in an approved disposal site.

If a layer of pneumatically applied mortar is to be covered by a succeeding layer, it will first be allowed to take its initial set. Then all laitance, loose material, and rebound must be removed by brooming. Laitance that has been allowed to take final set is removed by sandblasting, and the surface is cleaned with an air-water jet. In addition, the surface will be sounded by the Inspector with a hammer for hollow-sounding areas resulting from rebound pockets or lack of bond.

The area of repair on existing structures must be finished to match the existing structure.

2-818O Copolymer Cementitious Mortar

If other methods and materials for patching are not satisfactory, copolymer cementitious mortar should be used. The copolymer should be used for shallow patches; the maximum thickness per layer may not exceed the manufacturer's recommendation. This product has proved somewhat difficult for some contractors, but there are sufficiently satisfactory installations to continue its use.

The minimum mortar thickness should be 1/8 in. (3 mm), and the maximum thickness should be 1 in. (25 mm). The mortar may not be specified for individual patches that exceed approximately 4 sq. ft. (0.4 m²) of surface area.

The contractor should obtain the services of a technical adviser to assist the Engineer and the contractor during the work. The adviser must be a qualified representative of the manufacturer, approved by the Engineer, and at the work site prior to mixing the components.

For all repairs, the specification requirements regarding surface preparation, mix application, and cure must be adhered to for the work to be successfully accomplished.

2-818P Crack Repair by Epoxy Injection

Epoxy injection as a means of repairing cracks will not correct the cause of the cracking. This is because epoxy resins used for injection are, like concrete, generally unable to resist tension forces. Once the cause of the cracking is corrected by other repair means, epoxy injection can rebond the concrete element into a composite member, seal the concrete to preclude moisture penetration, and reduce reinforcing steel corrosion potential.

The Inspector must be careful when injecting an abutment, because if the crack is completely through the abutment, the epoxy may be injected into the soil behind the abutment.

The Inspector, in cooperation with the designer, determines the scope and extent of the epoxy injection contract work. The Inspector must be familiar with the epoxy-injection contract documents and the types of cracks that are designated to be repaired. Injection of all cracks, regardless of crack width, is not necessary. The Inspector must have a clear understanding, developed during an initial structure inspection, of the size and limits of cracks to be injected. After determining the intent of the designer, the Inspector directs the contractor accordingly.

The contractor will not perform any repair work without prior approval of the Inspector as to location, limits, and method of injection. Contractors must be prequalified specifically for epoxy injection.

2-819 Painting

In the last several years, painting of new and existing bridges and structures has become technically complex. Cleaning and painting is no longer simply the removal of the existing coatings, application of primer coats, and application of top coats. Management of blast residue – including containment, transport and disposal – is very important to both the Department and environment.

Recent developments in the protective-coating industry, research, and contractor prequalification programs of the Steel Structures Painting Council (SSPC), as well as proactive, strict environmental rules and regulations, place significant limitations on painting. The developments also provide powerful tools to the Inspector in performing his work.

References available to the Inspector include SSPC-VIS-1 and SSPC “Good Painting Practices,” as well as Article 6.03.03-23 through -38 of the *Standard Specifications*. Volume 2, Chapter 1, “Environmental Protection,” includes general information about waste generated by painting structural steel.

2-819A Preconstruction Requirements

2-89A.1 Debris and Material Storage

Information concerning the surface-preparation debris-storage containers and their storage-site locations must be submitted to the Inspector for review and approval. Storage sites must not present a hazard to traffic and must be located in areas that are properly drained. The storage containers must be in conformance with the specifications. Volume 2, Chapter 1, “Environmental Protection,” includes additional information on debris and material storage.

The contractor must supply the location of the storage facility for the paint for approval by the Engineer. This facility must comply with the latest OSHA regulations, to provide protection from the elements and ensure that the paint is not subjected to temperatures outside the manufacturer's recommended extremes. It is desirable that the storage facility be in proximity to the work site and be accessible to the Inspector at all times. The contractor is fully responsible for storage at all times.

The Inspector will contact the Office of Research and Materials to determine if the manufacturer of the coating system is on the approved supplier and manufacturer list. Prior to beginning any painting, the contractor must provide the Inspector with the manufacturer's technical data sheet and application instructions for the coating system being used.

2-819A.2 Containment System Plan

The contractor will prepare a Cleaning Containment System Plan for the capture, containment, collection and storage of the waste generated by the work. The containment system must be capable of containing blast residue generated by the work.

If required by the contract documents, the contractor will submit plans and details for the recovery system for recycling blast material used for blast cleaning; a written compliance program for worker protection; and an industrial hygienist's plan of action indicating procedures for monitoring air, soil, and water. The action plan will include the type of equipment, approximate location of monitors, and test samples for each bridge site.

Within 14 days after receiving award and prior to beginning work at each bridge, the contractor will submit working drawings of the proposed containment system. The contractor must also submit the design of the systems to be employed, including an analysis of the load that will be added to the existing structure by the containment system and blast waste. The load analysis must be performed and stamped by a licensed engineer having a minimum of five years of experience in bridge design. The analysis will assure that the system will not induce a load on the bridge that will create an overstress condition or otherwise affect the structural integrity of the bridge. The containment system or equipment will not encroach upon the minimum bridge clearances. The Inspector must ensure that the contractor's operations are at all times in conformance with the approved Cleaning Containment System Plan.

2-819A.3 Containment Meeting

Prior to the start of paint removal operations, a meeting will be held with the contractor, painting subcontractor, inspection staff, and District supervisor to review the containment requirements, plans, and monitoring process, as well as the need for strict adherence to the containment and collection requirements. The contractor must prepare a remedial action plan to address the potential of a containment or collection

failure. The Inspector will advise the contractor that noncompliance in this area could result in the painting firm being found in default of the contract.

2-819B Equipment

The contractor should provide the following equipment. The equipment should be new and for the exclusive use of the Engineer to inspect the contractor's cleaning and painting operations.

- *PTC Surface-Temperature Thermometer.* The range should be from 0 to 150 °F (-18 to 66 °C). Use to record the surface temperature of the steel.
- *Psychron 566 Psychrometer.* It should include two sets of batteries. Use to record the relative humidity at the work site.
- *Spring Micrometer for Coatings.* Use to measure Testex tape to determine the surface profile of the steel.
- *Testex Press-O-Film Replica Tape-Extra Coarse (1.5 to 4.5 mils).* One roll (100 pieces) should be provided for each bridge span. Use to measure surface profile after steel is blast cleaned. The extra coarse tape is used as specified. Remove the wax paper from the tape, and place it emulsion side down on the blasted surface. Rub the mylar vigorously with the blunt burnishing tool provided until the mylar turns uniformly gray. Remove the tape, and place it between the anvils of a spring micrometer. The micrometer reading, after subtracting Textex tape thickness, represents the profile.

The following references and equipment can be reviewed at or obtained from the District Office:

- *Respirator.* Each Inspector must be properly fitted and instructed on proper use. The respirator must be worn at all times while on the project during surface cleaning and painting operations.
- *Safety Glasses, Disposable Coveralls, Gloves.*
- *SSPC-VIS 1-89.* This is a book of color prints illustrating the desired surface condition standards for various degrees of abrasive blast cleaning over mill scale and various rust grades of structural steel. It may be desirable to prepare blast test panels for reference throughout the project.
- *Inspection Mirror.* Use to view locations that are not readily accessible to ensure proper cleaning and coating applications.
- *Wet-Film Thickness Gauge.* Use to approximate the amount of coating applied while wet to help ensure that the proper dry-film thickness results. The gauge is placed squarely and firmly on the wet surface immediately after the coating application. Remove the gauge and note the highest step covered by the coating. The wet-film thickness lies between this step and the next uncoated step.
- *Magnetic Pull-Off Dry-Film Thickness Gauge.* Used to obtain nondestructive measurements of non-magnetic coatings applied to a ferrous metal surface. The gauge must be calibrated with metallic shims, provided with the gauge, prior, during and after use. To operate, hold the gauge firmly to the surface, then turn the dial forward until the magnet is in solid contact with the surface to be measured. The dial is slowly and evenly turned back until the magnet breaks contact with the surface. The coating thickness is read as the number on the scale that lines up with the hairline on the instrument.

- *Tooke Gauge.* Use only if specified to measure the dry-film thickness of the coatings, using a 50× microscope in conjunction with a microscopic incision made through the coating. However, this is a destructive test, and any areas where this is used must be repaired. Make a reference benchmark on the coating surface with a felt-tip pen. Then make an incision with one of the cutting tips through the coating down to the substrate at the location of the benchmark. The proper tip must be used, based on the anticipated thickness of the total coating:
 - 10× tip: 0-3 mils coating thickness
 - 2× tip: 3-20 mils coating thickness
 - 1× tip: 20-50 mils coating thickness

View the incision with the microscope. Line up the reticle of the microscope across the incision and count the number of divisions for each coat. The determination of the coating thickness is interpreted as follows: each division is equivalent to 1.0 mil if the 1× tip is used; 0.5 mils if the 2× tip is used; and 0.1 if the 10× tip is used. The thickness reading is the average of readings obtained across the length of the incision.

2-819C Containment Enclosures

Surface-preparation (abrasive blast-cleaning) operations are allowed only within containment enclosures approved by the Inspector. If, during surface preparation, the containment enclosure allows debris to escape, work must be stopped until the enclosure is repaired to the Inspector's satisfaction. Any debris that escapes from the enclosure must be cleaned up by the contractor immediately.

The following apply to the containment requirements on all projects for which paint removal operations are planned:

- All seams on containment enclosures must be lapped a minimum of 2 feet (0.6 meters).
- All seams must be tied off at intervals not to exceed 1 foot (300 mm).
- All attachments to bridge parapets and the undersides of bridge decks must be sealed to prevent the escape of fugitive dust.
- The area between beams beneath the bridge deck must be enclosed with a solid bulkhead and sealed to prevent the escape of fugitive dust.
- All tarpaulins used on containment enclosures must be impervious.

2-819D Air Pressure in Containment Enclosures

SSPC "Guide 6I" and project specifications require the average negative pressure in a containment enclosure to be 0.03 in. (0.8 mm) of water relative to the ambient pressure. The negative pressure is monitored with a magnehelic gauge. A magnehelic gauge consists of a pressure gauge and two flexible tubes. The tubes are placed at two locations, and the gauge measures the difference in pressure between them.

Initial pressure readings are taken when the containment system is complete and all ventilation systems are running. The readings should be verified every five working days. Additional readings should be taken if problems occur and after any changes are made to the containment system. The contractor's dust collectors are equipped with a magnehelic gauge that measures the difference between the dirty and clean sides of the filters. The Inspector should monitor the readings to help identify problems or changes to the system.

To use the gauge, feed one tube to the outside of the containment. Use the other tube to take readings within the enclosure. Visually divide the enclosure into equal volumes, none of which should be larger than 10 x 10 x 12 ft. (3 × 3 × 3.5 m). Stack the volumes for enclosures that are higher than 12 ft. (3.5 m). Take readings at the center of each volume. No reading can be less than the 0.03 in. (0.8 mm) required. Record the readings and calculate the average.

If the results do not meet the specifications, notify the contractor and repeat the readings. Take a minimum of five readings. To meet the specifications, no more than two readings can be below 0.03 in. (0.8 mm), no reading can be 0.00 in (0.0 mm), and the average of the readings must be 0.03 in. (0.8 mm) or greater. If the results are still not acceptable, the contractor must shut down the operation and make corrections. No blasting is allowed until after the corrections are completed.

2-819E Surface Preparation

Surfaces must be prepared as specified in the SSPC specifications, the contract specifications, and Article 6.03.03 of the *Standard Specifications* and as indicated by the results of the sample blast test panels. The cleaning methods are described below.

- Only recyclable blast materials may be used.
- Solvent cleaning is used to remove foreign matter such as oil, grease, soil, and other contaminants from steel or galvanized surfaces. Solvents, emulsions, cleaning compounds, steam cleaning, or similar materials and methods approved by the Engineer are used as specified in SSPC-SP 1, “Solvent Cleaning”. Soap steam cleaning must be used in cleaning steel grids that are open, decks and walkways, and machinery areas of drawbridges. Contaminated solvent must be removed before it evaporates by wiping or rinsing with clean solvents to prevent a film of contaminants from remaining on the surface.
- Hand-tool cleaning is used to remove loose mill scale, loose rust, and loose paint from steel surfaces. Non-mechanical brushing, sanding, chipping, scraping, or other hand-impact methods conforming to SSPC-SP 2, “Hand Tool Cleaning” must be used.
- Brush-off blast or power-tool cleaning conforming to SSPC-SP 7, “Brush-Off Blast Cleaning,” is used to remove loose mill scale, loose rust, and loose paint from steel surfaces. Power wire brushes, impact tools, grinders, sanders, or any combination of these tools must conform to SSPC-SP 3, “Power Tool Cleaning,” and must be approved.
- Abrasive blast cleaning is used to remove mill scale, rust, rust scale, paint or other foreign matter from steel surfaces. Sand or steel grit abrasive propelled through nozzles or centrifugal wheels producing a surface conforming to SSPC-SP 10, “Near-White Blast Cleaning” must be used only after approval. The end surface condition must conform to near white. Abrasives should be dry and free of oils, grease and other harmful materials, such as lead dust, at the time of use.

Regardless of the method used for cleaning, the contractor will comply with the specifications and the manufacturer's recommendations. As a minimum, the contractor should feather the edges of remaining old paint so that the repainted surface has a reasonably smooth appearance. Heavy rust and pack rust must be removed by a combination of cleaning procedures, such as hand chipping (using chipping hammers or scaling hammers), brush-off blast cleaning, power tool cleaning, etc., without scarring the steel. Oil and grease must be removed by solvent cleaning. Prior to blast cleaning, all surfaces are washed with a pressure washer capable of 2000 psi (13.8 MPa) maximum pressure at the nozzle using potable water to remove

dust, dirt, debris, and salt contaminants. Paint removed during washing operations must be contained and collected.

The minimum height of the steel-surface profile after cleaning is 2 to 3 mils and should be uniform. The Inspector must verify the profile height with Testex Replica Tape, extra-coarse. The used tape is included with the project records.

2-819F Waste Disposal

At the end of each work day, the contractor must haul the waste material away from the bridge site to the approved temporary storage site. The storage site must be capable of preventing the migration of the lead-contaminated abrasive into the environment. The storage area must provide protection from vandalism and unauthorized access by the general public. The waste may not remain at the temporary storage site longer than 90 days.

The testing of the surface preparation debris for classification as “contaminated” or “hazardous” and the disposal of it will be in accordance with the contract requirements. The Inspector must ensure that material that tests as hazardous is transported to a proper disposal site and that the necessary documentation is provided to assure proper disposal. The Inspector should require a signed manifest to ensure that the material has been delivered. Additional information about the procedures for hazardous-waste disposal is in Volume 2, Chapter 1, “Environmental Protection”.

The Environmental Compliance Unit or DEP may be contacted to answer questions, to provide assistance, and to obtain details on the proper handling, storage, containment, and transportation of hazardous materials.

2-819G Coatings Inspection

Coating system product sampling, testing and approval must be in accordance with the contract requirements. The Inspector should have all relevant technical data sheets (TDSs) and may require the contractor to schedule a meeting with the technical adviser employed by the coating manufacturer to establish the correct application for the materials being used.

2-819H Materials

Thin skins formed in a paint container must be cut loose and discarded. Material that is livered, gelled, thick skinned, or questionable may not be used unless reapproved by the Inspector. Waste chemical solutions, oil rags and other waste must be removed daily. All necessary precautionary measures must be taken to ensure that workers and work areas are adequately protected from fire hazards and health hazards resulting from handling, mixing, and application of materials. Materials may not be used beyond their pot life. The Inspector should refer to the TDS for the materials being used.

2-819I Weather

Paint may not be applied if the ambient air temperature is below 40 °F (5 °C), the air is misty, or conditions are otherwise unsatisfactory for the work. The relative humidity should be below 85 percent. The paint must not be applied to damp or frozen surfaces. Paint operations may be stopped by the Inspector during winds up to 20 mph (32 km/h). Paint operations will stop if the wind velocity exceeds 20 mph (32 km/h) unless otherwise approved by the Inspector. The Inspector should refer to the TDS for other conditions that may apply to the material.

2-819J General Requirements

The contractor will schedule operations so that all cleaned surfaces are painted immediately, not to exceed 24 hours after cleaning. If rust bloom appears or the air or steel temperature falls below 5°F (2.5°C) above the dew point after cleaning and prior to application of the primer coat, the contractor must re-clean the affected areas to the satisfaction of the Inspector.

If it is suspected that moisture is condensing on the surface, a well-defined area of the surface may be lightly moistened with a damp cloth and observed. If the dampness evaporates and decreases in 15 minutes, the surface is considered satisfactory for the application of paint. If fresh paint is damaged by the elements, the paint must be replaced or repaired by the contractor at no additional cost to the Department.

The contractor may begin painting operations after the Inspector has reviewed and approved the cleaned surfaces. All surfaces to be painted will be sound, properly cleaned, and thoroughly dry. The Inspector will review the proficiency of the applicator prior to beginning the full-scale painting operation. A test panel may be prepared as required by the Inspector.

2-819K Coating New Steel

The primer coat is applied in the shop as recommended by the manufacturer in a single application employing multiple-spray passes. The specified coating film thickness must be applied to all surfaces to be painted, except a light dust coating is applied to the areas of field welding and to the top and both edges of the top flange where steel stud shear developers are attached.

Except for shop coat touch-ups, steel that will be exposed to view in the completed structure must not be painted until all concrete has been placed. The contractor must protect concrete from being stained by painting operations. Damaged concrete surfaces must be restored to the originally intended color without damage to the concrete.

Bolts for field assembly may not be shop coated. After field welding and prior to applying the intermediate or tie coat, these bolts, field weld areas, and rusted or damaged areas will be brush-off blast or power-tool cleaned or abrasive-blast cleaned if required. The primer coat must be applied on these areas the same day that they are cleaned. Primer paint stained from rusted bolts is wiped before the following coats are applied.

The primer is applied from agitated containers. All touch-ups must have the same dry-film thickness as the coat being repaired but may be applied by brush. Organic zinc primer may be used to touch up the primer coat.

2-819L Coating Existing Steel

All paint must be properly mixed and applied as specified by the manufacturer, except that all painting is applied by brush unless otherwise approved by the Inspector. Roller application may be used on the finish coat. Spray painting is permitted provided the location and method of application has been approved by the Inspector. However, all areas adjacent to machinery or mechanical components, etc., are painted by brush application only. All dry spray and runs must be removed prior to the application of the succeeding coat. Surfaces inaccessible for painting by regular means will have the paint applied by sheepskin daubers or by other means necessary to ensure coverage at the proper coating thickness. Thinning of paint is prohibited.

The Inspector notifies the Bridge Safety and Evaluation Section, Office of Engineering, in writing of any cracks or section loss that have been detected during the cleaning operation. The Structural Deficiency Report form, shown in Figure 2-8.14, is used for the notification. The Inspector must ensure that all foreign materials loosened by the blast cleaning are completely removed prior to the painting operations.

The steel will be kept dust free during painting operations, and care must be taken to protect newly coated surfaces from cleaning operations. If an area that was cleaned or painted becomes soiled, contaminated or rusted, the area is re-cleaned to the specified condition and completely recoated at no additional cost to the Department.

2-819M Defective Work

The contractor is responsible for the satisfactory application of paint. During the contract warranty period, paint must be removed, and the steel must be thoroughly cleaned and repainted at no additional cost to the Department under any of the following conditions:

- rusting occurs
- any paint coat lifts, blisters or wrinkles
- any paint coat shows evidence of having been applied under unfavorable conditions
- the workmanship is poor
- impure or unauthorized paint is used

The painting may be deemed unsatisfactory for other reasons, as well.

2-819N Stenciling

When the final coat of paint is dry, the contractor stencils a legend on the structure indicating the type of paint used in each coat and the month and year in which each application was completed. The stencil must be applied with black paint inside a fascia stringer near the abutment at a location selected by the Inspector.

2-819O Paint Storage

The inspector must be familiar with and the contractor must adhere to the coating manufacturer's recommendations for storage. Paints and thinners will be stored in well-ventilated areas and not subject to excessive heat, open flames, electrical discharge, or direct sunlight. Materials susceptible to damage by low temperatures must be stored in heated areas if necessary. All materials will be used on a rotating stock basis and remain closed until used. Paints that cannot be stirred to attain normal consistency may not be used. Paints that are not in actual use will be stored in tightly covered containers at not less than an ambient temperature of 45 °F (7 °C). Containers used for storage of coatings must be maintained in a clean condition, free of foreign materials and residue.

2-819P Health and Safety

The Department has initiated special contract requirements for the implementation of a Lead Health Protection Program (LHPP) where work tasks pose a serious airborne lead exposure risk. The contract requirements for each project must be thoroughly understood and complied with. All Inspectors assigned to painting projects, who will be subjected to the airborne lead exposure risks, are required to participate in the LHPP specified in the contract.

The Department has an agreement with the U.S. Department of Labor's Occupational Safety and Health Administration (OSHA) to assist the Department with compliance with federal lead regulations to prevent excessive employee exposure to lead.

2-819Q Reporting

Inspectors on painting projects will make out Daily Work Reports (DWRs) and the following special reports:

- *Structural Deficiency Report.* It is shown in Figure 2-8.14. Structural deficiencies noted during the inspection of the work, not included in the scope of the contract requirements, are reported by phone to the Bridge Safety and Evaluation Section and then followed with the formal submission of a completed Deficiency Report.
- *Daily Containment Inspection Report.* See Figures 2-8.15a and b. The report is completed each day and at each bridge site where the contractor is performing surface preparation. The Inspector covering the cleaning operations prepares the form and attaches it to the daily IR. In addition, the Project Engineer should both review the painting operations at least two times per month to verify compliance and use the form to prepare a report on the findings. The District Environmental Coordinator, whenever visiting a project with an active painting operation, reviews the operation and prepares a report using the form. The Project Engineer and District Records Examiner, when reviewing the project records, monitor the form's completion and use.
- *Daily Bridge Painting Quality Control Inspection Report.* The Report is shown in Figure 2-8.16. The report is completed daily as a supplement to the Inspector's Daily Report.
- *Bridge Paint Inspection Checklist.* The Report is shown in Figures 2-8.17a and b. The report is completed daily as a supplement to the Inspector's Daily Work Report.

Figure 2-8.14 Structural Deficiency Report

Structural Deficiency Report

Location: _____

Bridge Number: _____

Span: _____

Girder / Beam / Diaphragm affected (circle one)

Problem and Location: _____

Prepared By: _____ Date: _____

Figure 2-8.15a Daily Containment Inspection Report

Daily Containment Inspection Report			
Town: _____	Date: _____		
Project No.: _____	Weather: _____		
Painting Contractor/Subcontractor: _____	Temperature: _____		
Bridge Number: _____	Wind Condition: _____		
Bridge Location: _____	None	Light (0-16)	_____
Specified Containment Level: _____	Moderate (16-32)	Strong (>32)	_____
Crossing Feature:	Secondary Roadway	Expressway	_____
	Wetland	Watercourse	_____
Containment Parameters			
	Yes	No	
Containment Plans Approved	_____	_____	Date _____
Impervious Tarps	_____	_____	
Seam Lap	_____	_____	
300 mm Max. Tie-offs	_____	_____	
Bulkheads Between Beams	_____	_____	
Parapet Attachment			
Continuously Sealed	_____	_____	
Impervious floor/deck	_____	_____	
Holes in Containment	_____	_____	
Sealed Entryway	_____	Airlock _____	Overlap _____ Open Seam _____
Support Type	Rigid _____	Cable _____	Other (describe) _____
Ventilation	Visual _____	Measured _____	Pressure Differential _____
Exhaust Dust Filtration	Manufacturer _____	Model _____	
Visual Emissions	None	<10 min/day	_____
	10-15 min/day	>15 min/day	_____

Figure 2-8.16 Daily Bridge Painting Quality Control Inspection Report

**Daily Bridge Painting Quality Control
Inspection Report**

Date: _____ Project No.: _____ Bridge No.: _____
Location of Work: _____
Time Started: _____ Time Completed: _____
Contractor: _____ Inspector: _____

Method of Verification
Ambient Conditions and Time Taken

Dry Bulb: _____
Wet Bulb: _____
Relative Humidity: _____ Dew Point: _____
Surface Temperature: _____

Surface Preparation

Degree of Cleaning Sepcified: _____
Degree of Cleaning Achieved: _____
Method: _____
Type of Abrasive: _____
Coating Materials: _____
Batch No.: _____ Mfg. Date: _____ Shelf Life: _____
Thinner Type: _____ Amount: _____
Application: _____ Type of Equipment: _____
Wet Film Thickness: _____
Location of Reading: _____
Dry Film Thickness: _____
Location of Reading: _____

Hazardous/Contaminated Debris

Drums/Containers: _____ Labeled: Yes _____ No _____
Comment: _____

Figure 2-8.17a Bridge Paint Inspection Checklist

Bridge Paint Inspection Checklist			
Date: _____		Inspector: _____	
Bridge No.: _____			
1. Specified Coating System:	<u>Coating Manufacturer</u>	<u>Supplied Material</u>	<u>Specified D. F. T.</u>
Primer (i.e. Organic Zinc) _____	_____	_____	_____
Intermediate (i.e. Epoxy Mastic) _____	_____	_____	_____
Finish (i.e. Aliphatic Urethane) _____	_____	_____	_____
2. Required Reference Material at the site, 1 copy each: Coating Manufacturer's Product Data Sheet Bridge Paint Specification Surface Preparation Specification			
3. Environmental Conditions: To be obtained a minimum of every three (3) hours. When a reading is close to the minimum or maximum specified condition, then readings must be obtained every twenty minutes until that particular condition improves or fails.			
	<u>Specified</u>	<u>Actual</u>	
Air Temperature	_____	_____	
Steel Surface Temperature	_____	_____	
Coating Material Temperature	_____	_____	
Dry Bulb Thermometer Temp	_____	_____	
Wet Bulb Thermometer Temp	_____	_____	
Relative Humidity	_____	_____	
Dew Point	_____	_____	
4. Surface Preparation: Cleaning Specified (i.e. SSPC-SP-10): _____			
Adjacent Surfaces Protected: Yes _____ No _____			
Containment Enclosure: Yes _____ No _____			
Cleaning Achieved: _____			
If blast cleaning, type of abrasive used and size: _____			
Dust and residue removed prior to coating application: Yes _____ No _____			
			Page 1

Figure 2-8.17b Bridge Paint Inspection Checklist (continued)

Bridge Paint Inspection Checklist

5. Application: Method Utilized (Spray, Brush, Roller): _____

Volatile Organic Compounds (V.O.C.) Content as supplied: _____ kg/L

If thinned, how much thinner in liters of thinner per liter of paint? _____

V.O.C. Content after thinning: _____ kg/L

Note: Coating Manufacturers Technical Service Department can assist.
V.O.C. content is determined by ASTM D3960.

Wet Film Thickness = W.F.T. 1 μm = 0.000 001 m
 Dry Film Thickness = D.F.T.
 Percent of Solids by Volume of Coating = V.S. (i.e. 53% = 0.53)
 Volume percent of thinner added = T (i.e. 0.25 liters per 4 liters = 0.25/4 = 0.0625)

$$\text{Required W.F.T.} = \frac{\text{Specified D.F.T.} (1.0 + T)}{V.S.}$$

$$\text{Sample: } 150 \mu\text{m} = \frac{75 \mu\text{m} (1.0 + 0.0625)}{0.53}$$

Coating Induction Time if required: _____

Time between coats: _____

Primed before rust back: Yes _____ No _____

6. Semi-Final Inspection:

Coating System D.F.T.: Specified _____ Actual _____

Defects for Correction—Low D.F.T., Sags, Runs, Splatters: _____

Corrective Action: _____

7. Final Inspection: Review Checklist
 Visual Inspection
 Acceptance/Rejection

Page 2

Chapter 9 - Construction Traffic

2-901 General

This chapter covers control and safety related to construction traffic. It includes information about public relations, specifications, detours, construction signs, channelizing devices, trafficpersons, etc. It does not cover permanent traffic control, such as placing new signs or signals, and does not cover general work safety, such as incident reporting or the use of personal safety equipment. Incident reporting is covered in Volume 1, Chapter 14, "Project Incidents and Complaints". Personal safety is covered throughout the Manual. The Manual does not currently include the construction or installation of permanent traffic controls.

2-902 Public Relations

2-902A Press Releases

The Department must make every effort to keep the traveling public aware of the infrastructure program and inform them of lane and road closures, detours, etc., well in advance of planned activities. The Department informs the public through press releases distributed through the media.

The Department prepares a press release at the beginning of a project and at least one week prior to any significant traffic change, such as a major stage shift. Contract specifications generally require that a Contractor provide a minimum of seven days notice for major changes to traffic operations, such as lane or road closures, traffic shifts, detours, etc. The Chief Inspector informs the Project Engineer of significant traffic changes.

The press release includes the location of the project, project cost, a brief description of the work and how it will affect the traveling public. It should include the duration the roadway will be affected, as well as any pertinent information that may help alleviate possible delays. If the media should be notified, the preparation of the press release should become a top priority of the project staff. If a detour is involved, the Project Engineer should provide sketches of it. The Project Engineer sends the press release to the Manager of Construction Operations such that it is received at least one week before the planned activity.

If the project cannot provide written notification seven days prior to the event, District supervisory personnel should telephone the Office of Construction with an explanation of the circumstances.

2-903 Highway and Underbridge Illumination

All projects should be reviewed for highway illumination prior to any work. The illumination should be inspected with a representative from DOT Maintenance Electrical, the Contractor, including the subcontractor, and project staff. The illumination should be inspected for location and confirmation of the main junction box for the primary power source, address the overall condition of the existing system.

Contract documents and plans should be crossed checked to ensure the highway and underbridge illumination is addressed. Work may have to be performed on the system throughout the course of the project to address possible temporary relocation of existing poles or installation of temporary poles and power to accommodate staging sequences or for the final installation of a proposed system as noted on the project plans. In accordance with the Standard Specifications once the contractor starts to work on a system the overall responsibility for the system will be transferred from the Department to the contractor. This means the Contractor must provide a 24 hour emergency number and respond to any incidents with the system in a work shift.

If a new system is called for there should be an inspection when complete and in the final configuration by Department personnel, including the designer and maintenance. Once the punch list is taken care of the 30 day test period may commence. Any repairs to the system will retrigger the 30 day test period. Once the system has operated for a test period without any issues then it may be discussed to turn responsibility back to the Department. This must be documented with a letter to the Contractor and cc DOT Maintenance Electrical.

All maintenance or work on either the existing system or new system should be logged into the following sheet:

2-904 Maintenance and Protection of Traffic

“Maintenance and protection of traffic” may refer to Article 9.71 of the Standard Specifications, titled “Maintenance and Protection of Traffic,” or to the scheme for maintaining and protecting traffic in the contract plans and special provisions.

2-905 General

Traffic control is governed by the scheme for maintaining and protecting traffic in the plans and special provisions or, if there is no scheme, by the provisions in Article 9.71 of the *Specifications*. The contractor may request to deviate from either the scheme or *Specifications*. If a scheme exists, the contractor may offer an alternative that involves no additional cost to the Department and is acceptable to the Engineer. If the contractor wishes to deviate from the *Specifications*, a schedule may be submitted showing a proposed sequence of operations and a compatible method of maintaining traffic. The submission must be in writing, with suitable documentation to delineate cost savings or safety-effective measures that will be accomplished by the change.

Any request for a deviation in the specification for maintenance and protection of traffic must be approved by the Office of Construction prior to implementation. A copy of the written request from the contractor (and any other pertinent information) is faxed to the District Liaison Engineer and, if appropriate, to the Office of Traffic for review. The Office of Construction contacts the assigned traffic engineer for assistance in reviewing the request, and the District is contacted once the review is complete.

The contractor supplies a list of employees who will be responsible for performing necessary corrective work during and after normal working hours. This list should be made available to local or State police so the contractor can be contacted in emergency situations.

When a District reviews construction plans, consideration should be given to whether solid lane lines would be beneficial to traffic flow during stage construction operations. If the District feels solid lane lines would be beneficial, it should be brought to the attention of the responsible designer so that appropriate plans can be provided.

Approval from the State Traffic Commission (STC) is needed for most reduced speed limits. STC approval may be needed for signalization and other temporary traffic control measures if they are not directly related to the construction activities.

2-906 Payment

Inspectors' Daily Reports should list all items chargeable to the Maintenance and Protection of Traffic item.

The contract item Maintenance and Protection of Traffic is paid for as a lump sum. Generally, the item covers operational costs for material and devices furnished by the contractor under other contract items. Specifically, the price includes all costs for labor, equipment and services involved in the erection, maintenance, moving, adjusting, cleaning, relocating, and storing of signs, barricades, drums, traffic cones, and delineators furnished by the contractor, as well as all costs involved in the maintenance of traffic lanes and detours.

The item Maintenance and Protection of Traffic does not include the costs for furnishing and placing pavement markings; furnishing signs, drums, barricades, traffic cones, and delineators; or furnishing and placing borrow, gravel fill, crushed stone, bituminous concrete for patching, and pipe. These items are paid for under the appropriate contract items. If contract items necessary for maintenance and protection of traffic are not included in the contract, plans, or special provisions, then the necessary items are paid for as extra work.

The standard policy for proportional payments paid monthly under the contract item is to divide the number of contract days into the lump-sum dollar amount of the item and multiply the result by the number of contract days in the month. The monthly payment should be adjusted up or down based on the following.

- The contractor does not perform during the winter shutdown period and no maintenance and protection of traffic work is performed.
- It is foreseeable that the contractor will not complete the contract within the allowable days, and the delay is the result of contractor operations.

2-907 Contractor Nonperformance

The District Office should be notified immediately if the contractor will not correct a deficiency in the maintenance and protection of traffic. A meeting is held with the Project or Supervising Engineer, the Inspector, and the contractor to determine the corrections required. The provisions of Articles 1.07.07 and 9.71.01 of the *Standard Specifications* are reviewed with the contractor.

A time frame is given to the contractor to perform the work. If the contractor fails to perform the work within the required period, the State may perform or arrange for others to perform the work. The cost of the work performed by the State or others is deducted from the contractor's payment estimates.

2-908 Public Safety

Unless otherwise provided for under the contract, the roadway and its appurtenances must be kept open to traffic from the beginning of construction operations until final acceptance of the project. The contractor is responsible for keeping the portion of roadway under construction in such condition that traffic will be adequately accommodated, except for the removal of snow and ice, which is the responsibility of the Department.

The contractor is responsible for keeping the section of road being used by the general public free of irregularities and obstructions of any character that present a hazard or annoyance to them. Unless otherwise provided for under the contract, the contractor must incur all costs associated with maintenance work until relieved of responsibility. However, if a section of the project has not been disturbed by the contractor, the contractor is not held responsible for any incurred costs for repair of the undisturbed section. Payment in this case is as extra work.

Any portion of roadway which has existing roadway illumination and is open for use shall remain lighted. Temporary highway and under bridge illumination should be a major consideration on detours, stage construction of structures, ramps, and local roads during construction. Traffic or the consultant designer should approve any changes.

2-909 Potholes

All necessary precautions must be taken to protect the traveling public during patching operations. The Chief Inspector must keep proper documentation of the location of the pothole, amount of labor and equipment hours and total quantity of material placed.

2-910 Roadway Trenches

Any section of roadway under construction that is being used by the traveling public must be maintained free of potholes, ruts, trenches, bumps or ridges. At the end of the work day any closed section of roadway returned to the traveling public must be brought back to its proper grade. The final 2 in. (50 mm) must be completed with temporary cold patch material or hot bituminous concrete mix.

2-911 Low Bridge Clearance

The Bridge Safety Unit inspects bridges for vertical clearances. Both bridges within the project limits and bridges on project detours need to be inspected. Signage must be posted in advance of a structure that does not meet clearance standards, to forewarn traffic of the overhead clearance.

2-912 Storage of Equipment and Material

The contractor is required to store or place equipment and materials in locations that are not hazardous to the traveling public. The contractor must place or store material and equipment 30 ft. (10 m) or more from the edge of the travelway. An alternative is to locate the material and equipment behind a barrier system. If the alternative is used, the equipment and material must be a minimum of 3 ft. (1 m) farther away from the barrier than the barrier's maximum deflection. Figures 2-9.1 and 2-9.2 provide characteristics of operating guide rail and median barriers, respectively.

The storage requirements apply to construction signs, traffic drums, cones, etc., if not in use for lane or shoulder closures. These devices should be broken down and stored as described above. They should not be stored by leaning them against the traffic side of bridge parapets, rails or concrete barriers. It is not acceptable to place signs in a grassy area, turn them backwards or sideways, and not break them down.

At the end of each work day, all temporary construction signs must be picked up and removed to a safe storage area. If a signing pattern is to be reinstalled daily, suitable temporary marks should be placed on the roadway surface to ensure the repeated placement of the proper sign at the proper location.

Figure 2-9.1 Characteristics of Operating Guide Rail

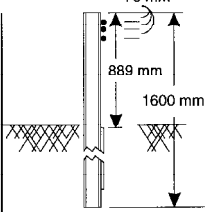
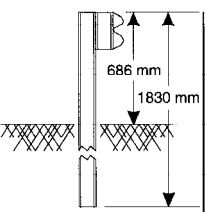
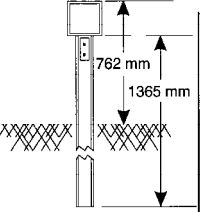
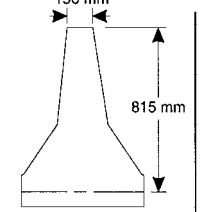
				
SYSTEM	<i>Three-Cable Guide Railing (I-Beam Posts)</i>	<i>Metal Beam Rail (Type R-B)</i>	<i>Metal Beam Rail 200 x 150 Box Beam</i>	<i>Concrete Barrier</i>
DEFLECTION*	3.66 m	1.25 m	1.25 m	0
POST SPACING	4900 mm	1905 mm	1830 mm	NA
TYPICAL POST	S75 x 8	W150 x 13	S75 x 8	NA
BEAM	Three 19 mm dia. Steel Cables	Steel "W" Section	TS203 x 152 x 6.4 Steel Tube	NA
OFFSET BRACKETS	None	W150 x 13	None	NA
MOUNTINGS	8 mm dia. Steel Hook Bolt	19 mm dia. Steel Bolt	Steel Paddles	NA

* Based on an impact of 97 km/h and an impact angle of 25°.

Figure 2-9.2 Characteristics of Median Barriers

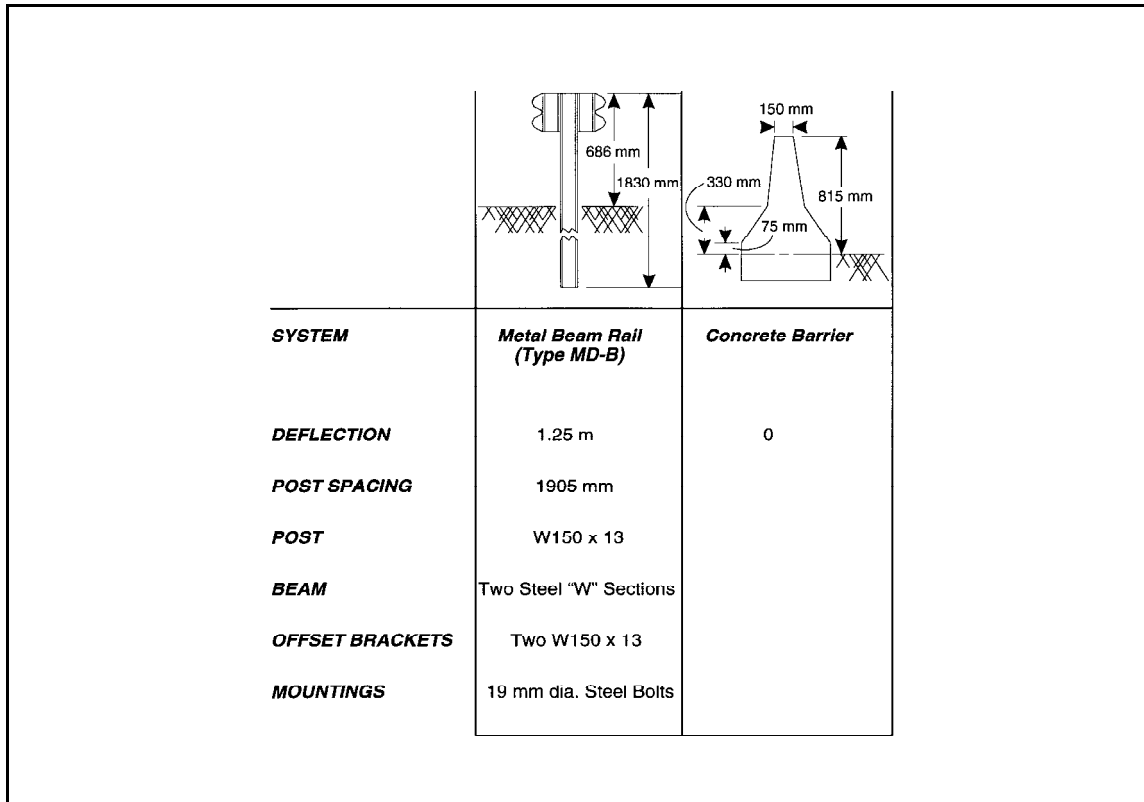

2-913 Removal and Reinstallation of Rail Systems

Contract items for removing and resetting existing rail systems must be completed at the end of each work day for every linear foot (meter) run where a hazardous situation exists. Situations that could present a hazard are offsets less than 30 ft. (9 m) from the edge of a travel lane, steep or vertical drop-offs, or fixed structures.

2-914 Limitation of Operations

A construction project on existing highways affects the traveling public. The Department has committed to the public to perform the work with minimum impact. Thus, limits are placed on the period the contractor can interfere with traffic. Limitations are based on the traffic volumes on a section of highway.

“Limitation of Operations” is the title of Article 1.08.04 of the *Standard Specifications*, concerned with conducting the work so as to produce the least interference with traffic. Specific limits on contractor operations, such as permissible hours of operation, are described in the contract's special provisions.

If called for by the contract, the contractor develops contingency plans for unanticipated problems such as equipment breakdowns, lack of material, etc. The plans must be approved by the District Office.

2-914A Requests for Changes

Requests to change the limitation of operations specifications for a project must be submitted in writing, through the District Office, to the Office of Construction. A request must follow the guidelines below.

- The request must include a description of the work to be performed, the reasons for the change, and any pertinent information regarding dates, times, and duration.
- The request must be submitted with enough time for it to be reviewed and a press release issued.
- The contractor must attach a copy of the pertinent specifications and indicate the sections that are proposed to be changed.
- The District must include a copy of the most recent hourly traffic counts by week and include any comments concerning the request. The District can request the traffic counts from Traffic and should maintain a file of the counts in the District for reference.
- The District must attach any previous press release that approved the same request as the current one.
- The District must include the detour route, if a detour is required. If a local road is to be detoured or used as part of the detour route, the District must attach the concurrence of the towns affected. The concurrence must be in writing.
- The District shall consider taking credit from the contractor when the change in specifications would allow the contractor an advantage in completing contract work under less restrictive terms (fewer days, fewer stages, day instead of night work, etc.).

The checklist shown in Figure 2-9.3, Request for Change to Contract Traffic Specifications, is used for compiling the information needed for a request. Approved requests are only for the dates and times specified in the approval.

Figure 2-9.3 Request for Change to Contract Traffic Specifications

REQUEST FOR CHANGE TO CONTRACT TRAFFIC SPECIFICATIONS

Contract Number: _____ Project Engineer: _____

Contractor: _____ Field Office Number: _____

Contact Person: _____ Route Number: _____

Lane configuration, including shoulders:

Existing (available): _____

Proposed: _____

The following are attached:

- 1) Location (including direction, lanes, ramps and exits, if applicable) _____
- 2) Dates, times, duration of change _____
- 3) Type of work to be done _____
- 4) Reason for the change _____
- 5) Description of detour (if applicable) _____
- 6) Traffic counts with comments _____
- 7) Map showing detour (if applicable) _____
- 8) Current specification, highlighting proposed changes _____
- 9) Previous press release with similar request _____
- 10) Written town approval (if applicable) _____
- 11) Should credit apply? _____

OOC Comment Section:

2-914B Expressway Projects

All lanes must be open on expressway projects during the peak hours of 6:00 a.m. to 9:00 a.m. and 3:00 p.m. to 6:00 p.m., Monday through Friday. In addition, expressway projects include holiday restrictions. Contract special provisions list the holidays.

2-914C Inspection

As construction progresses, project personnel should monitor all activities that may affect traffic operations. The Chief Inspector must review the contractor's plans daily to ensure that scheduled work can be completed and that the roadway can be opened to traffic within the period allowed by the contract.

The inspection staff must monitor the contractor's production rate to assure completion within the allowable time limits. If it becomes apparent that the contractor will not be able to open the roadway as required, the inspection staff must notify the contractor in writing to modify operations so that the roadway can be reopened on time. In addition, the inspection staff must notify the District Office of the problems encountered and actions being taken by the contractor, so that further action and direction may be taken if needed.

For example, a contractor may have a six-hour period in which to pave two lanes of a roadway. The Inspector should act, if at the end of two hours and 45 minutes, it is apparent that the contractor will not reach his planned ending station for the day's paving, and the contractor shows no sign of ending the first pass and beginning the second pass. The Inspector should give written directions to the contractor to end the first pass, begin the second and be off the road by the time stipulated in the contract. At the same time, the Inspector should notify the District of the problem.

When notified of a potential problem, the District must evaluate the actions being taken and determine if other action is required. District supervisory personnel (Project Engineer or Supervising Engineer) should be dispatched to the site to ensure all possible corrective actions are being taken. The District must determine whether the actions are sufficient to clear the roadway in time and, if they are not, immediately notify the Office of Construction. The notification should be made by telephone to the Supervising Engineer for the respective District or, if not available, any Supervising Engineer in the office. If the District feels the actions are adequate, no notification is necessary, but the project should be closely monitored to ensure further problems do not develop.

2-914D Liquidated Damages

If the contractor violates the limitation of operations provisions of the contract, the District must immediately investigate the facts surrounding the violation. At a minimum, the investigation should consider the following.

- Did the contractor (and Inspector) adequately plan the work?
- Was progress monitored and were adjustments made during the day to ensure timely completion?
- Was the contractor directed to alter the work to ensure timely completion? Was it in writing? Did the contractor comply?
- Were there any mitigating circumstances (equipment breakdowns, accidents, etc.)?
- Could anything different have been done to avoid interference with the traffic during restricted periods?
- What was the duration of the violation of the limitation of operations provisions? What was the impact of the violation (length of backup, amount of congestion, etc.)?

On completion of the investigation, the District must submit a complete report to the Office of Construction. The report should include all details relevant to the incident and a recommendation on whether a sanction should be applied. Sanctions include daily liquidated damage charges, if applicable. Administrative actions may be taken as deemed appropriate. The District must substantiate the reasons for its recommendation. The report and recommendation must be submitted within three working days of the incident.

It is not the intention of the Department to penalize contractors for minor infringements of the contract limitations or for incidents that do not adversely affect the motoring public. The procedures must be followed, however, when the contractor's operations violate the contract provisions and cause a significant impact on the flow of traffic.

2-915 Speed Limits

If a reduced speed limit is desirable over an extended period, the Division of Traffic Engineering prepares a report for the approval of the State Traffic Commission (STC). If it is approved, the reduced speed limit becomes effective when the signs are posted. The signs are the standard black-on-white speed limit signs. For long-term activities, the signs for the normal speed limit should be removed.

STC approval is not needed for activities extending over a portion of a day. Orange-and-black speed limit signs are used for posting the reduced speed limit.

The Office of Construction can request the STC to grant immediate approval of a reduced speed limit for an unforeseen situation. A special meeting will be held to approve the new temporary speed limit. The signs used are the standard black-on-white signs.

2-916 Business Access

Construction projects can significantly affect access to businesses. Project personnel must be proactive in mitigating business disruptions.

- Several days before construction affects a business, the Chief Inspector or Project Engineer should meet with the businesses that will be affected and explain what will be done, how long it will take, how business access will be maintained, etc.
- If detours or street closures will be implemented, signs stating, "Business Open-Local Access Maintained," must be provided.
- In all cases, access is maintained to all business properties. If necessary, temporary driveways are constructed. Temporary access is paved if it is in use for more than five days or through a weekend.

The Inspector should give special attention to ensuring business access is signed properly. Signs should be Code D-7 signs ("Business Access" signs) for both temporary and permanent access in construction areas. The signs should be installed on posts at heights that allow the signs to be visible but that prevent the signs from interfering with sight distances. In areas of two-way traffic, the signs should be mounted back to back so that one is visible from each direction.

2-917 Traffic Control Patterns

Traffic control patterns are used for the following:

- to divert traffic on all types of roadways away from a specific work zone,
- to protect work crews and inspection personnel from motorists entering a work zone,
- to maintain traffic at reasonable speeds around or through a work zone, and
- to alert or warn motorists of a work zone and to lead them through it.

Project plans and special provisions may contain both standard and custom traffic control patterns. The details spell out types and locations of signs and other channelizing devices. Some standard traffic control patterns are shown in Figures 2-9.12 through 2-9.40. They illustrate typical situations. Figure 2-9.4 illustrates terms that apply to work zone traffic control patterns.

Actual field conditions must be considered before applying the patterns. Adjustments may be made by the Engineer before placing a pattern, as explained later in this section. During placement, any existing signs that are in conflict with the traffic control pattern should be removed, covered or turned so that traffic cannot read them. After placement, the Inspector should review the pattern from a motorist's standpoint and direct the contractor to make any required adjustments to achieve a safe working pattern.

Figure 2-9.4 Terms for Work Zone Traffic Control Patterns

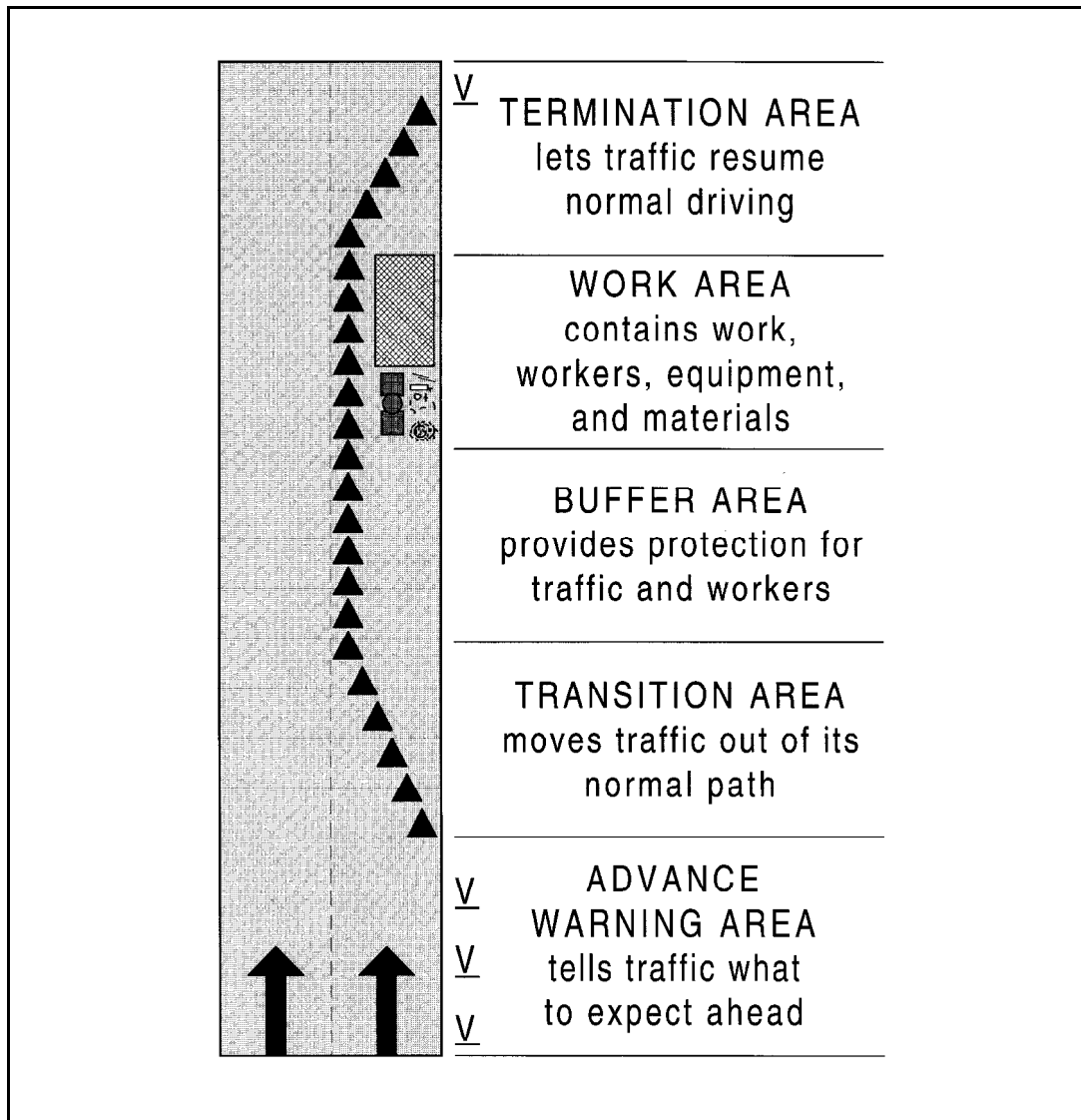
**2-917A Temporary Patterns**

A temporary traffic control pattern normally is in effect for the period allowed within the limitation of operations for daily traffic, typically 6 to 12 hours. The contractor must schedule operations and equipment to set up, maintain, and remove a temporary traffic control pattern within the allowed period. A temporary traffic control pattern consists of a combination of the following:

- construction signs mounted on legs
- trailer-mounted arrow boards
- trailer-mounted changeable message signs
- traffic cones
- traffic drums
- portable impact attenuation systems located at the work site

Custom signs may be required and effective under specific conditions or locations. After a temporary pattern is in effect, it should be checked periodically by both the contractor and inspection personnel for corrections or replacements.

2-917B Permanent Patterns

Permanent traffic control patterns are those that are not taken down on a daily basis. They are in place 24 hours a day. Permanent patterns consist of the same combination of channelizing devices as for temporary patterns, together with post-mounted construction signs and secured arrow boards or changeable message signs.

Typical lead-in post-mounted signs must be installed prior to implementation of a stage shift or extended closure. The signs should be covered until the pattern is affected. Cones, drums and leg-mounted signs should be properly weighted for extended use. Permanent sign patterns can include barricade warning lights on post-mounted signs and channelizing devices at the discretion of the Inspector.

Permanent sign patterns must be monitored at least weekly for any repairs or alterations.

2-917C Detours

Traffic control patterns for detours often are customized for the location and geometry of the detour. Detour plans usually are included in the contract specifications and drawings. It is important that detour signing and delineation is explicit, and it must guide the motorist back to the original route without confusion. Post-mounted signs should be large enough, contain minimal wording, and be placed at locations so that the motorist can be prepared to follow the prescribed detour.

2-917D Night Patterns

Traffic control patterns for standard lane closures are essentially the same for day and night operations. It may be necessary to adjust the spacing between channelizing devices at night to compensate for reduced visibility. It may be advisable to use additional arrow boards or changeable message signs and portable impact attenuation systems at night if the highway geometry and conditions warrant use. During nighttime operations, the contractor's vehicles are prohibited from traveling against traffic when their headlights are on and they are within a traffic control pattern.

2-917E Adjustments

The standard traffic control plans and patterns indicate the locations and spacing of signs and devices under ideal conditions. It is desirable to have signs and devices installed as shown on the standard plans and patterns, but sometimes adjustments are needed.

Adjustments to the standard signing plans and patterns can be made only at the direction of the Engineer. Installations should consider abutting properties, driveways, side roads, and the vertical and horizontal curvature of the roadway. If adjustments are made to the standard patterns, the adjustments should be to improve the visibility of the signing and devices and to control traffic better.

The Engineer may require that a traffic control pattern be located significantly in advance of the construction work site to provide better sight line to the signing and safer traffic operations through the

work zone. The Engineer may order the spacing between signs and devices to be increased or decreased as conditions dictate.

Any adjustments in the traffic control patterns are done by the contractor's forces and are at no extra cost to the State. Additional signs or devices required by the Engineer are paid at the contract unit prices for the items involved.

2-918 Tapers

A taper intended to shift traffic should be installed on a tangent section of roadway. Taper lengths may be reduced by the Engineer to a minimum of:

For speed limits greater than 40 mph (65 km/h)

$$L = \frac{W \times S}{1.6} \quad (L = W \times S)$$

and, for speed limits of 40 mph (65 km/h) or less, to a minimum of:

$$L = \frac{S \times S \times W}{155} \quad (L = \frac{S \times S \times W}{60})$$

- where:
- L = taper length in feet (meters)
 - S = speed limit in miles per hour (kilometers per hour)
 - W = lateral shift (width of lane or offset) in feet (meters)

2-919 Buffer Space

A buffer space should be provided between the transition taper and the work area. It should be free of equipment, workers, material and parked vehicles. On multilane highways with posted speeds of 45 mph (72 km/h) or more, the length of the buffer space should be at least 350 ft. (110 m).

2-920 Sign Placement

Signs usually are placed on the right side of the roadway. However, if a traffic lane is impeded on a multilane highway, signs should be installed on both sides of the roadway, if the median width is sufficient.

On one-way roads, such as off ramps, the same sign may be installed on both sides of the road, if the sight distance to the sign on the right side is restricted.

2-921 Inspection Responsibilities

The contractor furnishes signs, barricades, traffic cones, and traffic delineators to forewarn traffic of the construction. The State or the contractor provides the pavement markings, warning devices, and signs needed to safeguard and guide the traveling public through detours ordered by the Engineer or included in the approved scheme for maintenance of traffic. The contractor erects, maintains, moves, adjusts, relocates and stores the signs, barricades, traffic cones and delineators when, where and as directed by the Engineer.

The safe and proper handling of traffic is the contractor's responsibility. It is the responsibility of the State inspection forces to see that the contractor provides for the safe movement of traffic. However, inspection forces should be careful not to issue instructions that shift the burden of responsibility to themselves or the State. State inspection forces must enforce the requirements of the contract and call the contractor's attention to any dangerous situations that may arise.

The Chief Inspector supervises the handling of traffic when traffic is maintained over all or a portion of the project. The Inspector's goal should be to ensure safety and minimize delays and inconvenience to the traveling public and to adjacent property owners and businesses consistent with the prosecution of the work. The Inspector sees that the traveled roadways are of sufficient width, drained, reasonably smooth, and in suitable condition at all times.

The Chief Inspector must maintain good records of installed traffic control patterns. The records should include dates and times of day that inspections are made, statements of conditions found, a complete list of the types, sizes and locations of devices, orders to the contractor to make changes or corrections, the times and dates devices are removed or modified, photographs of installed patterns that are expected to remain for long periods, and comments explaining variations from standard procedures. The records are maintained in the Inspector's Daily Report. Traffic control is a contractual responsibility of the contractor, but the State could also become liable due to its actions or inactions.

2-921A General Inspection

The items below are part of the overall inspection responsibilities for construction traffic.

- The Inspector must review the contract plans and special provisions relating to maintenance and protection of traffic. The Inspector must review the construction site for problem areas so that needed adjustments or improvements are identified.
- The project must be reviewed before erecting signs. The Chief Inspector should make suggestions, through the Project Engineer to the Assistant District Engineer, for special conditions not anticipated in design needed to improve the safety of the work force or the traveling public. The Engineer should direct special attention to signing for business access. All changes in the contract requirements must be approved by the Division of Traffic or the consultant designer.
- Throughout construction the Inspector must monitor the signs, flashers, drums, cones, pavement markings, delineators, etc., and direct the contractor to repair and maintain the devices as necessary. The Inspector should ensure that all devices are properly spaced, clean, the correct color, and as reflective as required. Periodic inspections should be made during both the day and night.
- The Inspector ensures that the traveling public is treated in a courteous manner by the trafficperson, inspection forces, and contractor's forces.

- Special attention must be paid to the construction area and its approaches after winter storms. If traffic devices are displaced, damaged, or dirtied by snow removal operations, they must be made serviceable as soon as possible.

2-921B Traffic Flow

Traffic flow should receive special attention from project personnel because of its importance and because of the Department's commitment to minimize interference with traffic. The Inspector must, at a minimum, follow the guidelines below:

- review signing patterns when they are established;
- periodically inspect signing and the resulting traffic queues during the work day;
- adjust or add signs to improve traffic flows and to reduce impacts;
- notify the District Office of significant problems; and
- review the use of trafficperson and add trafficperson if needed, such as at signalized intersections.

If significant traffic backups occur, the Inspector should consider ordering the contractor to reopen closed lanes to allow traffic to pass, but only if the lanes can be reopened safely. If practicable, adjustments should be made to the construction process to minimize effects on the traveling public and on the adjacent property owners and businesses.

If significant problems occur, the Inspector should notify supervisory personnel or the District Office. If additional help is needed, the District Office should request it from the Office of Traffic.

2-921C Lane Closures

A traffic control pattern must be installed before starting any contract operation that interferes or conflicts with any travel lane or shoulder. To provide for traffic control during lane closures, the guidelines below should be followed.

- The contractor must inspect all traffic control devices daily and correct any deficiencies.
- Existing pavement markings and signs must be removed, covered, or turned so that traffic cannot read them, if they conflict with the traffic control plans or contract drawings. At the completion of the project, the existing striping and signage must be reestablished as directed by the Engineer.
- Traffic control devices that are not needed for current work must be removed or covered from the sight of motorists.
- The contractor is required to install and remove all temporary pavement markings during and between construction stages, as indicated on the plans or as ordered by the Engineer.
- The contractor is responsible for maintaining a clear and safe travelway for vehicles. Storage of material, equipment, or debris outside of the designated work area is not permitted.
- If work on adjacent projects is occurring simultaneously, the contractor must maintain coordination for proper traffic flow.

Volume 2

2-922 Detours

The Contract provides a detour when a portion of a State highway is closed because of construction or reconstruction.

2-922A Detour of a State Highway to a Town Road

The procedure below is for a detour of a State highway to a town road.

- The need for a detour is determined during the preliminary review of the plans for the proposed construction. The Manager of Traffic Engineering selects the layout of the detour.
- The Manager of Traffic Engineering informs the appropriate town official of the pending detour. (Additional information is provided to the town officials later in the process.)
- The Manager of Traffic Engineering arranges a meeting with the town official and the District Maintenance Manager to select, inspect, and agree on local roads to be used for the detour.
- The designer, in conjunction with the Office of Construction, decides on including the detour signing and temporary roadway improvements in the contract or having them performed by the Office of Maintenance.
- The District Engineer sends correspondence about the detour schedule to the principal administrative town official and the local fire and police departments. In addition, the District Engineer notifies the District Maintenance Manager and notifies the public transportation companies and ambulance services operating within the area that may be affected by the detour. The District Engineer keeps these parties informed of any changes concerning the detour during its use, as well as notifying them of the detour's termination.
- After the detour is no longer required, the town road is restored to a condition comparable to that existing before the detour was established. Preliminary and final condition reports of the roadway are performed.

2-922B Detour of a State Highway to Another State Highway

The same procedure is used for a detour of a State highway to a State highway as is used for a detour of a State highway to a town road (see above), except that it is not necessary to consult the town officials.

2-922C Detour of a Town Road to Another Town Road

The same procedure is used for a detour of a town road to a town road as is used for a detour of a State highway to a town road (see above), except for the following:

- The principal administrative town official requests the Commissioner, in writing, to establish a detour diverting traffic from the town road.
- It is not necessary to consult with the town official concerning maintenance or other work on the road used as a detour.

“Principal administrative town official,” as used here, refers to the Mayor or City Manager of a city, Board of Selectmen or Town Manager of a town, or Warden of a borough.

2-922D Temporary Detours

The District Engineer, with the concurrence of the Office of Construction, may establish temporary detours that do not exceed 48 hours duration. The District Engineer determines the sign requirements for temporary detours and is responsible for placing and removing the signs. After a detour, the District Engineer ensures that the local roads are restored to conditions at least as good as those prevailing before the detour.

On establishing a temporary detour, the District Engineer notifies the appropriate town officials, who in turn, inform the local fire and police departments. In addition, the District Engineer provides the dates and hours that the detour will be in operation to the Manager of Traffic Engineering and the public transportation companies and ambulance services operating in the area.

2-922E Detour Operations

A detour can be made operational after all required agreements are executed; traffic control signing is installed; local officials, fire, police, etc., are notified; and the contractor is ready to start work. The Chief Inspector on each project must:

- inspect the location of all construction, warning and detour signs erected to ensure that they are properly installed; and
- arrange for the maintenance of the detour to safeguard the public against any hazards arising out of its use.

2-923 Construction Signs

2-923A Signs

Construction warning signs are furnished and erected by the contractor. The number, size and type of signs are set forth in the plans and special provisions.

The sheeting for signs used on expressway projects must be wide-angle reflective sheeting. The sheeting for other signs is encapsulated-lens reflective sheeting. One type of sheeting must be used throughout a project. If a project is predominantly an expressway project, with some work at ramp terminals or over at-grade roads, the wide-angle sheeting is used.

The use of unauthorized or unapproved signs is not to be permitted. All signs in any one signing pattern are mounted the same height above the roadway. Care should be taken so that weeds, shrubbery, construction materials, or equipment is not allowed to obscure any sign, light or barricade. Signs that do not apply to existing conditions should be removed or adjusted so that the legends are not visible to approaching traffic. All legal signs closing the roadway to traffic, as shown on the plans or directed by the Engineer, must be erected before starting any work on the project. The signs remain in place until the final inspection has been held and all corrective work has been completed.

When construction warning signs are no longer required, the Assistant District Engineer or a representative directs the contractor to remove the signs. The contractor must remove them promptly.

2-923B Ordering

The Inspector should review the plans and specifications to determine if the types and quantities of signs are sufficient to do the work and are included in the contract. The Inspector should address any special conditions not addressed in the plans.

The Inspector should conduct a field review of all sign locations for possible conflicts and advise the contractor of changes. The Inspector should consult with the Engineer if changes are made to the signing and the effectiveness of the signing is questionable.

2-923C Placement

In determining the locations of the signs, the horizontal clearances should be checked to ensure that the signs will not be obstructed by other objects. Placement of the signs should be in accordance with traffic standards.

A field review of the signs should be made by both day and night to ensure that the project site is properly signed and that signs are legible and in good condition. Damaged or missing signs should be replaced as needed in a timely manner.

Review contract specifications for details of measurement and payment. Make necessary measurements for payment to the contractor.

2-923D 16-Series Signs

16-Series (“Construction Ahead”) signs must be installed on all projects. They should be installed on all roadways that enter the project limits. The signs should be installed in advance of traffic control patterns and, if practicable, at locations that allow the traveling public to exit the roadway before entering the project work limits. The sizes of the signs are as shown in the contract documents. The signs must be installed before any work can commence on the project and must not be removed until the contractor is relieved of physical responsibility for the project. Additional information about 16-Series signs is in Figure 2-9.10.

There are several types of construction projects that require legal blocking of the highway during the time the contractor is actively engaging in the work. The activities move quite rapidly along the highway, and there is no need for the semi-permanent erection of 16-Series signs at both ends of the projects. For example, on joint sealing contracts the 16-Series signs are erected each morning and taken down at the end of the day's activities. The signs are erected the following working day and again taken down at the end of the working day. The location of the signs moves day to day as the contractor progresses in the work.

2-923E Inspection

Some important inspection guidelines about contractor-furnished signs are:

- The signs installed should be used in the position and for the purpose designed. Field changes should be made only after consultation with the District Office and the Division of Traffic.
- Individual signs should be used only if the wording is appropriate. Indiscriminate use of signs can be dangerous and confusing.
- Frequent checks by field forces should be made to ensure signs are in place, are legible, are lighted as needed, and are used only as authorized.
- If signing is needed for a detour or other specific situation, check with the District Office for plans from the Division of Traffic.
- There should be no delay in signing or re-signing situations as they develop.
- Advance detour signs used during intermittent periods of construction should be removed when they are no longer appropriate.
- Signs, barricades, and other channelizing devices used to control and direct traffic at temporary connections to sections of completed construction must be sufficient to provide for safe, continuous traffic movement at a reasonable speed.
- Partially completed sections of highway that are not officially open to traffic should be effectively closed with barricades.

The Chief Inspector ensures that all traffic directional signs are preserved. If they are disturbed by construction, the Inspector should have them reset as often as needed, so that they are visible and of use to traffic.

2-924 Barricade Warning Lights

In addition to what is required in the contract, the Engineer determines if any changes of barricade warning lights are needed.

The contractor furnishes and securely fastens the units to signs, barricades, and other objects in the numbers and for the lengths of time ordered by the Engineer. The contractor maintains and relocates the units and, upon final removal, disposes of them. Traffic devices should be kept clean and replaced if damaged.

2-925 Extended Shutdowns

If a contractor plans an extended shutdown (over 30 days) on projects such as signing, illumination, planting, etc., the District Engineer notifies the Manager of Construction Operations, who advises the Manager of Traffic Engineering. With the written concurrences of the contractor's insurance carrier, the Manager of Traffic Engineering may recommend the temporary removal of the construction signs. If the Manager of Construction Operations approves the recommendation, the District Engineer responsible for the project is directed to remove the construction signs as soon as possible after the temporary shutdown has been granted by the Office of Construction.

2-926 Changeable Message Signs**2-926A Portable Signs**

Portable changeable message signs (PCMS) can display a variety of messages. They are used most frequently in high-density urban freeways but may be used on any road if highway alignment, traffic routing, or other conditions require advanced warning and information.

PCMSs typically are used in temporary traffic control to advise drivers of the following:

- ramp, lane or roadway closure;
- substantial drops in traffic speed;
- significant queuing and delays;
- adverse environmental conditions;
- changes in alignment or surface conditions; and
- accidents or incidents.

The contractor furnishes and maintains a trailer-mounted changeable message sign at the locations indicated by the plans or by the Engineer. The Inspector should direct the contractor to place the sign so that it is visible at least ½ mi. (0.8 km) in advance of the work zone. Other guidelines for placement are below.

- PCMSs typically should be placed in advance of any other traffic control signing and should not replace any required signing.
- If a PCMS is used for route diversion, it should be placed far enough in advance of the work site to allow traffic ample opportunity to exit the highway.
- PCMSs normally are placed on the shoulder. If practicable, they should be placed farther from the traveled lane.
- If two PCMSs are needed to communicate multiple messages, they should be placed on the same side of the road, separated by at least 1000 feet (300 meters).

The Inspector should refer to the traffic control plans included in the contract for the message that should be displayed. The Inspector may order the contractor to change the message as deemed necessary. PCMS messages should be readily understood by drivers and, thus, allow them adequate time to react. Guidelines for PCMS messages are:

- No more than two displays should be used within any message cycle.
- Each display should convey a single thought.
- Messages should be as brief as possible.
- Any abbreviations used should be readily understood.
- The entire message cycle should be readable at least twice at the posted speed, 85th percentile speed prior to starting work, or the anticipated operating speed.
- Messages must not scroll horizontally or vertically across the face of the sign.

A changeable message sign should not be used to provide a static message that can be as effectively communicated with a standard construction sign. For example, a changeable message sign should not be

used to display “Road Construction Ahead” continuously. A changeable message sign should be discontinued as soon as the condition requiring the message is removed from the travelway.

The Inspector establishes a log of the message that is being displayed, the time, and the duration. The log should be included in Volume IV. The Department pays for the sign at the contract unit price per day that the sign is in operation. If a sign is in operation for part of a day, payment is for a full day.

2-926B Permanent Signs

There are permanent changeable message signs throughout the State. The signs may be used to forewarn drivers of work site activities. The Project Engineer should contact Traffic Operations in Newington to determine whether one of the signs should be used.

2-927 Arrow Boards

Arrow boards may be used in either the chevron mode or the caution mode. In the chevron mode, the arrow board displays a series of moving chevrons. The mode may be used for stationary or moving lane closures. In the caution mode, the four corner bulbs of the arrow board are set to flash. The mode should be used only for shoulder work, blocking the shoulder, or roadside work near the shoulder.

For a stationary lane closure, the arrow board should be located on the shoulder at the beginning of the taper. If the shoulder is too narrow for the arrow board to be completely off of the closed lane, it should be placed to use as much of the shoulder as practicable.

Arrow boards must not be used on a two-lane roadway for temporary one-lane operations. They must not be used on a multilane roadway to shift all lanes of traffic because unnecessary lane changing may result.

2-928 Channelizing Devices

2-928A Barricades

Type III barricades generally are used for the following:

- to temporarily block and secure a construction site from traffic during on and off peak hours,
- to delineate a road or bridge closure in conjunction with signing and flashers, or
- to temporarily close ramps.

Type III barricades should not be used as physical barriers to stop traffic completely. If a road or bridge closure or project contains a hazard where vehicles may enter the work zone, a solid concrete barrier system should be used. The number and position of Type III barricades may be varied by the Engineer to best suit field conditions.

2-928B Temporary Precast Concrete Barrier Curb

Temporary precast concrete barrier curb (TPCBC) is used for the following:

- to channelize traffic through a work zone,

- to protect a work site from adjacent traffic,
- for extended road or bridge closures, and
- to protect a temporary installation of an arrow board or changeable message sign.

Figure 2-9.5 shows a section of TPCBC.

Figure 2-9.5 Temporary Precast Concrete Barrier Curb

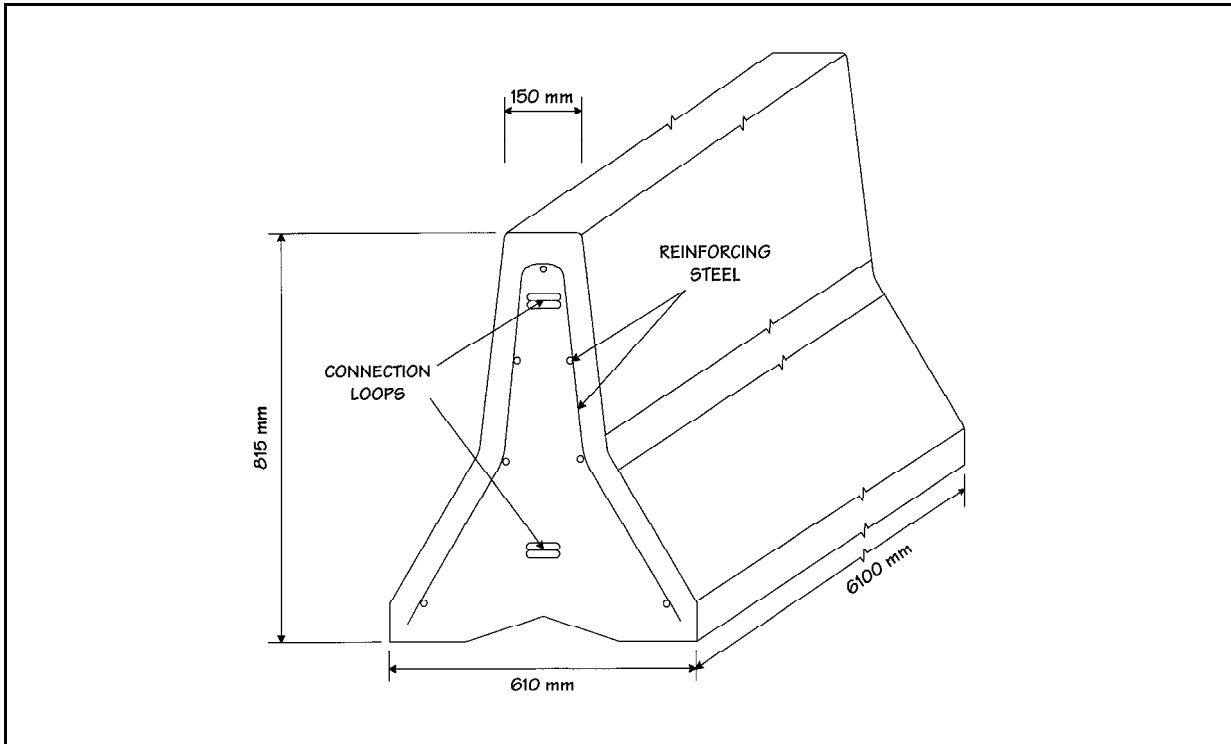

2-928C Installation

A typical TPCBC installation is shown in Figure 2-9.6.

2-928D Taper Length

Taper length is important when installing TPCBC. A rule of thumb is that barrier curb placed on an expressway or major highway is placed with a taper, or flare, of 1:10, a lateral offset of 24 in. (600 mm) for every 20 ft. (6 m) section of barrier curb. The taper should be changed to a larger offset per length only with the approval of the Engineer. Section 2-916E, “Adjustments”, includes more information about modifying a taper. The Inspector, with the contractor, should review the field conditions and discuss placement of TPCBC prior to either a standard installation or one as described by the contract drawings.

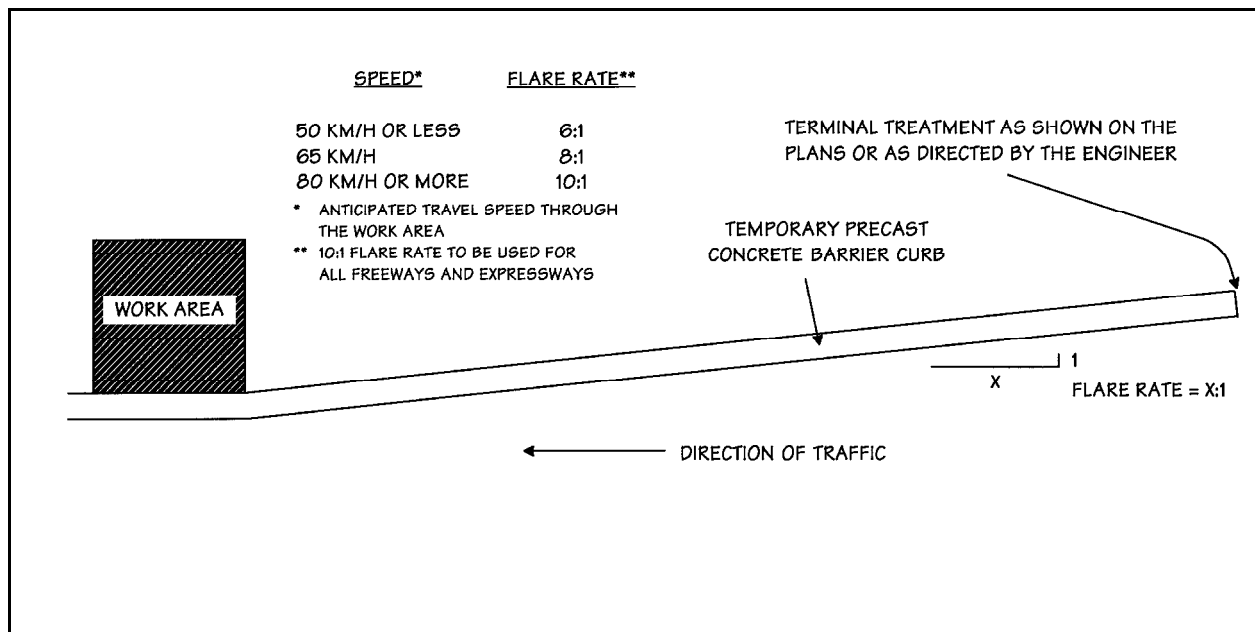
Figure 2-9.6 Typical Temporary Precast Concrete Barrier Curb Installation

2-928E Delineation

It is important that temporary barrier curb be delineated properly for nighttime traffic. Field conditions generally dictate placement of DE-7, DE-7A and DE-7C delineators. If a shifted lane with barrier curb extends for a long distance, the required delineators may be reduced to 1 per 0.1 mi. (0.16 km). As a closure is reduced in length, the installations may be adjusted up to 1 per 20 ft. (6 m) length of barrier. Type DE-7C delineators must be used if a temporary barrier separates lanes with traffic moving in opposite directions.

All temporary barriers installed to separate opposing traffic lanes and traffic lanes from the work site should have delineators installed on them as follows:

- if the barrier is placed anywhere on the paved roadway surface, including shoulders; or
- if the barrier is off the paved surface but within 12 ft. (3.5 m) of the edge of a travel lane.

Highway or street illumination does not negate the need for the delineators.

The delineators must be Type DE-7, DE-7A, DE-7B or DE-7C, depending on the location at which they are installed. Silver delineators must be used to delineate the right-hand edge of the roadway, and yellow delineators must be used to delineate the left-hand edge of the roadway. If barrier is relocated, the type of delineator may need to be changed. The delineator change must be made the same day the barrier is relocated.

2-928F Attachment

TPCBC bridge sections must be affixed to a bridge deck by drilling and grouting dowels. Details for the attachment are in the contract drawings. It is imperative that both PCBC bridge and roadway sections be connected end to end to prevent movement of sections of barrier. The condition of the delineators must be

monitored by the Inspector for replacement by the contractor. The Inspector should ensure that all temporary pavement markings are installed prior to using temporary barrier for shifting lanes.

2-928G End Treatments

There are various end treatments for TPCBC, including physical connection to an existing barrier, burying in a backslope, protecting by crash cushions, burying in a berm, or using a tapered or ramped concrete end section. Ends of barriers must be adequately treated using one of the prescribed systems.

2-928H Component Inspection for TPCBC

The following components should be inspected regularly.

- *Connection Rods.* Inspect for missing or misaligned rods. Ensure that the rods are not damaged. For older installations, ensure that the cotter pins are installed through the lower end of the connection rod. Figure 2-9.7 shows a TPCBC connection assembly with a threaded connection rod.
- *Connection Loops.* Inspect all connection loops at the end of TPCBC for breaks, cracks, and excessive deformation that prevents proper connection to the adjacent TPCBC section. Replace sections that have loop deficiencies. All barriers must be connected.
- *Concrete.* Inspect concrete for serious damage. Replace damaged sections as needed.

2-928I Payment for TPCBC

There are two possible pay items for TPCBC used for construction traffic control:

- Temporary Precast Concrete Barrier Curb, and
- Relocated Temporary Precast Concrete Barrier Curb.

The original installation and final removal of barriers from the work site do not qualify for payment under Relocated Temporary Precast Barrier Curb. Payment for the work is under Temporary Precast Concrete Barrier Curb.

Payment under Relocated Temporary Precast Concrete Barrier Curb applies to the work listed below.

- Each barrier relocation at the work site for stage construction or maintenance and protection of traffic.
- Each removal of the barrier from the work site to a temporary storage area.
- Each retrieval of the barrier from a temporary storage area and installation at a project work site. The work site may be anywhere on the project (or projects for multiple contract projects).

There is no payment for costs associated with the temporary storage of barrier, such as for rental of storage space, rental or lease of concrete barrier, cost of security or insurance, etc.

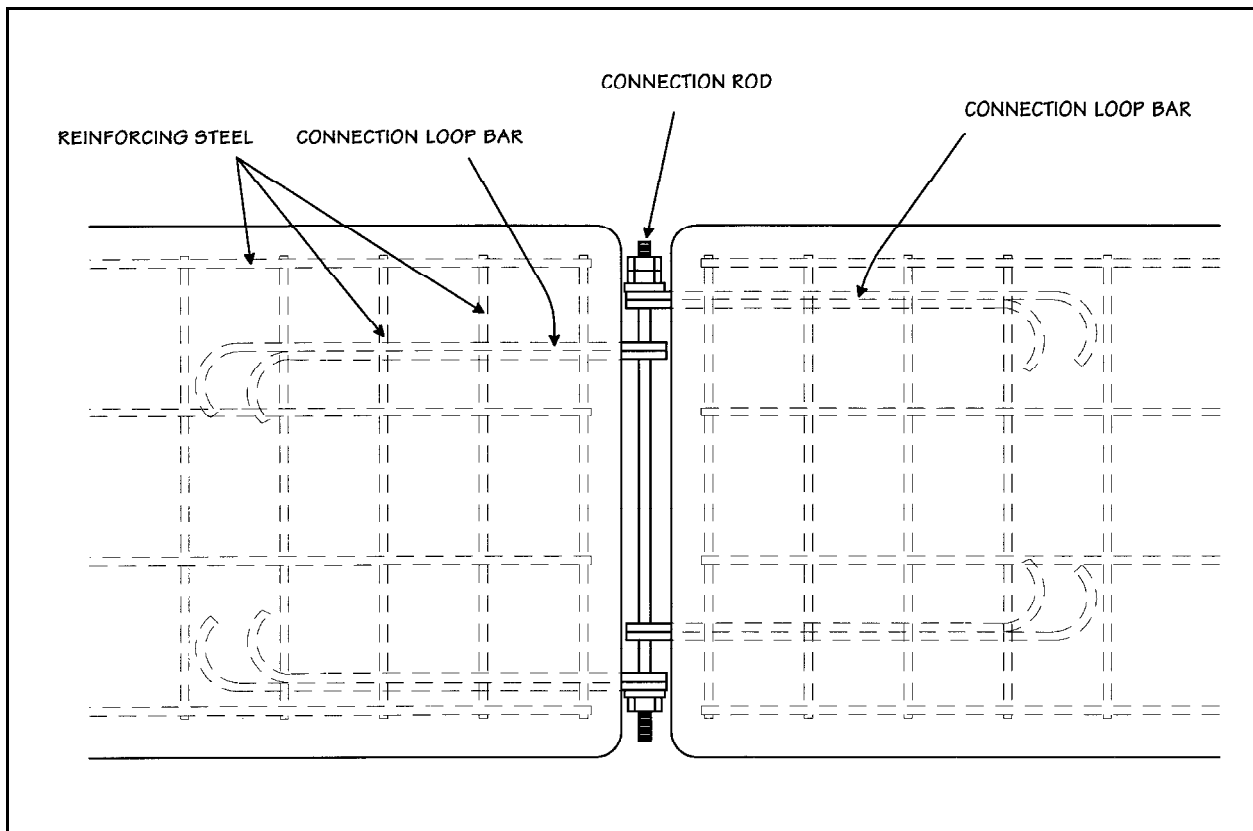
Figure 2-9.7 Connection Assembly for Temporary Precast Concrete Barrier Curb

2-929 Impact Attenuation Modules (Sand Barrels)

Sand barrels with DE-9 delineators are used for the following:

- to protect blunt ends of temporary PCBC,
- to protect arrow boards and changeable message signs adjacent to travelways, and
- to protect incomplete portions of work.

If sand-barrel arrays are not proposed on the contract drawings but the field conditions warrant the installation, the item will be initiated immediately. Additional barrels can be authorized by the Chief Inspector. There must be no blunt ends at any time in the work zone. Type DE-9 delineators must be installed on the lead sand barrel in any sand-barrel array.

If an unprotected PCBC installation, arrow board, or changeable message sign is within 30 ft. (10 m) of the travelway, a sand-barrel array is required at the blunt or exposed end. The location of the blunt end (expressway, highway or secondary road) and the speed limit determine the number and size of the sand barrels. Guidelines for sand-barrel installations are available in the District. The guidelines use speed limits and lateral offsets for proper placement.

It may be necessary to install a sand-barrel array at a completed bridge parapet or median barrier curb during stage construction until the proposed metal beam rail systems can be completed.

Volume 2

2-930 42 Inch Traffic Cones

42 inch (one-meter) traffic cones are used for the following:

- within any lane closure on an expressway if the pattern extends for a long distance, and
- any nighttime lane closure on any State road.

Figure 2-9.8 shows a traffic cone.

Traffic cones, 42 inches (1 meter) in height should be reflectorized in a manner similar to the current traffic drums. The standard spacing can and should be adjusted to adapt to field conditions. Conditions that may warrant a decrease in the spacing length are poor sight line or localized work areas within a lane closure. It always is best to review a sign pattern and make the proper adjustments to cone spacing for maximum work zone safety for both traffic and personnel on site.

Figure 2-9.8 Traffic Cone

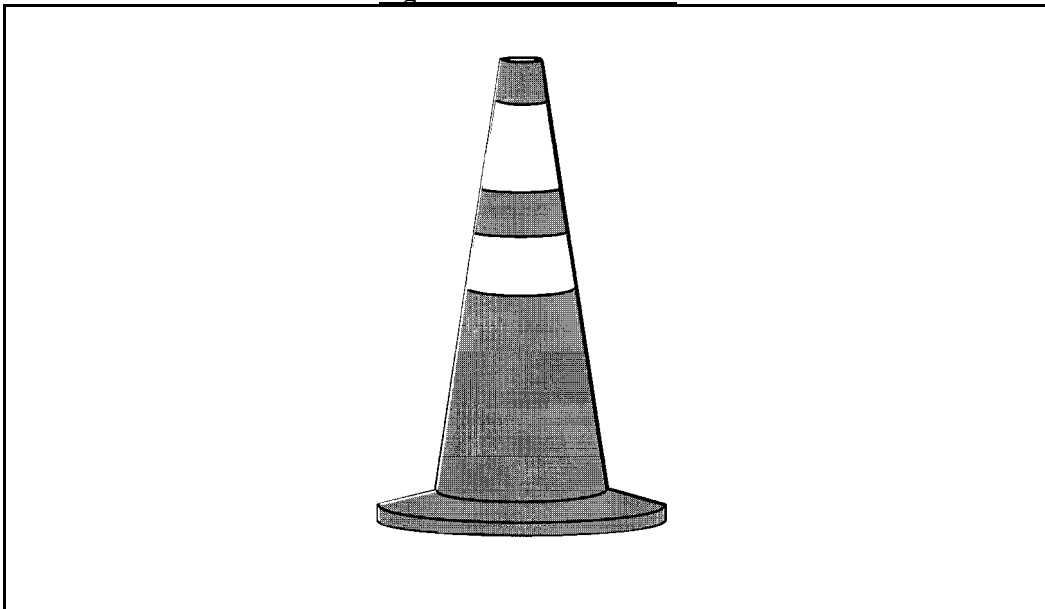

2-931 Traffic Drums

Traffic drums are used for the following:

- to channelize or delineate traffic flow through shorter patterns, generally on secondary roads, and
- to delineate a specific hazard or work zone.

Figure 2-9.9 shows a traffic drum.

Figure 2-9.9 Traffic Drum

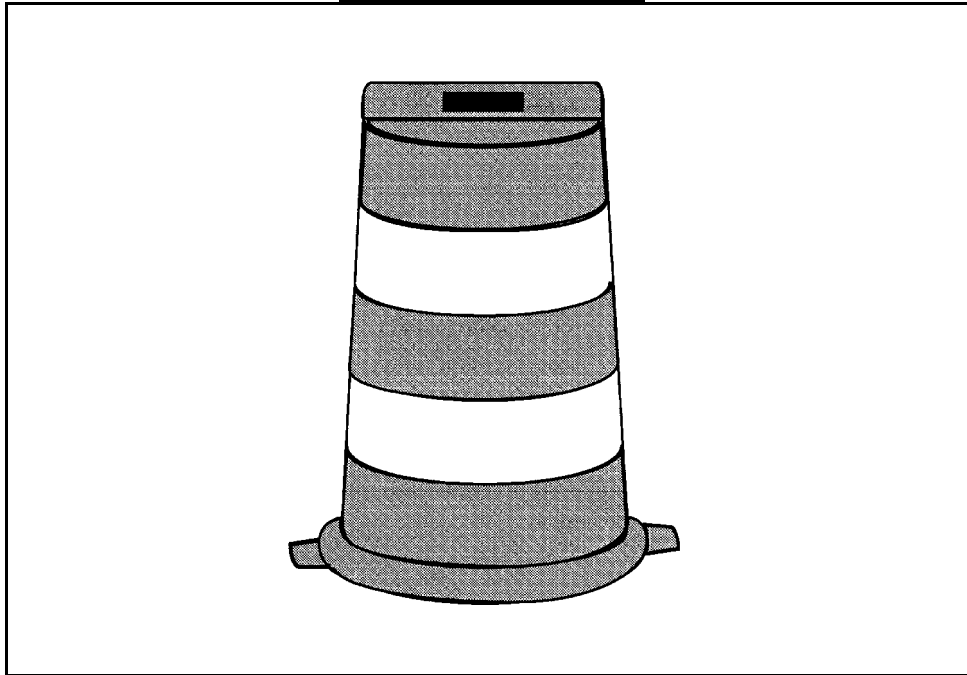

Drums are used in conjunction with advance warning signs and intermediate arrow signs in a lane or partial road closure. They should not be weighed down with materials that make them hazardous to motorists, pedestrians, or workers. Drums should be weighted at the base, not on the top. All drums should have drain holes to avoid water accumulation and freezing. The reflective sheeting must be kept clean, which is a responsibility of the contractor. Any drums that no longer perform as specified are to be replaced by the contractor at no cost to the State.

Barricade warning lights should not be used on plastic reflectorized drums. Type C steady-burn lights usually are ineffective and overpowered by the highly reflective sheeting required on plastic traffic drums. The District may review with the Office of Traffic special instances in which warning lights may be desirable.

2-932 Pavement Markings

The Chief Inspector should review the striping plans, any special requirements, and standard details prior to the beginning of work. He should compare field conditions with the striping and marking plans for conflicts and to ensure the compatibility with existing traffic patterns.

2-932A Painted Markings

Painted pavement markings are used as temporary markings on temporary pavement or on existing pavement that will be resurfaced or removed. The markings should be installed in accordance with traffic plans and specifications.

2-932B Temporary Plastic Markings

Temporary plastic pavement tape is used on permanent pavement when the interim markings do not coincide with the final markings or in temporary transition areas. It should not be used if painted pavement markings are acceptable. For example, paint is used for temporary markings when resurfacing limited access highway-tape is unacceptable. Preformed black line-mask tape is used temporarily to cover existing markings that are to remain after construction.

Temporary plastic pavement markings should be installed in accordance with traffic plans, specifications and current manufacturers' recommendations. They must be installed on a dry, clean pavement and within the correct temperature ranges.

Prior to the placement of plastic tape, the Inspector should identify the product that the contractor will use and verify that it is acceptable. The product can be identified by looking at the markings on the tape box or on the back of the tape. The Inspector should notify the contractor of any tape that becomes displaced or is not effective. The contractor must replace it within 24 hours.

2-932C Marking Removal

Removal should be in accordance with current standards and should not damage the existing pavement. Grinding is not permitted.

2-933 Portable Impact Attenuation Systems (Crash Trucks)***2-933A Use***

The contractor indicates on the bid proposal the type of system proposed for use. The contractor must use the system as directed by the Inspector. The system is used instead of the item Trafficperson. The general guidelines for use are below.

- Only one system is authorized per critical sign pattern, such as sign patterns for left-lane closures, closures without shoulders, high-volume areas, and interchanges.
- Shoulder closures and right-lane closures generally can be implemented without use of an impact attenuation system.
- Crash trucks should be used in the following situations:
 - left-lane closures with minimal median widths for setting up advance warning signs and staging;
 - lane and shoulder closures on turning roadways or ramps or on mainlines if sight distances are minimal; and
 - closures where extensive turning movements or traffic congestion occurs.

The Inspector reviews the need for a portable impact attenuation system with the contractor. The Inspector directs the contractor to place the system in advance of the work zone where it is most visible to approaching traffic and effective in protecting workers.

2-933B Inspection

The Inspector makes a visual inspection of the system to ensure that it meets the requirements of the specifications. If the system is not new, the contractor must document or demonstrate that the system conforms to the requirements. A Material Certificate is required for each new system.

The system is mounted on a truck. The Inspector should inspect the truck for the following:

- the correct gross vehicle weight for the type of attenuation system,
- two flashing strobe lights mounted high enough to be fully visible from the rear, and
- an internally illuminated flashing arrow.

The flashing arrow must be a Type C arrow panel with a minimum size of 48 in. × 96 in. (1.2 m × 2.4 m), at least 15 panel lamps, mounted at least 7 ft. (2 m) above the pavement. It must have a minimum lighting distance of 1 mi. (1.6 km).

The attenuation system must have a DE-9 delineator attached to the front module with bolts or vandal-resistant hardware.

The Department pays for the system at the contract unit price per hour of use.

2-934 Trafficperson**2-934A General**

Current contracts provide for the services of uniformed trafficperson as a contract item at the locations and for the periods ordered by the Engineer. Trafficperson are used for the control and direction of vehicular traffic and pedestrians. There are three types of Trafficperson.

- *Uniformed Flagger.* These trafficpersons are clothed or equipped (including headgear) so as to be readily distinguishable as trafficperson, per the specification requirements. With the exception of emergency situations, these flaggers are to have successfully completed a flagger training program approved by the Department.
- *Town or City Police Officers.* These trafficpersons are uniformed town or city police officers from the town or city police department in which the project is located. (If uniformed police officers are not available, a town constable may be used.)
- *State Police Officers.* These are uniformed, off-duty, sworn Connecticut State Police officers used to control traffic operations and promote increased safety to motorists on expressway construction sites. Services include the use of an official State Police vehicle and associated equipment.

Authorized trafficpersons normally render service within limits of the construction, within the right-of-way for the project, on detours stipulated in the contract, and on detours ordered by the Engineer. Trafficpersons are not authorized if they are furnished by the contractor beyond the period for which the Engineer deems necessary or at locations where traffic is unnecessarily restricted by the contractor's method of operation.

2-934B State Police Officers

State Police officers are the only type of trafficpersons that can be used on limited access highways.

- Only one State Police officer is authorized per critical sign pattern, such as sign patterns for left-lane closures, lane closures without shoulders, high volume areas, and interchanges.
- Shoulder closures and right-lane closures generally can be implemented without State Police presence. Likewise, in areas with moderate traffic and wide, unobstructed medians, left-lane closures can be implemented without trooper presence during daylight hours. General exceptions to this policy are:
 - Left-lane closures with minimal median width for setting up advance signs and staging.
 - Lane and shoulder closures on turning roadways, turning ramps, or mainlines where sight distances are minimal.
 - Closures where extensive turning movements or traffic congestion occurs.
- Any lane closures at night generally require a portable impact attenuation system and a State Police officer to install the sign pattern.
- If there is doubt that a trafficperson is required, the District Office should be contacted.

After the sign pattern is in place, the State Police officer should be stationed at the beginning of the pattern. If traffic starts backing up, the officer should move to the beginning of the waiting line of vehicles or at the work site, whichever location is more effective. The trafficperson should be out of the cruiser and assisting to control traffic.

2-934C Town or City Police Officers or Uniformed Trafficpersons

Town or city police officers and uniformed trafficpersons are restricted to roads without limited access.

2-934D Prior Approval

Project personnel will inform the contractor once a week in writing of the operations requiring trafficpersons. The District maintains copies of the communications. The State does not pay for trafficpersons deployed by contractors for their own convenience.

2-934E Work Control

Meetings should be held with the contractor to review the contract requirements and procedures for trafficperson services. All trafficpersons employed on the project must be authorized by the Chief Inspector or Project Engineer.

Trafficpersons are guided only by directions from the Chief Inspector, or a designated assistant, and shall not accept orders from the contractor or contractor's representative while assigned to traffic duty, even though they may be furnished by the contractor. Trafficpersons shall be instructed in the manner of directing traffic and shall never leave the posts to which they are assigned without arranging for relief for the full periods of their absences.

A meeting is held at the beginning of each day or shift to coordinate trafficperson services. The contractor, the Inspector, and the trafficpersons who are on duty that day attend meeting. The contractor's operations and the allowable traffic restrictions in the contract are reviewed. The Inspector advises the trafficpersons of the times of allowable lane closures and the specifications stating that the contractor will provide the services as the Engineer may order.

If at the daily or shift meeting, or during the course of the work, the trafficpersons feel there is a hazard to traffic, they should inform the Inspector immediately so adjustments can be made. The Inspector reviews the problem, and with the District's approval, adjusts the restrictions in the contract for the operation. If the contractor is working on a ramp or turning roadway, the review should be done a minimum of two days in advance. If, in the opinion of the trafficpersons, the work cannot be done safely without closing the ramp or turning roadway, the Inspector notifies the District so that the allowable hours for closure can be established. It is not acceptable for the trafficpersons to shut down ramps, etc., for the contractor's convenience. All changes must be approved by the District prior to implementation.

2-934F Operations

Trafficpersons who are ordered by the Engineer for a particular operation that is deferred because of inclement weather or other unforeseen circumstances are retained at their duty station for the minimum service period.

Chief Inspectors see that trafficpersons are equipped and instructed in accordance with the following regulations:

- Stop-slow paddles are to be used instead of flags. The standard procedure for using paddles to direct traffic is in Figure 2-9.24.
- Only persons who are physically and mentally qualified and who understand their duties and realize their responsibility should be used as a trafficperson. They must be even tempered, decisive, and reliable.
- Trafficpersons should not be allowed to mingle with the workers while on duty or leave their posts without permission.
- The trafficpersons must stand just outside the approaching traffic lane, facing traffic, should be positioned so that the paddle is visible in the traffic lane for a distance of at least 500 ft. (150 m), and should be near enough to the work area so that there can be no doubt as to the purpose. The trafficpersons should not jeopardize personal safety and must be ready to stand clear and warn the workers in case an approaching vehicle does not stop.
- Trafficpersons should always be courteous, but firm, giving explanations about the hazards or delays in a few words. They must not lose their tempers or argue with the traveling public.

2-934G Documentation

See Volume 1, Chapter 20 for guidance on payment protocols for the Trafficperson item. State Police are to be paid by force account as outlined in Section 1-2005. All trafficpersons rendering services authorized or not, should be recorded in the project records. The following information should be documented:

- date,
- name,
- badge number,
- ordered by the Engineer or contractor,

Volume 2

- reason for services,
- duty station,
- function performed,
- arrival and departure times, and
- hours worked.

Reasons for unusual events should be recorded as well.

- If a trafficperson works through the lunch break, record the reason.
- If a trafficperson works outside the contractor's normal working hours, record the reason.
- If, during a day, a trafficperson works on another project before working on your project, record the project from which the trafficperson was transferred.

At least once a month, Project Engineers will check each project under their jurisdiction to verify that records are kept properly.

2-934H Payment

On each project, one inspector is designated to ensure proper payment of the Trafficperson item. The inspector reviews the Daily Reports for accuracy.

Payment is based on the documentation kept by project personnel. The contractor's log is not used. Differences between the Inspector's Reports and the monthly statement or receipted bill for trafficperson services must be investigated fully. Only Trafficperson services approved by the Engineer will be measured by the Engineer.

Refer to Volume 1, Chapter 20 for further guidance.

2-935 Traffic Control During Construction Operations

2-935A General

The following guidelines will assist field personnel in determining when and what type of traffic control patterns to use for various situations. These guidelines provide for the safe and efficient movement of traffic through work zones and enhance the safety of work forces in the work area.

2-935B Traffic Control Patterns

Traffic control patterns shall be used when a work operation requires that all or part of any vehicle or work area protrudes onto any part of a travel lane or shoulder. For each situation, the installation of traffic control devices shall be based on the following:

- Speed and volume of traffic
- Duration of operation
- Exposure to hazards

Traffic control patterns shall be uniform, neat and orderly so as to command respect from the motorist.

In the case of a horizontal or vertical sight restriction in advance of the work area, the traffic control pattern shall be extended to provide adequate sight distance for approaching traffic.

If a lane reduction taper is required to shift traffic, the entire length of the taper should be installed on a tangent section of roadway so that the entire taper area can be seen by the motorist.

Any existing signs that are in conflict with the traffic control patterns shall be removed, covered, or turned so that they are not readable by oncoming traffic.

When installing a traffic control pattern, a Buffer Area should be provided and this area shall be free of equipment, workers, materials and parked vehicles.

Typical traffic control plans 20 through 25 (Figures 2-9.31 through 2-9.36) may be used for moving operations such as line striping, pot hole patching, mowing, or sweeping when it is necessary for equipment to occupy a travel lane.

Traffic control patterns will not be required when vehicles are on an emergency patrol type activity or when a short duration stop is made and the equipment can be contained within the shoulder. Flashing lights and appropriate trafficperson shall be used when required.

Although each situation must be dealt with individually, conformity with the typical traffic control plans contained herein is required. In a situation not adequately covered by the typical traffic control plans, the Contractor must contact the Engineer for assistance prior to setting up a traffic control pattern.

2-935C Placement of Signs

Signs must be placed in such a position to allow motorists the opportunity to reduce their speed prior to the work area. Signs shall be installed on the same side of the roadway as the work area. On multi-lane divided highways, advance warning signs may be installed on both sides of the highway. On directional roadways (on-ramps, off-ramps, one-way roads), where the sight distance to signs is restricted, these signs should be installed on both sides of the roadway.

2-935D Allowable Adjustment of Signs and Devices Shown on the Traffic Control Plans

The traffic control plans contained herein show the location and spacing of signs and devices under ideal conditions. Signs and devices should be installed as shown on these plans whenever possible. The proper application of the traffic control plans and installation of traffic control devices depends on actual field conditions.

Adjustments to the traffic control plans shall be made only at the direction of the Engineer to improve the visibility of the signs and devices and to better control traffic operations. Adjustments to the traffic control plans shall be based on safety of work forces and motorists, abutting property requirements, driveways, side roads, and the vertical and horizontal curvature of the roadway.

The Engineer may require that the traffic control pattern be located significantly in advance of the work area to provide better sight line to the signing and safer traffic operations through the work zone.

Table I indicates the minimum taper length required for a lane closure based on the posted speed limit of the roadway. These taper lengths shall only be used when the recommended taper lengths shown on the traffic control plans cannot be achieved.

Table I – Minimum Taper Lengths

Posted Speed Limit Miles Per Hour	Minimum Taper Length In Feet For A Single Lane Closure
30 OR LESS	180
35	250
40	320
45	540
50	600
55	660
65	780

2-935E Work Zone Safety Meetings

Prior to the commencement of work, a work zone safety meeting will be conducted with representatives of DOT Construction, Connecticut State Police (Local Barracks), Municipal Police, the Contractor (Project Superintendent) and the Traffic Control Subcontractor (if different than the prime Contractor) to review the contract requirements and discuss the Department’s procedures. Other work zone safety meetings during the course of the project should be scheduled as needed.

A Work Zone Safety Meeting Agenda, (see Section 2-934N), shall be developed and used at the meeting to outline the anticipated traffic control issues during the construction of this project. Any issues that can’t be resolved at these meetings will be brought to the attention of the District Engineer and the Office of Construction.

2-935F Installing and Removing Traffic Control Patterns

Lane Closures shall be installed beginning with the advanced warning signs and proceeding forward toward the work area.

Lane Closures shall be removed in the reverse order, beginning at the work area, or end of the traffic control pattern, and proceeding back toward the advanced warning signs.

Stopping traffic may be allowed:

- As per the contract for such activities as blasting, steel erection, etc.
- During paving, milling operations, etc. where, in the middle of the operation, it is necessary to flip the pattern to complete the operation on the other half of the roadway and traffic should not travel across the longitudinal joint or difference in roadway elevation.
- To move slow moving equipment across live traffic lanes into the work area.

Under certain situations when the safety of the traveling public and/or that of the workers may be compromised due to conditions such as traffic volume, speed, roadside obstructions, or sight line deficiencies, as determined by the Engineer and/or State Police, traffic may be briefly impeded while installing and/or removing the advanced warning signs and the first ten traffic cones/drums only. Appropriate measures shall be taken to safely slow traffic. If required, State Police may use traffic slowing techniques, including the use of Truck Mounted Impact Attenuators (TMAs) as appropriate, for a minimum of one mile in advance of the pattern starting point. Once the advanced warning signs and the first ten

traffic cones/drums are installed and/or removed, the two TMAs and sign crew should continue to install or remove the pattern as described in Section 2-934B and traffic shall be allowed to resume their normal travel.

The Contractor must adhere to using the proper signs, placing the signs correctly, and ensuring the proper spacing of signs.

Additional devices are required on entrance ramps, exit ramps, and intersecting roads to warn and/or move traffic into the proper travel path prior to merging/exiting with/from the main line traffic. This shall be completed before installing the mainline pattern past the ramp or intersecting roadway.

Prior to installing a pattern, any conflicting existing signs shall be covered with an opaque material. Once the pattern is removed, the existing signs shall be uncovered.

On limited access roadways, workers are prohibited from crossing the travel lanes to install and remove signs or other devices on the opposite side of the roadway. Any signs or devices on the opposite side of the roadway shall be installed and removed separately.

2-935G Use of High Mounted Internally Illuminated Flashing Arrow

On limited access roadways, one Flashing Arrow shall be used for each lane that is closed. The Flashing Arrow shall be installed concurrently with the installation of the traffic control pattern and its placement shall be as shown on the traffic control plan. For multiple lane closures, one Flashing Arrow is required for each lane closed. If conditions warrant, additional Flashing Arrows should be employed (i.e.: curves, major ramps, etc.).

On non-limited access roadways, the use of a Flashing Arrow for lane closures is optional. The roadway geometry, sight line distance, and traffic volume should be considered in the decision to use the Flashing Arrow.

The Flashing Arrow shall not be used on two lane, two-way roadways for temporary alternating one-way traffic operations.

The Flashing Arrow board display shall be in the “arrow” mode for lane closure tapers and in the “caution” mode (four corners) for shoulder work, blocking the shoulder, or roadside work near the shoulder. The Flashing Arrow shall be in the “caution” mode when it is positioned in the closed lane.

The Flashing Arrow shall not be used on a multi-lane roadway to laterally shift all lanes of traffic, because unnecessary lane changing may result.

If the required number of Flashing Arrows is not available, the traffic control pattern shall not be installed.

2-935H Use of Truck Mounted Impact Attenuator Vehicles (TMAs)

For lane closures on limited access roadways, a minimum of two TMAs shall be used to install and remove traffic control patterns. If two TMAs are not available, the pattern shall not be installed.

On non-limited access roadways, the use of TMAs to install and remove patterns closing a lane(s) is optional. The roadway geometry, sight line distance, and traffic volume should be considered in the decision to utilize the TMAs.

Generally, to establish the advance and transition signing, one TMA shall be placed on the shoulder and the second TMA shall be approximately 1,000 feet ahead blocking the lane. The flashing arrow board mounted on the TMA should be in the “flashing arrow” mode when taking the lane. The sign truck and workers should be immediately ahead of the second TMA. In no case shall the TMA be used as the sign truck or a work truck. Once the transition is in place, both TMAs shall travel in the closed lane until all Changeable Message Signs, signs, Flashing Arrows, and cones/drums are installed. The flashing arrow board mounted on the TMA should be in the “caution” mode when traveling in the closed lane.

A TMA shall be placed prior to the first work area in the pattern. If there are multiple work areas within the same pattern, then additional TMAs may be positioned at each additional work area as needed. The flashing arrow board mounted on the TMA should be in the “caution” mode when in the closed lane.

TMAs shall be positioned a sufficient distance prior to the workers or equipment being protected to allow for appropriate vehicle roll-ahead in the event that the TMA is hit, but not so far that an errant vehicle could travel around the TMA and into the work area. For additional placement and use details, refer to the specification entitled “Type ‘D’ Portable Impact Attenuation System”. Some operations, such as paving and concrete repairs, do not allow for placement of the TMA(s) within the specified distances. In these situations, the TMA(s) should be placed at the beginning of the work area and shall be advanced as the paving or concrete operations proceed.

TMAs should be paid in accordance with how the unit is utilized. When it is used as a TMA and is in the proper location as specified, then it should be paid at the specified hourly rate for “Type ‘D’ Portable Impact Attenuation System”. When the TMA is used as a Flashing Arrow, it should be paid at the daily rate for “High Mounted Internally Illuminated Flashing Arrow”. If a TMA is used to install and remove a pattern and then is used as a Flashing Arrow, the unit should be paid as a “Type ‘D’ Portable Impact Attenuation System” for the hours used to install and remove the pattern, typically 2 hours (1 hour to install and 1 hour to remove), and is also paid for the day as a “High Mounted Internally Illuminated Flashing Arrow”.

If the required number of TMAs is not available, the pattern shall not be installed.

2-935I Use of State Police Officers

State Police may be utilized only on limited access highways and secondary roadways under their primary jurisdiction. At least one Officer should be used per critical sign pattern. Shoulder closures and right lane closures can generally be implemented without the presence of a State Police Officer. Likewise in areas with moderate traffic and wide, unobstructed medians, left lane closures can be implemented without State Police presence. Certain situations may require State Police presence, if one is available, even though the general guidelines above indicate otherwise. Examples of this include: nighttime lane closures; left lane closures with minimal width for setting up advance signs and staging; lane and shoulder closures on turning roadways/ramps or mainline where sight distance is minimal; and closures where extensive turning movements or traffic congestion regularly occur.

Once the pattern is in place, the State Police Officer should be positioned in a non-hazardous location at the beginning of the pattern or at one of the work areas not protected by a TMA. If traffic backs up beyond the beginning of the pattern, then the State Police Officer should be repositioned prior to the backup to give warning to the oncoming motorists. Where State Police Officer and TMA are in close proximity to each other, the TMA should be placed to protect the State Police Officer’s vehicle from oncoming traffic.

Other functions of the State Police Officer(s) shall include:

- Assisting entering/exiting construction vehicles within the work area*.

- Enhancing worker visibility/safety for workers in close proximity to the open travel lane(s)*.
- Speed control of traffic within the work area.
- Enforcement of speed and other motor vehicle laws within the work area.

Typically, the State Police Officer should be out of the vehicle for the functions marked with an asterisk (*).

2-935J Use of (Remote Controlled) Changeable Message Signs

For lane closures on limited access roadways, one Changeable Message Sign shall be used in advance of the traffic control pattern. Prior to installing the pattern, the Changeable Message Sign shall be installed and in operation, displaying the appropriate lane closure information (i.e.: Left Lane Closed - Merge Right). The Changeable Message Sign shall be positioned ½ - 1 mile ahead of the lane closure taper. If the nearest Exit ramp is greater than the specified ½ - 1 mile distance, than an additional Changeable Message Sign shall be positioned a sufficient distance ahead of the Exit ramp to alert motorists to the work and therefore offer them an opportunity to take the exit.

On non-limited access roadways, the use of Changeable Message Signs for lane closures is optional. The roadway geometry, sight line distance, and traffic volume should be considered in the decision to use the Changeable Message Sign.

The advance Changeable Message Sign is typically placed off the right shoulder, 5 feet from the edge of pavement. In areas where the Changeable Message Sign cannot be placed beyond the edge of pavement, it may be placed on the paved shoulder with a minimum of five (5) traffic drums placed in a taper in front of it to delineate its position. The advance Changeable Message Sign shall be adequately protected if it is used for a continuous duration of 36 hours or more.

When the Changeable Message Signs are no longer required, they should be removed from the clear zone and have the display screen cleared and turned 90° away from the roadway.

The Changeable Message Sign generally should not be used for generic messages (ex: Road Work Ahead, Bump Ahead, Gravel Road, etc.).

The Changeable Message Sign should be used for specific situations that need to command the motorist's attention which cannot be conveyed with standard construction signs (Examples include: Exit 34 Closed Sat/Sun - Use Exit 35, All Lanes Closed - Use Shoulder, Workers on Road - Slow Down).

Messages that need to be displayed for long periods of time, such as during stage construction, should be displayed with construction signs. For special signs, please coordinate with the Office of Construction and the Division of Traffic Engineering for the proper layout/dimensions required.

Section 2-9340 contains the messages that are allowed on the Changeable Message Sign. For any other message(s), approval must be received from the Office of Construction prior to their use. No more than two (2) displays shall be used within any message cycle.

If the required number of Changeable Message Signs is not available, the pattern shall not be installed.

2-935K Use of (Remote Control) Changeable Message Signs With Radar

(Remote Control) Changeable Message Signs with Radar shall be used when specified, or as directed by the Engineer.

Volume 2

The typical placement of a (Remote Control) Changeable Message Sign with Radar is in the work zone portion of the traffic control pattern.

The typical usage of the (Remote Control) Changeable Message Sign with Radar is to display a message when a preset speed is exceeded. The sign will blank when no vehicles are present.

The preset speed for activating the message should be set 5-10 MPH above the posted, or desired, speed.

Section 2-934O contains the messages that are allowed on the (Remote Controlled) Changeable Message Sign with Radar. For any other message(s), approval must be received from the Office of Construction prior to their use. No more than two (2) displays shall be used within any message cycle.

2-935L Use of Traffic Drums and Traffic Cones

Traffic drums shall be used for taper channelization on limited-access roadways, ramps, and turning roadways and to delineate raised catch basins and other hazards.

Traffic drums shall be used in place of traffic cones in traffic control patterns that are in effect for more than a 72-hour duration.

Traffic Cones less than 42 inches in height shall not be used on limited-access roadways or on non-limited access roadways with a posted speed limit of 45 mph and above.

Typical spacing of traffic drums and/or cones shown on the Traffic Control Plans in the Contract are maximum spacing and may be reduced to meet actual field conditions as required.

2-935M General Requirements for Traffic Control

If the required minimum number of signs and equipment (i.e. one High Mounted Internally Illuminated Flashing Arrow for each lane closed, two TMAs, Changeable Message Sign, etc.) are not available, the traffic control pattern shall not be installed.

The Contractor shall have back-up equipment (TMAs, High Mounted Internally Illuminated Flashing Arrow, Changeable Message Sign, construction signs, cones/drums, etc.) available at all times in case of mechanical failures, etc. The only exception to this is in the case of sudden equipment breakdowns in which the pattern may be installed but the Contractor must provide replacement equipment within 24 hours.

Failure of the Contractor to have the required minimum number of signs and equipment, which results in their not being installed, shall not be a reason for a time extension.

In cases of legitimate differences of opinion between the Contractor and the Inspection staff, the Inspection staff shall err on the side of safety. The matter shall be brought to the District Office for resolution immediately or, in the case of work after regular business hours, on the next business day.

2-935N Work Zone Safety Meeting Agenda

- 1) Review Project scope of work and time.
- 2) Review Article 1.08, Prosecution and Progress of the Special Provisions.
- 3) Review Article 9.70, Trafficperson of the Specifications.

- 4) Review Article 9.71, Maintenance and Protection of Traffic of the Special Provisions, including “Work Zone Safety Procedures”.
- 5) Review Contractor’s schedule and method of operations.
- 6) Review areas of special concern: ramps, turning roadways, medians, lane drops, etc.
- 7) Open discussion of work zone questions and issues.
- 8) Discussion of review and approval process for changes in contract requirements as they relate to work zone areas.

2-9350 Work Zone Safety Procedures - Allowable Messages for Changeable Message Signs

<u>Message No.</u>	<u>Frame 1</u>	<u>Frame 2</u>	<u>Message No.</u>	<u>Frame 1</u>	<u>Frame 2</u>
1	LEFT LANE CLOSED	MERGE RIGHT	9	LANES CLOSED AHEAD	REDUCE SPEED
2	2 LEFT LANES CLOSED	MERGE RIGHT	10	LANES CLOSED AHEAD	USE CAUTION
3	LEFT LANE CLOSED	REDUCE SPEED	11	WORKERS ON ROAD	REDUCE SPEED
4	2 LEFT LANES CLOSED	REDUCE SPEED	12	WORKERS ON ROAD	SLOW DOWN
5	RIGHT LANE CLOSED	MERGE LEFT	13	EXIT XX CLOSED	USE EXIT YY
6	2 RIGHT LANES CLOSED	MERGE LEFT	14	EXIT XX CLOSED USE YY	FOLLOW DETOUR
7	RIGHT LANE CLOSED	REDUCE SPEED	15	2 LANES SHIFT AHEAD	USE CAUTION
8	2 RIGHT LANES CLOSED	REDUCE SPEED	16	3 LANES SHIFT AHEAD	USE CAUTION

Figure 2-9.10 Traffic Control Plan Series 16 Signs

SERIES 16 SIGNS

		W	H
16-E	80-1605	84"	60"
16-H	80-1608	60"	42"
16-M	80-1613	30"	24"

		W	H
16-S	80-1619	48"	30"

THE 16-S SIGN SHALL BE USED ON ALL PROJECTS THAT REQUIRE SIDEWALK RECONSTRUCTION OR RESTRICT PEDESTRIAN TRAVEL ON AN EXISTING SIDEWALK.

SERIES 16 SIGNS SHALL BE INSTALLED IN ADVANCE OF THE TRAFFIC CONTROL PATTERNS TO ALLOW MOTORISTS THE OPPORTUNITY TO AVOID A WORK ZONE. SERIES 16 SIGNS SHALL BE INSTALLED ON ANY MAJOR INTERSECTING ROADWAYS THAT APPROACH THE WORK ZONE. ON LIMITED- ACCESS HIGHWAYS, THESE SIGNS SHALL BE LOCATED IN ADVANCE OF THE NEAREST UPSTREAM EXIT RAMP AND ON ANY ENTRANCE RAMP PRIOR TO OR WITHIN THE WORK ZONE LIMITS.

THE LOCATION OF SERIES 16 SIGNS CAN BE FOUND ELSEWHERE IN THE PLANS OR INSTALLED AS DIRECTED BY THE ENGINEER.

SIGNS 16-E AND 16-H SHALL BE POST MOUNTED.

SIGN 16-E SHALL BE USED ON ALL EXPRESSWAYS.

SIGN 16-H SHALL BE USED ON ALL RAMP, OTHER STATE ROADWAYS, AND MAJOR TOWN/CITY ROADWAYS.

SIGN 16-M SHALL BE USED ON OTHER TOWN ROADWAYS.

REGULATORY SIGN "ROAD WORK AHEAD, FINES DOUBLED"

THE REGULATORY SIGN "ROAD WORK AHEAD, FINES DOUBLED" SHALL BE INSTALLED FOR ALL WORK ZONES THAT OCCUR ON ANY STATE HIGHWAY IN CONNECTICUT WHEN THERE ARE WORKERS ON THE HIGHWAY OR WHEN THERE IS OTHER THAN EXISTING TRAFFIC OPERATIONS. THE "ROAD WORK AHEAD, FINES DOUBLED" REGULATORY SIGNS SHALL NOT BE INSTALLED ON TOWN ROADS.

THE "ROAD WORK AHEAD FINES DOUBLED" REGULATORY SIGN SHALL BE PLACED AFTER THE SERIES 16 SIGN AND IN ADVANCE OF THE "ROAD WORK AHEAD" SIGN.

		W	H
31-1806		48"	42"

"END ROAD WORK" SIGN

THE LAST SIGN IN THE PATTERN MUST BE THE "END ROAD WORK" SIGN.

80-9612

REV'D 1-02

CONNECTICUT
DEPARTMENT OF TRANSPORTATION
BUREAU OF ENGINEERING &
HIGHWAY OPERATIONS
DIVISION OF TRAFFIC ENGINEERING

CONSTRUCTION
TRAFFIC CONTROL PLAN
REQUIRED SIGNS

APPROVED J. Carey DATE 1-02
PRINCIPAL ENGINEER

Figure 2-9.11 Traffic Control Plan Notes (Construction)

NOTES FOR TRAFFIC CONTROL PLANS

1. IF A TRAFFIC STOPPAGE OCCURS IN ADVANCE OF SIGN (A), THEN AN ADDITIONAL SIGN (A) SHALL BE INSTALLED IN ADVANCE OF THE STOPPAGE.
2. SIGNS (AA), (A) AND (D) SHOULD BE OMITTED WHEN THESE SIGNS HAVE ALREADY BEEN INSTALLED TO DESIGNATE A LARGER WORK ZONE THAN THE WORK ZONE THAT IS ENCOMPASSED ON THIS PLAN.
3. SEE TABLE #1 FOR ADJUSTMENT OF TAPERS IF NECESSARY.
4. A CHANGEABLE MESSAGE SIGN MAY BE UTILIZED ONE HALF TO ONE MILE IN ADVANCE OF THE LANE CLOSURE TAPER.
5. IF THIS PLAN REMAINS IN CONTINUOUS OPERATION FOR MORE THAN 72 HOURS, THEN TRAFFIC DRUMS SHALL BE USED IN PLACE OF TRAFFIC CONES.
6. ANY LEGAL SPEED LIMIT SIGNS WITHIN THE LIMITS OF A ROADWAY / LANE CLOSURE AREA WILL BE COVERED WITH AN OPAQUE MATERIAL WHILE THE CLOSURE IS IN EFFECT AND UNCOVERED WHEN THE ROADWAY / LANE CLOSURE IS REOPENED TO ALL LANES OF TRAFFIC.
7. IF THIS PLAN REMAINS IN CONTINUOUS OPERATION FOR MORE THAN 36 HOURS, THEN THE EXISTING CONFLICTING PAVEMENT MARKINGS SHALL BE ERADICATED OR COVERED AND TEMPORARY PAVEMENT MARKINGS THAT DEPICT THE PROPER TRAVELPATHS SHALL BE INSTALLED.
8. DISTANCES BETWEEN SIGNS IN THE ADVANCE WARNING AREA MAY BE REDUCED TO 200' ON LOW SPEED URBAN ROADS (SPEED LIMIT < 40 MPH).
9. FOR LANE CLOSURES ONE (1) MILE OR LONGER, A "REDUCE SPEED TO 45 MPH" SIGN SHALL BE PLACED AT THE ONE MILE POINT AND AT EACH MILE THEREAFTER.
10. IF THIS PLAN IS TO REMAIN IN OPERATION DURING THE HOURS OF DARKNESS, INSTALL BARRICADE WARNING LIGHTS - HIGH INTENSITY ON ALL POST-MOUNTED DIAMOND SIGNS IN THE ADVANCE WARNING AREA.
11. A CHANGEABLE MESSAGE SIGN SHALL BE INSTALLED ONE HALF TO ONE MILE IN ADVANCE OF THE LANE CLOSURE TAPER.

REV'D 1-02 

CONNECTICUT DEPARTMENT OF TRANSPORTATION BUREAU OF ENGINEERING & HIGHWAY OPERATIONS DIVISION OF TRAFFIC ENGINEERING
CONSTRUCTION TRAFFIC CONTROL PLAN NOTES

NOTES:004

Figures 2-9.12 Traffic Control Plan 1
Work in Right Lane—Multilane Highway

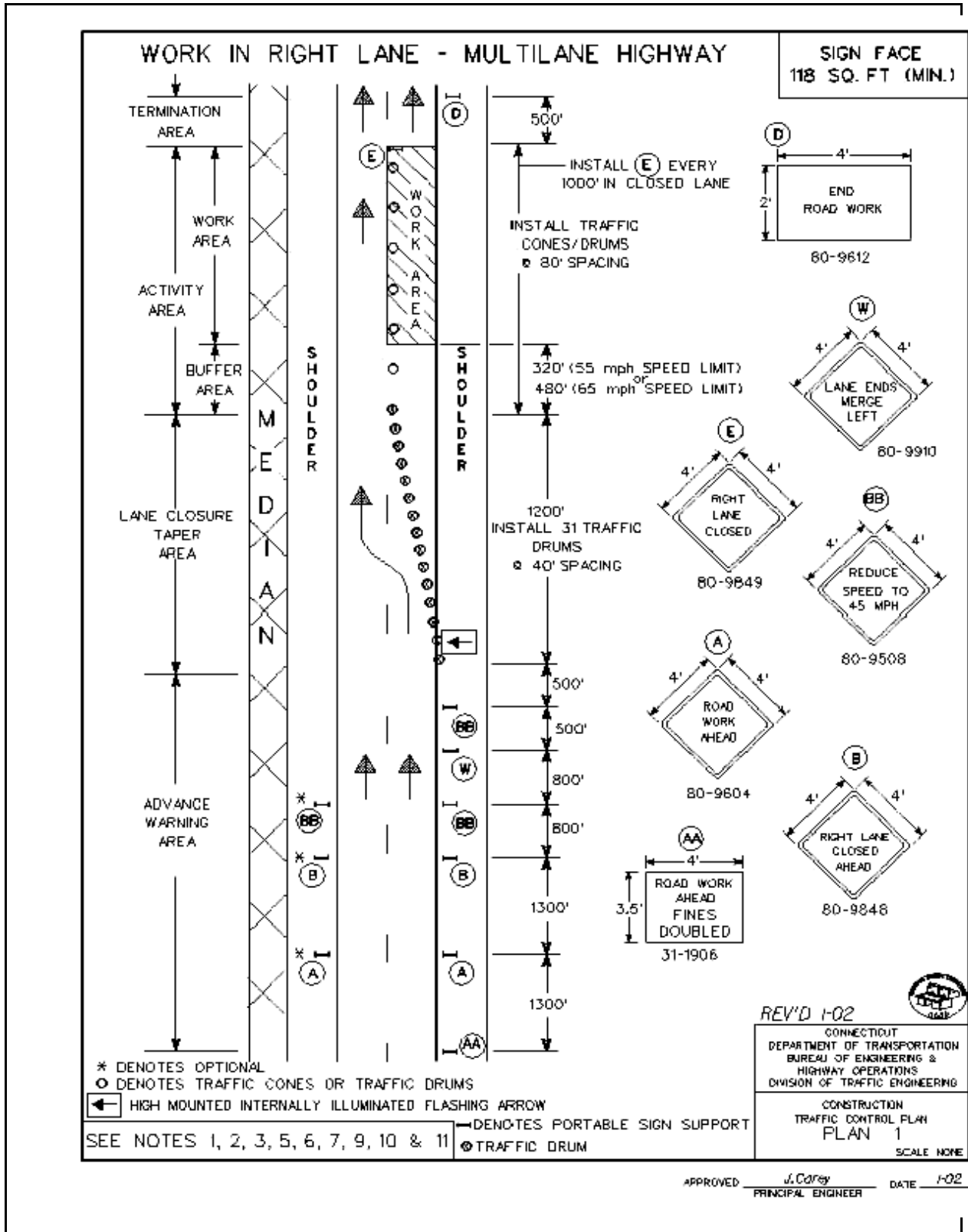

Figure 2-9.13 Traffic Control Plan 2
Work in Right Two Lanes—Multilane Highway

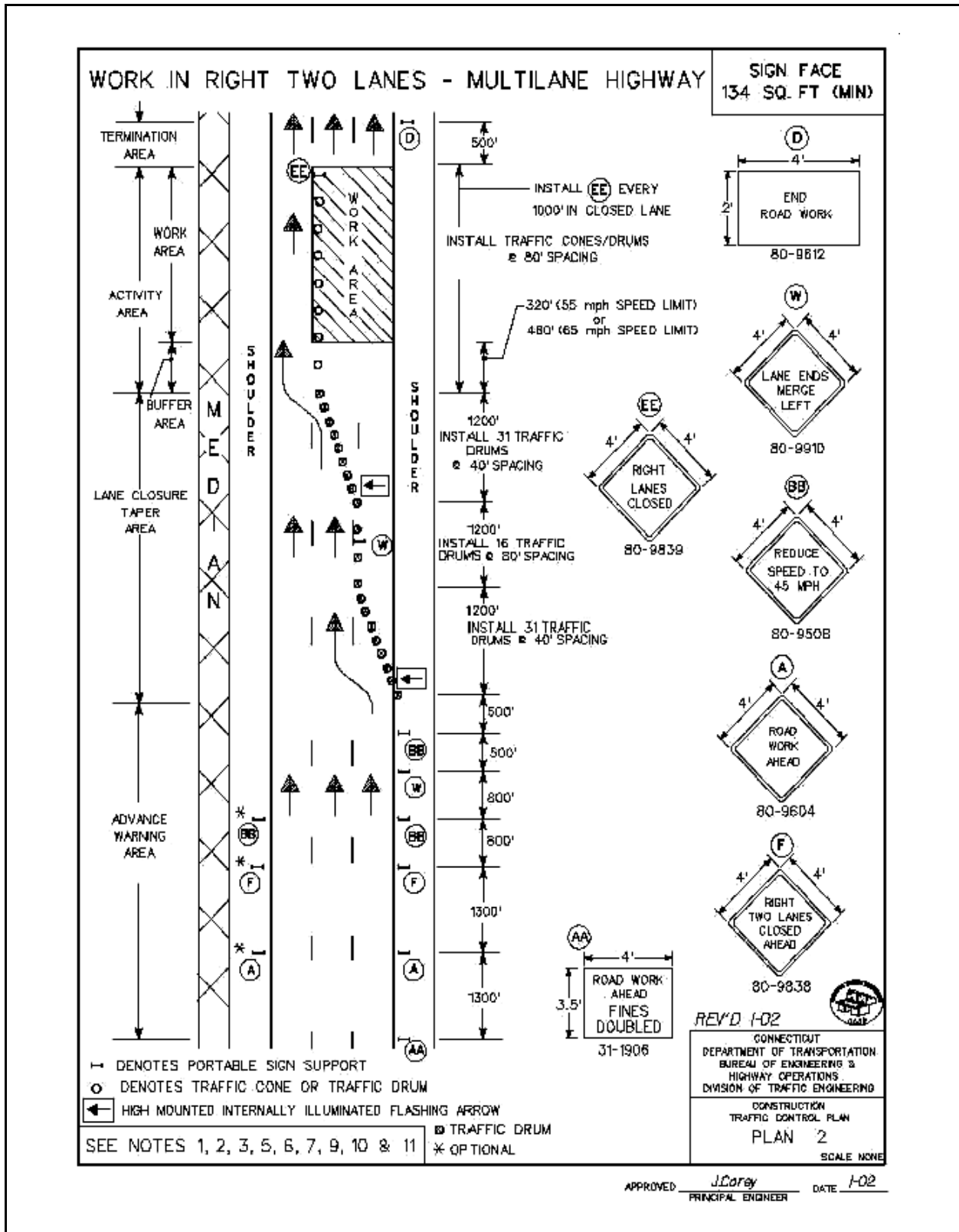

Figure 2-9.14 Traffic Control Plan 3
Work in Left Lane—Multilane Highway

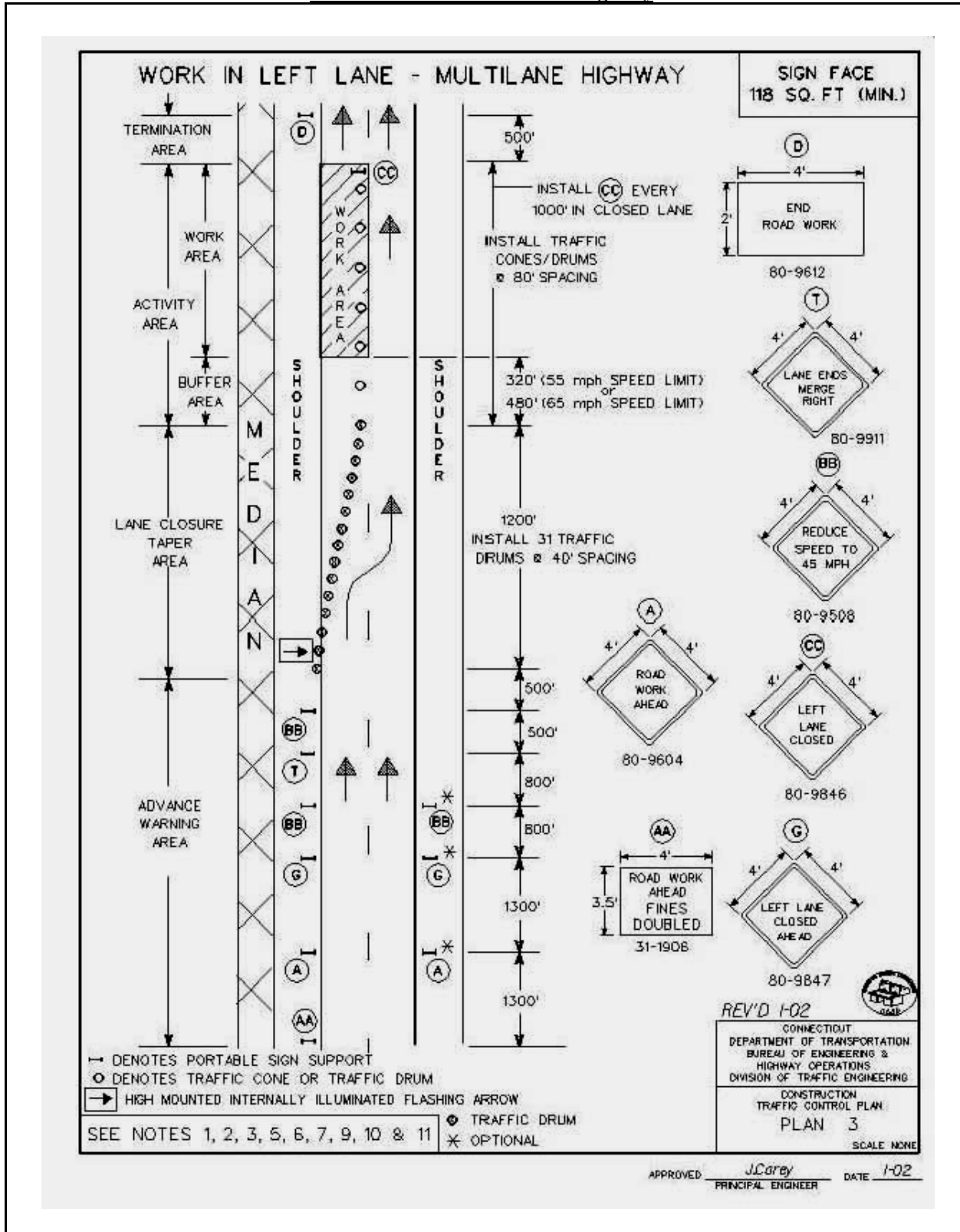

Figure 2-9.15 Traffic Control Plan 4
Work in Left Two Lanes—Multilane Highway

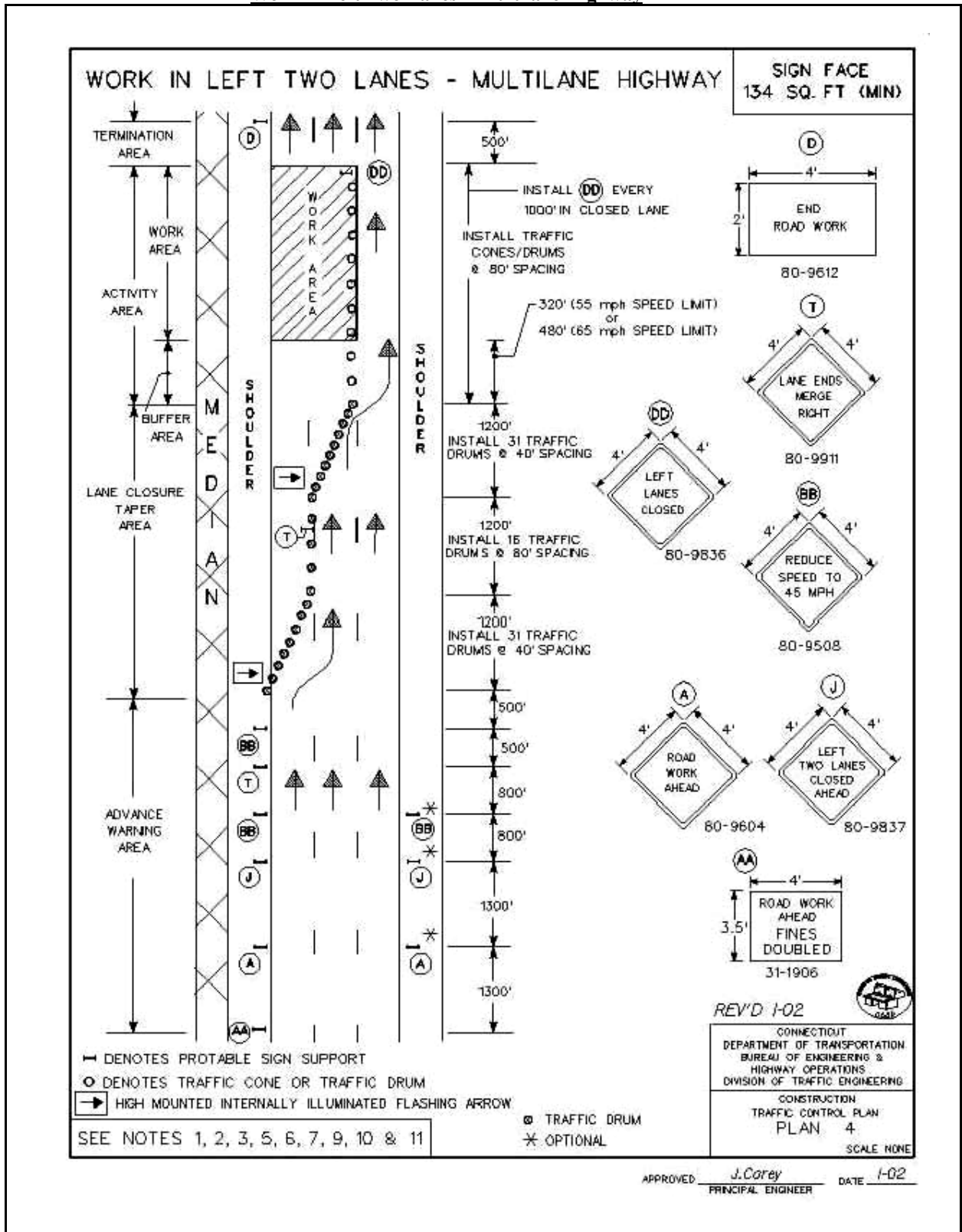

Figure 2-9.16 Traffic Control Plan 5
Work in Left and Center Lane—Multilane Highway (Utilizing Shoulder)

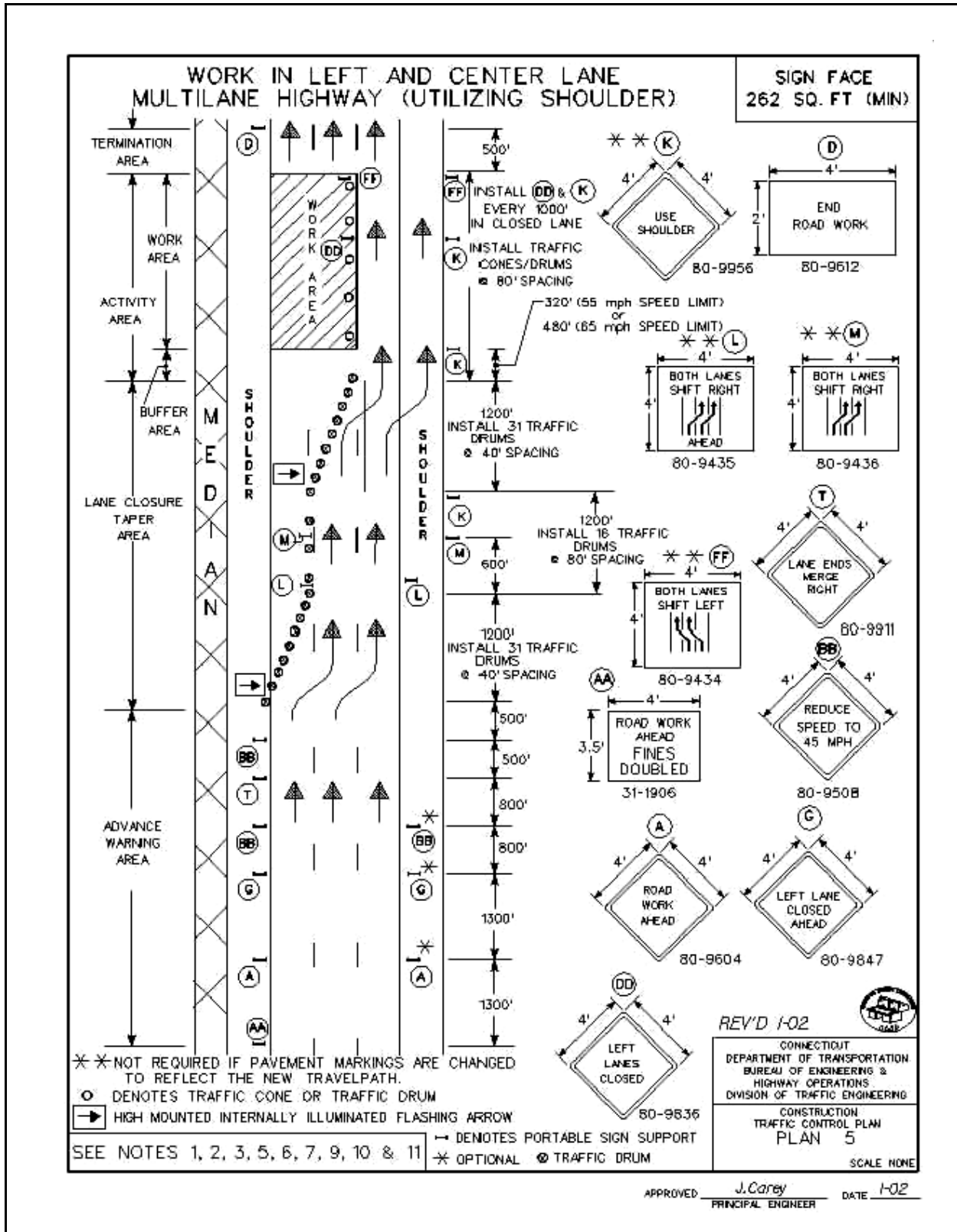

Figure 2-9.17 Traffic Control Plan 6
Work in Shoulder Area—Multilane Highway

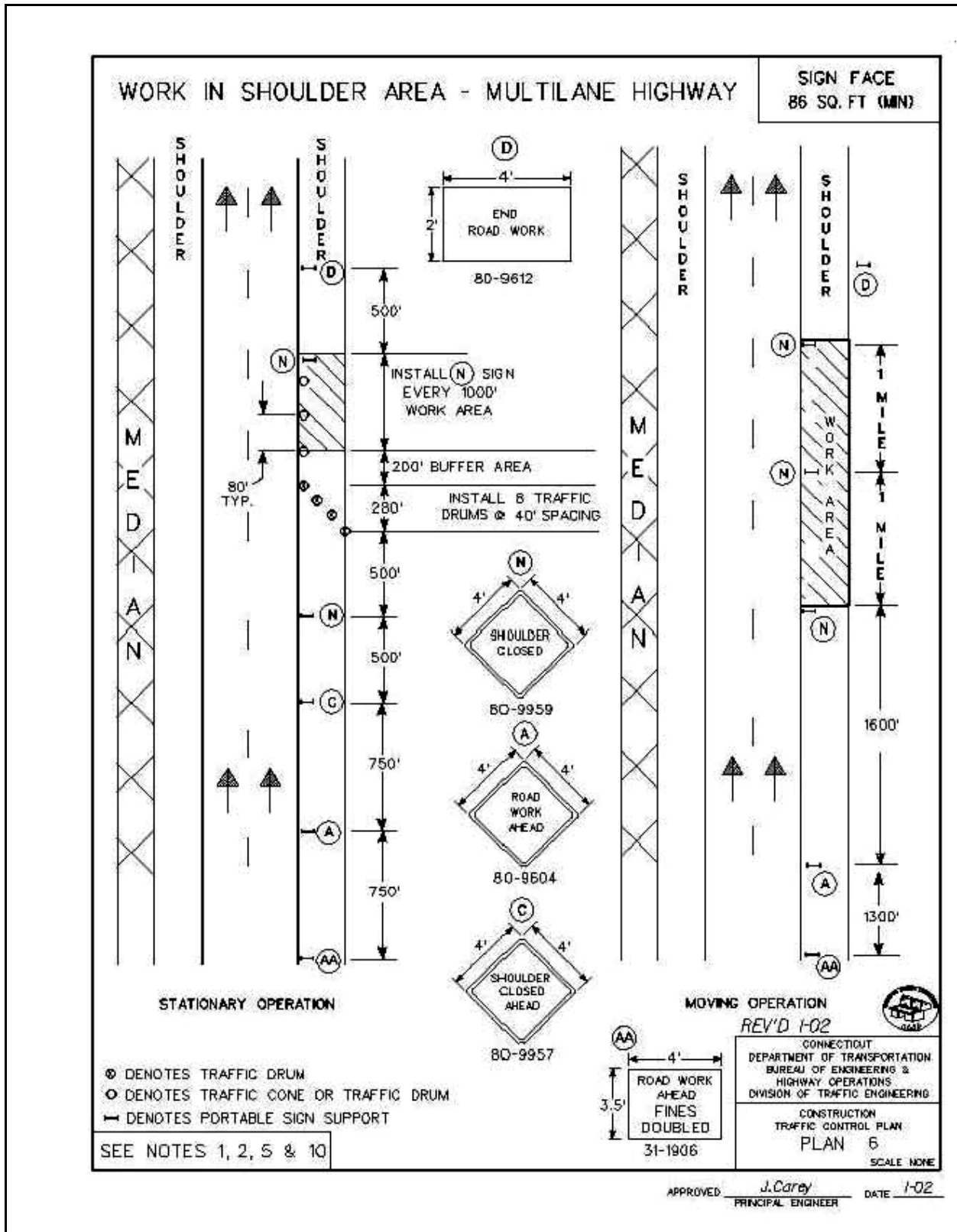

Figure 2-9.18 Traffic Control Plan 7
Work in Ramp Gore Area

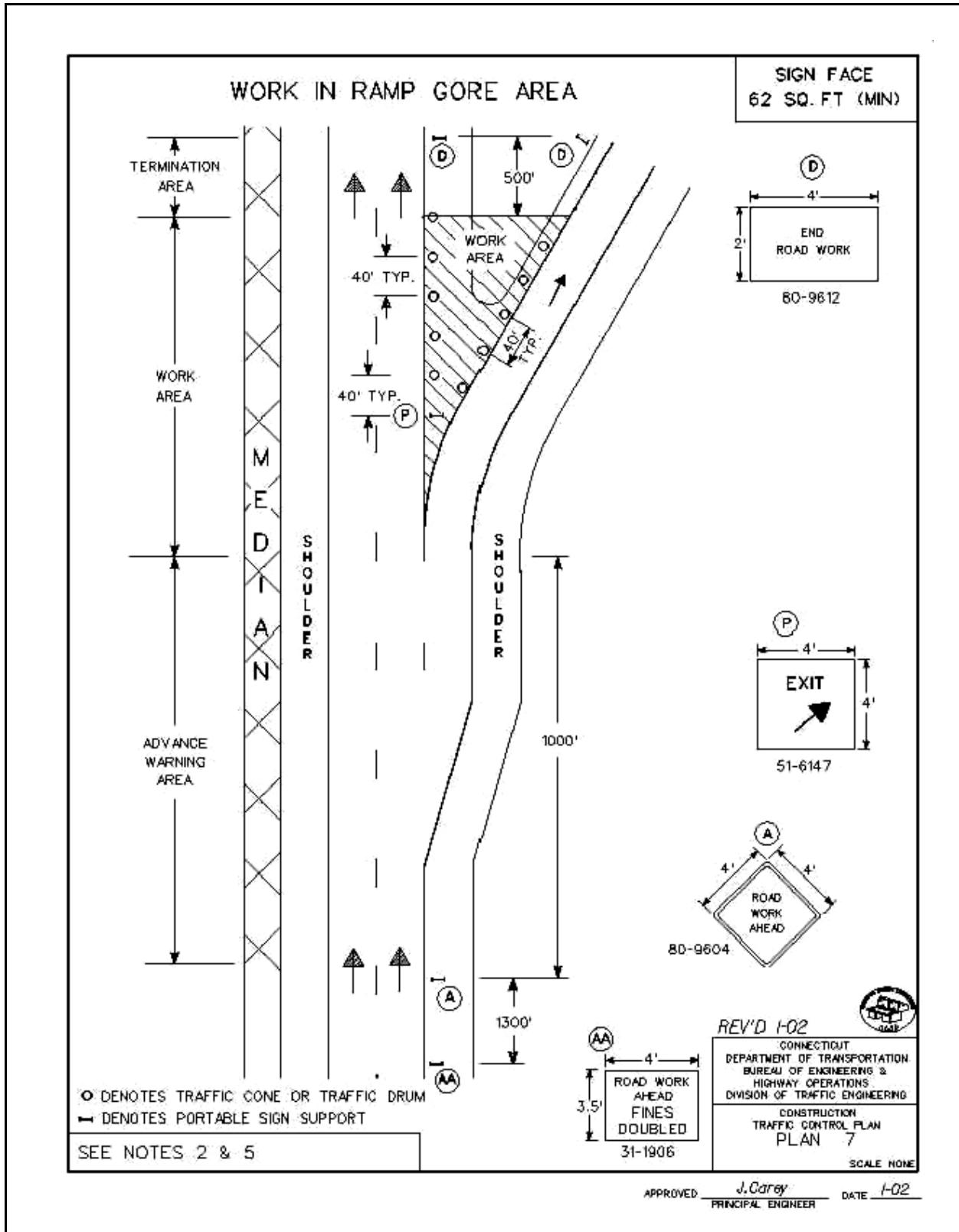

Figure 2-9.19 Traffic Control Plan 8
Typical Ramp Treatments for Mainline Lane Closure—Multilane Highway

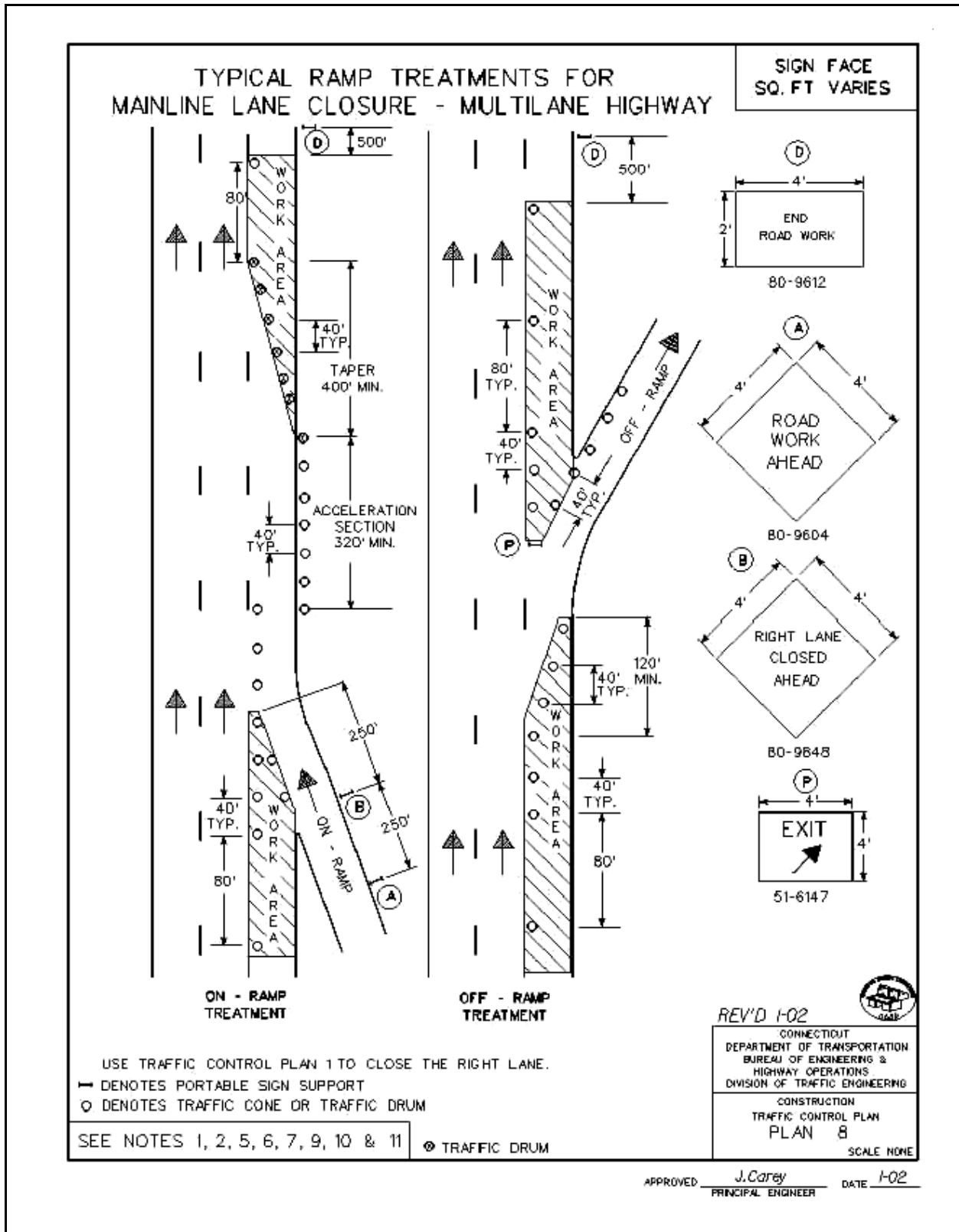

Figure 2-9.20 Traffic Control Plan 9
Work on Turning Roadways/Ramps

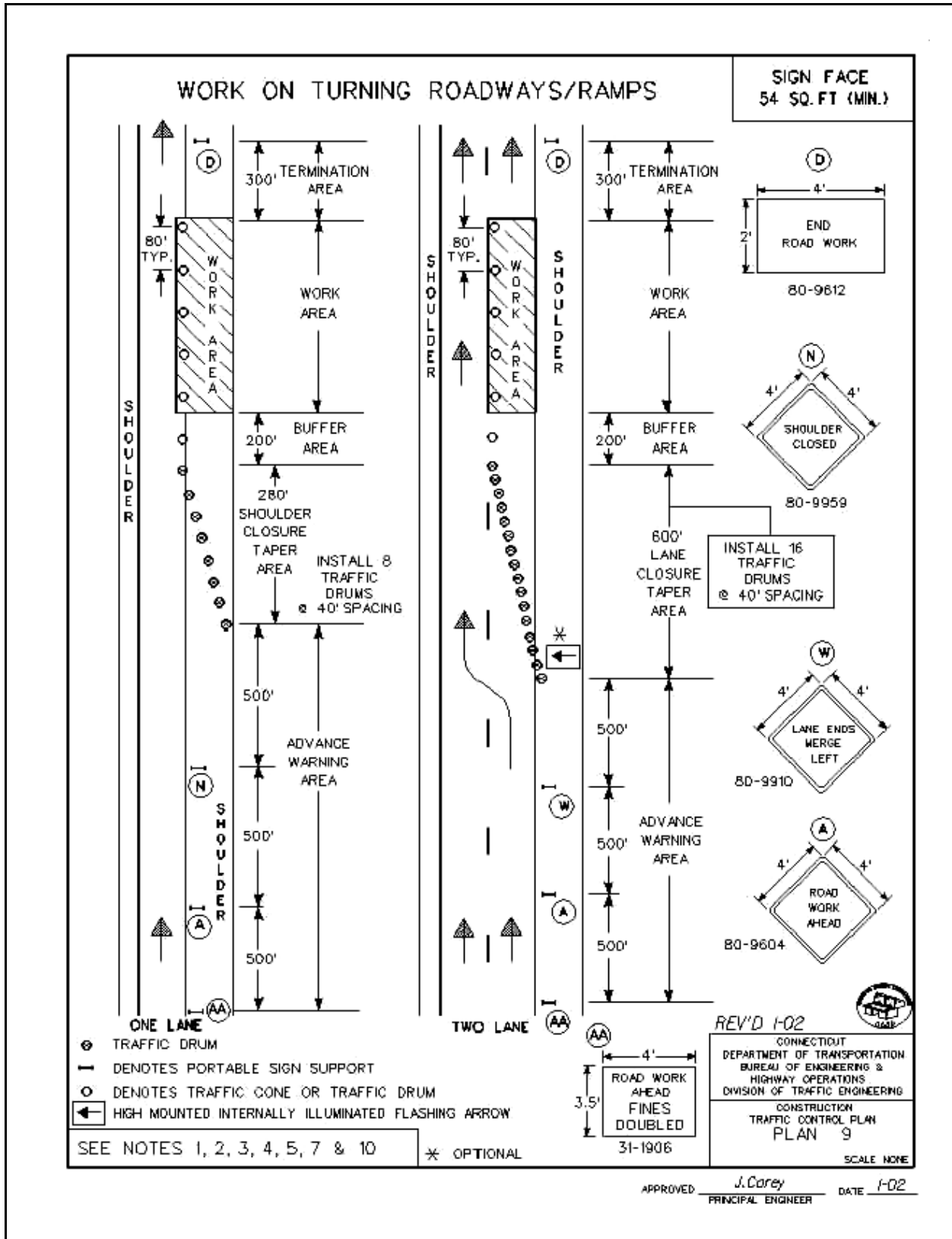

Figure 2-9.22 Traffic Control Plan 11
Work in Left Lane—Four-Lane Undivided Highway

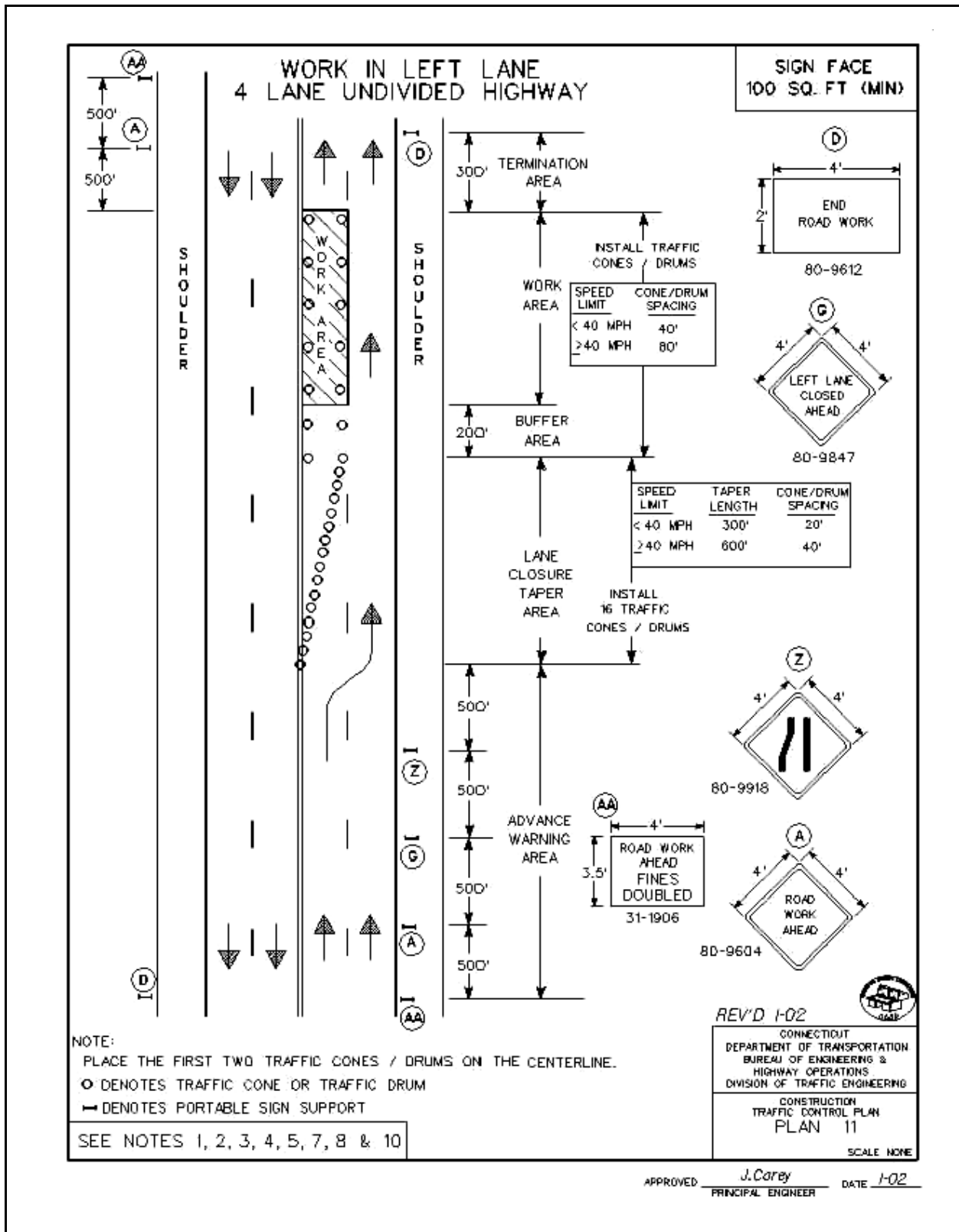

Figure 2-9.24 Traffic Control Plan 13
Work in Travel Lane and Shoulder—Two-Lane Highway
Alternating One-Way Traffic Operations

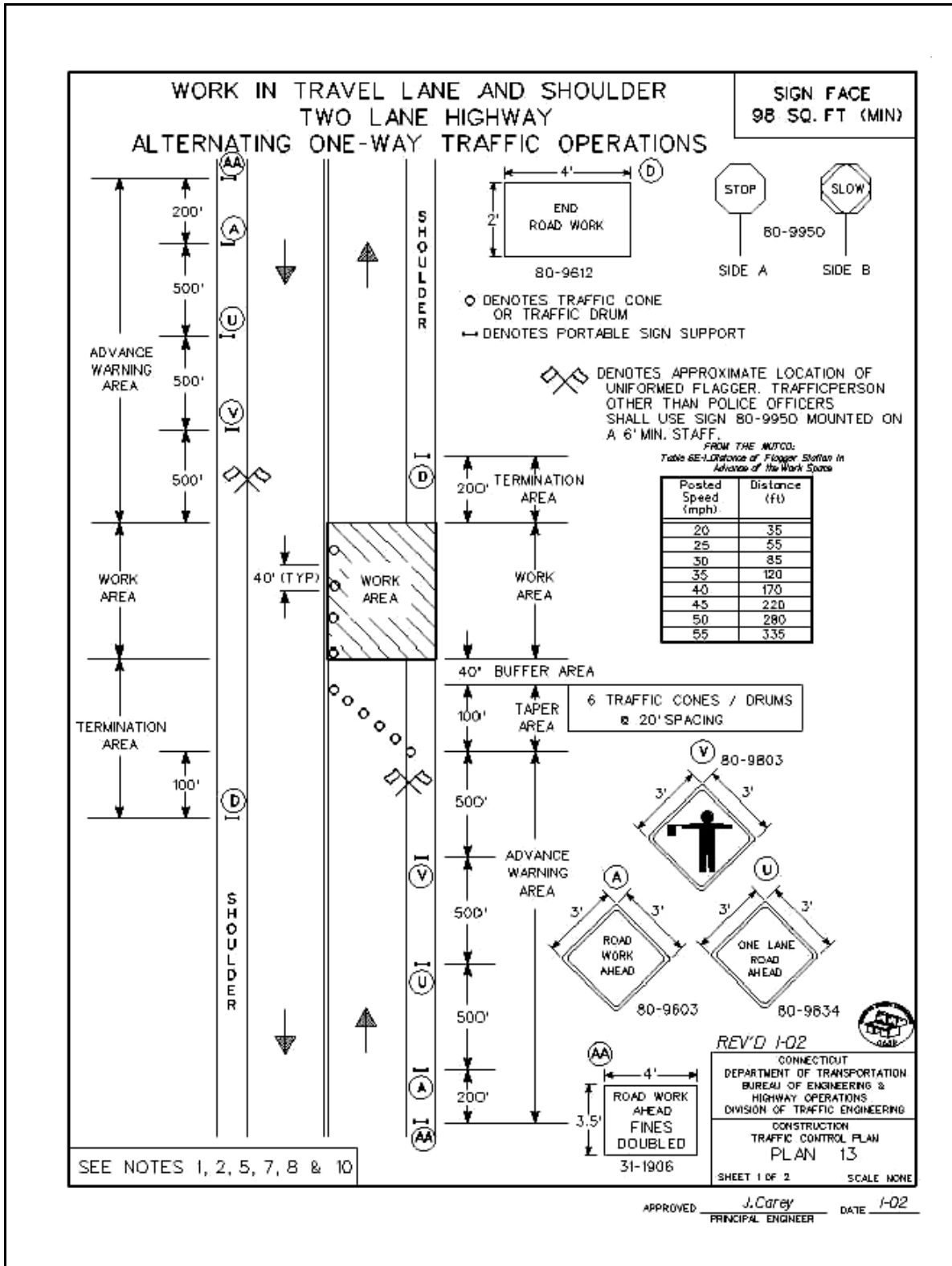

Figure 2-9.24 Traffic Control Plan 13 (continued)
Work in Travel Lane and Shoulder—Two-Lane Highway

**WORK IN TRAVEL LANE AND SHOULDER
TWO LANE HIGHWAY
ALTERNATING ONE-WAY TRAFFIC OPERATIONS**

HAND SIGNAL METHODS TO BE USED BY UNIFORMED FLAGGERS

THE FOLLOWING METHODS FROM SECTION 6E.04 FLAGGER PROCEDURES IN THE "MANUAL ON UNIFORM TRAFFIC CONTROL DEVICES" SHALL BE USED BY UNIFORMED FLAGGERS WHEN DIRECTING TRAFFIC THROUGH A WORK AREA. THE STOP/SLOW SIGN PADDLE (SIGN NO. 80-9950) SHOWN ON THE TYPICAL DETAIL SHEET ENTITLED "SIGNS FOR CONSTRUCTION AND PERMIT OPERATIONS" SHALL BE USED.

A. TO STOP TRAFFIC

TO STOP ROAD USERS, THE FLAGGER SHALL FACE ROAD USERS AND AIM THE STOP PADDLE FACE TOWARD ROAD USERS IN A STATIONARY POSITION WITH THE ARM EXTENDED HORIZONTALLY AWAY FROM THE BODY. THE FREE ARM SHALL BE HELD WITH THE PALM OF THE HAND ABOVE SHOULDER LEVEL TOWARD APPROACHING TRAFFIC.

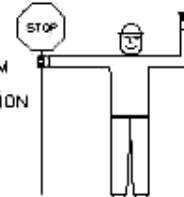

B. TO DIRECT TRAFFIC TO PROCEED

TO DIRECT STOPPED ROAD USERS TO PROCEED, THE FLAGGER SHALL FACE ROAD USERS WITH THE SLOW PADDLE FACE AIMED TOWARD ROAD USERS IN A STATIONARY POSITION WITH THE ARM EXTENDED HORIZONTALLY AWAY FROM THE BODY. THE FLAGGER SHALL MOTION WITH THE FREE HAND FOR ROAD USERS TO PROCEED.

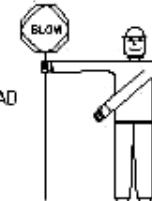

C. TO ALERT OR SLOW TRAFFIC

TO ALERT OR SLOW TRAFFIC, THE FLAGGER SHALL FACE ROAD USERS WITH THE SLOW PADDLE FACE AIMED TOWARD ROAD USERS IN A STATIONARY POSITION WITH THE ARM EXTENDED HORIZONTALLY AWAY FROM THE BODY. TO FURTHER ALERT OR SLOW TRAFFIC, THE FLAGGER HOLDING THE SLOW PADDLE FACE TOWARD ROAD USERS MAY MOTION UP AND DOWN WITH THE FREE HAND, PALM DOWN.

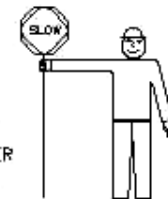

SEE NOTES 1, 2, 5, 7, 8 & 10

REV'D 1-02



CONNECTICUT
DEPARTMENT OF TRANSPORTATION
BUREAU OF ENGINEERING &
HIGHWAY OPERATIONS
DIVISION OF TRAFFIC ENGINEERING

CONSTRUCTION
TRAFFIC CONTROL PLAN
PLAN 13

SHEET 2 OF 2 SCALE NONE

APPROVED: J. Carey DATE 1-02
PRINCIPAL ENGINEER

Figure 2-9.26 Traffic Control Plan 15
Work in Travel Lane and Shoulder—Two-Lane Highway

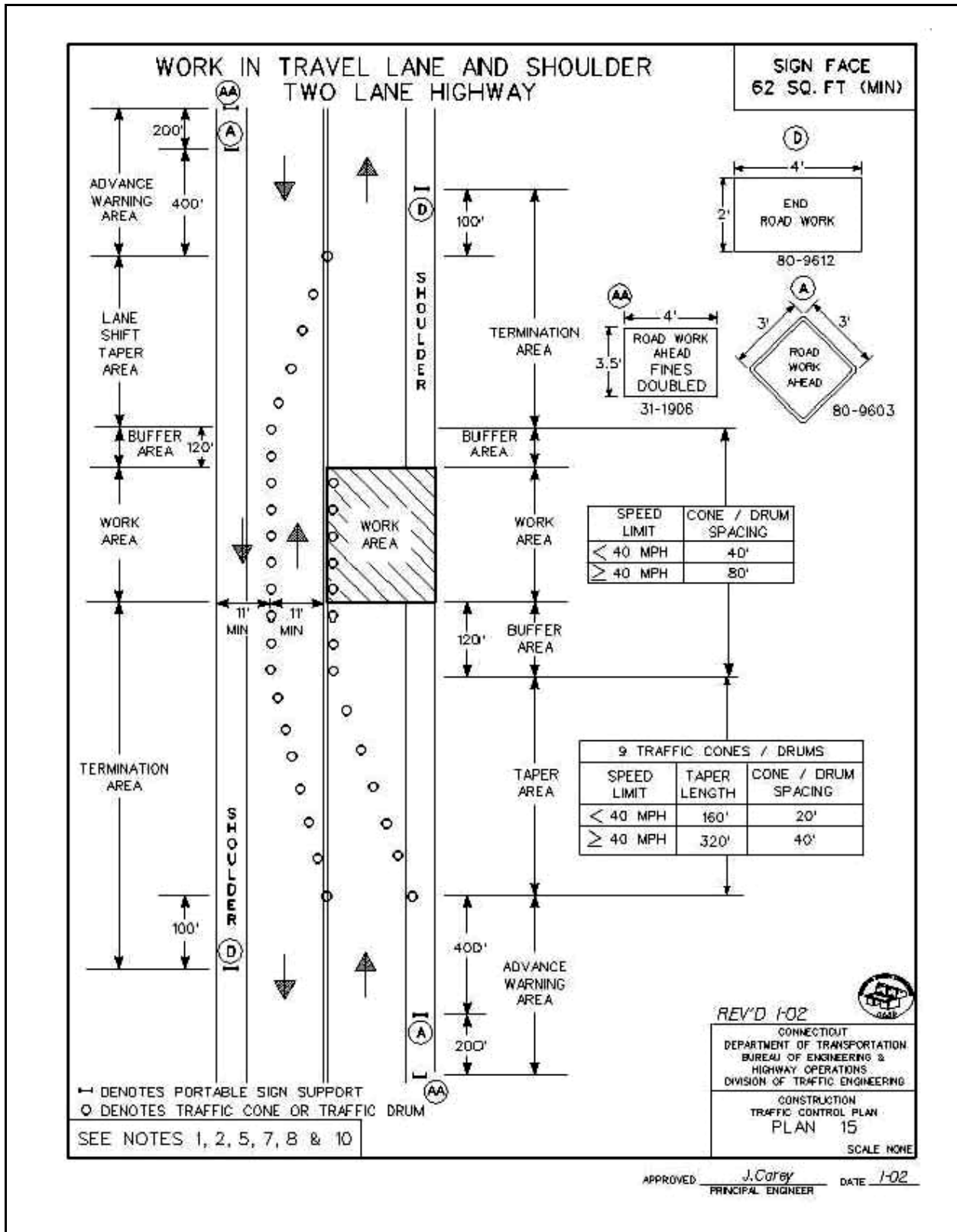

Figure 2-9.27 Traffic Control Plan 16
Work in Middle of Roadway—Two-Lane Highway

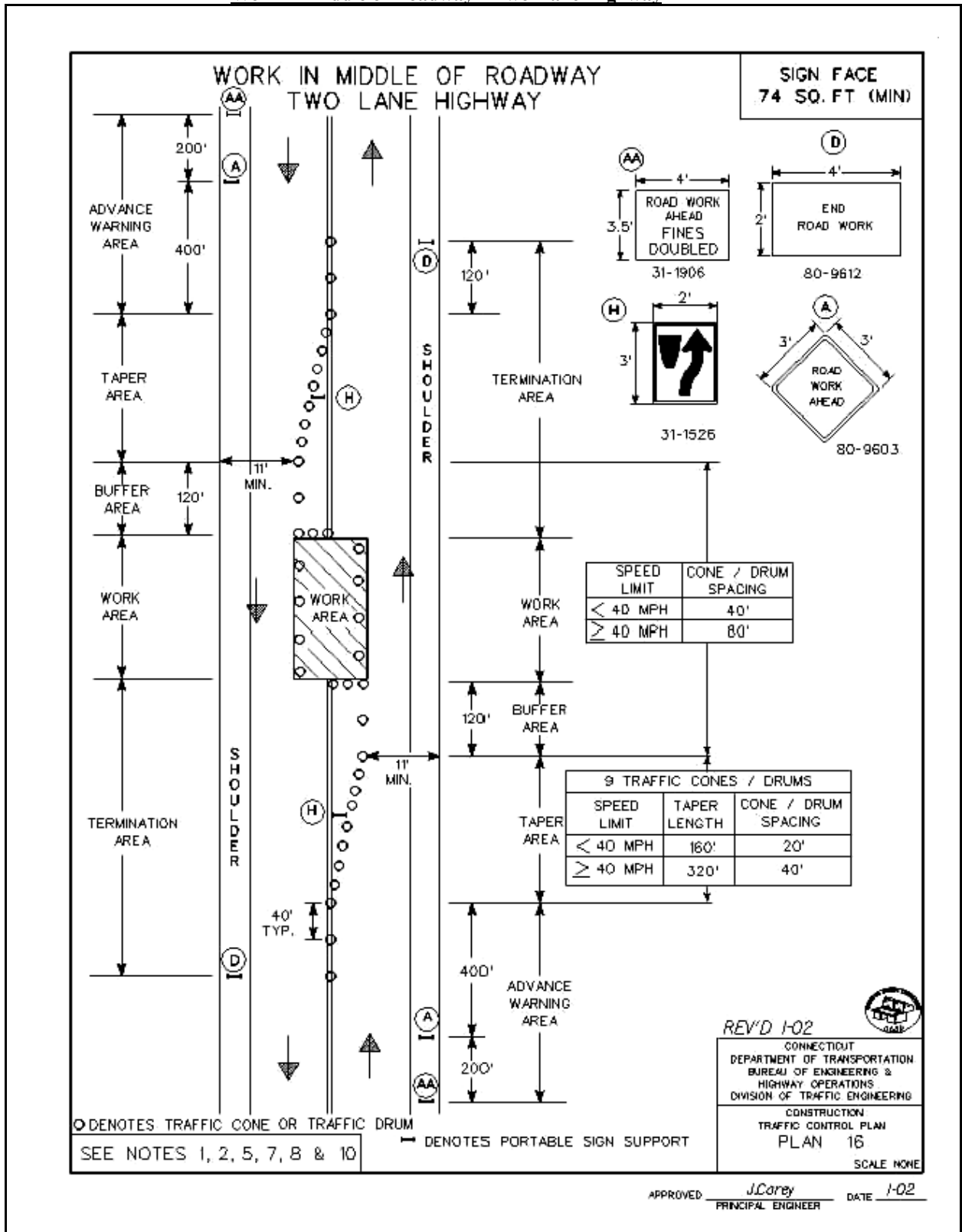

Figure 2-9.28 Traffic Control Plan 17
Work in Middle of Roadway at Intersection

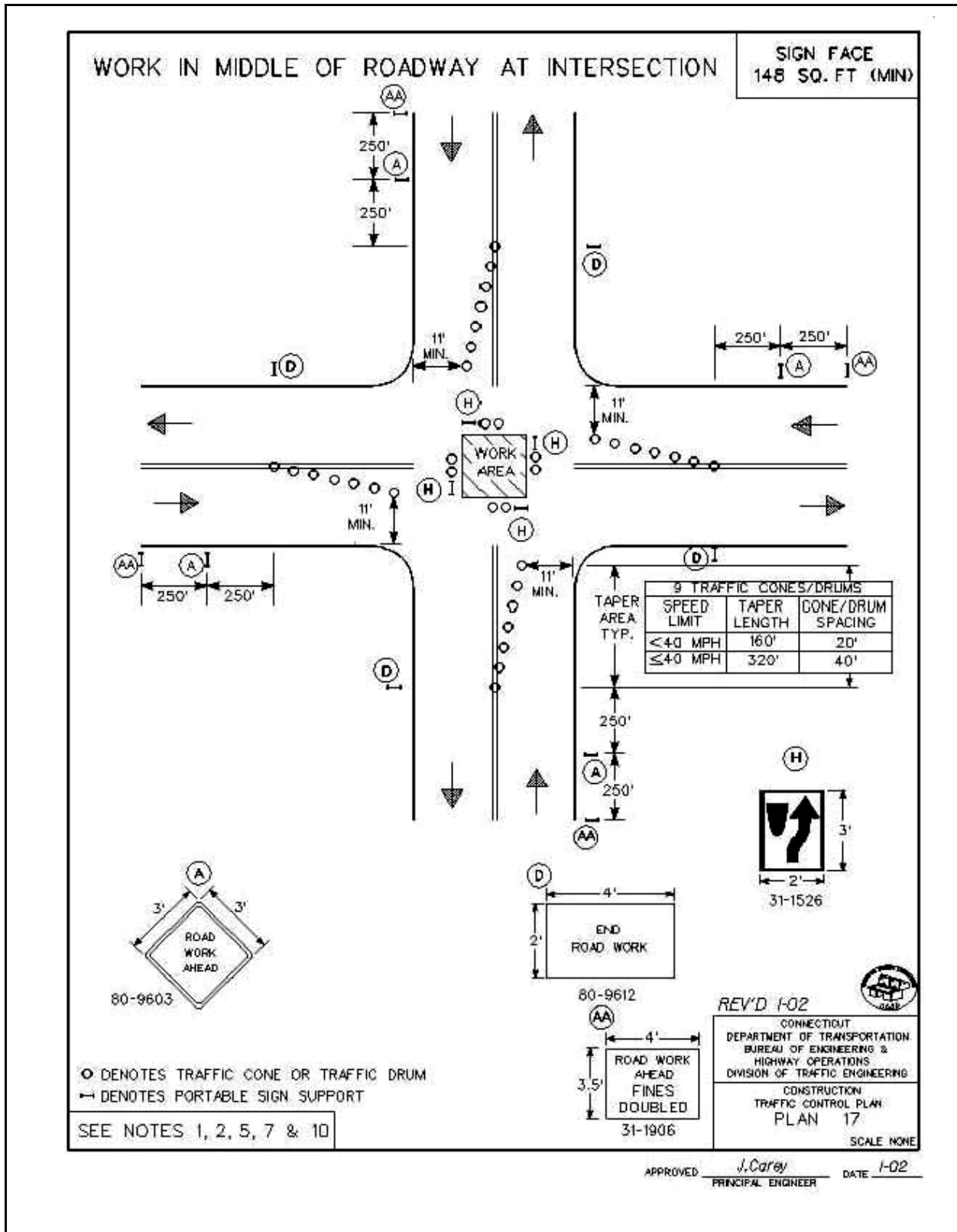

Figure 2-9.29 Traffic Control Plan 18
Work in Travel Lane and Shoulder—Two-Lane Highway
Alternating One-Way Traffic Operation—Stop Sign Control

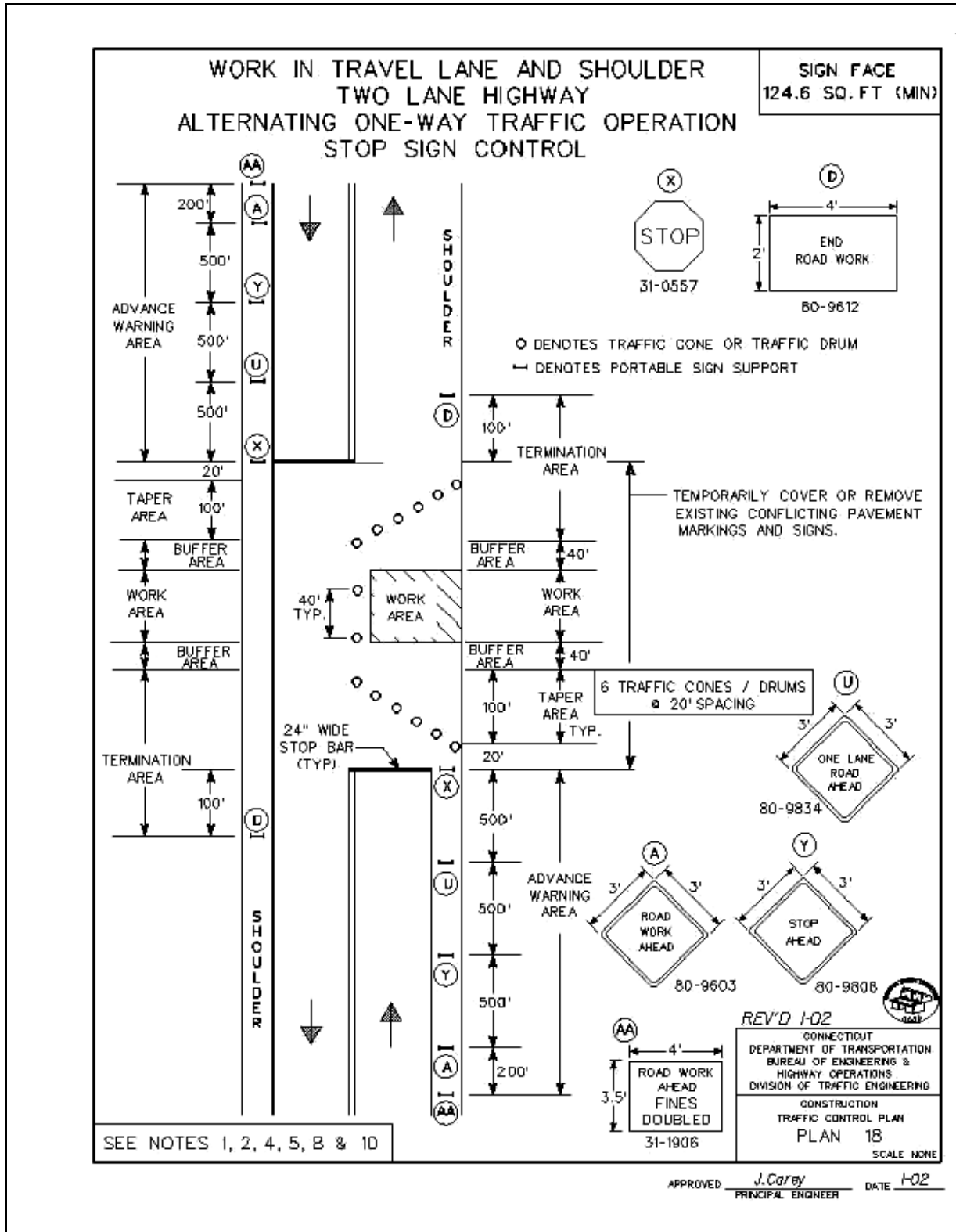

Figure 2-9.30 Traffic Control Plan 19
Moving Operation on Right Shoulder—Multilane Highway and Secondary Roadways

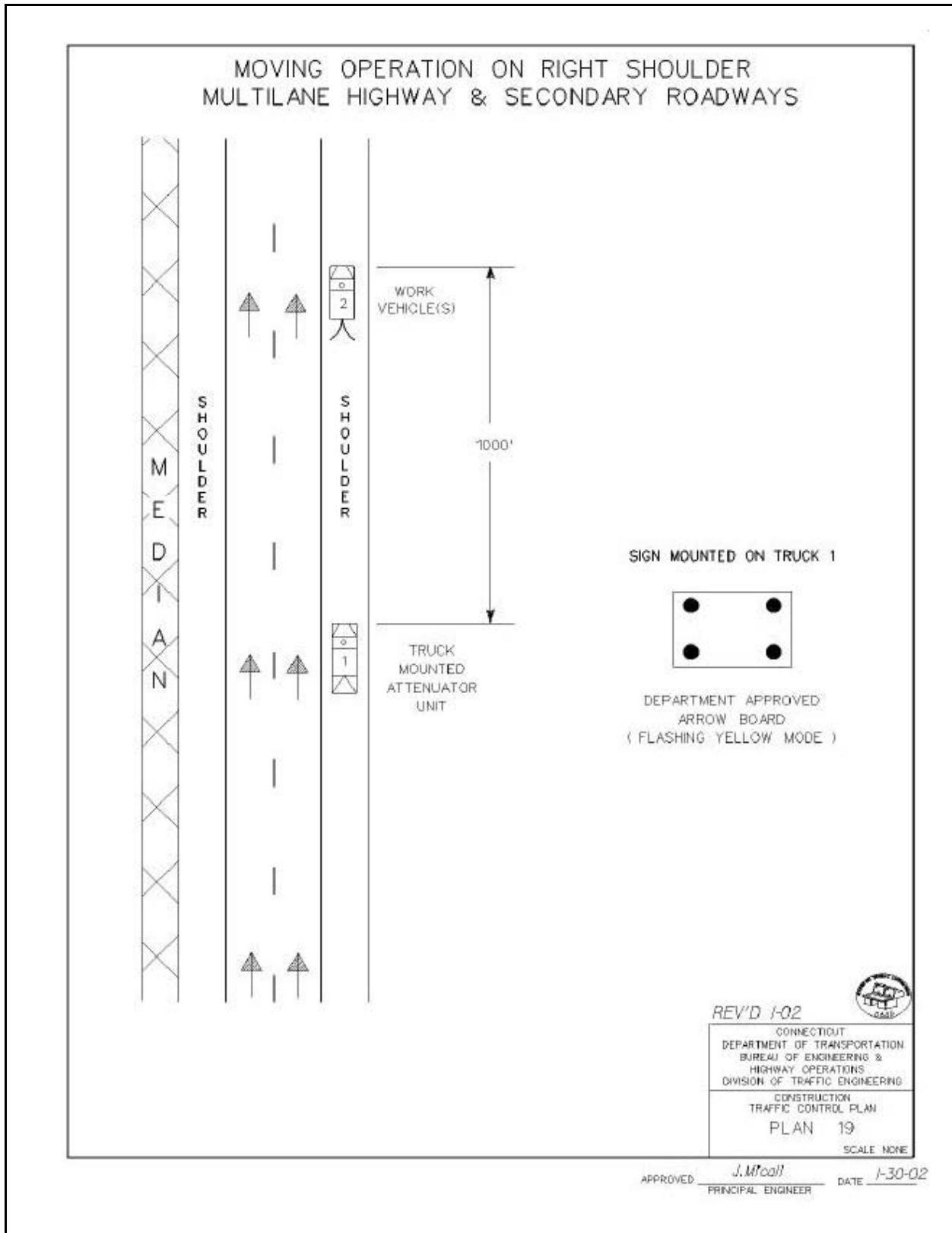

Figure 2-9.31 Traffic Control Plan 20
Moving Operation in Right Lane and Outside Shoulder at the Same Time—Multilane Highway

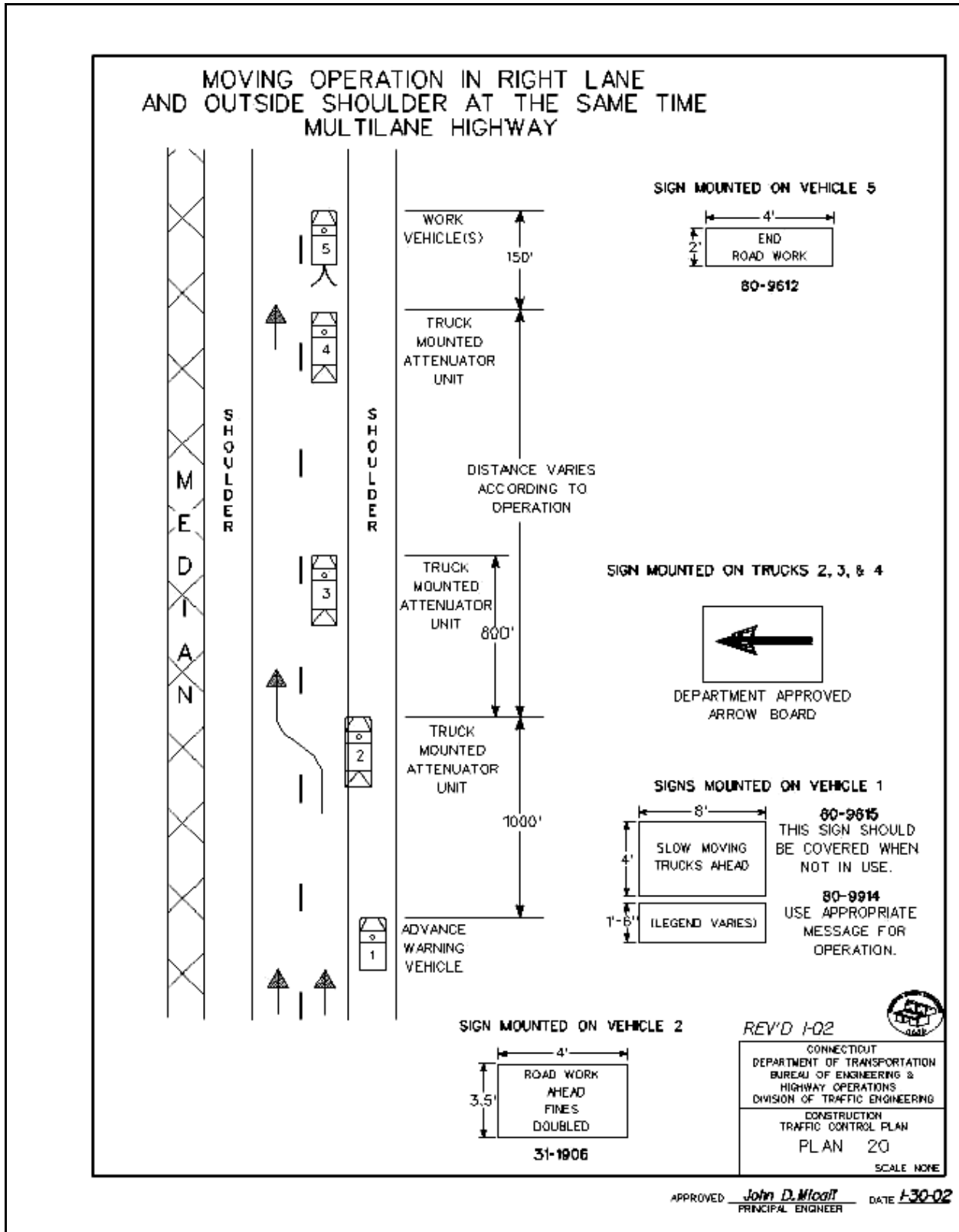

Figure 2-9.32 Traffic Control Plan 21
Moving Operation in Left Lane and Inside Shoulder at the Same Time—Multilane Highway

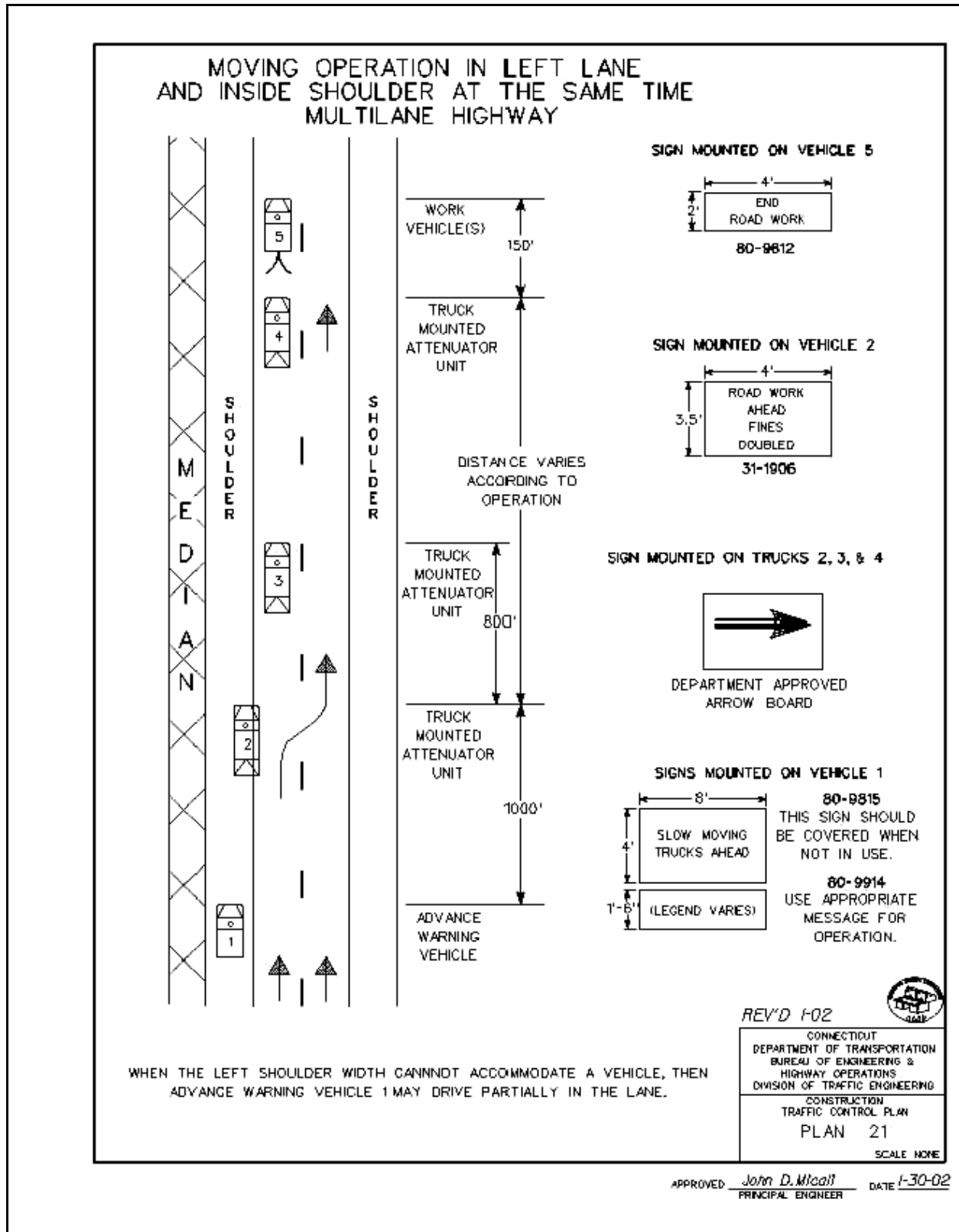
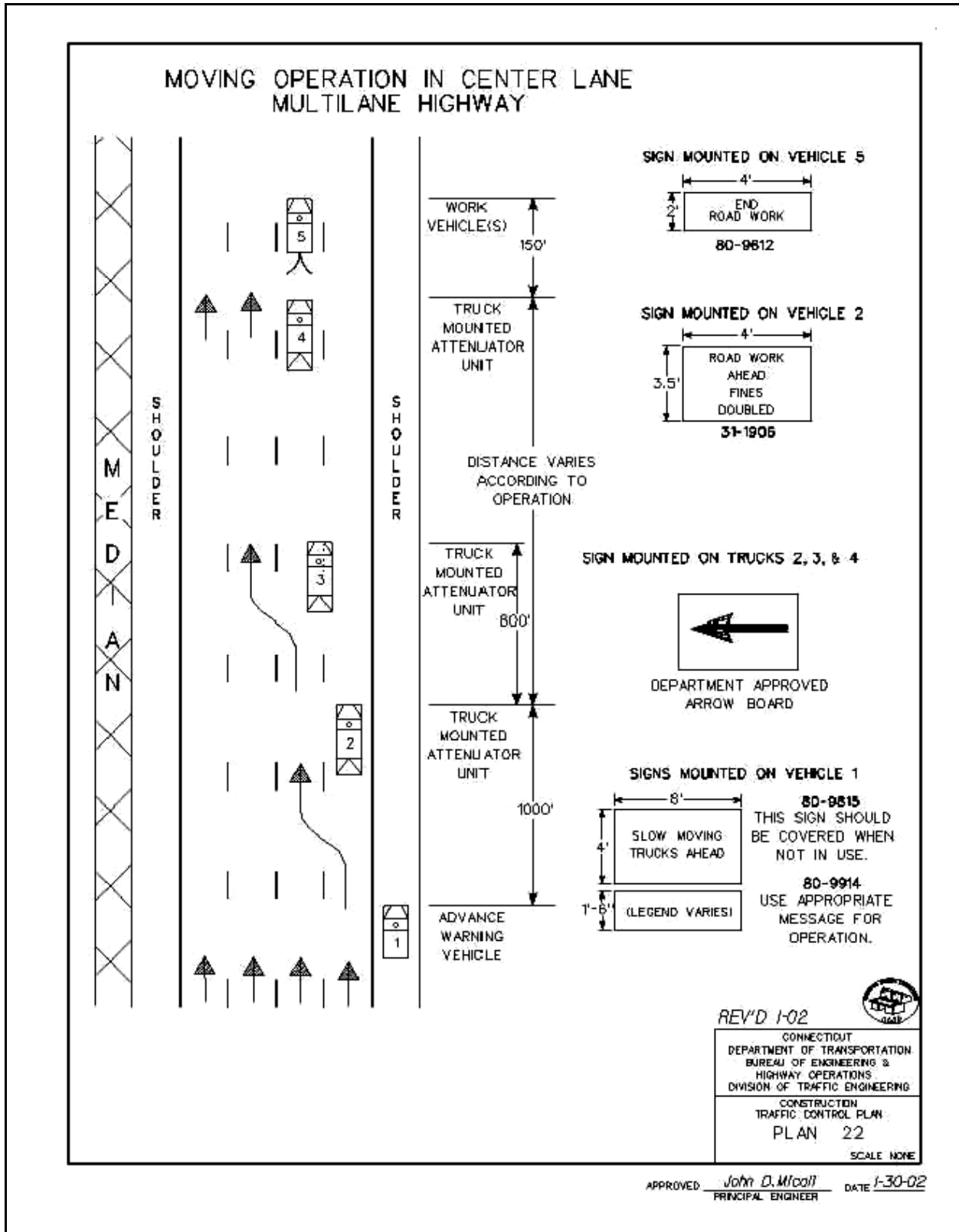

Figure 2-9.33 Traffic Control Plan 22
Moving Operation in Center Lane—Multilane Highway



Figures 2-9.34 Traffic Control Plan 23
Moving Operation in Center Lane—Multilane Highway

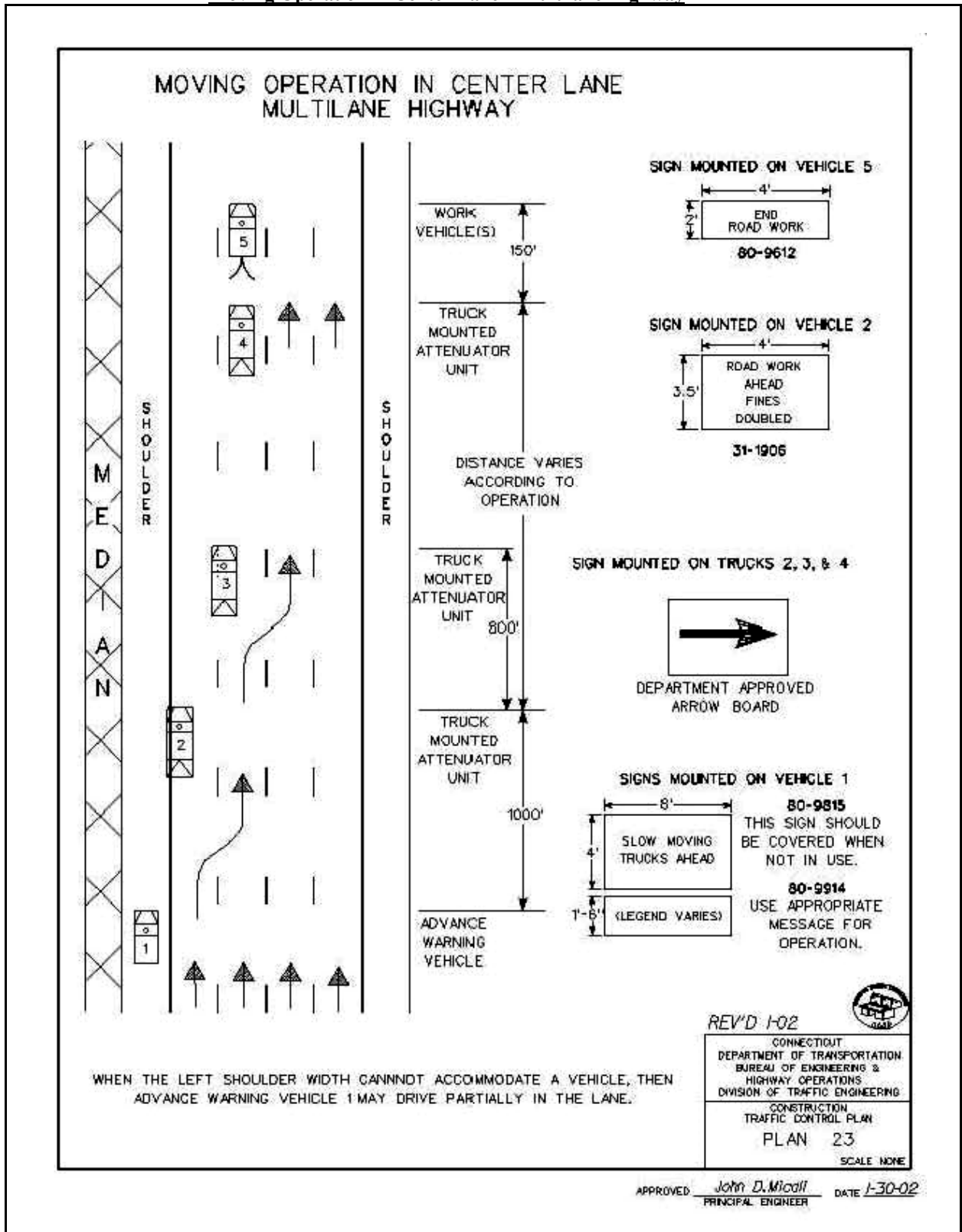

Figure 2-9.35 Traffic Control Plan 24
Moving Operation—Two-Lane Highway

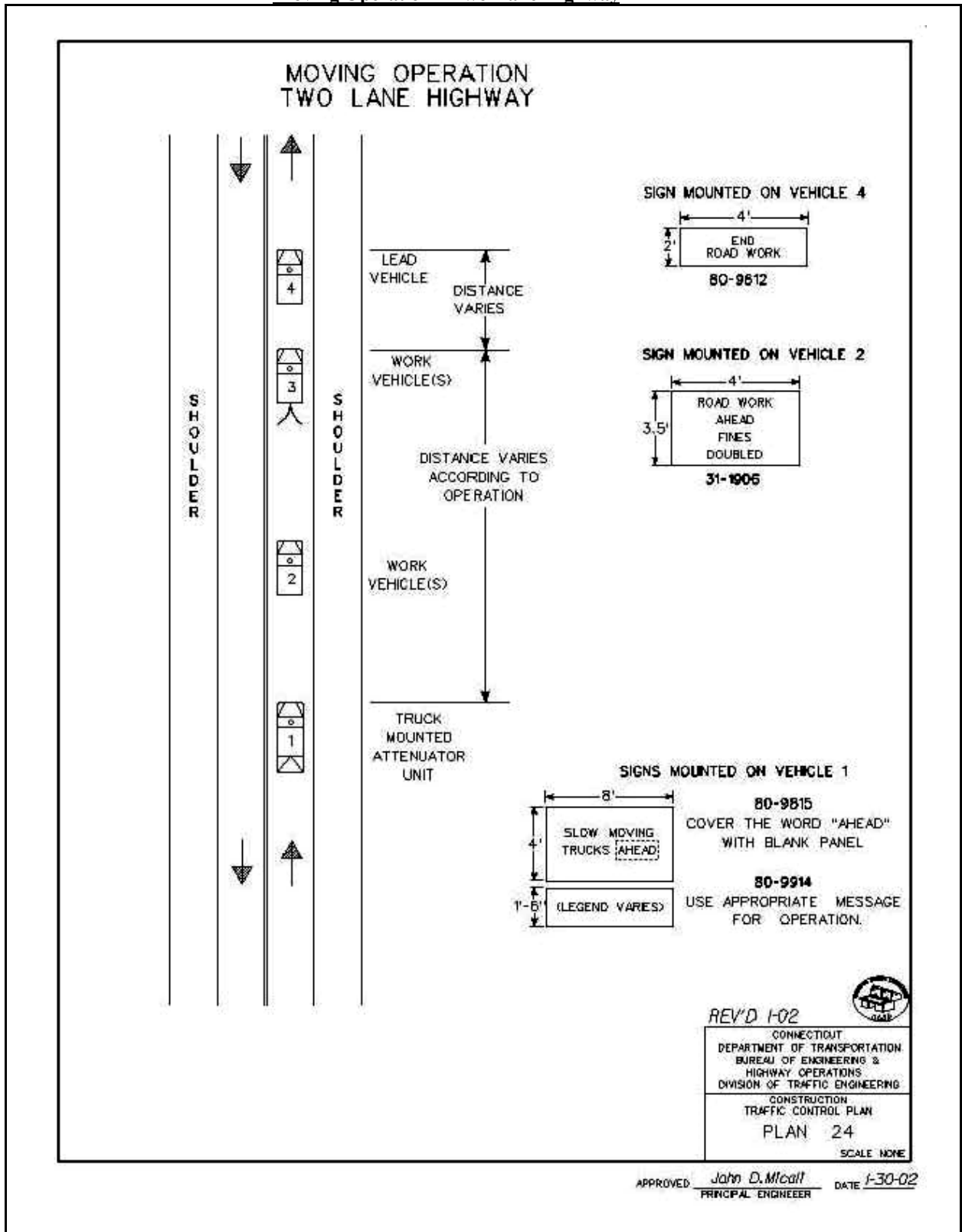

Figure 2-9.36 Traffic Control Plan 25
Mowing Operation—Multilane Highway

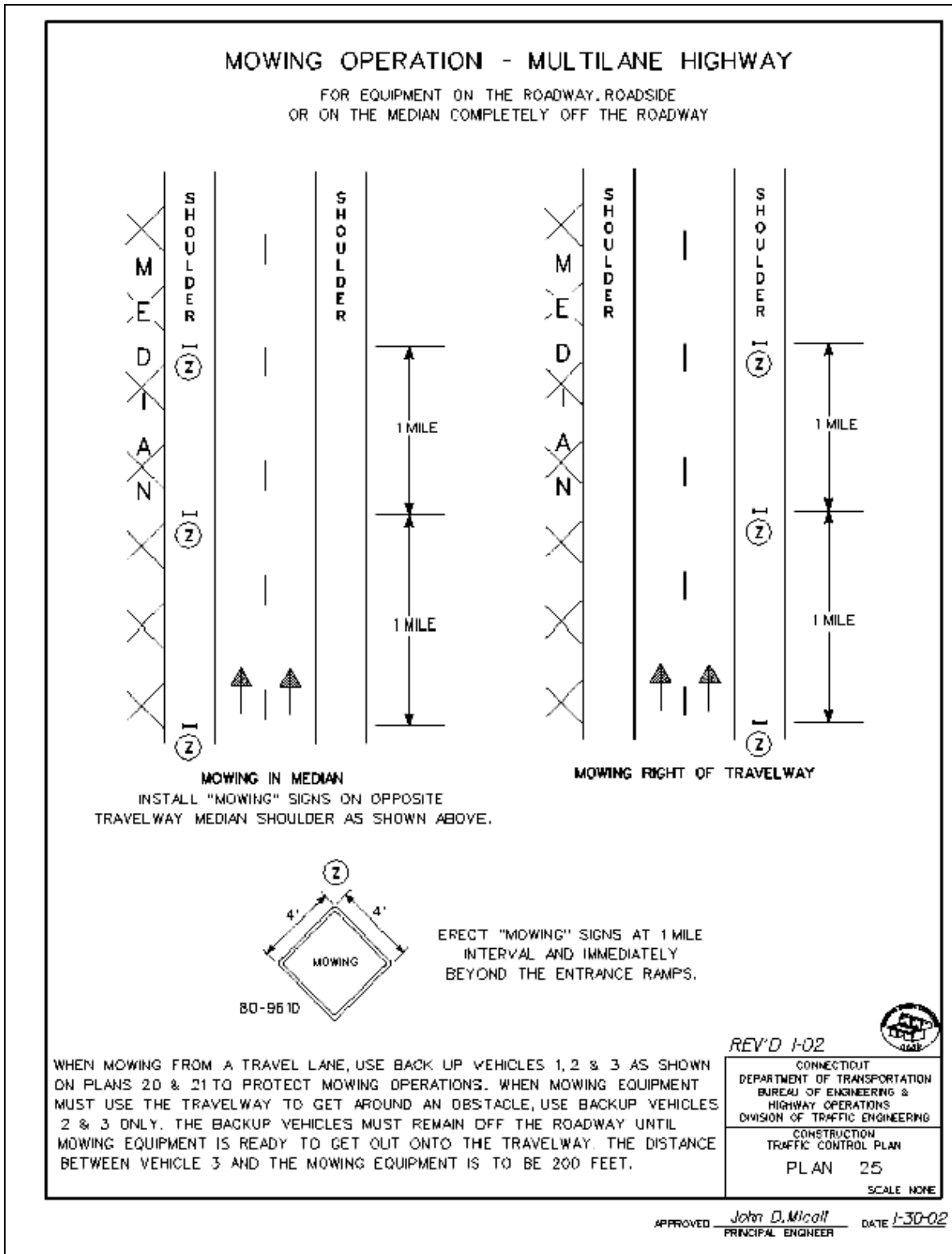

Figure 2-9.37 Traffic Control Plan—H.O.V. Plan 1
Work in Restricted Lane (Stationary Closure)

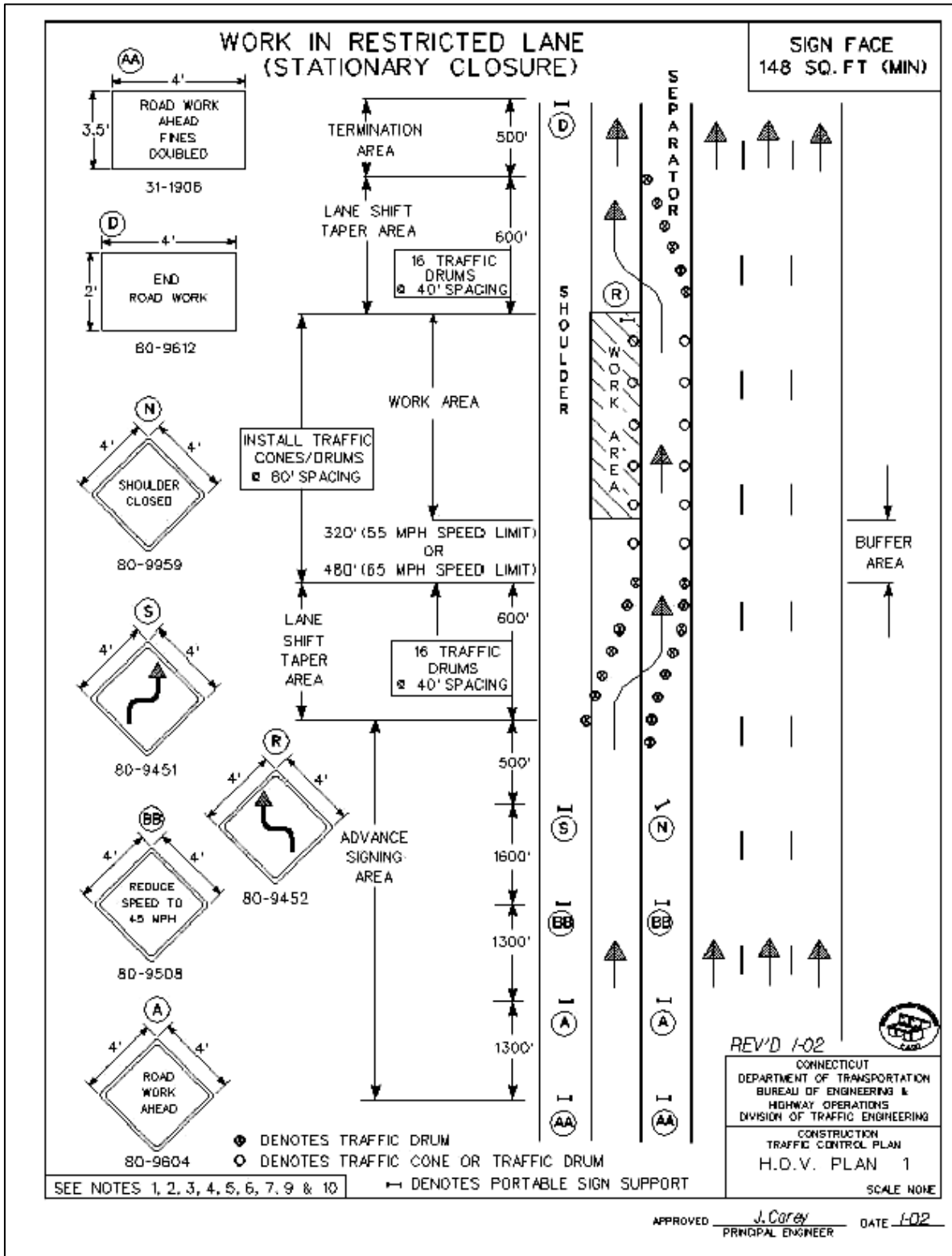
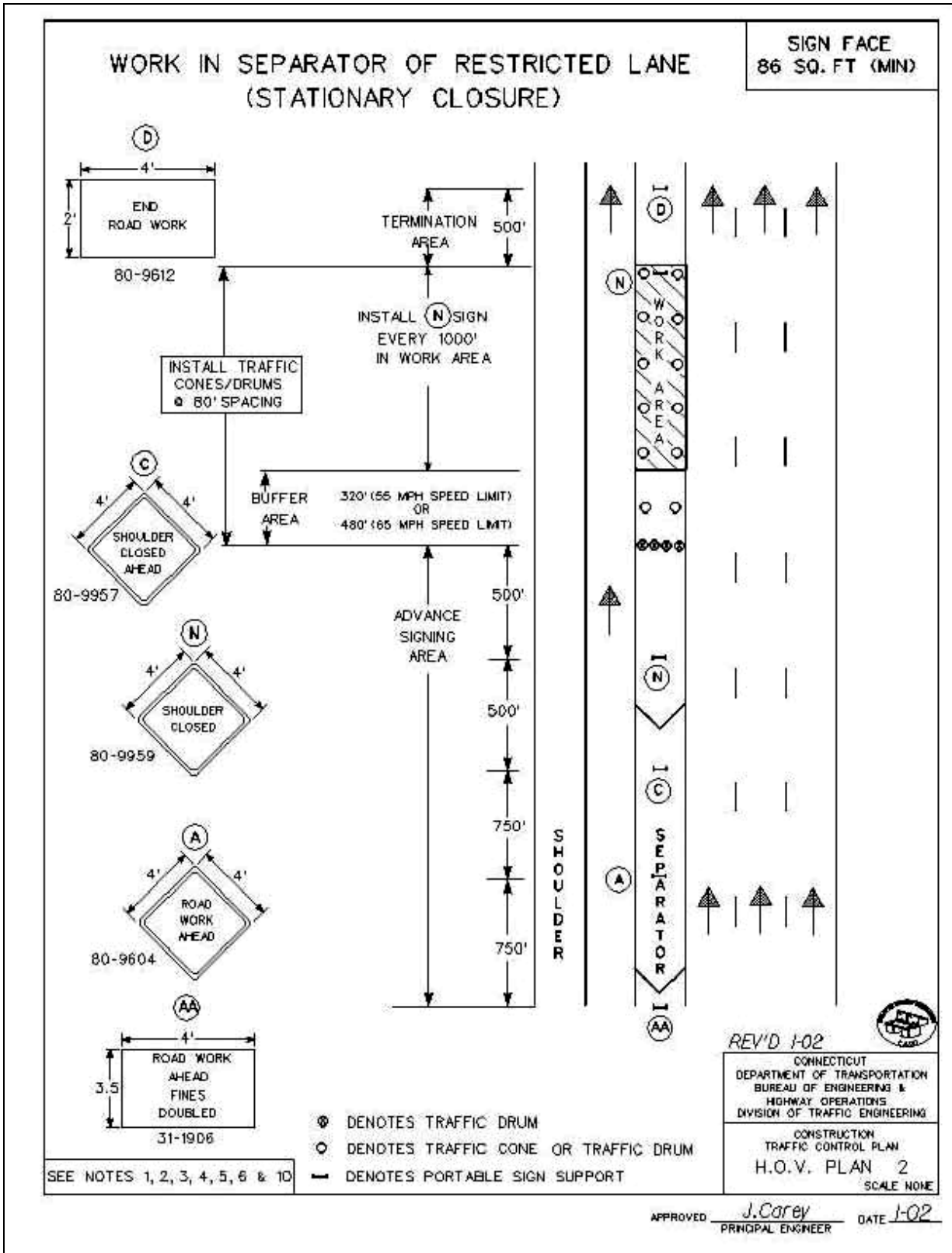
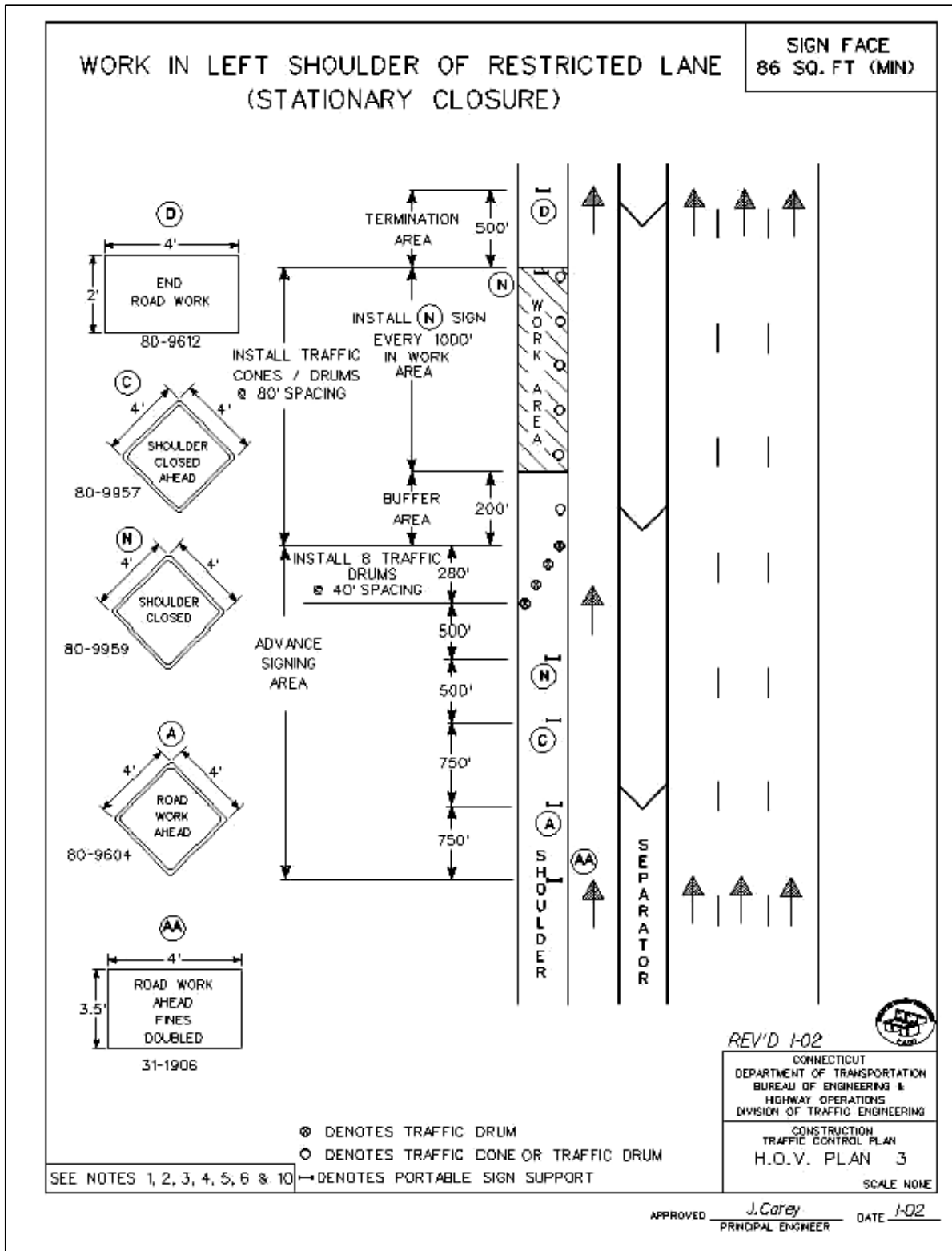

Figure 2-9.38 Traffic Control Plan—H.O.V. Plan 2
Work in Separator of Restricted Lane (Stationary Closure)



**Figure 2-9.39 Traffic Control Plan—H.O.V. Plan 3
Work in Left Shoulder of Restricted Lane (Stationary Closure)**



**Figure 2-9.40 Traffic Control Plan—H.O.V. Plan 4
Moving Operation in Restricted Lane**

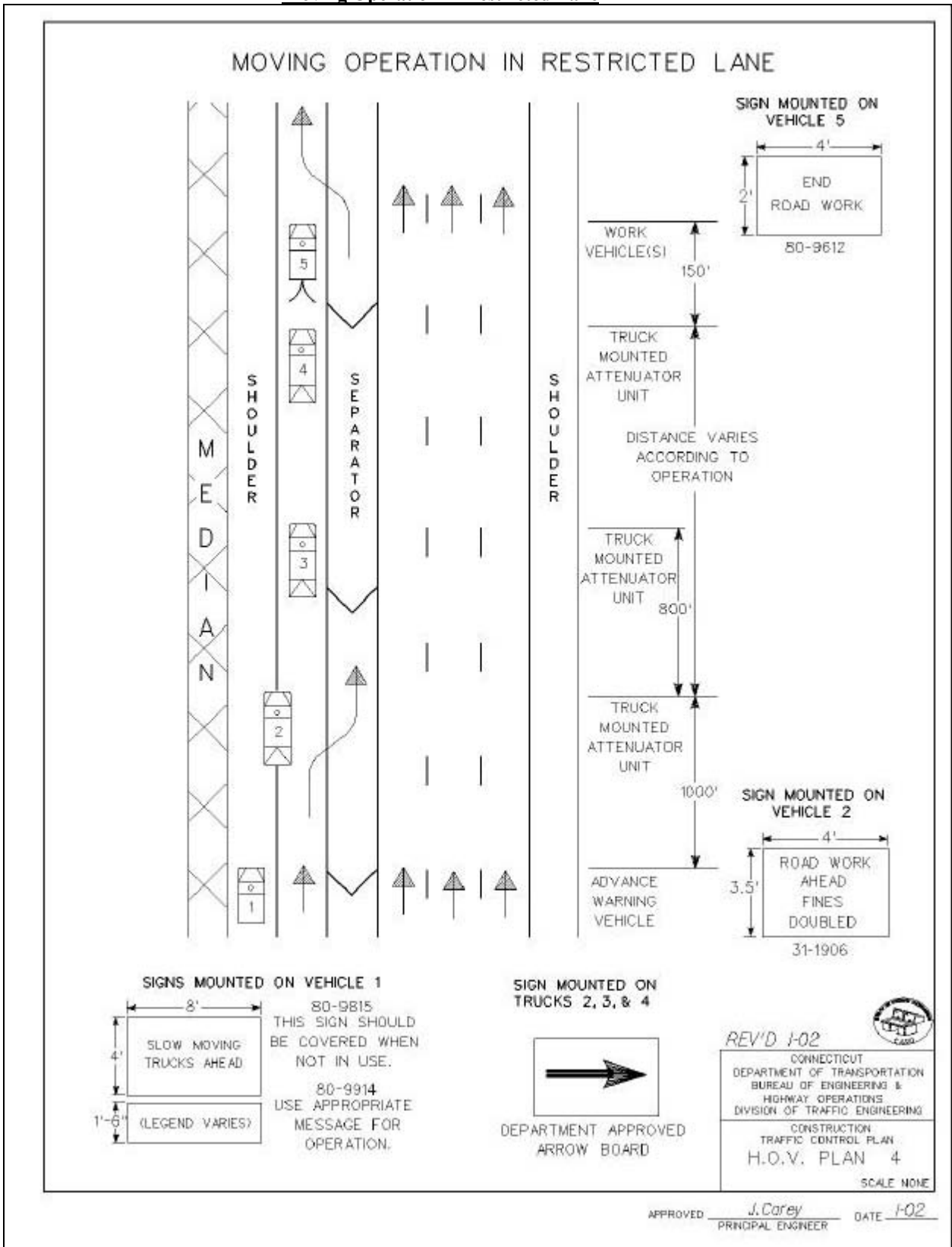

Chapter 10 - Miscellaneous Construction

2-1001 Riprap

Riprap consists of angular stones used to protect foundations of piers, abutments, walls, slopes of embankments, and waterways from damage. Riprap is covered in Article 7.03 of the *Standard Specifications*.

The area to be protected by riprap is shaped. If bedding material is called for in the plans, the bedding material is placed and compacted to the plan line and grade. Riprap is placed to its full-course thickness in one operation. Placement should not displace the underlying material. The finished surface should be free of small stones and clusters of large stones. Rearranging the stones may be required to produce a reasonably well-graded distribution of the specified stone sizes.

2-1002 Gabions

Gabions consist of wire baskets filled with aggregate. They are covered in Article 7.04 of the *Standard Specifications*.

The wire baskets can be made of either galvanized steel or galvanized steel coated with polyvinyl chloride (PVC). The contractor must furnish a certified test report or materials certificate and certificate of compliance. The maximum dimension of the mesh opening must not exceed 4.5 in. (115 mm), and the area of the mesh opening must not exceed 8 sq. in. (9500 mm²).

The baskets must be fabricated so that they can be assembled at the site. The front, back, base and lid must be woven at the factory in a single unit. All perimeter edges of the mesh must be securely salvaged. Lacing wire must be supplied in quantities sufficient to fasten all of the edges of the baskets and diaphragms and to provide for the internal connecting wires in each cell.

Each side of the aggregate for filling the baskets must be between 4 in. (100 mm) and 13 in. (330 mm) or 0.7 of the basket's smallest dimension, whichever is less. It should be reasonably well graded between the limiting sizes.

The baskets are assembled by binding together all vertical edges with lacing wire on 5 in. (125 mm) spacing, as shown in Figure 2-10.1, or by looping a single wire around the vertical edges, with a coil every 5 in. (125 mm). The empty baskets are set to line and grade. Adjacent baskets are laced together along the perimeter of their contact surfaces as shown in Figure 2-10.2. The empty baskets that form the upper tier of the construction are laced to the tops of the ones beneath them. A fence stretcher or other approved device must be used to remove any kinks and to hold the proper alignment of the units.

The aggregate must be placed carefully to assure alignment, avoid bulges, and produce a minimum of voids.

The aggregate is placed up to the level of the first connecting wires. The sets of connecting wires are placed perpendicular to each other and tied around two meshes of each gabion wall. Figure 2-10.3 shows typical positions of the connecting wires. Then the aggregate is placed up to the level of the next connecting wires or to the top of the basket. The lid of the basket is stretched tightly over the aggregate until it meets the edges of the front and end panels. The lid is laced tightly along the edges, sides and diaphragms.

Figure 2-10.1 Gabion Field Assembly

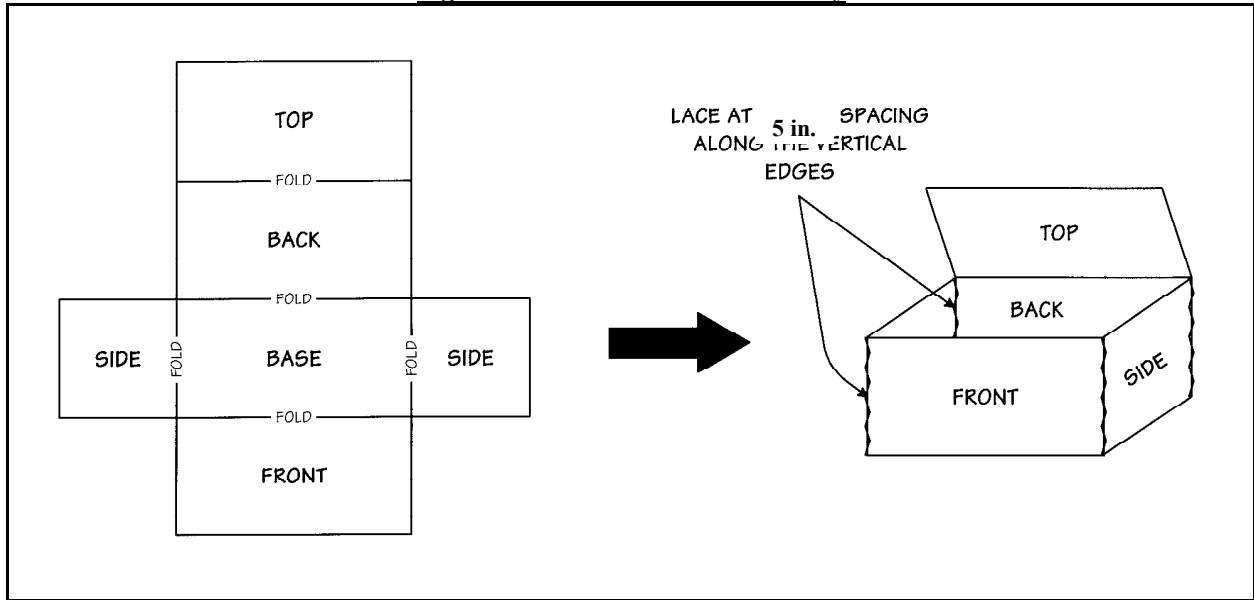

Figure 2-10.2 Gabion Placement

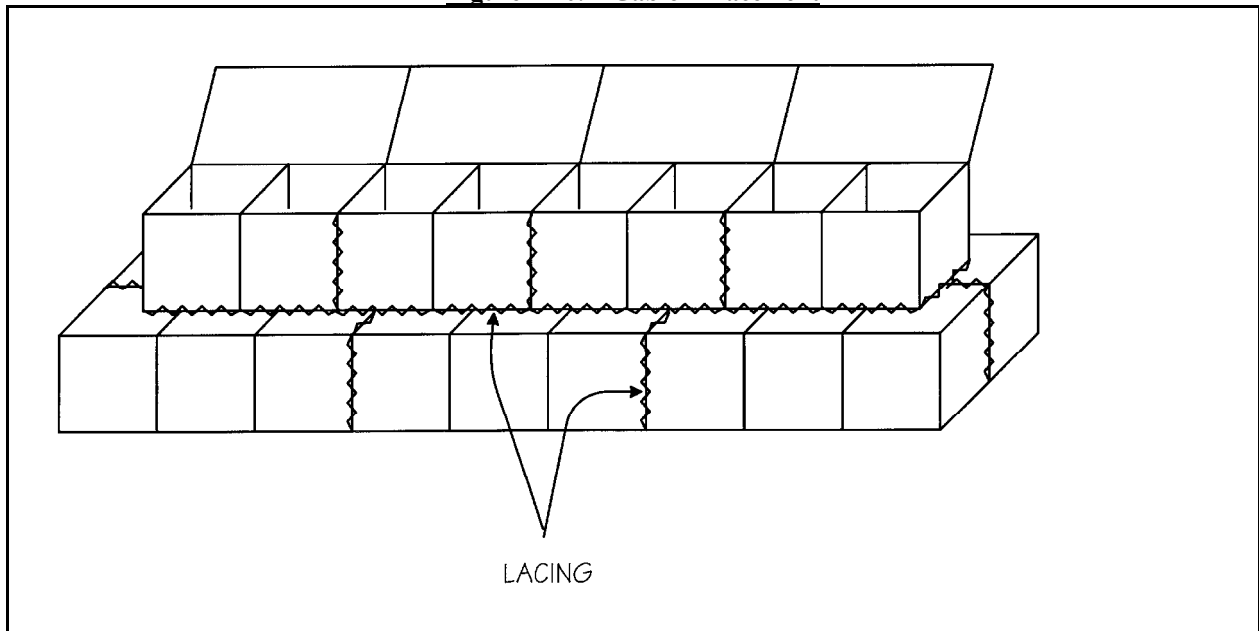
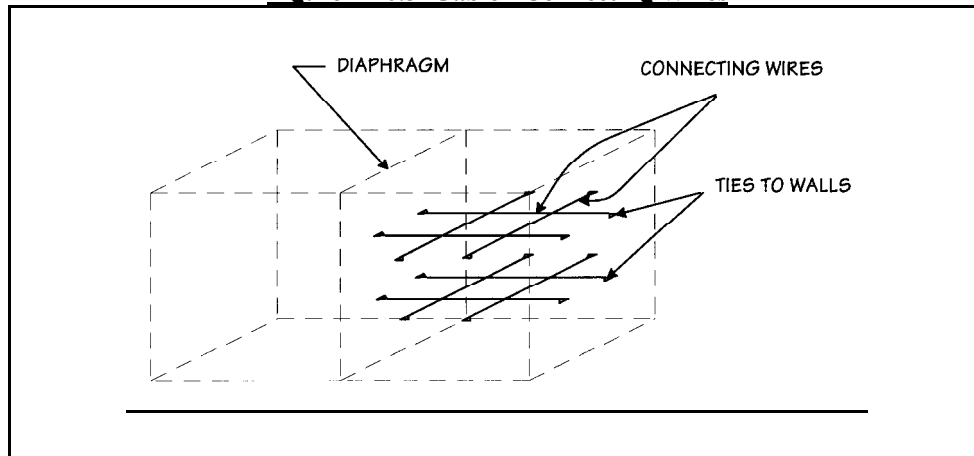

Figure 2-10.3 Gabion Connecting Wires



2-1003 Wire Fence

Wire fence consists of galvanized, chain link, or aluminum fence fabric supported by wood or metal posts. It is covered in Article 9.06 of the *Standard Specifications*. Fencing materials are covered in Article M.10.04.

2-1003A Wood Posts

For wire fence with wood line posts set in earth, the posts are set 10 ft. (3 m) apart and 3 ft. (1 m) in the ground and to the lines and grades given. For line posts set in rock, metal posts must be used.

The wire fabric normally is placed on the side facing the highway. The bottom of the fabric is placed 6 in. (150 mm) above the ground or as ordered by the Engineer. The fence is attached to the posts with galvanized staples 1½ in. (38 mm) long. A sufficient number of braces must be added to the posts to hold them firmly when the wire is stretched. Untreated posts are cut off 3 in. (75 mm) above the top wire on a bevel or as directed by the Engineer.

2-1003B Metal Posts

Line post spacing is the same as for the wood line posts above. Care must be taken to ensure the metal posts are plumb and the anchor plate is down. The posts should not be damaged when they are driven. When driving the posts, the tops must be protected by driving caps, or a suitable maul may be used.

When exposed ledge rock is encountered, the anchor plate is omitted from the metal post, and a hole is drilled into the rock at least 12 in. (300 mm) deep. The post is set in the hole using grout.

The Engineer directs on which side of the posts the wire fencing is placed. The fabric usually is placed 6 in. (150 mm) above the ground. It is attached to the posts using standard approved means, such as aluminum bands, zinc-coated steel bands, or spring-wire clips. Braced pull posts are installed as needed.

2-1003C End, Corner and Pull Posts

All end, corner and pull posts are set in concrete footings. The footings are constructed of Class A concrete, which may be hand mixed. The footings are a minimum of 3 ft. (1 m) deep and not less than 8 in.

× 8 in. (200 mm × 200 mm) at the top and 10 in. × 10 in. (250 mm × 250 mm) at the bottom. Figure 2-10.4 shows a pull post.

Braces are attached about 18 in. (450 mm) from the top of the post. They must be long enough to be set in the ground and form an angle of not less than 45 degrees with the post. The braces can be set in concrete bases or attached to metal brace plates. The concrete base must be not less than 1 cu. ft. (0.03 m³). The brace plate must have a face area of not less than 1 sq. ft. (0.1 m²) and a thickness not less than 3/16 in. (5 mm).

Figure 2-10.-4 Wire Fence Pull Post

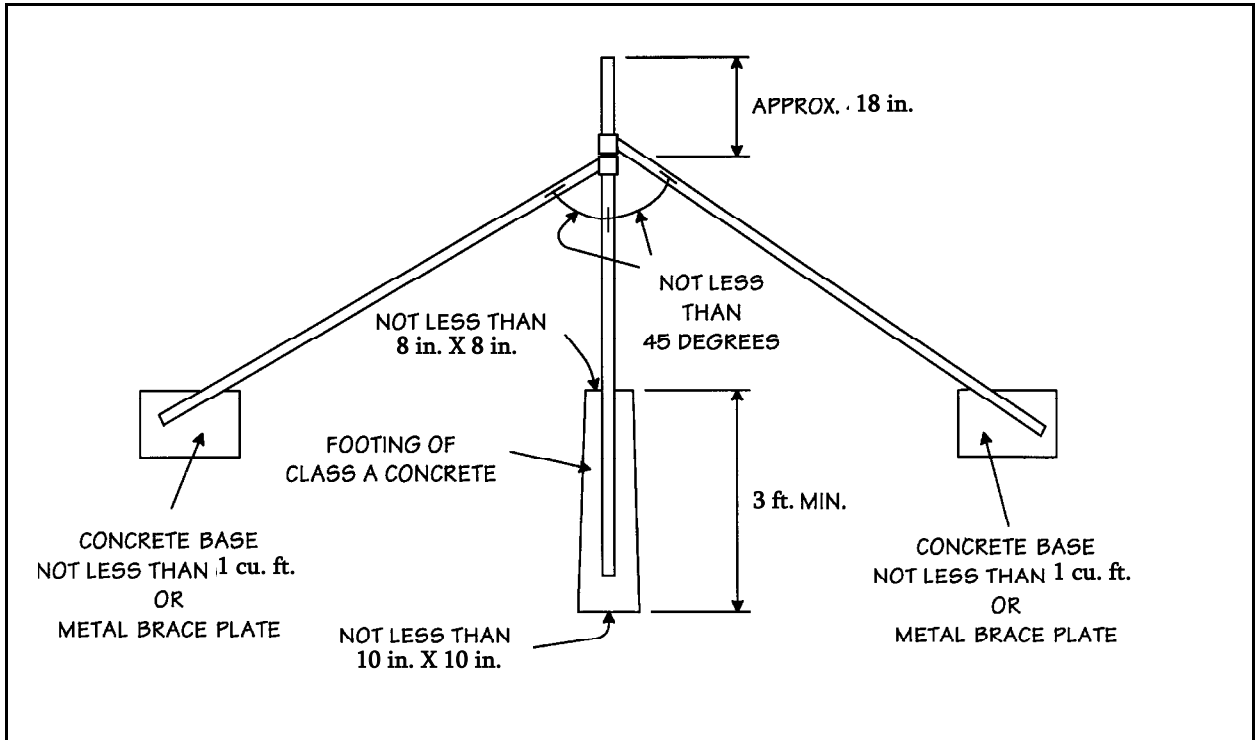

2-1004 Metal Beam Rail

Metal beam rail consists of a single or double line of rail elements fastened to galvanized steel posts, with or without rub rail. End treatments are as shown on the plans. The rail is erected at the locations and fabricated in accordance with the locations, designation, dimensions and details shown on the plans or ordered by the Engineer. Metal beam rail is covered in Section 9.10 of the *Standard Specifications*. Section 9.11 covers metal beam rail anchorages. Other contract language may cover the Repair of Guiderail.

2-1004A Material Inspection

The posts, rail, rub rail, hardware, anchorage elements, etc., must be sampled at the project site in accordance with the “Schedule of Minimum Requirements for Sampling Materials for Test,” published by the Materials Testing Division.

Before erecting the rail or anchorages, the Inspector should check galvanized elements. Any that have been cut or worked so as to destroy the galvanized coating and expose the base metal must be cleaned and painted with one coat of zinc dust-zinc oxide paint and a finish coat of aluminum paint.

2-1004B Posts

Posts are located in accordance with the plans, set plumb and in alignment with the rail or rail treatments. The contractor must provide extra-length posts at transitions or where field conditions warrant. The long posts must be long enough to maintain the minimum depth under the ground, as shown on the plans.

The steel posts are driven, except for the end-anchor posts. If rock or boulders are encountered, they are removed and the hole is backfilled and compacted before driving the posts. The contractor must provide suitable driving caps and equipment to prevent battering or injury to the posts and to prevent injuring the galvanized coating of the posts above ground line. End-anchor posts are set in dug holes. After the posts are set, the holes are backfilled and compacted. Surplus material must be removed.

The contractor should be cautious of buried cable for illumination or utilities located within the right-of-way. The cables may be "live." Care should also be taken when the rail system crosses over box culverts, culverts, or other roadway substructures as the posts should not puncture any structure.

2-1004C Rail

If required, the brackets, rub rails, backup rails and rail elements must be erected to produce a smooth, continuous rail. If possible, the terminal sections, rub rails, and rail elements should be lapped in the direction of traffic.

If the rail installation is along a road with traffic, the contractor should complete the installation, including the end treatment, at the end of each day's work to avoid creating a hazard caused by leaving an exposed end of the beam or rub rail. If this is not practicable, the contractor must provide a temporary end treatment by lowering the rail to the ground and anchoring it by bolting, weighting, burying, etc. The contractor must submit to the Engineer a detailed plan for the temporary end treatment. No work is allowed until the plan is approved.

When a section of guiderail including end anchors is complete and functional, and testing requirements have been met, a notation of the beginning station (or mile marker) and ending station (or mile marker) should be entered on the DWR. In addition, a letter is to be sent to the Contractor noting the date and location of the completed section. This documentation may be used for backup if payment becomes required under a contract item for the Repair Guiderail. Some contracts may have this item if it is anticipated a section of rail could be damaged by public traffic before the Project is completed. See 2-1004F.

2-1004D Welding

In welding steel plates to steel posts, the welds will be the same size and shape as shown on the plans and must conform to the requirements of the current *Specifications for Welded Highway and Railway Bridges* of the American Welding Society, with two exceptions:

- Only a visual inspection of the welds is required.
- The Engineer will make the visual inspection. All welds must have no visual cracks or be defective in any way. All must be formed in a neat and workmanlike manner. Any welds found unacceptable will be corrected by the contractor at no additional cost.

2-1004E Anchorages

The work involves the installation of concrete end anchors, fittings, rail elements, terminal sections, and posts. An example anchorage is shown in Figure 2-10.5. The excavation for the anchorage is backfilled with suitable material and compacted in 6 in. (150 mm) layers. Surplus material must be removed by the contractor.

If the rail is to be attached to rock, the rock is shaped as needed, and holes are drilled in the rock. The diameter of the holes is great enough to permit placing the bolts but must not exceed twice the diameter of the bolts. The bolts are installed in the holes, and the holes are filled with non-shrink grout. After the steel plate is installed, it and any spalled areas are filled with non-shrink grout. The same method is used for rail attached to concrete.

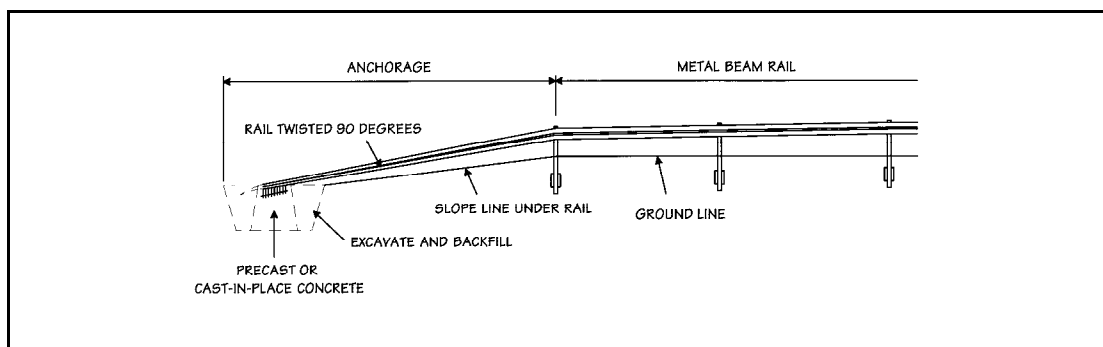
Figure 2-10.5 Metal Beam Guiderail Anchorage**2-1004F Repair Guiderail**

This item may be included as an Estimated Item in the original Contract or can be added by Construction Order with the pay unit "Cost Plus." The criteria for the use of this item will be outlined in the applicable contract specification language.

2-1005 Turf Establishment

The work consists of providing a uniform stand of established perennial turf grasses. It includes furnishing and placing fertilizer, seed and mulch as shown on the plans or ordered by the Engineer. Turf establishment is covered in Article 9.50 of the *Standard Specifications*. Materials for turf establishment are covered in Article M.13.

2-1005A Seedbed Preparation

Level areas, medians, interchanges and lawns are made friable and receptive to seeding by disking, tracking, or other methods approved by the Engineer. The final prepared and seeded soil must meet the lines and grades on the plans. Slopes and embankment areas are prepared by approved methods that do not disturb the line and grade of the slope surface. Seeding is never permitted on hard or crusted soil surfaces.

All areas to be seeded must be relatively free from weeds taller than 3 in. (75 mm). The weed growth can be mowed by hand or reduced with other approved methods that do not disturb the slope line or grade. Seeding on level areas is not permitted until essentially all of the weed growth is removed.

Slopes are to be seeded within 7 days after reaching final grade. Areas to be left more than 30 days without being worked are to be seeded or mulched as per Article 1.10.03-11 of the *Standard Specifications*.

2-1005B Seeding and Fertilizing

The calendar dates for seeding are:

- March 15 to June 15 for spring seeding and
- August 15 to October 15 for fall seeding.

Areas at final grade can be seeded within season. Other disturbed areas receive out-of-season seeding, although the contractor is still responsible for establishing the turf as described in “Establishment and Cleanup” below. During out-of-season periods, unseeded disturbed areas must receive water pollution control treatments, as in Article 2.10 of the *Specifications*. The treatments must be removed prior to seeding unless the Engineer allows them to remain.

Fertilizer initially is applied at 320 lb./A (360 kg/ha). When the permanent grass seeding growth reaches 6 in. (150 mm), the grass is mowed to 3 in. (75 mm), and another 320 lb./A (360 kg/ha) is applied. The second application must be hydraulically placed.

2-1005C Establishment and Cleanup

The contractor must maintain a uniform, established stand of the turf grass species. The height must be 6 in. (150 mm), and the stand must consist of no less than 100 plants/sq. ft. (1100 plants/m²). The contractor must maintain the established turf until the entire project is accepted.

The contractor must keep all equipment, vehicles and pedestrians off seeded areas to prevent excessive compaction and damage to young plants. If an area is compacted excessively, the contractor must rework the soil to form a seedbed, then reseed and mulch the area.

The contractor must keep all seeded areas free of weeds and debris. When the permanent grass growth reaches 6 in. (150 mm), the contractor must mow all slopes 4:1 or flatter to a height of 3 in. (75 mm). The mowing is done on a one-time-only basis. The contractor must clean up all debris from the turf establishment operation on the shoulders, pavement, and adjacent private or public property.

2-1006 Erosion Control Matting

Erosion control matting is installed following seeding, where called for on the plans or directed by the Engineer. Staples are placed according to the manufacturer's recommendations. Where two lengths of netting overlap, the end of the up-grade strip should overlap the down-grade strip. The contractor must maintain and protect the erosion control matting until the turf is established and must repair any damaged areas. No mowing is required where erosion control matting is installed.

2-1007 Sodding

Sodding consists of preparing a sodbed of 4 in. (100 mm) of tamped topsoil and furnishing and placing live sod. The work is covered under Article 9.53 of the *Standard Specifications*.

The work can be done at any time of year, but the sod cannot be frozen or placed on frozen earth. The contractor must notify the Engineer 48 hours before starting to work and cannot proceed until the Engineer grants permission. If seeding and sodding are to be done in the same general area, the sodding must be done prior to the seeding.

The contractor must take care to retain native soil on the roots of the sod during the process of transplanting it. Dumping the sod from trucks is not permitted. The sod should be placed within 24 hours after harvesting it unless it is tightly rolled roots to roots, kept moist, and protected from the sun and from freezing.

2-1007A Ground Preparation

There must be not less than 4 in. (100 mm) of tamped topsoil under the sod unless otherwise specified. Excavations or trenches must be made below the finished grade deep enough to accommodate the topsoil and sod.

If fertilizer was not applied to the topsoil during another operation, it is spread to provide 100 pounds of nitrogen per acre (110 kilograms of nitrogen per hectare). It must be incorporated in the topsoil to a depth of at least 2 in. (50 mm). It can be incorporated by disking, harrowing, drilling, raking, etc. Lime is not required but is permitted if applied in a previous operation.

2-1007B Planting

The soil on which the sod is laid must be reasonably moist and must be watered if needed. The sod is laid smoothly edge to edge. Any open areas are plugged with sod.

In drainage ways and areas requiring continuous or solid sodding, the sod is laid with its longest dimension parallel to the contours of the ground. The sod is placed first at the base of a slope, and work progresses up the slope parallel to the contour lines. Vertical joints are staggered from one course to the next.

After the sod is laid, it is immediately pressed into the sodbed by tamping, rolling, etc. to eliminate air pockets, provide smooth surfaces, ensure knitting, and protect exposed sod edges. It is watered at 5 gal./sq. yd. (20 L/m²).

2-1007C Pegging

Sod must be held in place with stakes in all drainage ways, on slopes steeper than 4:1, and where directed. Pegging is done immediately after tamping. At least one stake is driven through each sod, but not less than 2 ft. (600 mm) apart. The stakes are driven flush with their flat sides against the slope.

2-1007D Finishing and Maintenance

The contractor must dispose of extra soil and sod in an approved manner. Soil should not be ridged next to the sod. Excess or rejected sod will not be paid for.

The contractor must maintain the sodded area until all work on the contract is accepted. This may involve:

- protecting the sodded area with signs or barricades,
- mowing grass to a height of 2 in. (50 mm) when it reaches 4 in. (100 mm),
- watering the sod as directed by the Engineer, and
- Repairing damaged areas of the sod.

2-1008 Plantings

2-1008A Coordination with Project Staff

The project staff will review all contract plans for all planting locations and note any conflicts with utilities or staging. The Landscape Design Unit (LDU) should be invited to the pre-construction meeting. In addition, this is the time to review the Contract for items such as Control and Removal of Invasive Vegetation, Tree Protection Root Pruning and other planting items

Tree Removal meeting should be scheduled prior to any contract work associated with this activity. The LDU should also be invited to the tree-removal meeting. The trees outside the project limits impacted by work should be noted by the Inspector and flagged prior to the meeting.

Prior to the Fall and Spring Planting seasons the staff should develop a tracking system for planting installation and inspection. This will enable staff to verify with the contractor what the warranty kick off dates.

The Inspector should also ensure that all plantings purchased from the nursery are planted by fall either in their permanent locations or temporarily so the plants may enter their dormant season. Throughout construction the Inspector should note any conflicts from change orders, areas of poor drainage, compaction from anti-tracking, contractor or maintenance access, etc. which could and are affect the plantings.

2-1008B Coordination Early in Planting Season

The Inspector will request the Contractor to send a Transmittal with an attached Source of Supply and Request for Plant Inspection to the LDU. Upon receipt of the Transmittal from LDU, the Transmittal shall be forwarded to the Contractor noting any unapproved planting species. Any planting substitution of plantings should be made through a Request for Change (RFC). Also, submittals for seeding shall be submitted to LDU for approval. The Inspector shall coordinate source visits, material certifications, samples and quantity tracking and mixing of organic material into topsoil.

Early in the planting season it is recommended the Inspector contact LDU to review field conditions and determine any corrective measures that need to be done. The Inspector shall review the specifications and coordinate seeding and soil preparation with the Contractor.

Once all corrective measures are addressed the Inspector shall schedule the plant layout and staging area (if applicable) with the Contractor and LDU. A notice of 1 week should be given to LDU prior to the plant layout. Again, the Inspector shall review the specifications, detail, and installation of plantings with LDU.

When plants are delivered to the project site it the Inspector's responsibility to check all rootballs and containers to ensure the soil is moist. Trunks and rootballs shall also be checked for possible damage that may have occurred either during loading or transporting the plants to the project. The Inspector shall verify that the plants are stored in a shady area and covered with mulch during staging. The Inspector must make sure that the plants are being watered regularly to maintain optimum health in the stockpiled area.

2-1008C Installation

The Inspector shall confirm the Contractor is measuring the depth of the pit against the height of the root ball during excavation. The planting depth shall be reviewed and assure the root flare is not visible due to excess soil over the ball. The plant pits should be checked for obstructions, asphalt, or standing water. If there are any obstructions, asphalt or standing water LDU should be consulted before planting. The Inspector shall verify that the soil below the required excavation depth remains undisturbed. If the soil has

been disturbed the area shall be tamped and more soil added if necessary. The plant pit shall be remeasured to assure it is 2” less than the height of the root ball.

When setting plants the Inspector should assure that the soil was mixed with organic material as per the contract specification. Any synthetic or non-biodegradable material (such as rope) shall be removed. The pit should be half filled with the planting mix and then well tamped around the ball remove any air pockets, which could cause shifting or settling. The pit shall be filled with water and allowed to drain. Any rope, burlap and excess soil should be removed so that the root flare is above finished grade. If a wire basket is present, the top 1/3 of the wire basket should be bent down, a cut made around the next tier of wire and remove the burlap from 1/3 to ½ of the ball, so that the roots can grow into the surrounding soil.

All trees shall be set straight and the pit filled with planting soil and then tamped once again to remove air pockets. A 6” tall saucer should be constructed around each tree trunk, capable of holding soaking water.

2-1008D Mulching

The woodchip mulch shall be placed as per the Contract details. The mulch shall be 2” away from the tree trunk and the base of all shrub stems should be exposed so that no rotting occurs.

2-1008E Watering

Water shall be applied at a controlled rate so that it percolates to the root zone of the tree. Water injection or bags may be substituted at the discretion of the Engineer, however this must be formally submitted and accepted. The Inspector shall review the Contractor’s schedule for watering and determine how the watering will be tracked by the Inspector.

2-1008F Staking and Guying

All of the trees shall be staked and guyed as per the Standard Details. Any other methods of staking and guying shall be formally submitted and accepted prior to installation.

2-1008G Semi-Final Inspection

At the time of the semi-final inspection, the Inspector shall verify that all plantings are installed and any areas damaged have been restored. A copy of the completed “Planting Checklist” in the Approved Forms folder shall be transmitted to LDU.

2-1008H Establishment Period and Punch List

The Inspector shall review the inventory of the dead, dying and otherwise unacceptable plant material and notify the Contractor to schedule replacement work and corrective measures. All planting areas shall be free of weeds and all stakes and wires removed.

LDU then shall be notified of the final walk-thru.

2-1008I Documentation of Visual Inspection by the Inspector

The Inspector shall record on their SiteManager Daily Work Report (DWR) all details concerning the planting process. It is recommended that a “zero” quantity be made under a typical planting item when planting work is performed to be able to produce a report with all planting details even if payment is not yet made. When LDU is onsite the Inspector shall note the name and LDU on the DWR under the “visitors” section of the DWR in SiteManager. Any dead, dying or unacceptable plants should be noted on a Non-

Compliance Notice to the Contractor and entered under the “Non-Compliance Notice” section on the DWR in SiteManger. A Compliance Notice is also required when the Non-Compliance issue has been resolved.

Figure 2-10.6 Tree Planting
Tree Planting Reference Card

