

**Final Report:  
Evaluation of Connecticut's Stormwater  
General Permits and Alternatives for  
Incorporation of Low Impact Development**

**Partners for the Connecticut  
Low Impact Development and  
Stormwater General Permit Evaluation**  
Connecticut

May 2011



146 Hartford Road  
Manchester, CT 06040

# Table of Contents

## Evaluation of Connecticut’s Stormwater General Permits to Promote Better Site Design and Incorporation of Low Impact Development Practices

### Partners for the Connecticut Low Impact Development and Stormwater General Permit Evaluation

---

<b>Executive Summary</b> .....	<b>1</b>
<b>1 Project Background</b> .....	<b>8</b>
1.1 Background .....	8
1.2 Purpose .....	8
<b>2 Coordination and Involvement by Interested Parties</b> .....	<b>10</b>
2.1 General Approach.....	10
2.2 Relationship of Partners to Overall Project Goals .....	10
2.3 Coordination with Partners .....	12
2.4 Partner Work Plan .....	13
2.4.1 Development Approach .....	14
2.4.2 Results.....	15
2.5 Partner Workshop Schedule and Topics.....	15
2.6 Workshop Outcomes .....	16
<b>3 Identification of Approaches for Including LID and Pollution Prevention in General Permits</b> .....	<b>16</b>
3.1 Review of Stormwater General Permits from Regulatory Agencies Outside of Connecticut.....	16
3.1.1 Methods of Collection .....	16
3.1.2 Permits Collected.....	16
3.1.3 Interviews with Stormwater Managers .....	17
3.1.4 Findings and Analysis of Permits .....	19
3.1.5 Summary of Findings by State .....	20
3.1.5.1 <i>Alaska</i> .....	20
3.1.5.1.1 General.....	20
3.1.5.1.2 General Permits .....	21
3.1.5.1.3 Performance Criteria .....	22
3.1.5.1.4 References .....	23
3.1.5.2 <i>Arizona</i> .....	23
3.1.5.2.1 General.....	23
3.1.5.2.2 General Permits .....	24
3.1.5.2.3 References .....	25
3.1.5.3 <i>California</i> .....	25
3.1.5.3.1 General.....	25
3.1.5.3.2 General Permits .....	26

# Table of Contents

## Evaluation of Connecticut’s Stormwater General Permits to Promote Better Site Design and Incorporation of Low Impact Development Practices

### Partners for the Connecticut Low Impact Development and Stormwater General Permit Evaluation

---

	3.1.5.3.3	Performance Criteria .....	27
	3.1.5.3.4	References .....	28
3.1.5.4	<i>Florida</i> .....		29
	3.1.5.4.1	General .....	29
	3.1.5.4.2	General Permits .....	30
	3.1.5.4.3	Performance Criteria .....	30
	3.1.5.4.4	References .....	30
3.1.5.5	<i>Idaho</i> .....		31
	3.1.5.5.1	General .....	31
	3.1.5.5.2	Performance Criteria .....	31
	3.1.5.5.3	References .....	32
3.1.5.6	<i>Maine</i> .....		33
	3.1.5.6.1	General .....	33
	3.1.5.6.2	General permits .....	34
	3.1.5.6.3	Performance Criteria .....	34
	3.1.5.6.4	References .....	35
3.1.5.7	<i>Massachusetts</i> .....		36
	3.1.5.7.1	General .....	36
	3.1.5.7.2	Performance Criteria .....	37
	3.1.5.7.3	References .....	37
3.1.5.8	<i>Minnesota</i> .....		38
	3.1.5.8.1	General .....	38
	3.1.5.8.2	General Permits .....	38
	3.1.5.8.3	Performance Criteria .....	39
	3.1.5.8.4	References .....	39
3.1.5.9	<i>Nevada</i> .....		40
	3.1.5.9.1	General .....	40
	3.1.5.9.2	General Permits .....	40
	3.1.5.9.3	Performance Criteria .....	41
	3.1.5.9.4	Additional Information .....	42
	3.1.5.9.5	References .....	43
3.1.5.11	<i>New Mexico</i> .....		43
	3.1.5.11.1	General .....	43
	3.1.5.11.2	Performance Criteria .....	44
	3.1.5.11.3	References .....	44

# Table of Contents

## Evaluation of Connecticut’s Stormwater General Permits to Promote Better Site Design and Incorporation of Low Impact Development Practices

### Partners for the Connecticut Low Impact Development and Stormwater General Permit Evaluation

---

3.1.5.12	<i>New Hampshire</i> .....	44
	3.1.5.12.1 General .....	44
	3.1.5.12.2 Alteration of Terrain (AoT) Permit .....	45
	3.1.5.12.3 Performance Criteria.....	45
	3.1.5.12.4 References.....	46
3.1.5.13	<i>New York</i> .....	46
	3.1.5.13.1 General .....	46
	3.1.5.13.2 General Permits.....	47
	3.1.5.13.3 Performance Criteria.....	48
	3.1.5.13.4 References.....	49
3.1.5.14	<i>Oklahoma</i> .....	49
	3.1.5.14.1 General .....	49
	3.1.5.14.2 General Permits.....	50
	3.1.5.14.3 Performance Criteria.....	51
	3.1.5.14.4 References.....	51
3.1.5.15	<i>Oregon</i> .....	51
	3.1.5.15.1 General .....	52
	3.1.5.15.2 General Permits.....	52
	3.1.5.15.3 Performance Criteria.....	53
	3.1.5.15.4 References.....	53
3.1.5.16	<i>Pennsylvania</i> .....	53
	3.1.5.16.1 General .....	54
	3.1.5.16.2 General Permits.....	54
	3.1.5.16.3 Performance Criteria.....	54
	3.1.5.16.4 References.....	55
3.1.5.17	<i>Rhode Island</i> .....	56
	3.1.5.17.1 General .....	56
	3.1.5.17.2 Performance Criteria.....	58
	3.1.5.17.3 References.....	59
3.1.5.18	<i>Vermont</i> .....	59
	3.1.5.18.1 General .....	60
	3.1.5.18.2 General Permits.....	60
	3.1.5.18.3 Performance Criteria.....	63
	3.1.5.18.4 References.....	63
3.1.5.19	<i>Washington</i> .....	64



# Table of Contents

## Evaluation of Connecticut’s Stormwater General Permits to Promote Better Site Design and Incorporation of Low Impact Development Practices

### Partners for the Connecticut Low Impact Development and Stormwater General Permit Evaluation

	3.1.5.19.1	General .....	64
	3.1.5.19.2	General Permits.....	65
	3.1.5.19.3	Performance Criteria.....	65
	3.1.5.19.4	References.....	66
3.1.5.20	<i>West Virginia</i> .....		66
	3.1.5.20.2	General .....	67
	3.1.5.20.3	Performance Criteria.....	68
	3.1.5.20.4	References.....	68
3.1.5.21	<i>Wisconsin</i> .....		69
	3.1.5.21.1	General .....	69
	3.1.5.21.2	General Permits.....	69
	3.1.5.21.3	Performance Criteria.....	70
	3.1.5.21.4	References.....	70
<b>3.2</b>	<b>Partner Recommendations.....</b>		<b>70</b>
3.2.1	Informing and Engaging Partners.....		70
3.2.2	Telephone Interviews.....		71
3.2.2.1	<i>Interview Process</i> .....		71
3.2.2.2	<i>Interview Questionnaire and Conversation</i> .....		71
3.2.2.3	<i>Findings</i> .....		72
	3.2.2.3.1	Are you Familiar with LID Practices? .....	72
	3.2.2.3.2	Have you been Involved in the Application of LID?.....	73
	3.2.2.3.3	How Should LID be Incorporated into DEP Policy?.....	73
	3.2.2.3.4	Should LID be the BMP of Choice? .....	74
	3.2.2.3.5	What Standards Should we use to Demonstrate the use of LID in Projects?.....	75
	3.2.2.3.6	Should we use Stormwater Utility Districts as a Regulatory Device? .....	76
	3.2.2.3.7	What would you like your Role to be in Implementing LID?.....	77
<b>3.3</b>	<b>Input from Workshops 1 and 2 .....</b>		<b>78</b>
3.3.1	Workshop 1 and 2 Card Storming .....		78
3.3.2	Workshop 2 Carousel Activity .....		82
<b>3.4</b>	<b>Applications in Connecticut .....</b>		<b>86</b>
3.4.1	Performance Goals and Criteria for LID/Pollution Prevention.....		86

# Table of Contents

## Evaluation of Connecticut's Stormwater General Permits to Promote Better Site Design and Incorporation of Low Impact Development Practices

### Partners for the Connecticut Low Impact Development and Stormwater General Permit Evaluation

---

3.4.2	Incorporating Performance Goals and Criteria in General Permits .....	87
3.4.3	Giving LID Priority Attention.....	88
3.4.4	Additional Suggestions for Elements of a LID Program .....	88
<b>4</b>	<b>Evaluating the Role of Stormwater Utilities.....</b>	<b>90</b>
4.1	<b>The Nature of Stormwater Utilities.....</b>	<b>90</b>
4.1.1	What is a Stormwater Utility District? .....	90
4.1.2	What Might Stormwater Utilities do in Connecticut? .....	91
4.1.2.1	<i>Connecticut's Current Status</i> .....	91
4.1.2.2	<i>Implementation in Other States</i> .....	92
4.1.2.3	<i>The Concept and Potential Benefits of Regionalization</i> .....	93
4.1.3	How Might Stormwater Utility Districts Help to Implement Low Impact Development? .....	94
4.1.4	What are the Disadvantages of Stormwater Utility Districts?.....	95
4.2	<b>When Should Stormwater Utilities be Considered? .....</b>	<b>96</b>
4.2.1	To a Large Extent, Financing Follows Function .....	96
4.2.2	More Than One Approach May Work.....	97
4.2.3	Adequacy of Potential Funding.....	98
4.3	<b>What Authority Exists in Connecticut to Implement Stormwater Utility Districts? .....</b>	<b>100</b>
4.4	<b>Input from Partners on Stormwater Utilities .....</b>	<b>100</b>
4.4.1	Interviews.....	101
4.4.2	Workshop 2 .....	102
4.4.3	Observations from Interviews and Workshop 2 .....	103
4.5	<b>Next Steps.....</b>	<b>104</b>
<b>5</b>	<b>Identifying Alternatives for Implementation and Selecting an Approach .</b>	<b>106</b>
5.1	<b>Summary of Alternatives.....</b>	<b>106</b>
5.1.1	Methods Used to Incorporate LID and Pollution Prevention .....	106
5.1.1.1	<i>Regulatory Alternatives</i> .....	107
5.1.1.1.1	Incorporating LID through Updates to the Stormwater Quality Manual and Soil and Erosion Guidelines .....	107
5.1.1.1.2	Establishing Standards in the Stormwater General Permits .....	108
5.1.1.1.3	Designer Licensing.....	110
5.1.1.1.4	Impervious Cover Cap and Trade.....	110

# Table of Contents

## Evaluation of Connecticut’s Stormwater General Permits to Promote Better Site Design and Incorporation of Low Impact Development Practices

### Partners for the Connecticut Low Impact Development and Stormwater General Permit Evaluation

---

	5.1.1.1.5	Adjusted Standards for Areas or Circumstances of Special Concern.....	111
5.1.1.2		<i>Nonregulatory Alternatives</i> .....	111
	5.1.1.2.1	Training Program .....	111
	5.1.1.2.2	Financial Incentives.....	112
	5.1.1.2.3	Technical Assistance .....	112
	5.1.1.2.4	Public Education .....	112
5.1.1.3		<i>Stormwater Utility Districts</i> .....	113
	5.1.1.3.1	Stormwater Utility Subcommittee .....	113
	5.1.1.3.2	Guidance Document.....	113
	5.1.1.3.3	Technical and Financial Assistance Program .....	113
	5.1.1.3.4	Public Outreach and Awareness Toolbox.....	114
	5.1.1.3.5	Delegation of Regulatory Authority.....	114
5.1.1.4		<i>Hybrid Option</i> .....	114
5.1.2		Incorporating LID Performance Goals and Criteria in General Permits ..	116
	5.1.2.1	<i>Partner Interviews</i> .....	116
	5.1.2.2	<i>Approaches Used by Other States</i> .....	117
	5.1.2.3	<i>Findings from Interactive Workshop Activities</i> .....	117
5.1.3		Methods for Giving LID Priority in Stormwater General Permits.....	118
<b>5.2</b>		<b>Rationale for Selection of Alternatives .....</b>	<b>119</b>
	5.2.1	Candidate Alternatives for Selection.....	119
	5.2.2	Selection Criteria .....	120
	5.2.3	Comparing Candidate Alternatives Using Selection Criteria and Data from Workshop 2 .....	120
<b>5.3</b>		<b>Selection of Alternatives in Cooperation with the Partners .....</b>	<b>123</b>
	5.3.1	Preparation for Workshop 3 .....	123
	5.3.2	Exploring Alternatives—Café Workshop.....	124
	5.3.3	Identifying Preferred Alternatives Based on Criteria—Dot Voting Using a Criteria Matrix .....	125
	5.3.4	Observations from the Dot-Voting and Previous Exercises .....	128
<b>6</b>		<b>Incorporating LID into Connecticut Guidance Manuals .....</b>	<b>129</b>
	6.1	Introduction to Low Impact Development .....	130
	6.2	LID Planning and Design Process.....	133

# Table of Contents

## Evaluation of Connecticut's Stormwater General Permits to Promote Better Site Design and Incorporation of Low Impact Development Practices

### Partners for the Connecticut Low Impact Development and Stormwater General Permit Evaluation

6.2.1	Basic Planning Principles .....	135
6.2.2	Site Planning and Design Process .....	137
6.2.2.1	<i>Step 1 – Define Basic Project Objectives and Goals</i> .....	137
6.2.2.2	<i>Step 2 – Site Evaluation and Analysis</i> .....	138
6.2.2.3	<i>Step 3 – Optimize Conservation of Natural Features at the Larger Watershed Scale</i> .....	138
6.2.2.4	<i>Step 4 – Minimize Impacts at the Lot Level</i> .....	139
<b>6.3</b>	<b>Use of Integrated Management Practices in Various Settings .....</b>	<b>141</b>
6.3.1	Integrated Management Practices in a Residential Setting .....	141
6.3.2	Integrated Management Practices for High Density Industrial, Commercial and Residential Development .....	142
6.3.3	LID Roadway Designs .....	144
6.3.3.1	<i>Open Section Roadways</i> .....	145
6.3.3.2	<i>CUL-DE-SAC Designs</i> .....	147
6.3.3.3	<i>Divided Highways</i> .....	147
6.3.3.4	<i>Highly Urbanized LID Street Design</i> .....	149
6.3.3.5	<i>Porous Surfaces</i> .....	150
6.3.3.6	<i>Other LID Roadway Design Considerations</i> .....	150
6.3.4	Urban Retrofit and Redevelopment .....	151
6.3.4.1	<i>Retrofit Case Studies</i> .....	152
<b>6.4</b>	<b>Design Standards for Low Impact Development Controls .....</b>	<b>155</b>
6.4.1	Approaches that Optimize Conservation .....	156
6.4.1.1	<i>Limits of Clearing and Grading</i> .....	156
6.4.1.2	<i>Preserving Natural Areas</i> .....	157
6.4.1.3	<i>Avoid Disturbing Long, Steep Slopes</i> .....	163
6.4.1.4	<i>Minimize Siting on Porous and Erodible Soils</i> .....	164
6.4.2	Approaches that Mimic Natural Water Balance .....	165
6.4.3	Approaches to Minimizing and Disconnecting Impervious Surface ...	169
6.4.3.1	<i>Roadways</i> .....	169
6.4.3.2	<i>Buildings</i> .....	171
6.4.3.3	<i>Parking Footprints</i> .....	173
6.4.3.4	<i>Parking Lot Islands</i> .....	175
6.4.3.5	<i>Permeable Pavement</i> .....	177
6.4.3.6	<i>Disconnecting Impervious Areas</i> .....	178
6.4.4	Integrated Management Practices at the Source .....	182
6.4.4.1	<i>Vegetated Filter Strips</i> .....	182
6.4.4.2	<i>Natural and Vegetated Drainage Ways</i> .....	183

# Table of Contents

## Evaluation of Connecticut's Stormwater General Permits to Promote Better Site Design and Incorporation of Low Impact Development Practices

### Partners for the Connecticut Low Impact Development and Stormwater General Permit Evaluation

---

6.4.4.3	<i>Green Roofs and Facades</i> .....	185
6.4.4.4	<i>Rain Barrels and Cisterns</i> .....	193
6.4.4.5	<i>Dry Wells</i> .....	194
6.4.4.6	<i>Bioretention and Rain Gardens</i> .....	195
6.4.4.7	<i>Infiltration Trenches</i> .....	196
<b>6.5</b>	<b>Overcoming Impediments to LID at the Local Level</b> .....	<b>197</b>
6.5.1	Vegetation and Landscaping .....	198
6.5.1.1	<i>Preservation of Natural Areas</i> .....	198
6.5.1.2	<i>Tree Protection Ordinances</i> .....	198
6.5.1.3	<i>Parking Lot Islands and Screening Ordinances</i> .....	198
6.5.1.4	<i>Riparian Buffers</i> .....	199
6.5.2	Minimizing Land Disturbance .....	199
6.5.2.1	<i>Limits of Disturbance</i> .....	199
6.5.2.2	<i>Open Space and Cluster Development</i> .....	200
6.5.3	Impervious Area Management.....	200
6.5.3.1	<i>Streets and Driveways</i> .....	200
6.5.3.2	<i>Parking Areas and Sidewalks</i> .....	201
6.5.3.3	<i>Unconnected Impervious Areas</i> .....	201
6.5.4	Vegetated Open Channels .....	202
<b>7</b>	<b>Results and Next Steps</b> .....	<b>202</b>
7.1	<b>Results</b> .....	<b>203</b>
7.1.1	Regulatory Programs .....	204
7.1.2	Nonregulatory Programs .....	204
7.1.3	Stormwater Utility Districts.....	205
7.2	<b>Next Steps</b> .....	<b>206</b>
7.2.1	Regulatory Programs .....	206
7.2.2	Nonregulatory Programs .....	207
7.2.3	Stormwater Utility Districts.....	208
7.3	<b>Recommended Schedule</b> .....	<b>209</b>
<b>8</b>	<b>References</b> .....	<b>210</b>

## Table of Contents

### Evaluation of Connecticut's Stormwater General Permits to Promote Better Site Design and Incorporation of Low Impact Development Practices

#### Partners for the Connecticut Low Impact Development and Stormwater General Permit Evaluation

---

<b>Tables</b>		<b>Page</b>
1.1	Summary of Project Deliverables	1 & 8
2.1	Potential Areas of Partner Interest	4 & 11
2.2	Workshop Schedule	15
3.1	Interview Contact List	18
3.2	Specific Standards Found in Alaska General Permits	20
3.3	Specific Standards Found in Arizona General Permits	23
3.4	Specific Standards Found in California General Permits	25
3.5	Specific Standards Found in Florida General Permits	29
3.6	Specific Standards Found in Idaho General Permits	31
3.7	Specific Standards Found in Maine General Permits	33
3.8	Specific Standards Found in Massachusetts General Permit	36
3.9	Specific Standards Found in Minnesota General Permits	38
3.10	Specific Standards Found in Nevada General Permits	40
3.11	Specific Standards Found in New Mexico General Permits	43
3.12	Specific Standards Found in New Hampshire General Permits	44
3.13	Specific Standards Found in New York General Permits	46
3.14	Specific Standards Found in Oklahoma General Permits	49
3.15	Specific Standards Found in Oregon General Permits	51
3.16	Specific Standards Found in Pennsylvania General Permits	53
3.17	Specific Standards Found in Rhode Island General Permits	56
3.18	Specific Standards Found in Vermont General Permits	59
3.19	Specific Standards Found in Washington General Permits	64
3.20	Specific Standards Found in West Virginia General Permits	66
3.21	Specific Standards Found in Wisconsin General Permits	69
3.22	Interviewee Reports of Experience with LID	73
3.23	Interviewee's Preference for type of LID Standard	74
3.24	Interviewee's Response to the Question "Should LID be the BMP of Choice?"	75
3.25	Interviewee's Response to the Question "How Should LID be Demonstrated?"	76
3.26	Interviewee's Response to Question "Should we use Stormwater Utility District As a Regulatory Device?"	77
3.27	Interviewee's Response to Question	78
4.1	Features of Seven Stormwater Utility Districts	93
4.2	Categories of Stormwater Financing Methods	97
4.3	Practical Considerations Related to General Taxation and Utility Fees as Sources of Revenue for Stormwater Management	98

# Table of Contents

## Evaluation of Connecticut's Stormwater General Permits to Promote Better Site Design and Incorporation of Low Impact Development Practices

### Partners for the Connecticut Low Impact Development and Stormwater General Permit Evaluation

<b>Tables (continued)</b>		<b>Page</b>
4.4	Typical Costs of Stormwater Management Programs Based on Acres Served and Level of Implementation	99
4.5	Interviewee's Response to the Question "Should we use Stormwater Utility Districts as a Regulatory Device?"	102
5.1	Summary of General Alternatives and Criteria for Decision Making	121
5.2	Results of Dot-Voting	127
6.1	Cost Analysis for Conventional and Alternative Development	133
6.2	General Guidance for Narrower Roadways	147
6.3	Ratio of Forested Buffer to Impervious Surface Required to Attenuate Runoff for Precipitation between 0.5 and 1.0 Inches	162
6.4	Hydrologic Benefits of Nonstructural and Distributed Techniques and Controls	167
6.5	Roadway Design Standards for Five Street Types	171
6.6	Recommended Maximum Number of Parking Spaces for Certain Land Uses	175
6.7	Ratio of Open Space: Impervious to Necessary Attenuate Surface Runoff for Runoff Between 0.5 and 1.0 Inches	179
6.8	Typical Maintenance Activities for Rooftop Runoff Structures	192
<b>Figures</b>		<b>Page</b>
5.1	Flow Diagram of Hypothetical Hybrid Option	115
5.2	Café workshop in Progress	125
5.4	DOT Voting workshop in progress	126
5.5	DOT voting results	127
5.2.3	Café Station Set-Up	125
6.2.1	Conventional Controls	134
6.2.2	LID Controls	134
6.2.3	Key elements of LID	135
6.2.4	Integration of resource conservation into a conventional design	137
6.2.5	Optimizing the use of green space	138
6.2.6	Conventional approach of draining runoff to the streets vs. a LID design using site fingerprinting	139
6.2.7	Lot level techniques	140
6.3.1	Schematic of engineered practices	141
6.3.2	LID design strategies for office buildings, small commercial buildings, and big box sites	143
6.3.3	Schematic example of engineered practices in an urban retrofit streetscape	144
6.3.4	Open section roadways	145



## Table of Contents

### Evaluation of Connecticut's Stormwater General Permits to Promote Better Site Design and Incorporation of Low Impact Development Practices

#### Partners for the Connecticut Low Impact Development and Stormwater General Permit Evaluation

<b>Figures (continued)</b>	<b>Page</b>
6.3.5 Narrow road section with sidewalks, shallow swale and porous pavement shoulders	146
6.3.6 Swale design to enhance its ability to filter and infiltrate runoff	146
6.3.7 Cul-de-sac designs	147
6.3.8 Examples of center median infiltration/filtration systems	148
6.3.9 Shoulder Treatment Systems using detention and filtration design	149
6.3.10 Examples of planter box designs in high density development	149
6.3.11 Porous surfaces	150
6.3.12 Permeable pavement and rain garden/bioretention retrofits along North Main Street in Bridgeport, CT	152
6.3.13 Green roof on subsurface building at Hartford Green Capitols Project	153
6.3.14 Construction of a rain garden at Hartford Green Capitols Project.	153
6.3.15 Permeable pavement at Hartford Green Capitols Project.	153
6.3.16 Retrofit and redevelopment techniques in Connecticut	154
6.4.1 Reduced limits of disturbance minimize water quality impacts	157
6.4.2 Site map with natural areas delineated	158
6.4.3 Riparian buffer along the French River, in Thompson, CT	159
6.4.4 Three-zone riparian buffer	159
6.4.5 Rock trench level spreader for low flows	161
6.4.6 Building on flatter slopes reduces the impact of development	163
6.4.7 Site plans depicting hydrologic soil groups	164
6.4.8 Alternative roadway design in Waterford, CT.	168
6.4.9 Different styles of turnarounds	169
6.4.10 Cul-de-sac infiltration island accepts stormwater from surrounding pavement	170
6.4.11 Reduced road widths	170
6.4.12 Reduced side yards	172
6.4.13 Examples of nontraditional lot designs	173
6.4.14 Parking deck – New Haven, CT	175
6.4.15 Bioretention in a parking lot island in Branford, CT	176
6.4.16 Parking lot with islands attractively integrated	176
6.4.17 Permeable pavement	177
6.4.18 Standards for disconnecting impervious surface via sheet flow	180
6.4.19 Standards for disconnecting impervious surface via downspouts	181
6.4.20 Vegetative filter strip	182
6.4.21 Drawing of a vegetative filter strip	183



# Table of Contents

## Evaluation of Connecticut’s Stormwater General Permits to Promote Better Site Design and Incorporation of Low Impact Development Practices

### Partners for the Connecticut Low Impact Development and Stormwater General Permit Evaluation

<b>Figures (continued)</b>		<b>Page</b>
6.4.22	Vegetated drainage way	183
6.4.23	Aetna Building, Hartford, CT	185
6.4.24	Roof ponding rings	190
6.4.25	Example Vegetated Rooftop Cross-section	192
6.4.26	Example of a rain barrel	193
6.4.27	Schematic of a drywell with optional sump to facilitate cleanout	194
6.4.28	Bioretention at University of Connecticut Storrs Campus –Mansfield, CT.	195
6.4.29	Rain garden	196
6.4.30	Infiltration trench	196
 <b>Photographs</b>		 <b>Page</b>
3.1	Sticky Wall after first round of postings and pairing.	79
3.2	Groups or “clusters” of card storming answers being assigned shapes.	79
3.3 -3.6	Carousel workshop in process	83 & 84
5.1	Café Workshop in Process	124
5.2	Café Station Setup	124
5.3	Dot-Voting Workshop in Process	126
5.4	Dot-Voting Results	126
 <b>Appendices</b>		 <b>End of Report</b>
A	Letter to Partners	
B	Project Website	
C	Summary of Workshop 1	
D	Summary of Workshop 2	
E	Summary of Workshop 3	
F	Summary of Workshop 4	
G	Summary of Workshop 5	
H	State Interview Questionnaire	
I	Partner Interview Questionnaire	
J	ORL Research Report—Stormwater Utilities	

## Executive Summary

The Connecticut Department of Environmental Protection (DEP) has facilitated a partnership to help initiate a project to explore inclusion of low impact development (LID) within its four stormwater general permits (SGPs)—construction, municipal separate storm sewer systems (MS4s), industrial, and commercial—as well as the DEP *Soil Erosion and Sediment Control Guideline* and the DEP *Stormwater Quality Manual*.

The intent of this project is to evaluate improved and innovative approaches for more effectively controlling stormwater quantity and quality through Connecticut’s four SGPs. Goals and objectives include:

- Establishing performance goals and criteria for management practices common to GP implementation.
- Identifying how the performance goals and criteria can be most effectively incorporated into the SGPs to meet permit limits and conditions.
- Identifying mechanisms for incorporation of LID best management practices (BMPs), and pollution prevention practices into SGPs for priority attention.

This is the final project report and serves to integrate the findings and results of workshops,<sup>1</sup> interviews, and research conducted throughout the project. This project included the deliverables and tasks listed in *Table 1.1* (below).

**Table E.1  
Summary of Project Deliverables**

<b>Project Tasks</b>	<b>Deliverables</b>
Task 1— Project Initiation	<ul style="list-style-type: none"> <li>• Project Initiation Meeting agenda and minutes</li> <li>• List of work team members</li> <li>• Work team briefing</li> <li>• Work Team Meeting 1</li> <li>• Tabular List of potential partners</li> <li>• Draft interview form</li> <li>• Work Team Meeting Agenda and Minutes</li> <li>• Project Webpage launched.</li> <li>• Partner email group</li> </ul>
Task 2— Identify Approaches	<ul style="list-style-type: none"> <li>• Summary of information gathered from other states</li> <li>• Summary of information gathered from the Partners</li> </ul>

---

<sup>1</sup> To the extent possible, this draft final report has been written as though Workshop 5 has already been held. This will facilitate development of the final version of the Final Report.

<b>Project Tasks</b>	<b>Deliverables</b>
	<ul style="list-style-type: none"> <li>• Partner Workshop 1</li> <li>• Partner Workshop 1 Agenda and Minutes</li> <li>• Criteria for alternatives selection</li> <li>• Technical Memorandum 1—<i>Identification of Approaches for Including Low Impact Development and Pollution Prevention in General Permits</i></li> </ul>
Task 3— Stormwater Utilities	<ul style="list-style-type: none"> <li>• Summary of the role of stormwater utilities</li> <li>• Partner Workshop 2</li> <li>• Partner consensus on alternatives for further consideration under Task 4</li> <li>• Partner Workshop 2 agenda and minutes</li> <li>• Technical Memorandum 2—<i>Evaluating the Role of Stormwater Utility Districts in the Implementation of LID</i></li> </ul>
Task 4— Selection of Alternatives	<ul style="list-style-type: none"> <li>• Summary of alternative scenarios</li> <li>• Partner Workshop 3</li> <li>• Partner Workshop 3 agenda and minutes</li> <li>• Technical Memorandum 3—<i>Rationale for the Selection of Alternative Scenarios for Implementation</i></li> </ul>
Task 5— Connecticut's Guidance	<ul style="list-style-type: none"> <li>• Write-up of draft LID standards</li> <li>• Partner Workshop 4</li> <li>• Partner Workshop 4 Agenda and Minutes</li> <li>• Technical Memorandum 4—<i>Low Impact Development Guidelines and Standards</i></li> </ul>
Task 6—Final Report	<ul style="list-style-type: none"> <li>• Draft Final Report</li> <li>• Partner Workshop 5</li> <li>• Partner Workshop 5 Agenda and Minutes</li> <li>• Final Report</li> <li>• Partner work plan</li> </ul>

Much of this project included involvement by interested parties, and partners who could potentially aid DEP in meeting project goals. The general approach for engendering partner involvement is provided in *Section 2.1*.

A full list of agencies represented during the workshops includes:

- Advanced Drainage Systems
- Aquarion Water Co.
- Camp, Dresser, McKee (CDM)
- Central Connecticut Regional Planning Agency (CCRPA)
- Connecticut Business & Industry Association (CBIA)
- Connecticut Chapter of the American Planning Association (CCAPA)
- Council of Governments Central Naugatuck Valley
- Connecticut Associated Builders & Contractors
- Connecticut Concrete
- Connecticut Construction Industries
- Connecticut Department of Environmental Protection
- Connecticut Department of Health
- Connecticut Department of Transportation
- Connecticut Fund for the Environment
- Connecticut Home Builders
- Connecticut Office of Policy and Management
- Eastern Connecticut Conservation District (ECCD)
- United States Environmental Protection Agency (EPA) Region 1
- Fairfield Engineering
- Fuss & O'Neill
- Home Builders Association of Connecticut
- LID Institute
- Luchs
- Metropolitan District (MDC)
- Milone & MacBroom Inc.
- Murtha Cullina, LLP
- Northwest Conservation District
- O & G Industries, Inc.
- Regional Water Authority
- Rivers Alliance
- Rivers Alliance, Sierra
- Save The Sound/CFE
- South Western Regional Planning Agency
- The Nature Conservancy
- Town of Greenwich

- University of Connecticut – Nonpoint Education for Municipal Officials

Five partner workshops were held between May and December 2010. Each meeting was held from 9:15 a.m. – 11:45 a.m. in the Phoenix Auditorium, CT DEP, 79 Elm Street, Hartford, CT. The table below summarizes when each meeting was held and topics covered.

**Table E.2  
Workshop Schedule**

<b>Workshop Title</b>	<b>Date Held</b>	<b>Topics</b>
Partner Workshop 1	Wednesday May 26, 2010	<ul style="list-style-type: none"> <li>• Project Initiation</li> <li>• Partner work plan</li> <li>• Criteria for alternatives selection</li> <li>• Summary of information gathered from other states</li> <li>• Summary of Information gathered from the Partners</li> <li>• Webpage</li> </ul>
Partner Workshop 2	Thursday July 1, 2010	<ul style="list-style-type: none"> <li>• Summary of the role of stormwater utilities</li> <li>• Partner consensus on three to five alternatives for further consideration</li> </ul>
Partner Workshop 3	Tuesday August 31, 2010	Summary of 3-5 alternative scenarios
Partner Workshop 4	Wednesday October 20, 2010	Write-up of draft LID standards
Partner Workshop 5	Wednesday, December 15, 2010	Draft Final Report

Workshop summaries were developed for each partner workshop. Summaries are provided in *Appendix C – G*. Outcomes of partner workshops are also discussed throughout this report. Recommendations for next steps and schedule for implementation are summarized below in terms of regulatory, nonregulatory, and stormwater utility district initiatives. Many of the schedule dates are uncertain at this time and are listed as to be develop, i.e., “TBD.” We expect that the dates will be better defined during subsequent phases of Connecticut’s low impact development implementation initiative.

### *Regulatory Programs*

DEP intends to develop a LID guidance for inclusion as an appendix to the existing Stormwater Quality Manual and Soil Erosion and Sediment Control Guideline, initiating in winter 2011. Further, DEP anticipates developing a full update to the *Stormwater Quality Manual* and *Soil Erosion and Sediment Control Guideline*.

As part of the LID guidance, DEP intends to develop adjusted standards for areas of special concern and incorporate these into the update of their stormwater manual/guidelines and the SGPs.

A number of states include flexibility in their stormwater management standards to address atypical circumstances. In some cases, adjusted standards are intended to be more highly protective of sensitive resources. In other cases, the standards are relaxed to encourage infill development or to reduce the burden of stormwater management in areas where it yields diminishing return. Some examples of adjusted management standards include:

- Standards designed to achieve pollutant load reductions for impaired water resources.
- Nitrogen management requirements for nitrogen-sensitive resources such as Long Island Sound or drinking water aquifers.
- Relaxed impervious cover allowances in highly urbanized settings.
- Graduated recharge requirements based on hydrologic soil group.

As a next step, DEP may wish to establish adjusted management standards for areas of special concern.

### *Nonregulatory Programs*

During the selection of alternatives, documented in Workshop 3 the partners identified several nonregulatory alternatives as priorities for implementation. These included:

- Training programs
- Technical assistance
- Public education

### *Stormwater Utility Districts*

During Workshop 3, development of a stormwater utility guidance document was identified as a priority for implementation. Development of a stormwater utility guidance document was described in *Section 5.1.1.3.2* of this report as follows:

Prior to pursuing stormwater utility districts at any governmental level, an approach to fee-setting and bureaucratic structure should be considered. It may be helpful to develop a model stormwater utility district ordinance and guidance manual for utility district development and implementation in Connecticut.

This discussion also points out that:

To ensure usefulness, guidance materials should be vetted through a test group of likely users of the guidance document. A subcommittee, such as the one described in *Section 2.1.4.1*, would make a good test group.

A description of this subcommittee is provided in *Section 5.1.1.3.1* of this Final Report. It states:

Implementation of stormwater utility districts in Connecticut will necessitate development of significant new policy, programs, and administrative structures. To make new policy, programs, and administrative structures efficient and service oriented, proponents from different levels of government and interested municipalities may wish to meet in a subcommittee to identify opportunities to cooperate in developing common approaches.

Also as discussed in Section 5.3.4:

Development of a stormwater utility “guidance document” was one of the five top-rated alternatives. Development of stormwater utility enabling legislation would probably be necessary to make the stormwater utility guidance document meaningful.

Therefore, this report recommends that if a stormwater utility guidance document is pursued that it should be developed in conjunction with enabling legislation and in the context of a subcommittee.

*Recommended Schedule*

The following table presents a proposed schedule for completing the action items identified in *Section 7.2*.

**Table E.3  
Recommended Implementation Schedule**

<b>Action Item</b>	<b>Approximate Completion Timeframe</b>
<b>Regulatory</b>	
<ul style="list-style-type: none"> <li>Develop a LID guidance for inclusion as an appendix to the existing Stormwater Quality Manual and Soil Erosion and Sediment Control Guideline.</li> </ul>	March 2011
<ul style="list-style-type: none"> <li>Step 2—Develop a Full update to the <i>Stormwater Quality Manual</i> and <i>Soil Erosion and Sediment Control Guideline</i>.</li> </ul>	2014

Action Item	Approximate Completion Timeframe
<ul style="list-style-type: none"> <li>• Establish adjusted management standards for areas of special concern.</li> </ul>	March 2011
<b>Nonregulatory</b>	
<ul style="list-style-type: none"> <li>• Develop a program to provide training, technical assistance, and public education for implementing LID alternatives.</li> </ul>	TBD <sup>1</sup>
<ul style="list-style-type: none"> <li> <ul style="list-style-type: none"> <li>○ Training programs</li> </ul> </li> </ul>	TBD
<ul style="list-style-type: none"> <li> <ul style="list-style-type: none"> <li>○ Technical assistance program</li> </ul> </li> </ul>	TBD
<ul style="list-style-type: none"> <li> <ul style="list-style-type: none"> <li>○ Public education</li> </ul> </li> </ul>	TBD
<b>Stormwater Utilities</b>	
<ul style="list-style-type: none"> <li>• Conduct legal research to determine legal feasibility of establishing stormwater utility districts through existing regional authorities such as water utilities, wastewater authorities, fire districts, etc.</li> </ul>	TBD
<ul style="list-style-type: none"> <li>• Establish a subcommittee to oversee development of enabling legislation and a stormwater utility district guidance document.</li> </ul>	TBD
<ul style="list-style-type: none"> <li>• Draft stormwater utility district enabling legislation</li> </ul>	TBD
<ul style="list-style-type: none"> <li>• Develop a model stormwater utility district ordinance and guidance manual for utility district development and implementation in Connecticut.</li> </ul>	TBD
<ul style="list-style-type: none"> <li> <ul style="list-style-type: none"> <li>○ Establish fee setting structure.</li> </ul> </li> </ul>	TBD
<ul style="list-style-type: none"> <li> <ul style="list-style-type: none"> <li>○ Establish bureaucratic and administrative structure.</li> </ul> </li> </ul>	TBD
<ul style="list-style-type: none"> <li> <ul style="list-style-type: none"> <li>○ Establish process to build public understanding and acceptance.</li> </ul> </li> </ul>	TBD

1. Notes: TBD = to be determined. Many of the completion timeframes are listed as “TBD.” Additional strategic planning with the partner subcommittees will be needed to better define these timeframes.



# 1 Project Background

## 1.1 Background

DEP has facilitated a partnership to help initiate a project to explore inclusion of LID within its four SGPs—construction, municipal separate storm sewer systems, industrial, and commercial—as well as the DEP *Soil Erosion and Sediment Control Guideline* and the DEP *Stormwater Quality Manual*.

The intent of this project is to evaluate improved and innovative approaches for more effectively controlling stormwater quantity and quality through Connecticut’s four SGPs. Goals and objectives include:

- Establish performance goals and criteria for management practices common to GP implementation.
- Identify how the performance goals and criteria can be most effectively incorporated into the SGPs to meet permit limits and conditions.
- Identify mechanisms for incorporation of LID BMPs, and pollution prevention practices into SGPs for priority attention.

## 1.2 Purpose

This is the final project report and serves to integrate the findings and results of workshops, interviews, and research conducted throughout the project. This project included the deliverables and tasks listed in *Table 1.1* (below).

**Table 1.1  
Summary of Project Deliverables**

Project Tasks	Deliverables
Task 1—Project Initiation	<ul style="list-style-type: none"> <li>• Project Initiation Meeting agenda and minutes</li> <li>• List of work team members</li> <li>• Work team briefing</li> <li>• Work Team Meeting 1</li> <li>• Tabular List of potential partners</li> <li>• Draft interview form</li> <li>• Work Team Meeting Agenda and Minutes</li> <li>• Project Webpage launched.</li> <li>• Partner email group</li> </ul>
Task 2—Identify Approaches	<ul style="list-style-type: none"> <li>• Summary of information gathered from other states</li> <li>• Summary of information gathered from the Partners</li> </ul>

Project Tasks	Deliverables
	<ul style="list-style-type: none"> <li>• Partner Workshop 1</li> <li>• Partner Workshop 1 Agenda and Minutes</li> <li>• Criteria for alternatives selection</li> <li>• Technical Memorandum 1—<i>Identification of Approaches for Including Low Impact Development and Pollution Prevention in General Permits</i></li> </ul>
Task 3— Stormwater Utilities	<ul style="list-style-type: none"> <li>• Summary of the role of stormwater utilities</li> <li>• Partner Workshop 2</li> <li>• Partner consensus on alternatives for further consideration under Task 4</li> <li>• Partner Workshop 2 agenda and minutes</li> <li>• Technical Memorandum 2—<i>Evaluating the Role of Stormwater Utility Districts in the Implementation of LID</i></li> </ul>
Task 4—Selection of Alternatives	<ul style="list-style-type: none"> <li>• Summary of alternative scenarios</li> <li>• Partner Workshop 3</li> <li>• Partner Workshop 3 agenda and minutes</li> <li>• Technical Memorandum 3—<i>Rationale for the Selection of Alternative Scenarios for Implementation</i></li> </ul>
Task 5— Connecticut's Guidance	<ul style="list-style-type: none"> <li>• Write-up of draft LID standards</li> <li>• Partner Workshop 4</li> <li>• Partner Workshop 4 Agenda and Minutes</li> <li>• Technical Memorandum 4—<i>Low Impact Development Guidelines and Standards</i></li> </ul>
Task 6—Final Report	<ul style="list-style-type: none"> <li>• Draft Final Report</li> <li>• Partner Workshop 5</li> <li>• Partner Workshop 5 Agenda and Minutes</li> <li>• Final Report</li> <li>• Partner work plan</li> </ul>

## 2 Coordination and Involvement by Interested Parties

---

### 2.1 General Approach

Much of this project included involvement by interested parties, and partners who could potentially aid DEP in meeting project goals. The general approach for engendering partner involvement is provided below:

- A list of potential partners and how they link to project goals (See *Section 2.2*) was prepared. The list of partners was modified to accommodate project needs and partner interests.
- Partners were made aware of the low-impact development and stormwater general permit evaluation through a letter and email sent on May 12, 2010 (*Appendix A*).
- A webpage and email group was developed to create feedback loops for partners and the interested public. The webpage can be located at [http://www.ct.gov/dep/cwp/view.asp?a=2719&q=459488&depNav\\_GID=1654](http://www.ct.gov/dep/cwp/view.asp?a=2719&q=459488&depNav_GID=1654). A copy of the webpage, as of December 8, 2010,<sup>2</sup> is provided as *Appendix B* and *Section 2.3* provides more information on both of these media.
- Partner workshops were conducted to review work products and project issues. *Section 2.5* identifies the workshop meeting schedule and topics covered at each meeting. *Section 2.6* references workshop outcomes. Following each meeting, meeting minutes were drafted to document meeting results. Meeting minutes were subsequently posted to the project webpage.

### 2.2 Relationship of Partners to Overall Project Goals

At the outset of the project, DEP and Fuss & O'Neill collaborated to select potential project partners (i.e., groups and agencies with specific interest and expertise in Connecticut stormwater management issues). Partners were selected based on interest and expertise in three areas of stormwater management. The table below provides the initial list of potential project partners and their relationships to the project goals.

---

<sup>2</sup> To be updated following Workshop 5.

**Table 2.1  
Potential Areas of Partner Interest**

<b>Potential Partner</b>	<b>LID Performance goals</b>	<b>Incorporate LID into SGPs</b>	<b>Role of Stormwater Utilities</b>
Connecticut Stormwater Program	✓	✓	✓
Nonpoint Source Program	✓	✓	✓
Office of Long Island Sound Program	✓		
United States Environmental Protection Agency	✓	✓	✓
CT Business Industries Association	✓	✓	
CT Construction Industries Association	✓	✓	
Marine Trades Association		✓	
CT Fund for the Environment	✓	✓	✓
LID grant recipient municipalities	✓	✓	✓
Water supply utilities (pick one or two larger utilities)	✓	✓	✓
Connecticut Conference of Municipalities	✓	✓	✓
UConn NEMO	✓		✓
CT Department of Health Services	✓	✓	
CT Home Builders	✓	✓	
CT Department of Transportation	✓	✓	✓
NRCS & Conservation Districts	✓	✓	✓
CT Regional Council of Governments	✓	✓	✓
SW CT Regional Planning Agency	✓		✓
Governor's Responsible Growth Task Force	✓		
Tolland, CT	✓	✓	✓

Additional partners were invited to participate throughout the project. A full list of agencies represented during the workshops includes:

- Advanced Drainage Systems
- Aquarion Water Co.
- Camp, Dresser, McKee (CDM)
- Central Connecticut Regional Planning Agency (CCRPA)
- Connecticut Business & Industry Association (CBIA)
- Connecticut Chapter of the American Planning Association (CCAPA)
- Council of Governments Central Naugatuck Valley
- Connecticut Associated Builders & Contractors
- Connecticut Concrete
- Connecticut Construction Industries
- Connecticut Department of Environmental Protection
- Connecticut Department of Health
- Connecticut Department of Transportation
- Connecticut Fund for the Environment
- Connecticut Home Builders
- Connecticut Office of Policy and Management
- Eastern Connecticut Conservation District (ECCD)
- United States Environmental Protection Agency (EPA) Region 1
- Fairfield Engineering
- Fuss & O'Neill
- Home Builders Association of Connecticut
- LID Institute
- Luchs
- Metropolitan District (MDC)
- Milone & MacBroom Inc.
- Murtha Cullina, LLP
- Northwest Conservation District
- O & G Industries, Inc.
- Regional Water Authority
- Rivers Alliance
- Rivers Alliance, Sierra
- Save The Sound/CPE
- South Western Regional Planning Agency
- The Nature Conservancy
- Town of Greenwich
- University of Connecticut – Nonpoint Education for Municipal Officials

---

## **2.3 Coordination with Partners**

DEP used a variety of media and methods to engage partners. Partners were initially made aware of the Low-Impact Development and Stormwater General Permit Evaluation initiative

through a letter and email sent on May 12, 2010. This letter is provided in *Appendix A* of this document. In particular, the letter announces an initiation meeting. Four other partner workshops were held during this project (see *Section 2.5*, below, for a general discussion of these meetings).

DEP established a project webpage, which may be accessed at:

[http://www.ct.gov/dep/cwp/view.asp?a=2719&q=459488&depNav\\_GID=1654](http://www.ct.gov/dep/cwp/view.asp?a=2719&q=459488&depNav_GID=1654)

The webpage, as of December 8, 2010, is provided as *Appendix B*. This webpage was used to provide important project information, such as:

- Workshop agendas and summaries
- Workshop presentations
- Project reports and other related materials

Beyond the workshops, webpage, and project announcements, partners were interviewed one-on-one over the telephone. While one-on-one interaction can occur at workshops, individual conversations provide a more personalized opportunity for direct feedback. Therefore, as a starting point to the project, telephone interviews were conducted for the specific purpose of requesting partner ideas on how to best develop and implement LID policy.

## 2.4 Partner Work Plan

The purpose of the partner work plan is to allow the project partners (i.e., participants in the project) the opportunity to self-identify issues and work that they would like to be involved with related to development of LID policy and implementation strategies. Generally, implementation strategies focused on those alternatives identified through Workshop 3 (see *Section 5.3* of this report); however, any LID policy implementation strategies could be included. *Sections 2.4.1* and *2.4.2* discuss the development of the partner work plan and the resulting work plan as of the writing of this report. A complete work plan was not generated. It was recognized at the outset that completion of the work plan would likely occur during a follow-on workshop (yet to be scheduled).

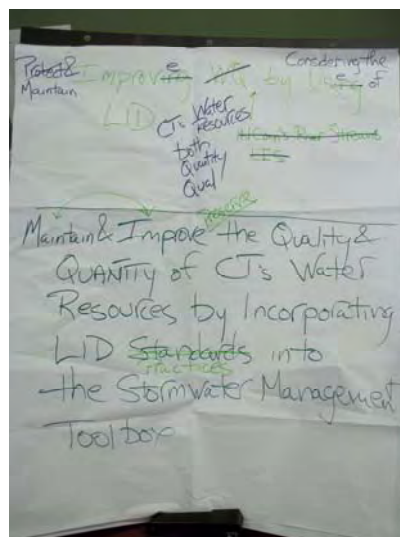

Photograph 2.1 – Commitment statement from Workshop 5

## 2.4.1 Development Approach

Development of the Partner Work Plan was initiated as part of Workshop 5. Partners undertook three steps as part of Workshop 5:

- Development of a group commitment.
- Identification of key actions for the workplan.
- Scheduling of calendar timeframes for completion of key actions.

### *Commitment Statement*

For the purposes of this exercise a commitment statement is akin to a mission statement for an organization. It represents the Project Partner's agreed-to strategic purpose. The following "commitment statement" was developed by the partners:

*Improve, maintain, and preserve the quality and quantity of Connecticut's water resources by incorporating LID practices into the stormwater management toolbox.*

This statement was developed with the full group of Workshop 5 participants during an open discussion. Photograph 2.1 shows the commitment statement as it was drawn up on a flip chart during this exercise.

### *Card Storming*

Card storming with the Workshop 5 participants was used to identify key actions needed to implement four of the five priority alternatives identified as a result of the dot voting in Workshop 3 (see *Table 5.2*). The priority LID implementation alternatives included:

- Training program
- Technical assistance
- Public education
- Stormwater utility guidance document



**Photograph 2.2** – Clustering alternatives at Workshop 5

“Adjusted standards for areas of special concern” (the fifth priority) was not included in this exercise as adjusted standards will be incorporated when DEP updates the *Stormwater Quality Manual* and *Soil Erosion and Sediment Control Guideline*. Update of these manuals is planned for the spring of 2011.

The actions were then clustered under four alternatives (public education, technical assistance, training, and stormwater utilities). Several actions were also identified that did not fall under the four alternatives. These were clustered under an unnamed group.

## 2.4.2 Results

To be developed.

## 2.5 Partner Workshop Schedule and Topics

Five partner workshops were held between May and December 2010. Each meeting was held from 9:15 a.m. – 11:45 a.m. in the Phoenix Auditorium, CT DEP, 79 Elm Street, Hartford, CT. The table below summarizes when each meeting was held and topics covered.

**Table 2.2  
Workshop Schedule**

<b>Workshop Title</b>	<b>Date Held</b>	<b>Topics</b>
Partner Workshop 1	Wednesday, May 26, 2010	<ul style="list-style-type: none"> <li>• Project Initiation</li> <li>• Partner work plan</li> <li>• Criteria for alternatives selection</li> <li>• Summary of information gathered from other states</li> <li>• Summary of Information gathered from the Partners</li> <li>• Webpage</li> </ul>
Partner Workshop 2	Thursday, July 1, 2010	<ul style="list-style-type: none"> <li>• Summary of the role of stormwater utilities</li> <li>• Partner consensus on three to five alternatives for further consideration</li> </ul>
Partner Workshop 3	Tuesday, August 31, 2010	Summary of 3-5 alternative scenarios
Partner Workshop 4	Wednesday, October 20, 2010	Write-up of draft LID standards
Partner Workshop 5	Wednesday, December 15, 2010	Draft Final Report



---

## 2.6 Workshop Outcomes

Workshop summaries were developed for each partner workshop. Summaries are provided in *Appendix C – G*. Outcomes of partner workshops are also discussed throughout this report.

# 3 Identification of Approaches for Including LID and Pollution Prevention in General Permits

---

## 3.1 Review of Stormwater General Permits from Regulatory Agencies Outside of Connecticut

*Section 3.1.5* provides a summary of information gathered from 22 states regarding construction, MS4s, industrial and commercial stormwater general permits.

### 3.1.1 Methods of Collection

For this summary, information was collected using two general methods:

- Web searches and state web page mining – This method involved using search engines such as Google to track down basic information about each state’s stormwater program. Once general permits and other basic information were collected, researchers reviewed the information and investigated references cited.
- Interviewing state stormwater managers – These interviews were conducted by telephone using an interview questionnaire (see *Appendix H*). As the primary purpose was to collect information, interviewers did not necessarily adhere to the form exactly, but instead used it as a structural and conversational tool.

### 3.1.2 Permits Collected

Information was collected through web research and interviews of 22 states. A list of references from each state (i.e., documents found to contain information about state stormwater programs and their use of LID) are provided at the end of each state discussion.

Researchers focused in particular on the four basic GPs for stormwater—construction, MS4, industrial, and commercial—and analysis aimed to identify specific information about the inclusion of LID and pollution control standards as well as runoff volume as an indicator of environmental quality and as a proxy for pollution concentration.<sup>4</sup>

---

<sup>4</sup> Control of certain volumes of runoff are often assumed to result in certain levels of pollution control. For example, states commonly use control of one-inch of runoff as a proxy for treatment of 80% of total suspended solids.

The following states were included in the review:

- Alaska
- Arizona
- California
- Florida
- Idaho
- Maine
- Maryland
- Massachusetts
- Minnesota
- Nevada
- New Mexico
- New Hampshire
- New York
- Oklahoma
- Oregon
- Pennsylvania
- Rhode Island
- Vermont
- Virginia
- Washington
- West Virginia
- Wisconsin

### 3.1.3 Interviews with Stormwater Managers

Investigators conducted 15 interviews with state stormwater managers and specialists by phone. Investigators attempted to contact stormwater managers and specialists from each of the 22 states listed in *Section 3.1.2* above. At least two attempts were made to contact each manager. (Additional attempts were made in cases where state contacts returned calls and left messages, but did not speak to investigators directly.) If no response was received through two contact attempts, further contact attempts were ceased.

As indicated in *Section 3.1.1*, investigators used an interview sheet to loosely structure conversations with state stormwater managers. The purpose of the interview sheet was to help collect parallel information from each state and to facilitate conversations with interviewees. As investigators were not attempting to conduct a scientific experiment or maintain experimental integrity, they did not necessarily adhere to the interview sheet exactly. A blank interview sheet is provided in *Appendix H. Table 3.1* below summarizes points of contacts interviewed, or attempted to be interviewed, in each state. Points of contact were determined from staff listings provided on state stormwater program websites.

**Table 3.1  
Interview Contact List**

<b>State</b>	<b>Contact</b>	<b>Department</b>	<b>Telephone Number</b>	<b>Status of Interview</b>
VT	Padraic Monks – Program Manager	Department of Environmental Conservation, Water Quality Division, Stormwater Section	802-241-1453	Interview conducted
NY	Dave Gasper	Department of Environmental Conservation	518-402-8111	Interview conducted
NM	Richard Powell – Team Leader	New Mexico Environment Department, Surface Water Quality Bureau	505-827-2798	Interview conducted
AK	William Ashton - Storm Water and Wetlands Manager	Department of Environmental Conservation, Division of Water		Point of contact could not be reached
AZ	Chris Henninger – Stormwater Technical Issues- Construction, MS4	Department of Environmental Quality	602-771-4508	Interview conducted
ID	Johnna Sandow – Water Quality Standards Specialist	Department of Environmental Quality, Water Quality Division	208-373-0163	Interview conducted
OR	Dennis Jurries      Jenine Camilleri	Department of Environmental Quality, Water Quality	503-229-937 503-229-6775	Interview conducted Interview conducted
NV	Steve McGoff	Division of Environmental Protection, Bureau of Water Pollution Control	775-687-9429	Interview conducted
NH	Jeff Andrews – Sanitary Engineer III	Department of Environmental Services	603-271-2984	Interview conducted
MA	Fred Civian	Massachusetts Department of Environmental Protection	617-292-5821	Interview conducted
WI	Jim Bertolocini – Stormwater Specialist	Department of Natural Resources	608-264-8971	Voicemail response only
ME	David Ladd	Department of Environmental Protection, Bureau of Land and Water Quality	207-287-5404	Interview conducted
WA	Ed O'Brien	Department of Ecology, Water Quality	360-407-6438	Interview conducted
WV	Sherry Wilkins	Department of Environmental Protection	304-926-0499 x1048	Interview conducted
MD	Jesse Salter – Environmental Program Manager I	Department of the Environment, Compliance Program	410-537-3570	Interview conducted
VA	Doug Fritz – MS4 Program Manager	Department of Conservation and Recreation	804-371-7330	Interview conducted
CA	John Short	Environmental Protection Agency, State Water Resources Control Board, Region 1 (North Coast)	707-576-2065	Point of contact could not be reached
FL	Eric Livingston	Department of Environmental	850-245-8430	Point of

State	Contact	Department	Telephone Number	Status of Interview
		Protection		contact could not be reached
MN	Dale Thompson	Pollution Control Agency	651-757-2776	Point of contact could not be reached
OK	Karen Milford	Department of Environmental Quality, Water Quality Division	405-702-8100	Point of contact could not be reached
PA	Barry Newman	Department of Environmental Protection	717-772-5661	Point of contact could not be reached
RI	Eric Beck	Department of Environmental Management- Water Resources	401-222-4700 x7202	Point of contact could not be reached

### 3.1.4 Findings and Analysis of Permits

*Section 3.1.5* provides detailed state summaries of information collected from each of the 22 subject states. A general summary of data obtained is provided below.

Thirteen of the 22 subject states have LID guidance documents, which may include, but are not limited to narrative standards, prescriptive design standards, and performance standards. The following states have a LID guidance documents:

- Alaska
- California
- Idaho
- Maine
- Massachusetts
- Minnesota
- New Hampshire
- New York
- Pennsylvania
- Rhode Island
- Vermont
- Washington
- West Virginia

LID was typically referenced in GPs, regulations, or policy. The following bulleted list identifies states which have incorporated LID into their stormwater program through one of these three mechanisms, or additional mechanisms.

- California – GP encourages LID
- Maine – Regulation strongly encourages LID
- Massachusetts – LID incorporated into stormwater policy
- Minnesota – Extensive guidance; LID incorporated into pollution prevention
- New York – GP cites the state's stormwater manual, which references LID
- Rhode Island – GP cites LID
- Vermont – Towns require LID; LID encouraged in individual stormwater permits
- Washington – GPs cite LID
- West Virginia – GP cites performance standard

As suggested in the above bulleted list, some states encourage LID, but do not require it as part of their stormwater programs. Alternatively, some states encourage LID while local governments within the state either require LID or encourage LID through incentives and guidance documents. This was specifically noted for Arizona and Oklahoma. Twelve of the 20 subject states encourage LID, but do not require it to be used. The following list identifies states which encourage LID:

- Alaska
- Arizona
- California
- Idaho
- Maine
- Minnesota
- New Hampshire
- New York
- Oklahoma
- Pennsylvania
- Vermont
- West Virginia

It should be noted that West Virginia encourages LID in its construction activity GP, but LID is required of MS4s.

Typical performance standards used in state stormwater guidance documents, regulations, and general permits include:

- Runoff Volume (e.g., water quality volume (WQV) – 1", 0.5", 25%)
- Pollution reduction linked to volume (e.g., 80% total suspended solids (TSS) removal, turbidity, nutrients, sensitive sites)
- Performance Standards (e.g., Area set-aside for LID, imperviousness reduction)

Most states do not give LID primacy (i.e., first preference) over end-of-pipe controls such as detention ponds and sand filters. However, where LID is given primacy, standards used may include:

- Runoff volume (e.g., percentage or fraction of WQV)
- Performance standard (e.g., area set-aside for LID and imperviousness reduction)

### 3.1.5 Summary of Findings by State

This section provides a summary of information collected from each of the 22 subject states. In general, state-by-state summaries are structured as follows:

- Tabular summary of specific standards found in general permits
- Discussion of each general permit identified and reviewed
- Discussion of specific performance standards focusing in particular on LID standards
- Reference documents (generally, these are web-available documents)

#### 3.1.5.1 Alaska

**Table 3.2  
Specific Standards Found in Alaska General Permits**

<b>Key Items</b>	<b>Standards</b>
Runoff volume as an environmental indicator	Not Found
Volume control in relation to pollutant control	Not Found
Permit limits related to storm size and runoff volume	Not Found
Performance criteria	Not Found
LID	Not Found
Pollution prevention	Not Found
End of pipe	Not Found

##### 3.1.5.1.1 General

The Alaska Department of Environmental Conservation (ADEC) Division of Water is responsible for administering the State’s stormwater management program. The ADEC implements three GPs, those permits being for construction activity, industrial activity, and small MS4s. Both the GP for industrial activity and for small MS4s closely follow the National Pollutant Discharge Elimination System (NPDES) Program GPs. Those GPs do not implement LID concepts. Similarly, while ADEC has its own GP for construction activity, it does not include LID techniques.

### 3.1.5.1.2 General Permits

#### 1. **Construction GP**

- *Alaska Pollutant Discharge Elimination System General Permit for Discharges from Large and Small Construction Activities* (Permit Number AKR10000 – effective January 31, 2010)

As stated on the ADEC Division of Water website for the Construction General Permit:

In July 2008, EPA issued its 2008 Construction General Permit and then extended the term of the 2008 CGP by one year. Now the 2008 CGP is a three-year permit, which will expire on or before June 30, 2011. As of October 31, 2009, the Alaska Department of Environmental Conservation (ADEC) is now the storm water permitting authority in Alaska. On January 31, 2010, ADEC reissued the Alaska CGP which is now in effect.

If your project disturbs less than one acre and is not part of the planned disturbance of a larger common plan of development or sale, no permit is required. Otherwise, you must develop and follow a stormwater pollution prevention plan (SWPPP) to manage materials, equipment, and runoff from your construction site.

#### 2. **Small MS4 GP**

As stated on the ADEC website for MS4s:

Regulated small MS4s are defined as all small MS4s located in "urbanized areas" (UAs) as defined by the Bureau of the Census, and those small MS4s located outside of a UA that are designated by NPDES permitting authorities.

In Alaska, the Bureau of the Census recognizes only Anchorage and Fairbanks as urbanized areas.

All operators of regulated MS4s are required to:

- Obtain a NPDES permit.
- Develop a stormwater management program designed to prevent harmful pollutants from being washed by stormwater runoff into the MS4 (or from being dumped directly into the MS4), then discharged from the MS4 into local waterbodies.

Stormwater management program should meet the standard of reducing pollutants to the maximum extent practicable (MEP), and include measures to:

- Identify major outfalls and pollutant loadings.
- Detect and eliminate non-stormwater discharges to the system.
- Reduce pollutants in runoff from industrial, commercial, and residential areas.
- Control stormwater discharges from new development and redevelopment areas.

### 3. Multi-Sector GP

- *Alaska Pollutant Discharge Elimination System General Permit Multi-Sector General Permit for Storm Water Discharges (MSGP)* (Permit Number AKR050000 – effective February 26, 2009)

ADEC implements the multi sector general permit (ADEC MSGP), and as previously mentioned, the ADEC utilizes the NDPES MSGP for regulating industrial activities.

#### 3.1.5.1.3 Performance Criteria

- *Alaska Stormwater Guide (June 2009)*

As stated on the ADEC website for the *Alaska Stormwater Guide*:

ADEC, with the assistance of a work group and a contractor, developed the *Alaska Stormwater Guide* (hereinafter, the “Guide”). Local governments use the guide to set storm water requirements for new development and redevelopment projects. Land developers and development engineers use the guide to help design site plans and determine storm water infrastructure. Businesses and contractors use the guide to help design their storm water pollution prevention plans. The Guide is useful for anyone needing guidance on erosion and sediment control for construction areas.

Furthermore:

The Guide is intended to be flexible, easily updated and responsive to the needs of the Alaska storm water community. The concepts presented in this Guide are intended to be guidance for readers rather than stringent rules. The Guide embraces the concept that each storm water problem is different, so solutions will need to be customized to address this variability (Page i).

Section 3.3.5 of the Guide addresses “Low Impact Development/Environmental Site Design.” Page 3-21 of the Guide states:

LID is new to Alaska, and local communities are still determining which concepts are acceptable or applicable and when they could serve as alternatives to more conventional permanent storm water management controls. The LID concepts that have the highest potential in Alaska are the following:

- Retaining existing or native vegetation
- Reducing directly connected imperviousness
- Reducing curb and gutter and using vegetated swales
- Allowing on-site infiltration for high infiltration areas
- Optimizing development to cluster structures
- Preserve high-quality land or highly sensitive land



It should be noted that the *Alaska Stormwater Guide* is not referenced in the ADEC GPs and is therefore strictly a guidance document.

#### 3.1.5.1.4 References

Alaska Department of Environmental Conservation Division of Water. Wastewater Discharge Authorization-Storm Water. <http://dec.alaska.gov/water/wnpspc/stormwater/index.htm> (Accessed May 10, 2010).

Alaska Department of Environmental Conservation Division of Water. June 2009. *Alaska Stormwater Guide- Chapter 3 Storm Water Design Considerations and Methods*. [http://dec.alaska.gov/water/wnpspc/stormwater/docs/AKSWGGuide\\_Chapter3.pdf](http://dec.alaska.gov/water/wnpspc/stormwater/docs/AKSWGGuide_Chapter3.pdf)

#### 3.1.5.2 Arizona

**Table 3.3  
Specific Standards Found in Arizona General Permits**

Key Items	Standards
Runoff volume as an environmental indicator	Not Found
Volume control in relation to pollutant control	Not Found
Permit limits related to storm size and runoff volume	Not Found
Performance criteria	Not Found
LID	Not Found
Pollution prevention	Not Found
End of pipe	Not Found

##### 3.1.5.2.1 General

The Arizona Department of Environmental Quality (ADEQ) is responsible for administering the State's stormwater management program. As stated on ADEQ's website:

Under the Arizona Pollutant Discharge Elimination System (AZPDES) Permit Program, all facilities that discharge pollutants from any point source into waters of the United States (navigable waters) are required to obtain or seek coverage under an AZPDES permit.

LID is not currently incorporated into any of the GPs. Per a telephone interview with the stormwater and general permits unit manager, ADEQ is waiting for EPA to make changes to the NDPES program before any changes are made by Arizona.

It should be noted that guidance on stormwater BMPs and soil erosion control does not exist at the state level. These guidance documents are developed at the local level, by some

municipalities. Per the telephone interview, some municipalities have incentive programs for LID.

### 3.1.5.2.2 General Permits

#### 1. **Construction GP**

- *Arizona Pollutant Discharge Elimination System General Permit for Discharge from Construction Activity to Water of the United States (AZPDES Construction GP) – Permit No. AZG2008-01, effective February 29, 2008.*

This GP covers stormwater discharges from construction activities in Arizona, except for those construction discharges in Native American land.

#### 2. **Small MS4 GP**

- *Arizona Pollutant Discharge Elimination System General Permit for Discharge from Small Municipal Separate Storm Sewer Systems (MS4s) to Water of the United States (AZPDES Small MS4 GP) – Permit No. AZG2002-02, effective December 19, 2002.*

As stated on Page 9, Part V.A of the AZPDES Small MS4 GP:

Under this GP, MS4s shall develop, implement, and enforce a stormwater management plan (SWMP) designed to reduce the discharge of pollutants from a small MS4 to the maximum extent practicable to protect water quality.

The SWMP must incorporate each of the six minimum control measures.

#### 3. **Multi-Sector GP**

- The Multi-Sector General Permit for Stormwater Discharges Associated with Industrial Activity (2000 MSGP) – Expired on October 30, 2005.

The ADEQ MSGP is designed for discharges of stormwater from certain industrial sites that are of a non-construction nature.

As stated in a draft fact sheet for the ADEQ MSGP:

EPA issued the MSGP 2000 for a five-year term commencing on October 30, 2000 (65 FR 64746). EPA subsequently corrected the MSGP 2000 on January 9, 2001 (66 FR 1675-1678) and March 23, 2001 (66 FR 16233-16237). ADEQ has had authority for implementation, compliance and enforcement of EPA's MSGP 2000 since assuming responsibility for the NPDES permitting program. The MSGP 2000 expired on October 30, 2005 but was administratively continued for facilities that were covered under the permit at the time it expired. EPA's 2008 MSGP, which does not apply in Arizona, became effective on September 29, 2008.

Arizona currently implements the expired MSGP 2000. All facilities in Arizona subject to the permit will need to apply for coverage under ADEQ's new MSGP, which is currently in draft form.

### 3.1.5.2.3 References

Arizona Department of Environmental Quality. Stormwater Permits  
<http://www.azdeq.gov/environ/water/permits/stormwater.html#phase> (Accessed April 22, 2010)

### 3.1.5.3 California

**Table 3.4  
 Specific Standards Found in California General Permits**

<b>Key Items</b>	<b>Standards</b>
Runoff volume as an environmental indicator	Runoff volume is used as a proxy, but not always explicitly.
Volume control in relation to pollutant control	Technology standard requires sizing for the 5-year, 24-hour storm, 85th percentile 24-hour storm, etc.
Permit limits related to storm size and runoff volume	Construction general permit establishes pH and turbidity standards, which may be achieved by meeting technology standards.
Performance criteria:	Best available technology standard is established for application of all management practices.
LID	Strongly encouraged, but not required in most cases. San Francisco requires LID treatment for 100% of the water quality volume.
Pollution prevention	Allows use of pollution prevention to meet permit requirements.
End of pipe	

#### 3.1.5.3.1 General

The California State Water Resources Control Board (SWRCB) is responsible for administering the state's stormwater management program. The SWRCB oversees nine Regional Water Resources Control Boards (RWQCB) that develop stormwater requirements for their jurisdictional areas. Municipalities and counties must comply with the requirements established by their RWQCB.

California's regulatory structure is fairly complex. At the state level, all construction sites disturbing more than one acre, many industrial sites, and all designated MS4s are required to obtain and meet the requirements of NPDES permit coverage. In addition to state, regional, and local regulations, there are a number of established and proposed total maximum daily load (TMDL) requirements and special programs impacting California's watersheds.

In 2005 the SWRCB adopted sustainability as a core value to be included as part of all future policies, activities, guidelines and regulatory actions. LID has been designated as a sustainable stormwater approach and the SWRCB has advanced LID through general permits, training programs, 319 grants, transportation projects, partnerships, etc. LID techniques are now strongly encouraged (effectively required) by incorporation into all new MS4 permits statewide. The SWRCB has provided a wide array of resources to help the RWQCBs and MS4s to develop their LID programs. Regulatory and technical assistance and guidance is funded by the SWRCB and provided through the Central Coast Water Board and LID Center. California has one of the most progressive state LID programs in the nation.

### **Role of RWQCBs**

The RWQCBs ensure general permit compliance. As appropriate, they review reports, require modification to SWMPs and other submissions, impose region-specific monitoring requirements, conduct inspections, take enforcement actions against violators of the general permit, and make additional designations of regulated small MS4s pursuant to the general permit. They may also issue individual permits to regulate small MS4s, and alternative general permits to categories of regulated small MS4s. Upon issuance of such permits by an RWQCB, the general permit shall no longer regulate the affected Small MS4s.

LID is strongly encouraged in the general permit, but it is up to the nine RWQCB to approve the LID scope and approach within each local MS4 program. Each RWQCB has a slightly different approach and emphasis as appropriate to meet local hydrology, geology, and receiving water goals. Therefore, the use of LID within each MS4 program will differ in its selection and emphasis of LID techniques and design strategies. This can best be seen by reviewing the LID design manuals for LA County and San Diego County. Other local governments such as San Mateo County / City have advanced LID through the development of unique advanced LID programs for sustainable green streets providing useful tools for redevelopment of the urban infrastructure.

### **3.1.5.3.2 General Permits**

#### **1. Construction GP (Order NO. 2009 – 0009 – DWQ - Effective July 1, 2010)**

This GP is primarily for erosion and sediment control during construction phase of the project. It requires development of SWPPP that not only address erosion and sediment controls, but must also address the post construction BMP's to be used. The permit strongly suggests the use of LID for the SWPPP and lists some LID techniques that should be used. The permit contains numeric effluent limitations for pH (6.0 to 9.0 pH Units) and turbidity (500 NTU daily average). These limits are presumed to be met using best available technology (BAT) or best conventional pollutant control technology (CBT). The design storm used for the treatment technologies is 5-year 24-hour event. Further, if a TMDL exists, the discharger may be required by a RWQCB order to implement additional BMPs, conduct additional monitoring activities, and/or comply with an applicable waste load allocation and implementation schedule for pH or turbidity.

## 2. MS4 General (SWRCB)

Post construction long term controls promote the use of LID and include the language “Post-construction programs are most efficient when they stress (i) low impact design; (ii) source controls; and (iii) treatment controls.” The general permit also allows for the use of structural and/or non-structural BMPs. The SWRCB establishes the general stormwater management goals and requires them for development of the local stormwater management programs. It is up to each permittee to develop a program that details how it will comply with the general permit including adopting a design guidance.

## 3. Small MS4 GP/ Order (RWQCB)

Each regional board has or is developing MS4 general permit or order for their respective local jurisdictions that specifically sets out the requirements for developing local stormwater management programs. For example, the San Francisco RWQCB has developed a Municipal Regional Stormwater Permit / Order that mandates water quality goals to be “accomplished primarily through the implementation of LID techniques.” Further, the permit specifies that LID must be used for 100% of the water quality volume treatment. The San Francisco municipal permit is quite specific about the allowable types of LID practices and certain design standards. Water quality control places a preference on volume control using technology-based standards based on MEP to protect water quality. The general permit requires regulated small MS4 to develop a stormwater program that describes the BMPs, measurable, implementation time tables to meet the six minimum control measures including control of construction and long term post construction activities.

### 3.1.5.3.3 Performance Criteria

Performance criteria are technology based in order to meet water quality goals. Post-construction treatment control BMPs must incorporate either a volumetric or flow-based treatment control design standard, or both, to mitigate (infiltrate, filter or treat) stormwater runoff. Volumetric measures use the 85<sup>th</sup> percentile 24-hour event to determine the volume to be controlled or treated. The formula to compute this volume is recommended in Urban Runoff Quality Management, WEF Manual of Practice No. 23/ ASCE Manual of Practice No. 87, (1998) or the volume of annual runoff based on unit basin storage water quality volume, to achieve 80 percent or more volume treatment by the method recommended in California Stormwater Best Management Practices Handbook – Industrial/ Commercial, (2003); or the volume of runoff produced from a historical-record based reference 24-hour rainfall criterion for “treatment” that achieves approximately the same reduction in pollutant loads achieved by the 85<sup>th</sup> percentile 24-hour runoff event.

Flow Based Treatment Control BMP – The SWRCB also allows for optional flow control to meet their water quality goals. The standard is to control flow from a rain event equal to at least two times the 85<sup>th</sup> percentile hourly rainfall intensity for the area

or the flow of runoff produced from a rain event that will result in treatment of the same portion of runoff as treated using volumetric standards above.

#### 3.1.5.3.4 References

California LID Policy Review:

[http://www.waterboards.ca.gov/water\\_issues/programs/low\\_impact\\_development/index.shtml](http://www.waterboards.ca.gov/water_issues/programs/low_impact_development/index.shtml)

LID Policy Review:

[http://www.waterboards.ca.gov/water\\_issues/programs/low\\_impact\\_development/docs/ca\\_lid\\_policy\\_review.pdf](http://www.waterboards.ca.gov/water_issues/programs/low_impact_development/docs/ca_lid_policy_review.pdf)

Technical and Regulatory Guidance:

[http://www.swrcb.ca.gov/rwqcb3/water\\_issues/programs/stormwater/low\\_impact.shtml](http://www.swrcb.ca.gov/rwqcb3/water_issues/programs/stormwater/low_impact.shtml)

County of Los Angeles LID Manual:

[http://dpw.lacounty.gov/wmd/LA\\_County\\_LID\\_Manual.pdf](http://dpw.lacounty.gov/wmd/LA_County_LID_Manual.pdf)

County of San Diego LID Manual:

<http://www.sdcountry.ca.gov/dplu/docs/LID-Handbook.pdf>

San Mateo Sustainable Green Streets:

[http://www.flowstobay.org/ms\\_sustainable\\_guidebook.php](http://www.flowstobay.org/ms_sustainable_guidebook.php)

SWRCB General Permit for Construction (Effective July 1 2010):

[http://www.waterboards.ca.gov/water\\_issues/programs/stormwater/docs/constpermits/wqo\\_2009\\_0009\\_complete.pdf](http://www.waterboards.ca.gov/water_issues/programs/stormwater/docs/constpermits/wqo_2009_0009_complete.pdf)

SWRCB Small MS4 General Permit:

[http://www.swrcb.ca.gov/water\\_issues/programs/stormwater/docs/final\\_ms4\\_permit.pdf](http://www.swrcb.ca.gov/water_issues/programs/stormwater/docs/final_ms4_permit.pdf)

San Francisco MS4 Regional Permit:

[http://www.swrcb.ca.gov/sanfranciscobay/board\\_decisions/adopted\\_orders/2009/R2-2009-0074.pdf](http://www.swrcb.ca.gov/sanfranciscobay/board_decisions/adopted_orders/2009/R2-2009-0074.pdf)

### 3.1.5.4 Florida

**Table 3.5  
Specific Standards Found in Florida General Permits**

<b>Key Items</b>	<b>Standards</b>
Runoff volume as an environmental indicator	None found
Volume control in relation to pollutant control	None found
Permit limits related to storm size and runoff volume	None found
Performance criteria	Sediment removal only
LID	None found
Pollution prevention	None found
End of pipe	None found

#### 3.1.5.4.1 General

Under the Florida Water Resources Act of 1972, the Florida Department of Environmental Protection (FLDEP) was given responsibility for administering the state's stormwater management program. FLDEP subsequently delegated authority to the five regional water management districts (WMDs) to regulate stormwater discharges. Under the Environmental Reorganization Act of 1993 stormwater quality and stormwater quantity were combined into the Environmental Resource Permitting Program (ERP) under Part IV of Chapter 373, Florida Statutes. The FLDEP and WMDs share implementation of this program depending upon the type of activity that is permitted.

Regulations for water quality and quantity have been adopted largely to address the specific needs particular to the geographic and hydrologic conditions found in each WMD's jurisdiction. The WMDs have exercised their independent authority for establishing rules (Florida Administrative Code or F.A.C.). In addition to state rules, each WMD and FLDEP have adopted either a design manual or handbook that describes the various BMPs and criteria for addressing water quality and quantity issues. Florida's stormwater rules apply almost exclusively to new development, while redevelopment and retrofit projects are largely permitted on a case-by-case basis. Proposed projects must meet the criteria specified in state law to obtain necessary permits.

Florida has been very slow to embrace LID principles and practices and relies for the most part on more conventional end-of-pipe practices (e.g., ponds) for new construction and temporary construction. A few local governments, Water Management Districts, Universities and environmental groups are providing some leadership to promote LID with guidance information and demonstration projects. Some local governments do on a case-by-case basis work with developers to implement LID projects. However, LID has not been adopted on a statewide basis nor is it promoted by FLDEP.



### 3.1.5.4.2 General Permits

#### 1. **Construction GP**

This permit addresses only with the construction phase of the project and requires typical BMPs to protect water quality. The permit conditions can be found in the state code. LID is not discussed in the permit.

#### 2. **Small MS4 GP**

This permit requires MS4s to develop stormwater management programs that meet EPA six minimum requirements. Guidance on compliance requires consistency with applicable state environmental resource protection requirements and EPA guidance. The MS4 code and generic permit are provided below. LID is not discussed directly in the permit.

### 3.1.5.4.3 Performance Criteria

Overall stormwater management, presumptive criteria, and BMPs are dictated by individual WMD's Environmental Resource Permit. Generally, BMP standards apply to erosion and sediment control. Erosion and sediment are to be retained onsite during construction. No discharge shall violate the state's water quality standard for turbidity. The stormwater treatment performance standard requires removal of at least 80% of the average annual pollutant load for stormwater discharges to Class III (recreational) waters. A 95% removal level was set for stormwater discharges to sensitive waters such as potable supply waters (Class I), shellfish harvesting waters (Class II), and Outstanding Florida Waters (OFWs). In addition, the WMDs have established performance standards to minimize flooding by limiting the post-development stormwater peak discharge rate and, in some cases such as closed basins, the stormwater volume. Design storm frequencies, as well as return intervals are specified by the WMDs.

### 3.1.5.4.4 References

St. John's River Water Management District LID brochure:

[http://www.sjrwm.com/publications/pdfs/fs\\_lowimpactdevelopment.pdf](http://www.sjrwm.com/publications/pdfs/fs_lowimpactdevelopment.pdf)

University of Florida Barriers to LID:

<http://waterinstitute.ufl.edu/research/downloads/Clark-LID.pdf>

Paper on Incentive for LID in Florida:

<http://waterinstitute.ufl.edu/research/downloads/Clark-LID.pdf>

Generic Construction Code:

<http://www.dep.state.fl.us/legal/Rules/shared/62-621.pdf>

Generic MS4 Code:

<http://www.dep.state.fl.us/legal/rules/shared/62-624.pdf>



Generic General MS4 Permit:

[http://www.dep.state.fl.us/water/stormwater/npdes/docs/Phase\\_II\\_MS4\\_GP.pdf](http://www.dep.state.fl.us/water/stormwater/npdes/docs/Phase_II_MS4_GP.pdf)

### 3.1.5.5 Idaho

**Table 3.6  
Specific Standards Found in Idaho General Permits**

Key Items	Standards
Runoff volume as an environmental indicator	Not Found
Volume control in relation to pollutant control	Not Found
Permit limits related to storm size and runoff volume	Not Found
Performance criteria	Not Found
LID	Not Found
Pollution prevention	Not Found
End of pipe	Not Found

#### 3.1.5.5.1 General

EPA is the NPDES permitting authority for Idaho and as such is responsible for issuing NPDES stormwater permits. LID is not currently incorporated into the NPDES General Permits GPs. Notwithstanding, the EPA indicates their promotion of LID on Page 1 of the “NPDES General Permit for Stormwater Discharges from Construction Activities Fact Sheet”:

Stormwater control measures should be designed in accordance with any requirements established by the appropriate local, state, or tribal authority. EPA also strongly encourages operators to use low impact development or green infrastructure practices that promote infiltration and reduce stormwater volumes after development. Additional information on green infrastructure practices can be found at [www.epa.gov/npdes/greeninfrastructure](http://www.epa.gov/npdes/greeninfrastructure).

The Idaho Department of Environmental Quality (Idaho DEQ) stormwater webpage indicates:

The Idaho Department of Environmental Quality (DEQ) provides technical assistance and support for controlling stormwater in Idaho. DEQ's [Catalog of Stormwater Best Management Practices](#) includes site design techniques for controlling stormwater runoff associated with land development activities. DEQ also provides plan and specification review for facilities that control, treat, or dispose of stormwater if requested by the developer or design engineer.

#### 3.1.5.5.2 Performance Criteria

Idaho DEQ has developed guidance documents pertaining to stormwater. Idaho’s primary document is the *Catalog of Stormwater BMPs for Idaho Cities and Counties*. As noted on the DEQ website, this guidance document was recently updated.

The following has been adopted from the Idaho DEQ website for stormwater regarding the updated guidance document.

This document is a revision of the originally *Catalog of Stormwater BMPs for Idaho Cities and Counties* developed in 1998. Its target audience is design professionals, such as landscape architects, geologists, engineers, and soil scientists, and local public officials and staff responsible for the review and approval of development applications.

The revised catalog provides numerous ways to control erosion and sediment during and after construction. It is comprised of the following five volumes:

- Volume 1 – includes a brief discussion of stormwater runoff impacts, an overview of agencies responsible for stormwater permitting and authority in Idaho, and a step-by-step procedure for site design.
- Volume 2 – contains construction BMPs to control erosion and sediment.
- Volume 3 – covers low-impact development and provides techniques that can minimize changes to the hydrology of development sites.
- Volume 4 – contains post-construction/permanent BMPs.
- Volume 5 – provides source control BMPs for industrial, commercial, and residential land use activities.

As described in the bulleted list above, Volume 3 pertains to LID. This volume includes discussion of many LID BMPs, including but not limited to: protect natural site functions, minimize directly connected impervious areas, narrow roadways, and bioretention. A full list of BMPs is provided in the table of contents for volume three. A web link for the document is provided at the end of this summary in the references section. Volume 3 relies heavily on narrative standards to introduce LID techniques. While design standards are discussed for selective BMPs, these are not enforceable, but rather recommended guidelines for implementing the particular LID technique.

### 3.1.5.5.3 References

Idaho Department of Environmental Quality. Stormwater in Idaho: Overview.  
[http://www.deq.idaho.gov/water/prog\\_issues/storm\\_water/overview.cfm](http://www.deq.idaho.gov/water/prog_issues/storm_water/overview.cfm) (Accessed May 10, 2010).

Idaho Department of Environmental Quality. Stormwater: Catalog of Stormwater BMPs for Idaho Cities and Counties.  
[http://www.deq.state.id.us/water/data\\_reports/storm\\_water/catalog/index.cfm](http://www.deq.state.id.us/water/data_reports/storm_water/catalog/index.cfm) (Accessed May 10, 2010).

### 3.1.5.6 *Maine*

**Table 3.7  
Specific Standards Found in Maine General Permits**

<b>Key Items</b>	<b>Standards</b>
Runoff volume as an environmental indicator	Not found
Volume control in relation to pollutant control	Not found
Permit limits related to storm size and runoff volume	Not found
Performance criteria	Not found
LID	Not found
Pollution prevention	Not found
End of pipe	Not found

Maine’s general permits do not directly establish runoff volume standards or performance criteria; however, Maine does establish specific stormwater requirements under its Stormwater Code Chapter 500. This code requires permitting under Maine Revised Statutes Annotated (MRSA) title 38, chapter 3, section 420-D, which states:

A person may not construct, or cause to be constructed, a project that includes one acre or more of disturbed area without prior approval from the department. A person proposing a project shall apply to the department for a permit using an application provided by the department and may not begin construction until approval is received. This section applies to a project or any portion of a project that is located within an organized area of this State.

Standards under Stormwater Code Chapter 500 include volumetric standards and performance criteria for LID, pollution prevention and other BMPs.

#### 3.1.5.6.1 *General*

The Maine Department of Environmental Protection (Maine DEP) is responsible for administering the state’s stormwater management program. Maine’s program establishes permitting requirements for construction sites disturbing more than one acre, industrial sites, and MS4s. The state’s program is governed by Stormwater Code Chapter 500. The code establishes the narrative standards and technology / BMP based controls for new development and redevelopment. There are several categories of stormwater standards including basic, general, phosphorus, flooding and urban impaired stream. More than one standard may apply to a project depending on site conditions and location.

LID is highly encouraged by Maine DEP and mentioned in the state law and the MS4 permits. Technical guidance for LID is provided in their BMP design manual (Volume I, chapter 3) and further detailed in a separate LID design manual. To determine when BMPs are required, Maine DEP uses total area disturbed (1 to 5 acres) and impervious thresholds (2000 square feet to 20,000 square feet) that vary depending on the watershed, receiving water goals and applicable TMDL’s.

### 3.1.5.6.2 General permits

#### 1. **Construction GP**

The permit provides guidance on erosion and sediment control requirements for construction activities. State code and the design manuals provide the narrative anti-degradation specifications, thresholds (1 acre) and guidance on appropriate BMPs for erosion and sediment control. Further, if a stormwater permit is required the construction permit cannot be approved until the stormwater permit is approved. This ensures that LID techniques are considered in the development of the sediment and erosion control plan provide they are part of the post construction BMPs.

#### 2. **Small MS4 GP**

The permit establishes the current State stormwater law governs all projects requiring a permit for pre- and post-construction, and redevelopment activities. The MS4 permit requires that regulated communities implement EPA's six minimum standards. Under these standards the permittee is required to develop a comprehensive stormwater program that includes managing construction permits and post-construction program. The permit suggests the MS4 operator "should also consider the adoption and implementation of low impact development techniques through an ordinance or other regulatory mechanism".

### 3.1.5.6.3 Performance Criteria

State Stormwater Code Chapter 500 establishes many of the stormwater standards that apply to projects disturbing one acre or more, or to a modification of any size. Thresholds of total area and impervious area vary depending on location, impaired waters and type of development. Maine DEP has some latitude to determine which standards should apply and the appropriate mix BMPs. The standards include the following categories:

- **Basic standards** – In general a project disturbing one acre or more must provide appropriate BMPs for construction activities such as erosion and sedimentation control, inspection and maintenance, and housekeeping, respectively.
- **General standards** – General standards project requiring long-term post-construction BMPs. This includes new development and some redevelopment projects. Conventional BMPs are allowed and volume controls are provided for ponds and infiltration devices. The volume controlled equals to 1.0 inches over the area of impervious area, plus 0.4 inches over areas of landscaping. LID BMPs are highly encouraged and specific guidance is provided in the design manuals. As per this note in the State law:

*NOTE: The department strongly encourages applicants to incorporate low-impact development (LID) measures where practicable. LID addresses avoidance of stormwater impacts by*

*minimizing developed and impervious areas on the project site. LID project design considers the location of any protected natural resources, and maintaining natural drainage patterns and pre-construction time of concentration. If practicable, LID incorporates runoff storage dispersed uniformly.*

- Phosphorus standards – The phosphorus standards apply only in lake watersheds. A project disturbing one acre or more and resulting in any of the following is required to meet the phosphorus standards. Permittees must follow specific design guidance is provided in the design manual for determining a lakes phosphorus budget and load reduction allocation for the site.
- Urban impaired stream standard – If required, the urban impaired stream standard applies in addition to the basic standards, general standards and phosphorus standards.
- Flooding standard – If required, the flooding standard applies in addition to the basic standards, general standards, phosphorus standards and urban impaired stream standards. Stormwater management systems for these projects must detain, retain, or result in the infiltration of stormwater from 24-hour storms of the 2-year, 10-year, and 25-year frequencies such that the peak flows of stormwater from the project site do not exceed the peak flows of stormwater prior to undertaking the project.
- Easements and covenants – If projects require off-site areas for the control, disposal, or treatment of stormwater runoff, then these areas must be protected from alteration through easements or covenants.

#### 3.1.5.6.4 References

Stormwater Code Chapter 500:

<http://www.maine.gov/dep/blwq/rules/stormwater/2006/ch500.pdf>

LID Guidance, Vol. I Chapter 3, BMP Manual:

<http://www.maine.gov/dep/blwq/docstand/stormwater/stormwaterbmps/vol1/chapter3.pdf>

LID Guidance Manual for Maine Communities, 2007:

[http://www.maine.gov/dep/blwq/docwatershed/materials/LID\\_guidance/manual.pdf](http://www.maine.gov/dep/blwq/docwatershed/materials/LID_guidance/manual.pdf)

Construction General Permit:

<http://www.maine.gov/dep/blwq/docstand/stormwater/2006mcgptext.pdf>

Small MS4 General Permit:

[http://www.maine.gov/dep/blwq/docstand/stormwater/ms4/final\\_2008\\_ms4\\_gp.pdf](http://www.maine.gov/dep/blwq/docstand/stormwater/ms4/final_2008_ms4_gp.pdf)

MRSA Title 38, Section 420-D:

<http://www.mainelegislature.org/legis/statutes/38/title38sec420-D.htm>

### 3.1.5.7 Massachusetts

**Table 3.8  
Specific Standards Found in Massachusetts General Permits**

Key Items	Standards
Runoff volume as an environmental indicator	None found
Volume control in relation to pollutant control	None found
Permit limits related to storm size and runoff volume	None found
Performance criteria	None found
LID	None found
Pollution prevention	None found
End of pipe	None found

Although LID is not explicitly discussed in the stormwater general permits used by Massachusetts, LID, pollution prevention, runoff volume as an environmental indicator, etc. are incorporated into state regulations and guidance. Thus many of these standards are in effect required.

#### 3.1.5.7.1 General

EPA is the NPDES permitting authority for Massachusetts and as such is responsible for issuing NPDES stormwater permits. LID is not currently incorporated into the NPDES GPs. Notwithstanding, the EPA indicates their promotion of LID on Page 1 of a NPDES General Permit for Stormwater Discharges From Construction Activities Fact Sheet:

Stormwater control measures should be designed in accordance with any requirements established by the appropriate local, state, or tribal authority. EPA also strongly encourages operators to use low impact development or green infrastructure practices that promote infiltration and reduce stormwater volumes after development. Additional information on green infrastructure practices can be found at [www.epa.gov/npdes/greeninfrastructure](http://www.epa.gov/npdes/greeninfrastructure)

Massachusetts is not currently delegated by EPA to issue NPDES permits, but the Massachusetts Department of Environmental Protection (MassDEP) is initiating the process to develop a stormwater management program in accordance with NPDES and the Clean Water Act. As stated on the MassDEP website for regulations and standards:

MassDEP has proposed new regulations implementing a stormwater management program in Massachusetts in accordance with state and federal clean water laws. The proposed 314 CMR 21.00 would confer on MassDEP the authority to issue individual and general surface water discharge permits.

According to the *Amendments to the Wetland Protection Act Regulations and 401 Water Quality Certification Regulations* document provided on the MassDEP website:

In 1996, the Massachusetts MassDEP issued the “Stormwater Policy” that established Stormwater management standards aimed at encouraging recharge and preventing stormwater discharges from causing or contributing to the pollution of the surface waters and ground waters of the Commonwealth. MassDEP also issued the *Massachusetts Stormwater Handbook* that included detailed information on how to apply the Stormwater Management Standards.

Since that time, MassDEP has applied the Stormwater Management Standards pursuant to its authority under the Wetlands Protection Act, M.G.L.c. 131, §40, and the Wetlands Protection Act Regulations, 310, CMR 10.00, when reviewing projects subject to jurisdiction under the Act. MassDEP also applied the *Stormwater Management Regulations* when reviewing projects that require a water quality certification pursuant to 314 CMR 9.00. MassDEP has incorporated the Stormwater Management Standards into both 310 CMR 10.00 and 314 CMR 9.00, thereby eliminating the need for the Stormwater Policy.

#### 3.1.5.7.2 Performance Criteria

The *Massachusetts Erosion and Sediment Control Guidelines for Urban and Suburban areas: A Guide for Planners, Designers, and Municipal Officials*, reprinted in May 2003, does not include implementation of LID techniques. However, the *Massachusetts Stormwater Handbook* incorporates the use of LID throughout the manual. LID techniques do not take primacy of end-of-pipe technologies, at the state level; however, local jurisdictions may require LID in lieu of end-of-pipe stormwater solutions. Determination of LID versus end-of-pipe technologies is determined through the local regulatory processes.

The table presented at the beginning of this summary details performance standards provided in the Massachusetts Stormwater Manual.

#### 3.1.5.7.3 References

Massachusetts Stormwater Handbook:

<http://www.mass.gov/dep/water/laws/policies.htm#storm>

Massachusetts Department of Environmental Protection. Standards and Regulations.

<http://www.mass.gov/dep/water/laws/regulati.htm> (Accessed May 18, 2010).



### 3.1.5.8 Minnesota

**Table 3.9  
Specific Standards Found in Minnesota General Permits**

<b>Key Items</b>	<b>Standards</b>
Runoff volume as an environmental indicator	0.5-inch WQV. 1.0 inch WQV is required in sensitive areas.
Volume control in relation to pollutant control	WQV is intended as a proxy for 80% TSS removal
Permit limits related to storm size and runoff volume	Not found
Performance criteria	80% TSS removal
LID	Not found
Pollution prevention	Section F of the Construction General Permit makes specific pollution prevention requirements
End of pipe	Not found

#### 3.1.5.8.1 General

The Minnesota Pollution Control Agency (MPCA) is responsible for administering the state's stormwater management program. The program relies on a technology base standards where BMPs are designed to meet and MEP standard. Permittees are allowed flexibility to choose appropriate BMPs to meet local conditions and receiving-water requirements. However, for impaired waters, the state and local authorities reserve the right to impose numeric standards if necessary. For example, Minneapolis/St Paul stormwater program has watershed specific phosphorus removal requirements typically ranging from 20-42% removal of total phosphorus.

#### 3.1.5.8.2 General Permits

##### 1. **Construction GP**

The permit only covers construction activities up to site stabilization. A SWPPP is required that incorporates the specific construction BMPs and describes the post-construction long-term BMPs applicable to their site. Post-construction stormwater controls may require a separate permit. Permits are required construction related activity disturbing one acre or more of land. In some cases, smaller sites may require permit coverage if they are part of a larger common plan for development. The permit places a preference on the use of infiltration practices for construction and post construction BMPs but provides numerous options of varying site conditions. MPCA provides design manuals and other design resources for BMP design.



## 2. Small MS4 GP

MS4s are required permittees to develop stormwater pollution prevention plan SWPPP or comprehensive stormwater management plan that must include EPA's six minimum measures including construction and post construction programs to reduce impact to the MEP. The permit allows MPCA to establish stricter requires under certain conditions to ensure water quality standards are met, e.g. TMDL's and impaired waters. The SWPPP must include a mix of structural and nonstructural measures.

Extensive and comprehensive guidance is provided by MPCA to assist and guide MS4 in the development of all aspects of their programs. Included in the guidance is a comprehensive BMP design manual and LID program resources including: ordinances, design manuals and specifications. MPCA has one of the most comprehensive set design resources available. Since the selection of BMPs is up to the judgment of the MS4 the state has provided a thorough list of BMP options for both construction and post-construction controls.

### 3.1.5.8.3 Performance Criteria

MPCA uses a water quality volume of 0.5 inches for the design of construction and post construction retention, detention and infiltration BMPs. Filtration BMPs should achieve 80% TSS removal on an annual basis.

### 3.1.5.8.4 References

General Construction Permit:

<http://www.pca.state.mn.us/water/stormwater/stormwater-c.html#spermit>

MS4 general Permit:

<http://www.pca.state.mn.us/publications/wq-strm4-51.pdf>

Low impact Design Resources:

<http://www.pca.state.mn.us/water/stormwater/stormwater-lid.html>

Minnesota Design Manual and other BMP Resources:

<http://www.pca.state.mn.us/water/stormwater/stormwater-manual.html>

### 3.1.5.9 Nevada

**Table 3.10  
Specific Standards Found in Nevada General Permits**

Key Items	Standards
Runoff volume as an environmental indicator	None found
Volume control in relation to pollutant control	None found
Permit limits related to storm size and runoff volume	None found
Performance criteria	None found
LID	None found
Pollution prevention	None found
End of pipe	None found

#### 3.1.5.9.1 General

The Nevada Division of Environmental Protection (NDEP) is responsible for administering the state’s stormwater management program. Like many states, NDEP implements GPs pertaining to construction activity, industrial activity, and MS4s. LID is not currently incorporated into the GPs.

Stormwater design manuals and LID implementation manuals are developed through local permitting programs. However, as discussed in the sections below, NDEP has developed a Best Management Practice Field Guide to be used as recommendations for stormwater control practices.

As noted during a telephone interview with the NDEP stormwater coordinator, it is difficult to implement LID within the state due to lack of precipitation. BMP controls such as rain gardens and green roofs are, therefore, not necessarily practical given precipitation history. Notwithstanding, the state is looking to implement other aspects of LID. The State works closely with local permittees and encourages LID wherever possible.

#### 3.1.5.9.2 General Permits

##### 1. **Construction GP**

- *Stormwater General Permit NV/R100000* – effective September 16, 2007

According to NDEP’s website pertaining to stormwater discharge permits:

NDEP requires owner/operators to obtain a Construction Stormwater Permit if the project will disturb more than one (1) acres, or will disturb less than one (1) acre but is part of a larger common plan for development or sale that will ultimately disturb one (1) or more acres. If the construction site will disturb less than five (5) acres and meets

certain criteria, the site may be eligible for a construction stormwater permit waiver.

If NDEP determines that a project less than one (1) acre in size will impact receiving waters or its tributaries within a 1/4-mile radius of the project, the owner/operator of the project will also be required to obtain a construction stormwater permit.

## 2. **Small MS4 GP**

- *National Pollutant Discharge Elimination System General Permit for Discharges from Small Municipal Separate Storm Sewer Systems (Small MS4 GP)* – Permit No. NVS040000, expired in December 2007.

This GP originally expired in December 2007, but has been extended to remain in effect until reissuance. Coverage obtained under the existing permits will continue under the reissued permits.

## 3. **Multi Sector GP**

- *General Permit for Stormwater Discharges Associated with Industrial Activity to Waters of the United States* – Permit No. NVR05000, effective September 22, 2008.

This GP is modeled closely after the Environmental Protection Agency (EPA) multi-sector GP and applies to 11 industrial facility categories. Operators having an industrial classification code falling within any of these 11 categories must obtain coverage under the GP.

### 3.1.5.9.3 Performance Criteria

- *Nevada Contractors Field Guide for Construction Site Best Management Practices (BMP Field Guide)* – June 2008

The BMP Field Guide is focused on the appropriate installation of soil erosion and sediment controls. However, this document does reference some common LID practices.

According to the NDEP website:

The Nevada BMP Guide is the result of funding provided by the Nevada Division of Environmental Protection (NDEP), the Truckee Meadows Storm Water Coordinating Committee (TMSWPCC), the Washoe County Regional Water Planning Commission, and the Clark County Regional Flood Control District.

The technical review and development process involved representatives from: the NDEP, the TMSWPCC, the Las Vegas Valley Stormwater Quality Management Committee, the Associated General Contractors of America, the Builders Association of Northern Nevada and other interested members of the public.

The Preface on Page i of the BMP Field Guide indicates:

The regional policies and procedures presented in the Nevada BMP Field Guide are recommendations unless adopted by ordinance or code by the local entity. If the language in this field guide and the adopted ordinance differ, the ordinance language shall take precedence.

Chapter 1, Preconstruction Planning, includes discussion of minimizing impervious surfaces and including LID practices as part of preconstruction planning. This section provides narrative standards for keeping the amount of directly connected roof area, driveways, roads, and parking lots to a minimum.

The Nevada BMP Field Guide also provides narrative description to promote infiltration in project design in Chapter 1, on page 4. A short narrative discussion on disconnecting impervious surfaces is also provided in Chapter 1 on pages 85 and 86.

#### 3.1.5.9.4 Additional Information

- Draft Individual MS4 Permit for Trucking Mills (Permit No. NVS000001)

This draft individual permit only authorizes the City of Reno, the City of Sparks and Washoe County (i.e., Truckee Meadows) to discharge municipal stormwater runoff to the Truckee River, its tributaries, and other waters of the United States in accordance with the conditions and requirements of the GP.

Item IV.F.3.a.ii on page 9 of the draft permit, regarding Post-Construction Stormwater Management Program For New Development and Significant Redevelopment Projects, requires permittees to “Describe how the Permittees will promote the use of low-impact development (“LID”) measures that will remain in effect after construction is complete and are effective and appropriate for the Truckee Meadows and its environment”.

- *The Truckee Meadows Regional Stormwater Quality Management Program Low Impact Development Handbook (LID Handbook)* dated August 2007.

This handbook was created for the Truckee Meadows region. As stated in Section 1.0 on Page 1 of the LID Handbook:

The purpose of the Truckee Meadows Low Impact Development Handbook (the LID Handbook) is to provide regional planning policies, procedures and general guidance on site design techniques for improving the quality and reducing the quantity of storm water runoff from new development and significant redevelopment, to predevelopment conditions, to the Maximum Extent Practicable (MEP). The LID Handbook has primarily been developed to assist planners, developers, architects, landscape professionals, city and county community development and public works staff, and others with the selection and design of features and practices that mimic natural hydrologic functions. As described in this document, LID Handbook should be the first guidance document referenced during the development planning process.

### 3.1.5.9.5 References

City of Reno, Nevada. Regional Stormwater Quality Management Program. <http://www.reno.gov/index.aspx?page=366> (Accessed April 27, 2010)

Kennedy/Jenks Consultants. *The Truckee Meadows Regional Stormwater Quality Management Program Low Impact Development Handbook*. August 2007. <http://www.reno.gov/index.aspx?page=366>

Kennedy/Jenks Consultants. *Nevada Contractors Field Guide for Construction Site Best Management Practices* (June 2008). <http://ndep.nv.gov/bwqp/bmp05.htm>

State of Nevada Division of Environmental Protection Bureau of Water Pollution Control. Stormwater Discharge Permits. <http://ndep.nv.gov/BWPC/storm01.htm> (Accessed April 27, 2010)

### 3.1.5.11 New Mexico

**Table 3.11  
Specific Standards Found in New Mexico General Permits**

<b>Key Items</b>	<b>Standards</b>
Runoff volume as an environmental indicator	Not Found
Volume control in relation to pollutant control	Not Found
Permit limits related to storm size and runoff volume	Not Found
Performance criteria	Not Found
LID	Not Found
Pollution prevention	Not Found
End of pipe	Not Found

#### 3.1.5.11.1 General

EPA is the NPDES permitting authority for New Mexico and as such is responsible for issuing NPDES stormwater permits. LID is not currently incorporated into the NPDES GPs. Notwithstanding the EPA indicates their promotion of LID on Page 1 of a NPDES General Permit for Stormwater Discharges From Construction Activities Fact Sheet:

Stormwater control measures should be designed in accordance with any requirements established by the appropriate local, state, or tribal authority. EPA also strongly encourages operators to use low impact development or green infrastructure practices that promote infiltration and reduce stormwater volumes after development. Additional information on green infrastructure practices can be found at [www.epa.gov/npdes/greeninfrastructure](http://www.epa.gov/npdes/greeninfrastructure).

The New Mexico Environment Department Surface Water Quality Bureau (New Mexico SWQB) assists EPA in regulation of stormwater discharges by performing inspections on behalf of EPA and by serving as a local point of contact for providing information to operators and other agencies regarding this federal regulatory program.

### 3.1.5.11.2 Performance Criteria

It does not appear that New Mexico offers technical guidance on LID at the state level, or any other stormwater BMPs. Rather, New Mexico SWQB directs permittees and interested parties to other resources for implementation of BMPs. Sources include:

- EPA’s National Menu of Best Management Practices
- International Stormwater BMP Database
- Measurable Goals Guidance for Phase II Small MS4s
- Stormwater Center
- Stormwater Authority
- Construction Industry Compliance Assistance Center

### 3.1.5.11.3 References

New Mexico Environment Department Surface Water Quality Bureau. The NPDES Stormwater Program. <http://www.nmenv.state.nm.us/swqb/StormWater/index.html> (Accessed April 27, 2010).

## 3.1.5.12 New Hampshire

**Table 3.12  
Specific Standards Found in New Hampshire General Permits**

<b>Key Items</b>	<b>Standards</b>
Runoff volume as an environmental indicator	Not Found
Volume control in relation to pollutant control	Not Found
Permit limits related to storm size and runoff volume	Not Found
Performance criteria	Not Found
LID	Not Found
Pollution prevention	Not Found
End of pipe	Not allowed under the Alteration of Terrain permit (see below)

### 3.1.5.12.1 General

EPA is the NPDES permitting authority for New Hampshire and as such is responsible for issuing NPDES stormwater permits. LID is not currently incorporated into NPDES GPs.

Notwithstanding, the EPA indicates their promotion of LID on Page 1 of a NPDES General Permit for Stormwater Discharges From Construction Activities Fact Sheet:

Stormwater control measures should be designed in accordance with any requirements established by the appropriate local, state, or tribal authority. EPA also strongly encourages operators to use low impact development or green infrastructure practices that promote infiltration and reduce stormwater volumes after development. Additional information on green infrastructure practices can be found at:

[www.epa.gov/npdes/greeninfrastructure](http://www.epa.gov/npdes/greeninfrastructure)

### 3.1.5.12.2 Alteration of Terrain (AoT) Permit

New Hampshire implements an alteration of terrain (AoT) GP. As stated on the New Hampshire Department of Environmental Services (NHDES) website:

New Hampshire Alteration of Terrain permits are issued by the DES Alteration of Terrain (AoT) Program. This permit protects New Hampshire surface waters, drinking water supplies and groundwater by controlling soil erosion and managing stormwater runoff from developed areas. An AoT permit is required whenever a project proposes to disturb more than 100,000 square feet of contiguous terrain (50,000 square feet, if any portion of the project is within the protected shoreland), or disturbs an area having a grade of 25 percent or greater within 50 feet of any surface water. In addition to these larger disturbances, the AoT Permit by Rule applies to smaller sites.

This permitting program applies to earth moving operations, such as industrial, commercial, and residential developments as well as sand pits, gravel pits, and rock quarries. Permits are issued by DES after a technical review of the application, which includes the project plans and supporting documents.

Per telephone interview with Jeff Andrews as the NHDES, hard piping management techniques cannot be used under the AoT permitting regulations.

### 3.1.5.12.3 Performance Criteria

- *New Hampshire Stormwater Manual*, December 2008

According to the NHDES website:

The New Hampshire Stormwater Manual was developed as a planning and design tool for the communities, developers, designers and members of regulatory boards, commissions, and agencies involved in stormwater programs in New Hampshire.

The manual is intended to be a "living" document and will be updated as new information becomes available. The revision number of the most recent version is included on the title page and the footer on each left-hand page.

The manual is presented in three volumes and is currently in the process of being updated. Below is a summary of LID related topics covered in the New Hampshire Stormwater Manual.

- Volume 1, Chapter 6 – Non Structural Site Design Techniques
  - Minimize disturbed areas
  - Maintain natural buffers
  - Disconnect impervious cover
  - Minimize soil compaction
  - Alternative pavement
  - Impervious surface disconnection methods
- Volume 2, Chapter 4, Section 4.1 – LID “Interception Practices)

#### 3.1.5.12.4 References

New Hampshire Department of Environmental Services. Alteration of Terrain Program. <http://des.nh.gov/organization/divisions/water/aot/> (Accessed May 6, 2010).

New Hampshire Department of Environmental Services. Stormwater. <http://des.nh.gov/organization/divisions/water/stormwater/index.htm> (Accessed May 6, 2010).

#### 3.1.5.13 New York

**Table 3.13  
Specific Standards Found in New York General Permits**

<b>Key Items</b>	<b>Standards</b>
Runoff volume as an environmental indicator	Reference to <i>New York State Stormwater Management Design Manual</i>
Volume control in relation to pollutant control	
Permit limits related to storm size and runoff volume	
Performance criteria	Reference to <i>New York State Stormwater Management Design Manual</i>
LID	
Pollution prevention	
End of pipe	

##### 3.1.5.13.1 General

The New York State Department of Environmental Conservation (NYDEC) is responsible for administering the state’s stormwater management program.



### 3.1.5.13.2 General Permits

#### 1. **Construction GP**

- *New York State Department of Environmental Conservation SPDES General Permit for Stormwater Discharges from Construction Activity* (NYDEC Construction GP) – Permit No. GP-O-IO-00I, effective January 29, 2010.

This GP addresses construction activity and post-construction BMPs. Under the GP, a permittee is required to develop a SWPPP. The SWPPP must meet requirements to address soil erosion and sediment control practices as well as post-construction practices.

LID is not directly addressed within this GP. However, the GP does reference the *New York State Stormwater Management Design Manual* (Design Manual), which addresses the use of LID techniques. References to the Design Manual occur in the following sections of the NYDEC Construction GP:

- Part III.B.2
- Part III.B.3
- Appendix C

#### 2. Small MS4 GP

- *New York State Department of Environmental Conservation SPDES General Permit for Stormwater Discharges from Small Municipal Separate Storm Sewer Systems* (NYDEC Small MS4 GP) – Permit No. GP-0-08-002, effective May 1, 2008

Under the NYDEC Small MS4 GP, permittees must develop, implement, and enforce a SWMP designed to reduce the discharge of pollutants from small MS4s to the MEP. Six minimum control measures must be met in development of the SWMP. Further, New York State separates MS4's into three categories, those being traditional land use control MS4s, traditional non-land-use control MS4s, and nontraditional MS4s. Six minimum control measures for each of the three categories are described in the GP.

Use of LID is referenced within this GP under minimum control measure five for each aforementioned category. As stated in Part VII.A.5.a.iv on page 33 and in Part VIII.A.5.a.iv on page 51 of the NYDEC MS4 GP, the stormwater program shall include:

A combination of structural management practices (including, but not limited to practices from the NYS Stormwater Management Design Manual or equivalent) and / or non-structural management practices (including, but not limited to comprehensive plans, open space preservation programs, *LID*, Better Site Design (BSD) and other *Green Infrastructure* practices, land use regulations) appropriate for the *permittee* that will reduce the *discharge* of pollutants to the MEP.

It should also be noted that in the same aforementioned sections of the Small MS4 GP:

Permittees are encouraged to implement *Green Infrastructure* practices at a site level and to review, and revise where appropriate, local codes and laws that include provisions that preclude construction that minimizes or reduces pollutant loadings.  
(page 33)

### 3. **Multi Sector GP**

- *SPDES Multi-Sector General Permit for Stormwater Discharges Associated with Industrial Activity* – Permit No. GP-0-06-002, effective March 28, 2007.

LID is not directly addressed within this GP. However, the GP does reference the Design Manual, which addresses the use of LID techniques. Part 2 on Page VIII.L-1 states:

A comprehensive SWPPP addressing the storm water run-on and run-off control systems needed during the landfill's construction, operation and closure phases must be prepared prior to the commencement of any construction activity that will result in a land disturbance of one or more acres of land. The plan must be prepared in accordance with the New York Standards and Specifications for Erosion and Sediment Control, dated August 2005; and the New York State Stormwater Management Design Manual.

Sector L, Part 6 on Page VIII.L-4 also states:

The design, construction and maintenance of all post-construction stormwater management controls shall conform to the New York State Stormwater Management Design Manual.

#### 3.1.5.13.3 Performance Criteria

*New York State Stormwater Management Design Manual (Prepared August 2003, Updated April 2008)*

As adopted from the NYDEC website:

The current New York State Stormwater Management Design Manual provides designers with a general overview on how to size, design, select, and locate stormwater management practices at a development site to comply with State stormwater performance standards. This manual is a key component of the Phase II State Pollution Discharge Elimination System (SPDES) general permit for stormwater runoff from construction activities from all sizes of disturbance.

NYDEC is in the process of updating the Design Manual, and the draft is currently under public review. The draft Design Manual now has chapters specifically dedicated to green infrastructure and stormwater management planning. The following list summarizes topics discussed in each chapter. Standards within the Design Manual are summarized in the above table.

- Chapter 5 – Green Infrastructure Practices
  - 5.1 Preservation of Natural Features and Conservation Design – Narrative Standards
  - 5.2 Reduction of Impervious Cover – Narrative and prescriptive design standards
  - 5.3 Green Infrastructure Techniques
    - Runoff reduction by area
    - Runoff reduction by volume (The practices in this section may be combined with runoff reduction by area and standard water quality practices to achieve distributed runoff control)

### 3.1.5.13.4 References

State of New York Department of Environmental Conservation. Stormwater. <http://www.dec.ny.gov/chemical/8468.html> (Accessed April 27, 2010)

Center for Watershed Protection. New York State Stormwater Management Design Manual (April 2008). <http://www.dec.ny.gov/chemical/29072.html>

State of New York Department of Environmental Conservation. New York State Stormwater Management Design. Chapter 5. Green Infrastructure. Practices (DRAFT). Manual [http://www.dec.ny.gov/docs/water\\_pdf/greeninfra.pdf](http://www.dec.ny.gov/docs/water_pdf/greeninfra.pdf)

### 3.1.5.14 Oklahoma

**Table 3.14  
Specific Standards Found in Oklahoma General Permits**

Key Items	Standards
Runoff volume as an environmental indicator	Not Found
Volume control in relation to pollutant control	Not Found
Permit limits related to storm size and runoff volume	Not Found
Performance criteria	Not Found
LID	Not Found
Pollution prevention	Not Found
End of pipe	Not Found

#### 3.1.5.14.1 General

The Oklahoma Department of Environmental Quality (Oklahoma DEQ) is responsible for administering the state’s stormwater management program with the exception of Native American lands, which are regulated by EPA Region 6. Oklahoma’s stormwater program is closely modeled after the federal NPDES program minimum standards, which requires stormwater be treated to the MEP. Numeric treatment requirements specific to stormwater

have not been established at the state level, but water quality parameters can be established by local governments and the Water Quality Control Board on a site-by-site basis when the risk of contamination is present.

Oklahoma DEQ's program establishes permitting requirements for construction sites disturbing more than one acre, industrial sites, and MS4s. Each permitted MS4 is responsible for establishing a SWMP either under the Phase I or Phase II of the NPDES stormwater regulations. Additional permitting requirements may be imposed at the county and municipal level.

The regulations do not specifically promote LID but are flexible enough to allow MS4's to adopt LID programs if desired. LID is being promoted at the local level and by various organizations in watershed where surface water protection and restoration is important especially to protect drinking water sources.

#### 3.1.5.14.2 General Permits

##### 1. **Construction GP**

The permit only covers construction activities up to final stabilization of the site. A SWPPP is required with appropriate sediment and erosion controls and that must describe the post construction BMPs to be used. The permit describes the type of post construction BMP allowed including: stormwater detention structures (including wet ponds); stormwater retention structures; flow attenuation by use of open vegetated swales and natural depressions; infiltration of runoff onsite; and sequential systems (that combine several practices). The SWPPP must also include an explanation of the technical basis used to select the practices to control pollution where flows exceed predevelopment levels. Post-construction stormwater BMPs that discharge pollutants from point sources once construction is completed, may need authorization under a separate permit.

##### 2. **Small MS4 GP**

Requires MS4s to develop, implement, and enforce a comprehensive stormwater program that include construction activities that result in a land disturbance of greater than or equal to one acre. MS4s must develop a post construction stormwater program for new development and redevelopment that follows the EPA six minimum standards with the goal of preventing or minimizing water quality impacts. BMPs must include both structural and nonstructural techniques that are appropriate for the MS4's local conditions. The permit allows for the use of several LID techniques including: filtration practices such as grassed swales, bioretention cells, sand filters and filter strips and infiltration practices such as infiltration basins and infiltration trenches.

### 3.1.5.14.3 Performance Criteria

Numeric treatment requirements specific to stormwater have not been established at the state level, but water quality parameters are established on a site-by-site basis when the risk of contamination is present. Narrative standards generally use MEP to protect water quality and the designated receiving water uses and water quality standards established by the Oklahoma Water Quality Board. Specific volume and flow controls are established at the local level with a focus on flood control.

### 3.1.5.14.4 References

OK State University LID Program / Guidance:

<http://lid.okstate.edu/>

American Rivers LID Program for Lower Maumee and Ottawa Rivers:

<http://www.americanrivers.org/assets/pdfs/reports-and-publications/low-impact-development-manual.pdf>

Construction General Permit:

[http://www.deq.state.ok.us/WQDnew/stormwater/construction/okr10\\_final\\_permit\\_2009-09-03.pdf](http://www.deq.state.ok.us/WQDnew/stormwater/construction/okr10_final_permit_2009-09-03.pdf)

Small MS4 General Permit:

[http://www.deq.state.ok.us/WQDnew/stormwater/ms4/phase\\_ii\\_small\\_ms4\\_final\\_permit\\_8\\_feb\\_2005.pdf](http://www.deq.state.ok.us/WQDnew/stormwater/ms4/phase_ii_small_ms4_final_permit_8_feb_2005.pdf)

### 3.1.5.15 Oregon

**Table 3.15  
Specific Standards Found in Oregon General Permits**

<b>Key Items</b>	<b>Standards</b>
Runoff volume as an environmental indicator	Not found
Volume control in relation to pollutant control	Not found
Permit limits related to storm size and runoff volume	Not found
Performance criteria	Not found
LID	Not found
Pollution prevention	Not found
End of pipe	Not found

### 3.1.5.15.1 General

The Oregon Department of Environmental Quality (Oregon DEQ) Water Quality Division is responsible for administering the State's stormwater management program. The Oregon DEQ is currently in the process of updating each of their general permits; those permits being for construction activity, industrial activity, and small MS4s. The GPs, as they currently exist, do not incorporate implementation of LID policy. At least for the renewal of the GP associated with construction activity, LID will not be incorporated into the permit due to the quick timeline proposed for establishing the permit.

### 3.1.5.15.2 General Permits

#### 1. **Construction GP**

- *General Permit National Pollutant Discharge Elimination System Stormwater Discharge Permit* (Permit Number 1200-C, issued December 28, 2005)

As stated on the cover page of this permit, sources covered by the permit include:

Construction activities including clearing, grading, excavation, and stockpiling that will disturb one or more acres and may discharge to surface waters or conveyance systems leading to surface waters of the state. Also included are activities that disturb less than one acre that are part of a common plan of development or sale if the larger common plan of development or sale will ultimately disturb one acre or more and may discharge to surface waters or conveyance systems leading to surface waters of the state.

#### **Small MS4 GP**

Small MS4s are permitted through individual permits. Though individual permit numbers are assigned to each MS4, the contents of the permits remains consistent. As indicated on Page 1 of a fact sheet for Oregon's Phase II Municipal Stormwater Program:

The proposed permits require communities to implement a stormwater management program and to develop measurable goals to evaluate. Individual communities have the flexibility to determine the practices and measurable goals that are most appropriate for their system. The chosen practices and measurable goals, submitted to DEQ as part of the permit application, become the required stormwater management program.

#### 2. **Multi-Sector GP**

As stated on the Oregon DEQ website for NPDES Stormwater Discharge Permits –Industrial Activities:

As part of its efforts to protect and improve Oregon's water quality, DEQ issues stormwater discharge permits to industries that discharge stormwater into rivers, lakes and streams from pipes, outfalls or other point sources at a site. Based on federal

regulations, National Pollutant Discharge Elimination System (NPDES) permit coverage is required for industrial facilities that discharge stormwater from their industrial areas to surface waters of the state, or to storm drains that discharge to surface waters.

Oregon DEQ issues three industrial activity GPs.

- *General Permit National Pollutant Discharge Elimination System Storm Water Discharge Permit* (Permit Number 1200-A, issued December 28, 2005)
- *General Permit National Pollutant Discharge Elimination System Storm Water Discharge Permit* (Permit Number 1200-Z, issued July 1, 2007)
- *General Permit National Pollutant Discharge Elimination System Storm Water Discharge Permit* (Permit Number 1200-COLS, issued September 1, 2006)

### 3.1.5.15.3 Performance Criteria

The GPs reviewed do not discuss performance criteria.

### 3.1.5.15.4 References

Oregon Department of Environmental Quality. Water Quality Permit Program –NPDES Stormwater Discharge Permits <http://www.deq.state.or.us/wq/stormwater/stormwater.htm> (Accessed May 7, 2010).

Oregon Department of Environmental Quality. Water Quality Permit Program –NPDES Stormwater Discharge Permits – Industrial Activities. <http://www.deq.state.or.us/wq/stormwater/industrial.htm> (Accessed May 7, 2010).

State of Oregon Department of Environmental Quality Water Quality Division. Fact Sheet: Oregon’s Phase II Municipal Stormwater Program. Updated November 27, 2006. <http://www.deq.state.or.us/wq/pubs/factsheets/stormwater/ph2munistmprg.pdf> (Accessed May 7, 2010).

### 3.1.5.16 Pennsylvania

**Table 3.16**  
**Specific Standards Found in Pennsylvania General Permits**

<b>Key Items</b>	<b>Standards</b>
Runoff volume as an environmental indicator	Not Found
Volume control in relation to pollutant control	Not Found
Permit limits related to storm size and runoff volume	Not Found
Performance criteria	Not Found
LID	Not Found
Pollution prevention	Not Found
End of pipe	Not Found



### 3.1.5.16.1 General

The Pennsylvania Department of Environmental Protection (PADEP) is responsible for administering the state's stormwater management program. Pennsylvania's stormwater program is closely modeled after the federal NPDES program, which requires stormwater be treated to the MEP. Pennsylvania's NPDES stormwater program establishes permitting requirements for construction sites disturbing more than one acre, industrial sites, and MS4s.

MS4s are responsible for developing comprehensive stormwater management programs that meet the minimum program EPA requirements, Pennsylvania code and general permit. PADEP provides suggested specific guidance for BMP design, volume controls, model ordinances, etc. The guidance includes details on the use of LID principles and practices for the control of new development and provided as reference only. The state design manual is very comprehensive and provides a wide range of BMP options for conventional and LID techniques. In Pennsylvania, most NPDES permits are administered by county conservation districts through delegation agreements with PADEP. Conservation districts process and authorize the permit applications, conduct site inspections, respond to complaints, and in certain circumstances, conduct enforcement actions.

### 3.1.5.16.2 General Permits

#### 1. **Construction GP**

Construction sites greater than 1 acre are required to obtain an approved erosion and sediment control plan. Of particular importance is the requirement for a post construction stormwater management plan that must employ stormwater management BMPs to control the volume, rate, and water quality of the post construction stormwater runoff to protect and maintain the chemical, physical, biological properties and existing/designated uses of the waters the commonwealth.

#### 2. **Small MS4 GP**

Permittees must develop a stormwater management program that meets EPA six minimum requirements. The state uses a technology based standard to meet a MEP standard. The state provides comprehensive programmatic and BMP guidance for permittee to use. The BMP guidance is not part of the requirements but only reference as guidance.

### 3.1.5.16.3 Performance Criteria

Many of the standards are narrative such as: maintain the existing water balance in all watersheds and protect and restore natural hydrologic characteristics. These criteria are established in municipal ordinances, as supported by the watershed stormwater management plan. In general, these stormwater management techniques will ensure that post-development runoff rates throughout the watershed do not exceed pre-development levels.



#### Example Performance Standards Chesterfield County:

Structural and non-structural stormwater management practices that provide, promote or otherwise make best possible use of infiltration on-site shall be considered first and foremost in all site designs.

Water quality management shall be provided through the use of structural and/or non-structural stormwater management practices. Water quality stormwater management practices shall be designed to reduce or eliminate solids, sediment, nutrients, and other potential pollutants from the site.

Stormwater quality management practices shall be designed to capture and treat stormwater runoff generated by the one-inch rainfall event.

Reduce the total impervious cover on the site by at least twenty percent (20%), based on a comparison of existing impervious cover to proposed impervious cover; **or** achieve a ten percent (10%) reduction in the total volume of runoff generated and discharged from the site by a 2-year storm event. Runoff calculations shall be based on a comparison of existing site conditions to post development site conditions; **or** reduce the post development peak discharge rates to ninety percent (90%) of the predevelopment peak discharge rates for the 2-year, 10- year, 25-year, 50-year and 100-year 24-hour storm events based on a comparison of existing ground cover to post development site conditions.

The one (1) inch storm event represents 80% of the total volume of rainfall and 95% of all rainfall events that occur in a typical year.

#### 3.1.5.16.4 References

General Construction Permit fact Sheet:

<http://www.buckinghampa.org/inc/documents/3/Fact-Sheet-NPDES-Permits.pdf>

Draft General Municipal Permit:

[http://www.elibrary.dep.state.pa.us/dsweb/Get/Document-75300/3930-PM-WM0100%20DRAFT\\_PAG13%20for%20posting%20to%20eLibrary.pdf](http://www.elibrary.dep.state.pa.us/dsweb/Get/Document-75300/3930-PM-WM0100%20DRAFT_PAG13%20for%20posting%20to%20eLibrary.pdf)

Stormwater BMP Manual:

<http://www.elibrary.dep.state.pa.us/dsweb/View/Collection-8305>

Chester County Example local model ordinance:

<http://www.stormwaterauthority.org/assets/swmordinance.pdf>

Low Impact Development: The Village at Springbrook Farms Lebanon County PA Case Study:

<http://www.stormwaterpa.org/low-impact-development.htm>

### 3.1.5.17 Rhode Island

**Table 3.17  
Specific Standards Found in Rhode Island General Permits**

Key Items	Standards
Runoff volume as an environmental indicator	Via reference to the Rhode Island Stormwater Manual both water quality volume and peak flows.
Volume control in relation to pollutant control	Via reference to the Rhode Island Stormwater Manual; 80% TSS.
Permit limits related to storm size and runoff volume	
Performance criteria	
LID	Via reference to the Rhode Island Stormwater Manual. The draft Stormwater Manual employs a credit based system.
Pollution prevention	Via reference to the Rhode Island Stormwater Manual
End of pipe	Via reference to the Rhode Island Stormwater Manual

#### 3.1.5.17.1 General

The Rhode Island Department of Environmental Management (RIDEM) is responsible for administering the State’s stormwater management program, the Rhode Island Pollutant Discharge Elimination System (RIDDES). RIDEM implements general permits to enforce RIDDES regulations, including GPs for construction activity, industrial activity, and for small MS4s. Each of the three GPs are described below.

In general, Rhode Island has incorporated LID into their stormwater program via references to LID requirements in the *Rhode Island Stormwater Design and Installation Standards Manual* (Final Draft April 2010) (RI Stormwater Manual), as discussed below. Through the RI Stormwater Manual, Rhode Island requires the use of LID techniques for site design in order to reduce the generation of the water runoff volume for both new and redevelopment projects. *Rhode Island implements the Stormwater Design and Installation Standards Manual as a de facto regulation*, although applicants are technically allowed to propose alternative standards that are “equivalent.” Rhode Island is in the latter stages of adopting revisions to the RI Stormwater Manual, which was originally drafted in 1993. RIDEM will accept permit applications using the 2010 draft of the RI Stormwater Manual. RIDEM intends to promulgate the 2010 revisions.

## 1. **Construction GP**

- *General Permit Rhode Island Pollutant Discharge Elimination System Stormwater Discharge Associated with Construction Activity* (Effective September 26, 2008)

This GP does not directly address LID. However, the GP does reference the RI Stormwater Manual, which does address LID in the final draft (available on line). Section III.A.11 on page 7 indicates that:

Signed certification by a Registered Professional Engineer, a Certified Professional in Erosion and Sediment Control (CPESC), a Certified Professional in Storm Water Quality (CPSWQ), or a Registered Landscape Architect, that the SWPPP has been developed in accordance to the requirements of this permit as well as all applicable guidelines of the *Soil Erosion and Sediment Control Handbook* and the *Storm Water Design and Installation Standards Manual*.

Further discussion of the RI Stormwater Manual is provided at the end of this summary.

## 2. **Small MS4 GP**

- *General Permit Rhode Island Pollutant Discharge Elimination System Storm Water Discharge from Small Municipal Separate Storm Sewer Systems and from Industrial Activity at Eligible Facilities Operated by Regulated Small MS4s* (Permit Number RIR040000, effective November 14, 2003).

Like the Construction GP, the MS4 GP requires LID via document reference to the RI Stormwater Manual (as revised). Permittees are also required to consider and incorporate LID as part of drainage projects. Progress toward meeting this requirement must be reported out on an annual basis. As stated in Section G.1 of the Small MS4 GP, on Page 33, “the operator must submit an annual report for each year after the permit is issued by March 10th. The reports must contain information regarding activities of the previous calendar year.”

Further Section G.2.j on Page 34 indicates the following must be contained in the annual report:

Planned municipal construction projects and opportunities to incorporate water quality BMPs, low impact development as well as activities to promote infiltration and recharge.

Applicants to municipalities are also required to address LID through the MS4 GP. Section IV.B.5.a.3 on Page 19 indicates the post-construction program must include:

Procedures for site plan review to ensure that design of controls to address post-construction runoff are consistent with the State of Rhode Island Stormwater Design and Installation Manual (as amended).

MS4 operators must document the decision process for the development of a post-construction stormwater management program. This involves development of a rationale statement.

Section IV.B.5.b.2, on Page 20, states that the permittee's rationale statement must include:

Description of how the program is consistent with the State of Rhode Island Stormwater Design and Installation Manual (as amended) and how the program will be specifically tailored for the local community or facility, will minimize water quality impacts, and will work to maintain pre-development runoff conditions considering opportunities for groundwater recharge.

### 3. **Multi-Sector GP**

- *Multi-Sector General Permit Rhode Island Pollutant Discharge Elimination System Storm Water Discharge Associated with Industrial Activity (excluding Construction Activity)* (Permit Number RIR500000, effective May 1st, 2006).

#### 3.1.5.17.2 Performance Criteria

- *Rhode Island Stormwater Design and Installation Standards Manual* (Final Draft April 2010).

As stated on the RIDEM website for Stormwater Guidance, "The R.I. design standards for handling and treating stormwater runoff are being updated and revised jointly by the RIDEM and CRMC." Additionally:

The existing 1993 *State of Rhode Island Storm Water Design and Installation Standards Manual*, developed by RIDEM and RICRMC, is in effect until the new manual is officially adopted. Notwithstanding, both agencies have been accepting similar, improved stormwater methods and practices on a case-by-case basis where agency reviewers agreed that greater water quality benefits would result.

The 1993 Stormwater Design and Installation Standards Manual does not reference LID techniques. However the April 2010 Draft RI Stormwater Manual begins to incorporate LID concepts into BMP design.

Chapter 4.0 of the Draft RI Stormwater Manual addresses LID site planning and design strategies. As stated on Page 4-1 of the RI Stormwater Manual:

This chapter presents a suite of LID methods that designers and developers can choose from to treat, infiltrate, and reduce the stormwater runoff at a site. The LID site planning process is required to meet Minimum Standard 1, and an LID Credit is available that helps project applicants meet the recharge and treatment requirements of Minimum Standards 2 and 3.

Section 3.2 of the Draft RI Stormwater Manual addresses the minimum standards referenced above. Standard 1 is LID Site Planning and Design. According to this standard on Page 3-2 of the Draft RI Stormwater Manual:

LID site planning and design strategies must be used to the maximum extent practicable<sup>1</sup> in order to reduce the generation of the water runoff volume for both new and redevelopment projects. All development proposals must include a completed Stormwater Management Plan checklist (Appendix A) and Stormwater Management Plan for review by the approving agency that shows compliance with this standard. If full compliance is not provided, an applicant must document why key steps in the process could not be met and what is proposed as mitigation. The objective of the LID Site Planning and Design Strategies standard is to provide a process by which LID is considered at an early stage in the planning process such that stormwater impacts are prevented rather than mitigated.

### 3.1.5.17.3 References

State of Rhode Island Department of Environmental Management Office of Water Resources. RIPDES Stormwater Program.

<http://www.dem.ri.gov/programs/benviron/water/permits/ripdes/stwater/index.htm>

(Accessed May 10, 2010).

State of Rhode Island Department of Environmental Management Office of Water Resources. Stormwater Guidance.

<http://www.dem.ri.gov/programs/benviron/water/permits/ripdes/stwater/t4guide/desman.htm>

(Accessed May 10, 2010).

### 3.1.5.18 Vermont

**Table 3.18  
Specific Standards Found in Vermont General Permits**

<b>Key Items</b>	<b>Standards</b>
Runoff volume as an environmental indicator	Not found
Volume control in relation to pollutant control	Not found
Permit limits related to storm size and runoff volume	Not found
Performance criteria	
LID	No perform criteria were found; however, LID must be included in municipal policy. Stormwater “credits” are used as a proxy for treatment volume.
Pollution prevention	Not found
End of pipe	Not found

### 3.1.5.18.1 General

The Vermont Department of Environmental Conservation (VDEC) Water Quality Division is responsible for administering the state's stormwater management program. The program includes implementation of individual and GPs as well as utilization of guidance manuals. VDEC implements additional regulations, and requires additional permit coverage, from federal regulations. The following is a list of all general permits carried out under the VDEC stormwater management program. However, this summary only focuses on the construction, multi-sector, and small MS4 GPs.

- New Development and Redevelopment Discharges to Waters that are Not Principally Impaired by Collected Stormwater Runoff
- Previously Permitted Discharges to Waters that are Not Principally Impaired by Collected Stormwater Runoff
- Designated Discharges to Bartlett, Centennial, Englesby, Morehouse, and Potash Brooks

As will be discussed below, only the draft MS4 GP references the use of LID. Notwithstanding, VDEC incorporates LID into some state guidance manuals. While LID does not take primacy over end-of-pipe practices, LID is encouraged. Although not in the regulations, permittees can receive credit in the form of reduced treatment volume requirement for disconnection.

VDEC publishes the following guidance manuals:

*The Vermont Standards and Specifications for Erosion Prevention & Sediment Control, 2006*  
*The Vermont Stormwater Management Manual; Volume I - Stormwater Treatment Standards, 5<sup>th</sup> printing, April 2002.*

The *Vermont Stormwater Management Manual* (VT Stormwater Manual) does contain low impact develop related techniques, as discussed below in this summary.

### 3.1.5.18.2 General Permits

#### 1. **Construction GP**

- *State of Vermont Agency of Natural Resources Department of Environmental Conservation General Permit 3-9020 (2006) for Stormwater Runoff from Construction Sites – effective September 13, 2006.*

The current construction GP does not incorporate LID into State regulations. Notwithstanding, the original version of 3-9020 permit was issued in September 2006. An amended permit was issued in February 2008. The following language has been adopted from the VDEC website pertaining to stormwater permits:

Construction General Permit 3-9020 authorizes permittees to discharge stormwater runoff from construction activities provided the project is in compliance with the requirements of the permit. The permitting requirements for projects authorized under this general permit depend upon the risk of having a discharge of sediment in the stormwater runoff from the construction site. There are two risk categories authorized by the general permit--low risk and moderate risk. Projects that pose a higher risk are ineligible to use the general permit, and must file an application for an individual permit.

Projects that qualify as low risk do so because of favorable site conditions, use of vegetated buffers on water bodies, and the use of prompt stabilization and phased earthwork. For these projects, applicants will need to file a notice of intent that certifies that they will employ the erosion prevention and sediment control measures contained in the *Low Risk Site Handbook for Erosion Prevention and Sediment Control*. A complete application for a low-risk eligible project will be automatically authorized following a 10-day public comment period provided no comments are received.

Projects that are qualify as moderate risk require the development of a site specific Erosion Prevention and Sediment Control (EPSC) Plan that meets the requirements of the general permit and conforms to the *Vermont Standards and Specifications for Erosion Prevention and Sediment Control (2006)*. Moderate risk projects require design by an individual familiar with the principles of erosion prevention and sediment control.

## 2. Multi-Sector GP

- *Vermont Multi-Sector General Permits for Stormwater Discharges Associated with Industrial Activity MSGP 3-9003, NPDES Number – Effective August 18, 2006*

The VDEC MSGP does not incorporate LID into State regulations. The VDEC MSGP is a federally mandated NPDES permit that covers new and existing discharges of stormwater from industrial facilities. Industrial facilities conduct activities and use materials that have the potential to impact the quality of Vermont's waters. The permit requires facilities to examine potential sources of pollution, implement measures to reduce the risk of stormwater contamination, and test stormwater discharges for sources of pollution. Permit coverage is required by private and municipal industries identified on the VDEC MSGP Standard Industrial Classification (SIC) code list.

## 3. Small MS4 GP

- *Draft State of Vermont Agency of Natural Resources Department of Environmental Conservation National Pollutant Discharge Elimination System (NPDES) General Permit 3-9014 (2010) for Stormwater Discharges from Small Municipal Separate Storm Sewer Systems*

In November 1999 the EPA issued new federal stormwater regulations for the census defined metropolitan areas of less than 100,000 people called the Phase II Stormwater Rule. In Vermont eight municipalities with MS4 are required to come into compliance with this rule. VDEC is in the process of reissuing the MS4 Permit to replace the current version. A draft of



the permit was released on January 22, 2010 for public comment and has yet to be finalized as of the writing of this summary document.

The small MS4 GP incorporates LID into its regulations for discharges to impaired waters with an approved TMDL. Section IV.C.1.d.2.d states that “For those MS4s that discharge to stormwater-impaired waters with EPA-approved stormwater TMDLs, the permittee shall comply with the following requirements:

Each MS4 permittee, in consultation with the Agency, shall work cooperatively with any other MS4 permittees that discharge into the same stormwater impaired watershed to develop and submit a single, comprehensive FRP for the stormwater-impaired watershed... The FRP shall contain...a regulatory analysis that identifies and describes what, if any, additional regulatory authorities, including but not limited to the authority to require low impact development BMPs, the permittee will need in order for the permittee to implement the FRP.

(pg 11).

Section IV.C.1.d.7 also states:

Beginning in the second year following issuance of this permit, or designation as a regulated MS4, the permittee shall develop a program to identify opportunities for and provide assistance to landowners in the implementation of LID BMPs such as maximizing disconnection, maximizing infiltration of stormwater runoff, preventing and eliminating soil erosion, and preventing and eliminating the delivery of pollutants to stormwater conveyances.

Additionally, the small MS4 GP incorporates LID into minimum control measures four and five. Section IV.G.4.a.5 states:

In conjunction with the review required by Subpart IV.G.5.b., the permittee shall review existing policies; planning, zoning and subdivision regulations; and ordinances to determine their effectiveness in managing construction-related erosion and sediment and controlling waste such as discarded building materials, concrete truck washout, chemicals, litter, and sanitary waste at construction sites that may cause adverse impacts to water quality. The policies, regulations, and ordinances must also be reviewed for their consistency with the requirements of the Secretary’s general permits for stormwater runoff from large and small construction sites and construction erosion guidelines for low impact development. The permittee may adopt requirements that complement or are more stringent than the requirements of the Secretary (Pg 23).

Section IV.G.5.d states:

For stormwater runoff that discharges into the small MS4 from new development and redevelopment projects that disturb greater than or equal to one acre (including projects less than one acre that are part of a larger common plan of development or sale) and that are not subject to regulation under the Agency’s post-construction stormwater management permit program the permittee must adopt, if it has not already done so, an



ordinance, planning, zoning and subdivision regulation, or other regulatory mechanism, or if the permittee is a nontraditional MS4, a policy that utilizes a combination of structural, non-structural and low impact BMPs, which are appropriate for the community and meet, at a minimum, requirements in the Agency's 2002 Vermont State Stormwater Management Manual (and any amendments thereto); and (Pg 25).

### 3.1.5.18.3 Performance Criteria

- The Vermont Stormwater Management Manual; Volume I - Stormwater Treatment Standards, 5<sup>th</sup> printing. April 2002.

Section 3 of the VT Stormwater Manual discusses voluntary stormwater management credits. As stated in the introduction of the VT Stormwater Manual:

This section provides six groups of nonstructural practices that can be used to gain stormwater credits that will significantly reduce the cost and size of the stormwater treatment practices at a site. The key benefit of these non-structural practices is that they reduce the generation of stormwater runoff at a site, thereby resulting in decreased treatment and storage volumes. These nonstructural practices are completely voluntary and need not be used by a permit applicant.

Stormwater credits can be obtained through the use of the following six groups of non-structural practices:

- Credit 1 – Natural Area Conservation
- Credit 2 – Disconnection of Rooftop Runoff
- Credit 3 – Disconnection of Non-Rooftop Runoff
- Credit 4 – Stream Buffers
- Credit 5 – Grass Channels
- Credit 6 – Environmentally Sensitive Rural Development

Performance standards provided in the VT Stormwater Manual are summarized in the above table.

### 3.1.5.18.4 References

Vermont Department of Environmental Conservation Water Quality Division. Welcome to the Stormwater Section. <http://www.anr.state.vt.us/dec//waterq/stormwater.htm> (Accessed May 6, 2010).

Vermont Agency of Natural Resources. The Vermont Stormwater Management Manual; Volume I - Stormwater Treatment Standards, 5<sup>th</sup> printing. April 2002.  
[http://www.anr.state.vt.us/dec//waterq/stormwater/docs/sw\\_manual-vol1.pdf](http://www.anr.state.vt.us/dec//waterq/stormwater/docs/sw_manual-vol1.pdf)

### 3.1.5.19 Washington

**Table 3.19  
Specific Standards Found in Washington General Permits**

<b>Key Items</b>	<b>Standards</b>
Runoff volume as an environmental indicator	Washington applies a water quality volume and peak runoff standard
Volume control in relation to pollutant control	Pollution control standards for turbidity and pH are assumed to be met if the 12 minimum control measures are met under the Construction GP
Permit limits related to storm size and runoff volume	The peak runoff standard is graduated for the 6-month, 2-, 10-, and 50-year storms
Performance criteria	Not Found
LID	Not Found
Pollution prevention	Required by narrative standard
End of pipe	Not Found

#### 3.1.5.19.1 General

The Washington State Department Ecology (Washington DOE) is responsible for administering the state stormwater management program. Washington DOE establishes permitting requirements for construction sites disturbing more than one acre, industrial sites, and MS4s. Each permitted MS4 is responsible for establishing a SWMP to address construction, development and new development activities. The Phase II MS4 jurisdictions are required to include LID as part of their SWMP. Further, LID specific technical design guidance is provided by the state and other stakeholder organizations such as the Puget Sound Partners.

In 2008 the Washington State Pollution Control Hearings Board order the Department of Ecology that it must require mandatory use of LID for the Phase I communities and to work towards mandatory requirements. The board specifically directed Washington DOE to amend the Phase I permits to 1) require the identification and elimination of barriers to implementing LID, 2) require the identification of LID practices that can be implemented immediately, 3) require the establishment of goals and metrics to “identify, promote, and measure” LID use, including schedules by which Phase II jurisdictions will require such techniques. Washington DOE is currently working with stakeholders to develop LID guidelines and implementation time tables.

To meet water quality goals Washington DOE uses a technology based approach and provides detailed technical BMP design guidance in separate manuals for the Western and Eastern parts of the state. Western and Eastern Washington have different hydrology, geology and receiving water goals. Eastern Washington is a high plains desert climate with half the rainfall as Western

Washington. The Western Washington stormwater program is more applicable to that of Connecticut so only Western Washington examples are provided.

### 3.1.5.19.2 General Permits

#### 1. **Construction GP**

Construction projects greater than five acres must apply for coverage under the General Permit for Construction activities. Other projects must apply to the local government for plan approval and if in the Puget Sound basin are subject to the Puget Sound Water Quality Management Plan goals (PSWQMP) or other requirement for TMDLs. Generally, the PSWQMP requirements are more stringent with lower impervious thresholds for controls. The general permit only covers the construction phase up to final stabilization and does not address post-construction BMPs.

#### 2. **MS4 GPs Phase I and II**

Under a current court order the Phase I MS4 permits will be revised to require mandatory use of LID. Under the current permit for Phase II MS4s LID is required as part of the minimum stormwater program requirements for new development and redevelopment. LID use is also required as part of the educational program for homeowners. Clear guidance on LID BMP's is provided in the Volume III of the Western Washington design manual as well as technical guidance provided by the Puget Sound Partnership.

### 3.1.5.19.3 Performance Criteria

For construction activities water quality action levels standards are: a) Turbidity: shall not exceed 5 NTU turbidity units over background turbidity when the background turbidity is 50 NTU or less, or have more than a 10 percent increase in turbidity when the background turbidity is more than 50 NTU. b) pH: shall be within the range of 6.5 to 8.5 (freshwater) or 7.0 to 8.5 (marine water) with a human-caused variation within a range of less than 0.2 units. For Class A and lower water classifications, the permissible induced increase is 0.5 units. Although there is no specific surface or ground water quality standard for petroleum products, the narrative surface water quality criteria prohibits any visible sheen in a discharge to surface water. It is presumed that if you apply the 12 minimum control elements required in the general construction permit and detailed in the design manual these standards will be met. All of the technical requirements are detailed in Volume I of the stormwater design manual.

For development and redevelopment BMPs in western Washington must be designed to remove 80% of the TSS load during the peak of the 6-month, 24-hour storm. In addition, all stormwater treatment devices must be designed so that peak discharges from the 2-, 10-, and 50-year, 24-hour storm do not exceed predevelopment rates. Additional treatment requirements exist in many of the counties and municipalities in Western Washington for metals, phosphorus bacteria and oil and grease.

BMPs for long-term management of stormwater at developed sites are divided into three main categories (1) BMPs addressing the volume and timing of stormwater flows (2) BMPs addressing prevention of pollution from potential sources; and (3) BMPs addressing treatment of runoff to remove sediment and other pollutants. For the purpose of designing most types of runoff treatment BMPs, a calibrated continuous simulation hydrologic model based on the EPA's HSPF (Hydrologic Simulation Program-Fortran) program, or an approved equivalent model, must be used to calculate runoff and determine the water quality design flow rates and volumes. The flow rate at or below which 91% of the runoff volume, as estimated by an approved continuous runoff model, will be treated. Design criteria for treatment facilities are assigned to achieve the applicable performance goal at the water quality design flow rate (e.g., 80% TSS removal).

### 3.1.5.19.4 References

Puget Sound Partnership:

[http://www.psparchives.com/our\\_work/stormwater/lid.htm](http://www.psparchives.com/our_work/stormwater/lid.htm)

Pollution Control Hearing Board Ruling:

[http://www.earthjustice.org/library/legal\\_docs/phase-ii-final-order.pdf](http://www.earthjustice.org/library/legal_docs/phase-ii-final-order.pdf)

Stormwater Management Manual for Western Washington:

<http://www.ecy.wa.gov/programs/wq/stormwater/manual.html#How to Find the Stormwater Manual on the>

Construction General Stormwater Permit:

<http://www.ecy.wa.gov/programs/wq/stormwater/construction/constructionfinalpermit.pdf>

### 3.1.5.20 West Virginia

**Table 3.20  
Specific Standards Found in West Virginia General Permits**

<b>Key Items</b>	<b>Standards</b>
Runoff volume as an environmental indicator	One-inch of runoff must be managed using LID and pollution prevention
Volume control in relation to pollutant control	Not specified
Permit limits related to storm size and runoff volume	Not specified
Performance criteria	
LID	One-inch of runoff must be managed using LID
Pollution prevention	Narrative standard in the GP
End of pipe	End-of-pipe BMPs may be used once LID and pollution prevention options are exhausted; however, a performance standard is not provided.

### 3.1.5.20.2 General

The West Virginia Department of Environmental Protection (DEP) is responsible for administering the state's NPDES stormwater management program. West Virginia's stormwater program is modeled after the federal NPDES program, which requires stormwater be treated to the MEP. LID is encouraged in the general construction permit as part of the required description of post construction BMPs. LID elements are required in the MS4 permit that includes a variety of watershed site planning/design techniques and onsite BMP controls to address flow, volume and temperature mitigation requirements. Each permitted MS4 is responsible for establishing a SWMP that includes managing construction permits and development of an LID program. Technical guidance provided is generally from EPA sources.

#### 1. **Construction GP**

Disturbance of one acre or more requires an approved SWPPP with appropriate BMPs to meet state water quality standards for construction activities to control erosion and sediment. A groundwater protection plan (GPP) is required to protect source waters. The SWPPP must include a description of the post-construction BMPs. Permittee "should consider," but is not required to use LID for site development and long term post-construction controls.

#### 2. **Small MS4 GP**

Regulated communities must develop stormwater management programs that meet EPA minimum standards (e.g., six minimum control measures). This includes the development of a comprehensive stormwater management program to control flow, volume and temperature of runoff from new and redevelopment sites. The stormwater program minimum requirements are numerous and quite specific including:

- Modification of all policy and plans documents such as master land use plans, zoning, subdivision ordinances to reduce impervious surfaces and increase conservation.
- Utilization of practices to include dry swales, bioretention, rain tanks and cisterns, soil amendments, roof top disconnections, permeable pavement, porous concrete, permeable pavers, reforestation, grass channels, green roofs and other practices that alone or combined to capture the first one inch of rainfall runoff volume.
- Preserve, protect, create and restore ecologically sensitive areas that provide water quality benefits and serve critical watershed functions (including riparian corridors, headwaters, floodplains and wetlands).

Where the water quality goals cannot be met using these techniques alternative measure are allowed including off site mitigation and fee-in-lieu.

### 3.1.5.20.3 Performance Criteria

The MS4 permit requires management measures in combination or alone, keep and manage on site the first one inch of rainfall from a 24-hour storm preceded by 48 hours of no measurable precipitation. Runoff volume reduction can be achieved by canopy interception, soil amendments, evaporation, rainfall harvesting, engineered infiltration, extended filtration and/or evapotranspiration and any combination of the aforementioned practices. This first one inch of rainfall must be 100% managed with no discharge to surface waters, except when the permittee chooses either site mitigation or fee in lieu as an alternatives. Management of the runoff be achieved through on site practices including: dry swales, bioretention, rain tanks and cisterns, soil amendments, roof top disconnections, permeable pavement, porous concrete, permeable pavers, reforestation, grass channels, green roofs and other practices that alone or combined will capture the first one inch of rainfall runoff volume. Extended filtration practices that are designed to capture and retain up to one inch of rainfall may discharge volume in excess of the first inch through an under drain system.

### 3.1.5.20.4 References

EPA LID / Green Infrastructure Guidance:

<http://www.epa.gov/nps/lid/>

WV General Construction Permit 2007:

<http://www.dep.wv.gov/WWE/Programs/stormwater/csw/Documents/2007%20Construction%20Stormwater%20General%20Permit.pdf>

WV General Construction Permit (2010 Modifications):

<http://www.dep.wv.gov/WWE/Programs/stormwater/csw/Documents/WV0115924%20Modification.pdf>

WV MS4 General Permit:

<http://www.dep.wv.gov/WWE/Programs/stormwater/MS4/permits/Documents/WV%20MS4%202009%20General%20Permit.pdf>

### 3.1.5.21 *Wisconsin*

**Table 3.21  
Specific Standards Found in Wisconsin General Permits**

<b>Key Items</b>	<b>Standards</b>
Runoff volume as an environmental indicator	Not Found
Volume control in relation to pollutant control	80% TSS standard
Permit limits related to storm size and runoff volume	Not Found
Performance criteria	Not Found
LID	1 – 2% of the site area must be set aside for infiltration (not specifically a LID standard)
Pollution prevention	Not Found
End of pipe	Not Found

#### 3.1.5.21.1 General

The stormwater program is administered by the Wisconsin Department of Natural Resources (Wisconsin DNR). The requirement, standards and basic design goals for managing construction site and post-construction runoff are described in Wisconsin’s Administrative Code for stormwater management. The program attempts to meet water quality standards through use of technology based standards and provides specific design guidance manual on pre- and post-construction BMPs. Wisconsin DNR does not specifically promote LID, but they embrace many LID principles and techniques such as avoidance of impacts and use heavy reliance on infiltration practices (trenches, bioretention and swales) to protect water quality. Compared to California, Washington or Maine, Wisconsin’s program is fairly conventional.

State Code Chapter NR 151 provides the overarching pollution performance criteria to achieve required water quality standards for construction and post-construction activities. For construction activities, a plan is required for all sites over 1 ac that must use BMPs to achieve appropriate BMP design and sizing guidance is provided in the Wisconsin Erosion and Sediment Control Manual.

#### 3.1.5.21.2 General Permits

##### 1. **Construction GP**

Requirements are described in state code and BMP guidance is provided in the design manual. The design manual is adopted by reference in the code. The code provides a clear update and approval process for modifications to the manual.



## 2. Small MS4 GP

Requirements are described in the state code and BMP guidance is provided in the design manual. The Wisconsin DNR design manual is adopted by reference in the code. The permit identifies communities that are regulated by the MS4 permit and requires them to implement a stormwater program that follows EPA's six minimum requirements, provides for consistency with the state stormwater code and includes a construction site control program.

### 3.1.5.21.3 Performance Criteria

The general performance standard of 80% TSS removal on an average annual basis compared to no controls to protect water quality. The same performance standard is used for post-construction and redevelopment. Further, for post-construction when infiltration is used a volume equal to 90% of the predevelopment infiltration volume must be used. No more than 1% of the site may be used for infiltration purposes for residential sites and 2% for industrial sites. Detailed guidance on BMP sizing to meet the standards is provided in the state design manual.

### 3.1.5.21.4 References

WI Code Chapter NR 216 Storm Water Discharge Permits:

<http://www.legis.state.wi.us/rsb/code/nr/nr216.pdf>

MS4 General Permit:

[http://dnr.wi.gov/runoff/pdf/stormwater/permits/S050075-1%20\\_municipal\\_permit.pdf](http://dnr.wi.gov/runoff/pdf/stormwater/permits/S050075-1%20_municipal_permit.pdf)

Website address to purchase all design manuals:

<http://learningstore.uwex.edu/Wisconsin-Storm-Water-Manual-P603C0.aspx>

---

## 3.2 Partner Recommendations

### 3.2.1 Informing and Engaging Partners

DEP is using a variety of media and methods to engage partners. Partners were initially made aware of the Low Impact Development and Stormwater General Permit Evaluation initiative through a letter and email sent on May 12, 2010. This letter is provided in *Appendix A* of this document. In particular, the letter announces an initiation meeting. Four other meetings are also planned for this project and will be announced through email and a project webpage. We intend to use the May 26 meeting to set the schedule for the four additional meetings.

DEP has established a project webpage, which may be accessed at:

[http://www.ct.gov/dep/cwp/view.asp?a=2719&q=459488&depNav\\_GID=1654](http://www.ct.gov/dep/cwp/view.asp?a=2719&q=459488&depNav_GID=1654)



This webpage is being used to provide important project information, such as:

- Workshop agendas and summaries
- Workshop presentations
- Project reports and other related materials

Beyond the workshops, webpage, and project announcements, DEP intends to engage partners through one-on-one interaction. While this sort of interaction can occur at workshops, individual conversations provide a more personalized opportunity for direct feedback. Therefore, as a starting point to the project, telephone interviews are being conducted for the specific purpose of requesting partner ideas on how to best develop and implement LID policy. The remainder of this report addresses the use and results of these telephone interviews.

### 3.2.2 Telephone Interviews

This section of the report discusses 27 telephone interviews with project partners, which were conducted between May 14, 2010 and July 1, 2010. It details:

- The structure of the interview process
- Interview questionnaire and conversation
- Findings from the interviews

#### 3.2.2.1 Interview Process

Interviews with partners were conducted following the dissemination of an invitation, sent both by post and email on May 12, 2010, requesting that partners attend a project initiation meeting on May 26, 2010 at DEP headquarters at 79 Elm Street in Hartford. In part the letter also stated:

Fuss & O'Neill, contractor for the project, will be contacting you in advance of the May 26 partner workshop to begin the discussion of LID and SGP amendment process. Your ideas will also be used to guide activities at the workshop.

Interviews were initiated through telephone calls placed by Fuss & O'Neill staff. If staff was unsuccessful in directly reaching a partner (i.e., potential interviewee) a message was left. Follow-up calls were made on subsequent days. In some cases, partners also returned calls, in which case interviews were conducted at that time.

Interviews were based on an interview sheet, which is discussed further in *Section 3.2.2.2* below.

#### 3.2.2.2 Interview Questionnaire and Conversation

Investigators used an interview sheet or “questionnaire” to structure our conversations with partners and gather their ideas for incorporating LID into state policy. The purpose of the interview sheet was to help us to collect similar and consistent information from each partner.

The structure also helped to facilitate our conversations with interviewees. As investigators were not attempting to conduct a scientific experiment or maintain experimental integrity, they did not necessarily adhere to the interview sheet exactly. A blank interview questionnaire is provided in *Appendix I*.

The interview sheet includes an introductory statement and a series of questions. The statement makes two key points. It notes:

- DEP's intent to update the four general permits, Stormwater Quality Manual, and Soil Erosion Control Guidelines to include LID.
- DEP's intent to make this initiative partner driven and that DEP is asking partners to define their role in the process.

The interview sheet includes seven questions. Some of the questions are compound. That is to say that they may include more than one actual request for information around a specific thought or idea. *Section 3.2.2.3 Findings* addresses general interview responses to each of the seven questions.

### 3.2.2.3 Findings

To date, Fuss & O'Neill has conducted interviews with 27 partners. Although not all of the 50 plus partners have been interviewed, the 27 interviews conducted to date do provide a representative cross-section of partners including municipalities, trade organizations, federal, regional, and state government, utility companies, and environmental organizations.

This section of the summary follows the structure of questions in the interview form. Specifically, each question from the interview sheet is written in italics text followed by a general discussion of the responses received from interviewees.

#### 3.2.2.3.1 Are you Familiar with LID Practices?

1. *Are you familiar with LID practices? (If not, interviewer should provide some description. Also this is an opportunity to discuss aspects of LID that the interviewee may not be considering)*

This was included as a first question for two primary reasons. First, the question serves to orient interviewees on LID. A number of the questions that follow are relatively complex and require interviewees to express philosophical views about the use of regulations, government intervention, and policy. By contrast, this is a very concrete question and generally generates a “yes” or “no” response.

Secondly, this question reveals a basic level of understanding of the subject matter and gives the interviewee the permission to say “no, I’m not familiar with LID”; or “my organization is interested in this topic, but you should really be speaking to [name of other person].” The interviewer can then gauge the approach to further questioning to facilitate answers from the interviewee and to avoid asking questions of the interviewee that, frankly, he or she may not be prepared to answer.

Most interviewees answered the question in the affirmative (25 of 27); however, three respondents answered “a little” or “yes, somewhat”; and two respondents answered in the negative.

### 3.2.2.3.2 Have you been Involved in the Application of LID?

1. *Have you been involved in their application on a project or in policy?*

The table below provides a basic breakdown of responses to question two.

**Table 3.22**  
**Interviewee Reports of Experience with LID**

<b>Type of LID Experience</b>	<b>Number of Responses</b>	<b>Percentage of Responses</b>
At Least Some Experience	19	70%
Policy or Advocacy Only	6	22%
Project Experience Only	2	7%
Both Project and Policy	11	41%
Neither	5	19%

Like Question 1, Question 2 is fairly concrete and tends to generate straight-forward responses; although Question 2 does allow respondents to provide some description of the type of projects they worked on and how LID has been applied. This was also helpful in preparation for later questions.

### 3.2.2.3.3 How Should LID be Incorporated into DEP Policy?

1. *How do you think they [LID practices] should be incorporated into DEP policy?*
  - a. *By reference to a document*
  - b. *Specific standards*
    - i. *Narrative standard*
    - ii. *Prescriptive design standard*
    - iii. *Numeric standard*
    - iv. *Performance standard*
  - c. *Other methods*

Question 3 represents the first in a series of “open” questions. That is to say that Question 3 is not a question that lends itself to a simple “yes” or “no” response. To encourage open responses the interviewer tended to present the question as follows:

This is a bit more of an open question. How do you think LID should be incorporated into DEP policy? And I’m going to give you a few suggestions here, but you should not feel a need to limit your response:

By reference to a document?

Specific standards? Such as:

- Narrative standards;
- Prescriptive design standards;
- Numeric standards; or
- Performance standard (not that the other standards couldn't be performance standards); or

You could suggest other methods

Table 3.23 (below) provides a summary of responses received. Responses to this question provide no clear consensus on an implementation approach. In fact, many respondents specifically stated that they were unsure, unqualified to answer, or needed to give the matter further consideration.

In reviewing responses as a whole, it is important to consider some apparent—but not generally real—contradictions in terms. For example, some respondents were interested in using combined approaches and specifically suggested the use of flexible, performance-based guidance as well as LID requirements in general permits.

Respondents typically suggested incentive-based approaches in place of regulatory approaches. One respondent stated “[LID] should be a suggestion, not required. Use [of LID] should be incentivized.” Other respondents who suggested use of incentives were less specific about whether or not to regulate. Suggestion to use incentive-based approaches should be viewed as significant as it was not suggested in the interview sheet.

**Table 3.23**  
**Interviewee’s Preference for Type of LID Standard**

<b>Type of LID Standard</b>	<b>Number of Responses<sup>1</sup></b>	<b>Percentage of Responses</b>
Guidance	7	26%
No Regulation	5	19%
Incentive-Based Approach	2	7%
Regulation	6	22%
Performance Standard	7	26%
Not sure or no response	3	11%

Note:

1 Total number of responses do not sum to 17 as several respondents suggested use of a combination of approaches.

### 3.2.2.3.4 Should LID be the BMP of Choice?

1. *Should LID be the BMPs of choice over end-of-pipe management practices such as detention ponds? If so, how?*

Table 3.24 provides an overview of responses. It is important to note that many affirmative responses came with qualification such as “yes, but allow flexibility based on site conditions,” or “yes, but use demonstration projects to encourage [LID] use.” Interestingly, no respondents answered “no” directly. Those respondents who did not answer “yes” or “no” suggested “flexibility” or implementation on a “case-by-case” basis. Generally, respondents appear to favor LID, but may have reservations about using LID as the BMP of choice without consideration of site conditions.

**Table 3.24**  
**Interviewee’s Response to the Question**  
**“Should LID be the BMP of Choice?”**

<b>Should LID be the BMP of Choice?</b>	<b>Number of Responses</b>	<b>Percentage of Responses</b>
Yes no Qualification	4	15%
Yes with Qualification	14	52%
No Response	2	7%
Other Approach Suggested	4	15%
No	0	0%

### 3.2.2.3.5 What Standards Should we use to Demonstrate the use of LID in Projects?

1. *What sort of standards should we use as a way to demonstrate the incorporation of LID?*
  - i. *Runoff volume*
  - ii. *Graduated permit limits for differently sized storms and runoff volumes*
  - iii. *Pollutant levels based on runoff volumes*
  - iv. *Performance criteria*

When asking this question, the interviewer generally stated it conversationally, but essentially verbatim with an addition after “performance criteria” stating “or you can suggest an approach.”

Table 3.25 provides an overview of responses to the question “how should we demonstrate LID?” As can be seen by reviewing the responses, no strong consensus emerges for a method to demonstrate the use of LID on projects, although “runoff volume” and “performance criteria” were the most frequently mentioned. Several respondents made a point of suggesting that regardless of the approach taken, it should be simple and allow for flexibility. Several respondents suggested targeting/graduating implementation to a specific industry (e.g., residential development) or through special requirements for geographic areas.

**Table 3.25**  
**Interviewee’s Response to the Question**  
**“How Should LID be Demonstrated?”**

<b>How Should LID be Demonstrated?</b>	<b>Number of Responses</b>	<b>Percentage of Responses</b>
Runoff Volume	7	26%
Graduated Permit Limits	1	4%
Pollutant Levels Based on Runoff Volume	1	4%
Performance Criteria	5	19%
No Response or Not Sure	6	22%
Suggested “Flexibility” in Response	2	7%
Suggested “Simplicity” in Response	1	4%
Other Approach Suggested	4	15%

### 3.2.2.3.6 Should we use Stormwater Utility Districts as a Regulatory Device?

1. *In some states stormwater utility districts charge a fee for service to oversee BMP design review, installation, operation and maintenance. What do you think of the ideas of using stormwater utility districts as a regulatory device?*
  - a. *Do you see stormwater utility districts playing a role in permitting?*
    - i. *Do you think they could reasonably be delegated regulatory functions?*
    - ii. *Do you think they could reasonably function as qualified local programs? That is programs that are allowed by DEP to implement the Phase II General Permit on behalf of MS4 operators.*
    - iii. *Do you think they could otherwise be used to facilitate compliance?*
  - b. *What advantages do you see available through stormwater utility districts?*

This question presented some challenges for use in the interview. Interviewees had varying levels of familiarity with the concept of stormwater utilities. This may have biased some responses and in at least two interviews led to responses of “unsure” or “no response.” When respondents appeared unfamiliar with stormwater utilities, the interviewer explained their application. Another issue with this question, which may have led to less than clear responses, is the fact that most people, who are familiar with utilities, are familiar with them as revenue generating devices, not regulatory devices. A number of respondents answered the question with a statement such as “I’ve never considered using utility districts in that way.”

Table 3.26 presents a summary of interviewee responses to the idea of using stormwater utility districts as regulatory devices. Virtually all interviewee responses were qualified in some way. This included all the “yes” responses, all but two “maybe” responses, and all but one “no” response. One respondent noted that there was specific interest for implementation of a utility district in that respondent’s region, but that actual implementation was unlikely due to political issues.

**Table 3.26**  
**Interviewee's Response to the Question**  
**"Should we use Stormwater Utility Districts as a Regulatory Device?"**

<b>Should we use Utility Districts as a Regulatory Device?</b>	<b>Number of Responses</b>	<b>Percentage of Responses</b>
Yes	5	19%
Maybe, Not Sure, etc.	5	19%
No	7	26%
Politically Unlikely	6	22%
Unnecessary Government	8	30%

### 3.2.2.3.7 What would you like your Role to be in Implementing LID?

2. *What would you like your role to be in implementing LID as part of the SGP?*
  - a. *Developing and reviewing technical standards*
  - b. *Developing policy*
  - c. *Engaging the involvement of a constituency*
  - d. *Public education*
  - e. *Training*
  - f. *As a qualified local program*
  - g. *Implementation of a stormwater utility district*
  - h. *Other*
  - i. *Are you willing to participate as a partner in this project by attending partner meetings and reviewing work products?*
    - i. *Are you the appropriate contact person for this project?*
    - ii. *Provide contact information*

In order to facilitate responses, this question was asked by grouping role opportunities as follows:

- Technical standards and policy.
- Engaging involvement of a constituency.
- Education and training of other.
- Qualified local programs and utility districts.
- Participation as a partner.

Interviewees generally responded positively to the opportunity to participate and indicated that either they or another representative of their organization would participate as partner and/or other capacities.

Table 3.27 provides a summary of responses.

**Table 3.27**  
**Interviewee's Response to the Question**  
**"What Role would you like to Play?"**

<b>What Role would you like to Play?</b>	<b>Number of Affirmative Responses</b>	<b>Percent of Affirmative Responses</b>
Develop and/or Review Policy and Standards	20	74%
Engage a Constituency	20	74%
Education and Training of Others	22	81%
Qualified Local Program and Utility Districts	11	41%
Participation as a Partner	26	96%

### 3.3 Input from Workshops 1 and 2

On May 26 and July 1, 2010 workshops were conducted with the project partners. In part, the workshops included card storming sessions and a carousel activity. The following sections describe the input received from the workshops and how this information can be used to help identify implementation alternatives.

#### 3.3.1 Workshop 1 and 2 Card Storming

On May 26 and July 1, 2010, workshops were conducted with the project partners, which in part included a card storming session. The session was initiated with the following aims:

- Rational aim:                "*Identify criteria*" for selection of approaches to incorporate LID into state stormwater policy.
- Experiential aim:            "*Identify similarities*" in the approaches recommended by different partners in the group.

Card storming was initiated with the following question to the partners: "What are the features of good LID policy?" The card storming question and aim were posted on blue cards for the group of participants to consider during the session.

The card storming process worked as follows:

- Participants spent five minutes individually identifying three to five word answers to the card storming question (What are the features of good LID policy?). Each answer was written on a 5" x 8" half-sheet of paper (card).
- Participants were asked to pair up with one other person to review their cards and select the clearest answer from the 10 reviewed. The card with that answer was then posted on an adhesive clothe (sticky wall) hung on the wall of the auditorium.



- The group was then asked to identify pairs of answers (e.g., if one pair of participants posted “flexibility” and another posted “flexible implementation” the group might identify these two postings as a pair). *Photograph 3.1* (below) shows the sticky wall after the first round of postings and pairing exercise. During this exercise the group identified two pairs and two triplets. Triplets are not typical; however, in this particular case there were two natural groups of three.



**Photograph 3.1**—Sticky Wall after first round of postings and pairing. The card storming question and aims are posted on blue half-sheets of paper in the upper right and left corners of the Sticky Wall.

- Participant pairs were then asked to revisit their answers to the card storming question and identify two more ideas which had not been posted during the first round.
- Participants were then asked to review the posting to identify and group like answers to the card storming question. This part of the exercise is referred to as “clustering.” Once clusters were developed a shape card (i.e., orange half-sheet of paper with a shape (e.g., star, square, circle, etc.) drawn on it) was assigned to each group (see *Photograph 3.2*, below). Participants also began a process of assigning names to each cluster.

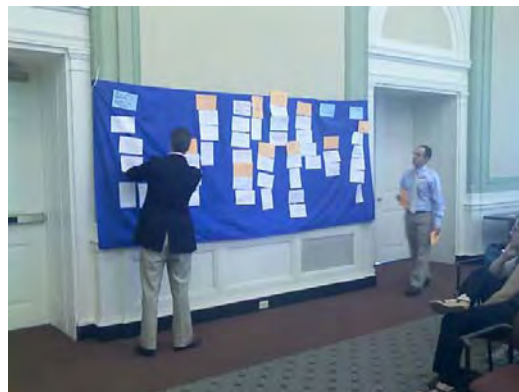

**Photograph 3.2**—Groups or “clusters” of card storming answers being assigned shapes.

- Participants were asked to review their card storming answers one final time and to identify any answers, which were not yet represented on the Sticky Wall.

At this point, the exercise was suspended due to time constraints. On July 1, the card storming was reinitiated as part of Workshop 2. Final results of this process can be found in the meeting summary for Workshop 2, which is provided in *Appendix D*.

Results of the card storming suggest potential alternatives for implementation as well as the characteristics that alternatives should embody. This information can be used to inform both the development of alternatives and the process for selecting alternatives. For the purposes of Technical Memorandum 1 (*Section 3* of this report), we were primarily developing alternatives. A process for selecting alternatives for implementation was developed as part of Technical Memorandum 3 (*Section 5* of this report).

As a starting point in identifying alternatives, we selected elements from the results of the card storming that we believed translated more readily to alternatives and shown them in blue text (see next page).

## RESULTS OF CARD STORMING FROM JULY 1, 2010 (WORKSHOP 2)

**Card Storming Question:**  
What are the features of good LID policy?

**Objective Card Storming Aim:**  
Identify criteria [for determining alternatives]

**Experiential Card Storming Aim:**  
Identify similarities [in participants ideas of good LID policy]

-  **Economic Market Viability**
- Cost effective options, not regulations
  - Enough **incentive** to achieve success
  - Recognize **market demands** for different development types (LID may not be for all)
  - **Funding for implementation**
  - Market/demand sensitivity
  - **Effectiveness can be verified** and maintenance is not cost prohibitive

-  **Education**
- **Education component**
  - Knowledgeable design engineers **training, train**
  - Use good science and knowledgeable people to make decisions
  - Public acceptance—meaning willingness to act a local/residential scale
  - **Greatest behavior change** Promote policies (regulatory and/or voluntary) that result in greatest behavior change

-  **Clear and Understandable**
- Clarity
  - **Uniform statewide (standardized)**
  - Make any guidance and/or standards simple. Make process certain.
  - **LID policy at the local level** to adopt, enforce, implement

-  **Practicability-Flexibility**
- Practical to implement and maintain
  - Not burdensome to individuals, easy to comply with
  - **Maintenance required**
  - Flexible
    - Consider site constraints
    - Consider project type
  - Flexible
  - **Room for innovation**
  - Performance based (about objective, not technique)
  - Bottom-up **site specific approach**, not top down.

-  **Legal Administrable**
- Easy to administer
  - Aligning municipal zoning subdivision regulations (with LID)
  - Encouragement TPZ, cons[ervation] subdivision regulations
  - Available **support structure mechanism** for contractors/homeowners implementing LID
  - Compatible with other regulations and goals that are necessary i.e., ADA, mosquito control, public safety, public health
  - Legal
  - Oversight from local and state agencies
  - Enforceability
  - Treats stormwater runoff with the same strict criteria that are required of on-site septic systems
  - **Quantifiable-measurable for other permit requirements** that might duplicate
  - Should be expected and standard operating procedure not as the exception

-  **Environmental Benefit**
- **Manages soil erosion**
  - **Reduction of impervious materials**
  - **Remediates already built areas**
  - Promotes **GW recharge**
  - **Water quality & water quantity** (groundwater (in-stream recharge) flow techniques)
  - **Reduces runoff**
  - **Minimize impervious cover**
  - **Fix impairment**
  - Resource based design (e.g., soils)
  - Allow soil microorganisms to work
  - Shift focus from engineering to conservation

From this information, we conclude that alternatives for implementation should in part include consideration of the following elements:

- Incentives
- Market-based approaches
- Funding for implementation
- A process for verifying effectiveness
- An education component
- A training component
- A component focused on behavior change
- A uniform statewide standard
- Local-based policy
- Maintenance requirement
- A process for considering innovation
- A site specific approach
- Support structure for the regulated community
- A quantifiable-measurable approach to translate management across multiple permitting programs
- Soil erosion management
- Impervious cover reduction
- Remediation of built areas and impairments
- Groundwater recharge
- Water quality
- Runoff reduction

### 3.3.2 Workshop 2 Carousel Activity

On July 1, 2010 a workshop was conducted with the project partners, which in part included a carousel activity. The carousel activity focused on participant identification of strengths, weaknesses, benefits, and dangers; but also included an opportunity for participants to identify alternatives for implementation. Prior to the carousel activity a list of potential (i.e., example) implementation alternatives was provided and discussed briefly. The list is provided below:

#### 1. **Regulation (e.g., write LID into general permits (GPs) or another regulation)**

*Example suggestions:*

- Require use of LID at 100% of sites
- Require LID at some sites (these options are not necessarily exclusive of each other)
- No regulatory/legal requirement for LID

## 2. Nonregulatory

*Example suggestions:*

- Guidance with LID standards
- Training/Education
- Incentives for using LID
- Demonstration projects



Photographs 3.3 – 3.6—Carousel workshop in process.

## 3. Performance standards for LID by guidance or regulation

*Example suggestions:*

- Set one or more required standards (e.g., runoff volume/flow rate, pollution removal, etc.)
- Set interchangeable bench marks/performance standards (this requires determination of equivalency between standards)
- Allow designers to select from a menu of options (WQV, infiltration set-aside, impervious surface disconnection/reduction)

## 4. Set a pollution reduction standard in guidance or regulation

*Example suggestions:*

- General standard (e.g., 80% TSS reduction)
- Sensitive site standard(s)



- Based on monitoring
- Based on design and assumed pollution reduction rate

## 5. Stormwater utility districts

*Example suggestions:*

- Do nothing/don't clarify statutory issues
- Make statutory revisions

Six carousel stations, including a flip chart and set of colored markers, were set up in separate parts of the meeting room. Five of the stations were used to represent each of the five alternatives listed above. A sixth station was set up to create an opportunity for participants to add new alternatives. The carousel activity was conducted as follows:

- At their seats at the start of the carousel activity, participants were given 12 minutes to list five pros and five cons for each of the five alternatives. Participants were also asked to list three alternatives that had not yet been considered.
- Participants then split up randomly into six groups and each group was asked to pick a “reporter.”



**Photographs 3.3 – 3.6—Carousel workshop in process.**

The participant groups were allowed five minutes at each station to:

- List five strengths, five weaknesses, five benefits, and five dangers of each of the five alternatives
- List alternatives that had not yet been recommended at Station 6,
- At the end of the carousel, reporters were asked to present the full set of findings (2 minutes for each reporter) at the last alternative the reporter visited.

Final results of this process can be found in the meeting summary for Workshop 2, which is provided in *Appendix D*. The list of alternatives from Station 6 of the carousel activity is provided below:

## 6. ADDITIONAL ALTERNATIVES

- Hybrid of “5” alternatives – current approach does not translate to local level (similar to how wetlands) Bottom up- driven by town.
- Compliance with water quality standards
- Public participation
- Mandating retrofits
- Educational component/program (officials, public)
- Other non-structural controls (e.g., street sweeping)
- Stricter enforcement
- Make all P+Z [planning and zoning] follow same rules for stormwater management
- IC [impervious cover] cap and trade
- Incentivize water reuse (i.e., on water bill)

This list adds several alternatives to the list provided in *Section 3.3.1* of this report. Specifically, the additional alternatives include:

- Education for public officials
- Nonstructural controls (e.g., street sweeping)
- Impervious cover cap and trade
- Incentives for water reuse

## 3.4 Applications in Connecticut

As a result of the research on state programs, partner interviews, and activities conducted during workshops 1 and 2 it became possible to identify potential building blocks for the implementation of a LID-based stormwater program in Connecticut. The remainder of *Section 3.4* discusses those building blocks in terms of:

- Performance goals and criteria for LID/pollution prevention
- Performance goals and criteria for the general permits
- Approaches to giving LID priority attention
- Other elements of LID programs

These approaches were used as a starting point in developing specific alternatives, which are discussed in *Section 5.0* of this report.

### 3.4.1 Performance Goals and Criteria for LID/Pollution Prevention

The following descriptive list was used as a starting point for consideration of establishing performance goals and criteria for management practices common to LID/pollution prevention and SGP implementation.

- WQV – Most states use WQV as a method to measure stormwater treatment effectiveness. States that have incorporated LID typically link treatment provided by LID to WQV either directly or indirectly (e.g., through a “credit” system). When asked how LID should be demonstrated, partners expressed a difference of opinion on the most appropriate methods; however, more partners expressed a preference for the use of WQV than any other method of performance demonstration. A common method used by other states to demonstrate incorporation of LID is to require that a fraction or percentage of the WQV is managed with LID. For example, the San Francisco RWQCB has developed a municipal regional stormwater Permit / Order that mandates water quality goals to be “accomplished primarily through the implementation of low impact development techniques.” The permit specifies that LID must be used for 100% of the water quality volume treatment. Connecticut could establish a LID-incorporation standard, which could be set between 1 – 100%. Setting of the standard could be based on a variety of factors such as economics, site-specific environmental concerns, general ability of the regulated community to implement, etc.
- Impervious Cover Cap and Trade– Impervious cover cap and trade was suggested during the carousel activity of Workshop 2. Based on our research it has not been implemented in other Phase 2 Stormwater jurisdictions; however, it is an approach used to govern air emissions. To implement the approach, Connecticut could place a cap on the amount of impervious cover allowed in a regulated area or industrial sector and apportion units of impervious surface to entities (i.e., land owners) within the area or sector. The state could set a unit value (e.g., \$50,000 an impervious acre) or allow the



market to self-set a unit value through trading. Trading could be allowed between entities with oversight provided by the state. Adding to the approach, the state could allow applicants to “purchase” additional units of impervious surface based on the market value. Proceeds could be deposited in a stormwater quality remediation bank.

- Set-Aside for LID – Wisconsin has established a set-aside requirement for infiltration. Under this approach 1 - 2% of any land included in a development project must be reserved for infiltration practices. A similar approach could be established in Connecticut for LID.

### 3.4.2 Incorporating Performance Goals and Criteria in General Permits

This section discusses how performance goals and criteria can be effectively incorporated into Connecticut’s SGP to meet permit limits and conditions. As described in *Section 3.2.2.3.3* (above), during each of our interviews with partners, we asked:

*How do you think they [LID practices] should be incorporated into DEP policy?*

- a. By reference to a document*
- b. Specific standards*
  - i. Narrative standard*
  - ii. Prescriptive design standard*
  - iii. Numeric standard*
  - iv. Performance standard*
- c. Other methods*

Responses to this question provide no clear consensus on an implementation approach. In fact, many respondents specifically stated that they were unsure, unqualified to answer, or needed to give the matter further consideration; however, generally speaking, interviewees that provided a specific response seemed to be calling for flexibility by indicating preference for guidance (26% of respondents) and performance standards (26%). Responses were essentially split on whether or not to regulate, with no regulation being preferred by five respondents and regulation being preferred by six respondents.

We would expect this sentiment to be common in other states as most states that include LID in regulation have established hybrid approaches that involve flexible regulation, guidance and performance standards. Findings from state reviews indicate other regulatory agencies use one or a combination of these methods.

- A LID manual established as guidance only. In Connecticut, a LID stormwater document could lay out a LID process as well as discuss BMPs and performance criteria for implementation. SGPs could reference the LID manual as a guidance document.
- As an alternative to the method discussed above, Connecticut could develop a LID manual but opt to not reference it in the SGPs.

- Incorporate LID directly into SGPs or into regulation or policy. Performance goals and criteria could be established in the SGPs or regulation. Flexibility could be incorporated into this method by either requiring or encouraging LID. Several states have taken similar approaches in combination with a design manual.

As part of developing new standards, partners have stated that the standard should be a uniform, statewide policy that is adopted at both the state and local levels and that standards implemented should translate across multiple permitting programs. Additional features of such policy might include:

- Water quality standards.
- Soil erosion standards.
- Groundwater recharge standards.
- Runoff reduction standards.
- Impervious area reduction standards.
- Maintenance requirements.
- Process for verifying effectiveness.
- Process for considering innovation.

### 3.4.3 Giving LID Priority Attention

In the interviews we conducted with partners, most interviewees (18 of 27) expressed a desire to include LID as BMPs of choice versus end-of-pipe BMPs. A number of respondents pointed out that such a requirement should include flexibility to address situational issues.

As discussed in *Section 3.1.4* (above), standards used by other states to develop primacy of LID over end-of-pipe controls include:

- Requiring that a percentage of runoff volume is managed using LID.
- Requiring set-aside of an area of a site for LID (e.g., Using a related approach, Wisconsin requires set-aside of 5% of each development site for infiltration).

Existing impervious surface area reduction requirements could be used at redevelopment sites to reduce the need for end-of-pipe BMPs. This approach is currently being used in Rhode Island. The standards could be written to address other situational issues such as soil type and specific water quality concerns.

### 3.4.4 Additional Suggestions for Elements of a LID Program

- Permitting Process that Includes Flexibility – A number of partners have stated the need for flexibility in stormwater and LID policy. Connecticut could use the general permit to provide significant flexibility for projects that meet certain criteria and achieve

certain performance standards. For example, applicants could be allowed to use a general permit for all projects that incorporate a certain fraction of LID as part of their water quality treatment provided that the designer is properly trained. Permitting for such projects could be limited to a notice of intent. Other projects, because they have potential to present a great risk to the environment, could be required to obtain individual permits.

- Training, Education and Behavior Change— Training, education, and behavior change were raised as important aspects of implementation during both the partner interviews and through workshop activities. These elements of implementation could be included in both regulatory and nonregulatory aspects of LID incorporation. For example, Connecticut could establish a LID designer licensing or certification process for design professionals and developers. This certification would have to be renewed periodically. Training could be offered through an institute of higher learning such as the University of Connecticut. Essentially, a continuing education process such as this would allow stormwater program managers to ensure the appropriateness of information provided to developers using LID in Connecticut. Such a program could be incentivized by allowing certified/licensed designers to submit designs under a GP that provides extra flexibility and limits regulatory oversight. Behavior change (i.e., the appropriate use of LID in designs) could be measured before and after the implementation of the training program.
- Approach to Enable Stormwater Utilities – DEP has included consideration of stormwater utilities as part of this project to evaluate the incorporation of LID in general permits. Stormwater utilities were addressed in partner interviews. Specifically stormwater utilities could provide a revenue stream at the local level and could allow for stormwater management on a regional (e.g., watershed) basis. A full discussion on the potential use of stormwater utilities in Connecticut is being developed for this project as part of a technical memorandum.
- Financial Incentives--Grant Programs for LID – During the partner interviews and workshops 1 and 2, several participants specifically identified incentives, funding and other support for the regulated community as important elements of implementation of LID policy. Previously, Connecticut has offered some grants for LID projects (e.g., Farmington River Enhancement Grant Municipal Land Use Evaluation Project for Village Center and Low Impact Development Guidelines and Regulations). Connecticut could structure LID grants to create a pilot program for statewide LID implementation. Additional incentives for LID implementation at the local level could include technical assistance, delegation of authority, and reduced regulatory oversight.
- Remediation of Built Areas and Impairments—During the workshop activities and partner interviews, several partners suggested that LID policy should include remediation of water quality issues in built areas as well as restoration of impaired waters. Phase II stormwater policy includes a mandate to address stormwater load reductions required pursuant to total maximum daily load (impaired water) studies. To further this, DEP could include consideration of LID as part of new TMDLs. Some

state stormwater manuals also include requirements to reduce impervious surface as part of the redevelopment of currently developed properties. When developing such policies, consideration should be given to their effect on the development community and urban renewal.

## 4 Evaluating the Role of Stormwater Utilities

Stormwater utility districts are used to establish a dedicated revenue stream and alleviate the need to compete for general taxation revenues with other municipal programs. A dedicated funding source, such as a utility district, can provide an important advantage for communities that are attempting to routinely maintain and upgrade their stormwater infrastructure.

Stormwater utilities provide another key advantage. Utilities allow regional (e.g., municipal, county, watershed, etc.) management of stormwater on an ongoing basis. This is an area of limitation for LID, which provides management on a site-by-site basis. Utilities may fill an important stormwater management role in that they overcome the limitations of site-by-site management and may help to implement watershed-based planning.

This section evaluates the potential for stormwater utilities to enhance the implementation of low impact development policies and programs. There has already been some work done in Connecticut involving the assessment of stormwater utility feasibility. This summary incorporates information from those efforts. This along with examples of successful stormwater utilities elsewhere in the country form the basis of our assessment of whether stormwater utility districts currently make sense in Connecticut and if not, whether they could become viable in the future.

---

### 4.1 The Nature of Stormwater Utilities

#### 4.1.1 What is a Stormwater Utility District?

In 2004, the Connecticut Office of Legal Research (OLR) was asked to determine whether or not “changes in state law [would be] needed to create a stormwater utility” (Frisman, 2004, p.1) (see *Appendix J* for OLR report). A necessary part of such a determination was to define a stormwater utility. In their determination, OLR defined a stormwater utility as “a special assessment district that imposes a user fee to fund stormwater management” (Frisman, 2004, p. 1).

At their legal base stormwater utility districts are just as OLR defined them; however, in practice their role can be quite a bit broader. In addition to revenue generation, they may provide all the functions of a fully realized stormwater management program such as:

- Infrastructure operation and maintenance
- Capital improvements (e.g., retrofits)
- Watershed management (e.g., TMDL implementation and management of sensitive (receptors))

- Design review
- Phase 2 implementation
- Technical assistance for the regulated community
- Technology demonstrations
- Public education and outreach
- Flood protection and management

The principal difference between a stormwater utility district and a typical municipally run stormwater management program is that a utility district has the authority to charge a user fee, which becomes a dedicated source of funding for its operations. This means that the utility district can act independently of the municipal politics and administration associated with the general fund and general taxation process.

## 4.1.2 What Might Stormwater Utilities do in Connecticut?

### 4.1.2.1 Connecticut's Current Status

Currently no stormwater utility districts operate in Connecticut (Frisman, 2004); however, in June 2007, Governor Jodi Rell signed into law Public Act 7-154, also known as the Municipal Stormwater Authority Pilot Program. This law allowed for grants for up to four communities interested in examining stormwater utility districts. It also allowed for the formation of such districts by participating communities within their municipal boundaries if stormwater utility districts were desired upon completion of the grant studies.

Three communities opted to participate in this program—New Haven, Norwalk, and New London. Based on review of an interim draft report (January 2009), each community has considered a utility district to assist with implementation of Phase 2 Stormwater and other stormwater management issues such as flooding and upgrade of aging infrastructure. Of the three, New Haven is the only community that has expressed a clear interest in forming a district; however, New Haven also indicates that such a district is not fiscally practical without regionalization. As described on page 5 of the *Stormwater Pilot Program Interim Report*:

The preliminary findings indicate that it is advantageous for the City [of New Haven] to move forward with establishing a user fee system for stormwater management under one or more of the available organizational structures. The user fee system provides an opportunity to equitably allocate costs to users, establish accountability, provide focused management for the stormwater program, develop and implement a better capital improvement program, facilitate public education and participation, and improve level of service and environmental compliance. The City, however, recognizes that the ability to provide a fiscally-responsible means to balance the goals of stormwater management and a cleaner Long Island Sound is predicated in large part on regional cooperation and participation. Management of the stormwater issues impacting the City and the Long-Island Sound is best accomplished on a water-shed basis that does not recognize municipal authority boundaries. Moreover, without participation of the upstream entities, the impact to the receiving waters may be offset by the continued introduction

of contaminants from upstream regions. Thus, the issue of watershed-based authorities should be given careful consideration in order to provide maximum impact to the receiving waters.

The City is proceeding with additional analysis and stakeholder meetings to identify the best organizational structure and user fee implementation program to address the City's anticipated stormwater management program needs.

(Malcolm Pirnie (Interim Draft), 2009)

#### *4.1.2.2 Implementation in Other States*

Since no stormwater utility districts currently operate in Connecticut and it is uncertain how they might work here, this report looks outside Connecticut to examine stormwater utilities in other parts of the country. Some examples of activities carried out by stormwater utility districts in other parts of the country include:

- Operation and maintenance of stormwater infrastructure.
- Retrofit of stormwater infrastructure.
- Watershed management related to stormwater issues, TMDL implementation.
- Drainage design review for permitting purposes.
- General permit (i.e., Phase 2 Stormwater) implementation.
- Technical assistance programs for drainage design and stormwater management enhancement.

The following table was compiled based on a search of web-available information on stormwater utility districts in other states. The table shows some common uses for stormwater utility districts and the implementation focus of seven communities in seven states.

**Table 4.1  
Features of Seven Stormwater Utility Districts**

	Operation & Maintenance	Capital Improvement (e.g., Retrofits)	Watershed Management & TMDLs	Design Review	Phase 2 Implementation	Technical Assistance	Demonstration Projects	Public Education	Flood Management
Alexandria, VA	✓	✓	✓	✓	✓			✓	✓
Northeast, OH	✓	✓	✓		✓	✓	✓	✓	✓
Volusia County, FL	✓	✓		✓					✓
Peachtree City, GA	✓	✓							
Symrna, TN		✓	✓		✓			✓	✓
Newton, MA	✓	✓						✓	✓
S. Burlington, VT	✓	✓		✓	✓	✓			✓

#### *4.1.2.3 The Concept and Potential Benefits of Regionalization*

Regionalization refers to the implementation of a single stormwater management program or stormwater utility district in a group of municipalities (e.g., county level, watershed level, etc.). Such an approach may be excluded under current Connecticut state law. However, from an efficacy and environmental standpoint, capacity to regionalize represents a key element of the stormwater utility district concept. Regionalization realizes economies of scales in program implementation and allows watershed-based implementation. Why are economies of scale and watershed-based management important?

- Importance of economies of scale – Municipalities currently struggle to set aside funding for stormwater management. This is largely due to the competition for scarce tax dollars available in the general economy. While a user fee system such as a stormwater utility district eliminates this competition, it does not make the pool of funding in the general economy any less scarce. Simply put, expanding stormwater management services will increase cost and that burden will be transferred to entities in the utility service area. However, this cost burden may be reduced—or perhaps even eliminated—by improving the efficiency of the existing institutional structure under which services are provided. Regionalization is one tool for improving institutional efficiency because it allows for shared use of labor, equipment and capital resources.
- Importance of watersheds as a unit of management – Because the surface water features and stormwater runoff within a watershed ultimately drain to other bodies of water, it is essential to consider these downstream impacts when developing and implementing water quality protection and restoration programs such as stormwater utility districts.



Regionalizing stormwater management using watershed as the basis for identifying the service area facilitates watershed-based programs.

#### 4.1.3 How Might Stormwater Utility Districts Help to Implement Low Impact Development?

LID represents a shift in the existing paradigm of stormwater management. To make this shift effectively will require that developers and other on-the-ground implementers receive significant support. Such support may need to be both technical and financial in nature.

- Subsidies for LID demonstration – Initial attempts to use LID may be sidelined by the market demand for inexpensive stormwater management. However, initial costs likely reflect a learning curve rather than the real cost of using LID. A utility, set up to provide the public good of effective stormwater management, could subsidize LID demonstrations and help to overcome the learning curve. Could this same subsidy happen through general taxation revenues? Of course it could, but such a subsidy is much less likely to occur in a financial climate that pits it against other general municipal needs (e.g., education).
- Operation and maintenance – A frequent objection to the use of LID is the concern of how to maintain LID practices. Municipal public works departments often struggle to find the resources needed to maintain conventional infrastructure. Newer approaches like LID present the challenge of learning to deal with something new and different. Stormwater utility districts, which specialize in stormwater management, could fund LID operation and maintenance training to DPWs or could fund maintenance services. Also the design review process could be used to ensure appropriate design and adequate access for LID operation and maintenance. For example, in some areas where LID has been implemented, LID integrated management practices (i.e., structural BMPs such as bioretention) must be installed in common spaces to facilitate access.
- Technical assistance in designing and installing LID – Because stormwater utilities specialize in stormwater, they could afford to fund specialty services in LID. These services could include assistance in effective LID design and installation.
- Retrofits for water quality improvement – Recent focus on stormwater as a source of impairment to waters of the state has created a burgeoning need for enhanced stormwater pollution abatement. LID is an increasingly important tool for retrofitting storm drain systems that lack effective treatment practices. Because stormwater utility districts exist to manage stormwater, they are ideally suited to efficiently implement LID retrofits.

#### 4.1.4 What are the Disadvantages of Stormwater Utility Districts?

Along with their advantages, stormwater utility districts bring a number of significant disadvantages. These disadvantages may be of particular importance for established communities such as those in many areas of Southern New England where residents have become accustomed to a particular way of life and cost of living. As of 2008, the US Environmental Protection Agency found that 800 stormwater utility districts had been implemented countrywide. In New England, five such districts exist:

- Chicopee, Massachusetts
- Lewiston, Maine
- Newton, Massachusetts
- Reading, Massachusetts
- South Burlington, Vermont

(EPA, 2008)

Each of these districts formed in response to a significant environmental concern. In many cases stormwater utility districts are unable to gain political traction without the presence of an urgent water quality concern. For example:

- Chicopee, Massachusetts formed a stormwater utility district following enforcement action by EPA. EPA suggested that the city form a district to ensure revenues needed to address stormwater issues.
- Lewiston, Maine formed a stormwater utility district to address impairment to Hart Brook.
- Newton, Massachusetts formed a stormwater utility district to address impairment to the Charles River.
- Reading, Massachusetts formed a stormwater utility district to address impairment to Ipswich River, which dries out each summer as a result hydrologic impacts due to development.
- South Burlington, Vermont formed a stormwater utility district to address nutrient impairments to Lake Champlain.

Commonly cited perceptions regarding disadvantages of stormwater utility districts include the following:

- Increased bureaucracy – Stormwater utilities represent new and additional government. Government presents inherent inefficiencies. If utility districts are given development review authority such reviews will add to permit review times and will add uncertainty to the land development process.

- New fees perceived as taxes – Although a fee-for-service is not a tax, utility district fees are often viewed as new taxes. Those in opposition may refer to a utility district fee as a “rain tax.” This concern is understandable. Implementation of a utility district fee is not typically accompanied by a commensurate decrease in general tax and thus represents an increase in the cost of landownership.
- Basis for fees is unclear and, therefore, arbitrary – A common approach for establishing stormwater utility district rates is to base them on area of impervious surface; however, the general public often has difficulty understanding the concept of impervious surface and grasping the link between it and stormwater management.
- Utilities are politically untenable – Whether or not deserved, the perception of utilities as increasing bureaucracy and tax burden creates a natural opposition to them in the voting public. Overcoming such opposition may be politically infeasible in many communities. Elected officials are well aware of the political risk around stormwater utilities and many times won't even entertain sponsoring or supporting them.
- May require a significant public campaign to generate support – Since the concepts of stormwater management are often viewed by the general public as complex and esoteric; and since the new fees associated with a utility district are generally unpopular, establishing a stormwater utility district typically requires a public education campaign and significant patience on the part of utility district proponents.

---

## 4.2 When Should Stormwater Utilities be Considered?

### 4.2.1 To a Large Extent, Financing Follows Function

The multifaceted nature of most stormwater management programs may call for a diversified funding approach including grants, loans, and a revenue stream such as general taxation proceeds or revenues from a fee-for-service such as a utility district. Typical categories of stormwater management program function include:

- General administration such as clerical and personnel support functions.
- Financial management such as debt service, revenue management and accounting functions.
- Planning, which include program planning, special infrastructure studies and water quality management planning.
- Engineering including functions such as infrastructure project management, drafting and design work.
- General operations such as routine maintenance.
- Regulation including permitting and enforcement.

- Capital improvement including planning for system expansion and major retrofit initiatives.

The functions of a stormwater program determine which funding approaches make sense. For example, while grants may make sense for financing special projects, they are inappropriate for funding operation and maintenance programs or as the sole source for infrastructure improvement due to their limited and uncertain availability. Bonds make an excellent financing option for infrastructure improvement, but are typically not acceptable for staff and routine operation costs. Service fees and special taxes present strong funding mechanisms for predictable costs such as operations and labor, but work less well for funding or unanticipated costs associated with special projects.

#### 4.2.2 More Than One Approach May Work

A wide variety of options exist to fund stormwater management. Treadway (2000) breaks these down into two categories—primary and secondary—which refers to the flexibility of their potential application. The methods are summarized in *Table 4.2*, below.

**Table 4.2**  
**Categories of Stormwater Financing Methods**

<b>Category</b>	<b>Financing Method</b>	<b>Typical Use</b>
Primary—Characterized by maximal application flexibility	General fund Utility funds/fees for service	General operations, administration and finance management
Secondary—Characterized by use restrictions and conditions	Impact fees Development review fees Permitting fees In-lieu-of fees	Offset for externalities of development
	Grants Bonds Special assessments	Capital improvements and special projects

Source: Adapted from Treadway (2000).

Municipalities currently use a variety of specially designated fees to offset the municipal costs associated with reviewing development projects and their long-term impacts. The subdivision review process is a good example.

Many municipalities also access grants, bonds and may establish special assessments on an as-needed basis to fund capital improvement and special projects. Good examples of sources of funding for special projects include DEP’s Nonpoint Source Management Program and the State Revolving Fund.

Connecticut communities rely heavily on general revenues to fund stormwater management operations. General funds provide a clear advantage over utilities districts and fees-for-service as the mechanisms to acquire these revenues already exist and enjoy well-established public

acceptance. Notwithstanding, reliance on general funds presents a significant disadvantage in that their user-programs must compete to gain access. Funding competition typically results in constrained and somewhat unreliable budgets and can hamper compliance with regulatory requirements such as those under Phase 2.

Stormwater utility districts can be used to established a dedicated revenue stream and alleviate the need to compete for funding with other municipal programs, but does a district make practical sense? *Table 4.3* provides a comparison of the advantages and disadvantages of financing through general revenues and utilities.

**Table 4.3**  
**Practical Considerations Related to**  
**General Taxation and Utility Fees as Sources of Revenue for**  
**Stormwater Management**

	<b>General Fund Revenues</b>	<b>Stormwater Utility</b>
Political Acceptance	Many competing programs for a resource limited by the will of the elected officials to impose taxes	Required community support and the political will to create a new funding source based on fees
Equity or Cost/Benefit	Impacts only those who pay general fund revenue sources, and is not related to the cost of services	Fee for services received and imposed on all those who contribute to need for services.
Feasibility	Political will is needed to ensure consistent funding. Funding may be subject to political cycles	Requires mechanism for billing fees and administering utility. Statutory authority plays a critical role
Administration	System must be in place to dedicate proceeds from the general fund and to ensure funding integrity	Once rate base and billing file is created, relatively easy to maintain
Legal Structure	Typically allowed and functioning already	Need to verify that authority exists, and if not, authority must be obtained
Funding Level	Must compete with other priorities of the organization for operating and capital expenditures	Dedicated source of funds for program, allowing the use of fees for debt payment, operating costs, and capital improvements

Source: Adapted from Treadway (2000).

### 4.2.3 Adequacy of Potential Funding

If the cost of managing stormwater exceeds the funding realistically available from the general fund, municipalities may need to default to the implementation of a user fee.

Studies conducted on municipal stormwater programs indicate a wide range of potential cost. EPA's "Funding Stormwater Programs" fact sheet indicates costs from about \$8.00 per single-family property per year to about \$160.00 with an average cost of \$44.00 depending on programmatic make-up (EPA, 2009). This fact sheet also gives a general context for stormwater management fees in the New England area. In 2008, Newton, Massachusetts single-family homeowners are charged \$25.00 per year. In Burlington, Vermont single-family homeowners are charged \$56.00.

How should a municipality estimate the overall cost of managing a future stormwater management system? There are many methods. Some include estimation based on model programs, surveying other community programs, and applying cost algorithms. *Table 4.4* provides an alternative method of estimating stormwater management costs based on acres served by the stormwater management program.

**Table 4.4**  
**Typical per Acre Costs of Stormwater Management Programs**  
**Based on Level of Implementation**

<b>Program Level</b>	<b>Program Cost per Acre Served per Year<sup>b</sup></b>	<b>Typical Program Features</b>
Incidental	\$20 - \$40	Reactive incidental maintenance, and regulation as part of other programs
Minimum	\$40 - \$80	ADD <sup>a</sup> : right-of-way maintenance, better regulation and inspection, more staff, and erosion control
Moderate	\$80 - \$120	ADD: additional maintenance programs and levels of service, better regulation and inspection, some planning, minor capital programs, and general upgrade of capabilities
Advanced	\$120 - \$200	ADD: maintenance (of some sort) of the whole system, master planning, regional treatment, some water quality, data collection, multi-objective planning, strong control of development and other programs, and utility funding
Highly Advanced	Over \$200	ADD: Stormwater quality, advanced flood control, advanced levels of service for maintenance, aesthetics become more important, and public programs

Notes:

a "ADD" means to add on this stormwater management feature to the features shown in the above column cells.

b Adjusted from original to 2009 dollars assuming 3% per year cost increase.

Source: Adapted from Treadway (2000).

Regardless of the method used, municipalities should carefully consider that these approaches provide rough cost estimates. Though they provide a good starting point, actual costs may vary substantially from these estimates.

---

### 4.3 What Authority Exists in Connecticut to Implement Stormwater Utility Districts?

Although Public Act 7-154 provides the authority for three Connecticut municipalities to form stormwater utility districts, general authority for municipalities to implement stormwater utility districts may not be present in state law. In 2004, the question of whether such authority existed was posed to OLR. An excerpt from their response to this question is provided below:

State law does not now explicitly authorize the creation of municipal stormwater districts, although the law does authorize towns to operate and maintain sewer and drainage systems, and to regulate the flow of surface water in some circumstances (CGS §7-148(c)(6)(B)). The law also permits municipalities to establish WPCAs, which also may regulate the flow of stormwater in certain instances (CGS § 7-247).

To eliminate any doubt about municipal authority to create such a district, the legislature might wish to specifically authorize the formation of such a district. The legislature could authorize creation of independent stormwater utilities or permit existing municipal boards, such as WPCAs [Water Pollution Control Authorities] (CGS § 7-245 *et seq.*) and Municipal Flood and Erosion Control Boards (CGS § 25-84 *et seq.*) to assume the duties of a stormwater utility. It may also wish to consider authorizing several municipalities to join in a regional stormwater utility district.

(Frisman, 2004, p. 2)

As discussed above in *Section 4.1.1*, the essence of a stormwater utility district rests in its ability to assess a fee-for-service for the full cost of operating a storm sewer system, allowing financial independence from municipal general funds. The State of Connecticut currently allows WPCAs to make assessments of benefits for:

A proportionate share of the cost of any part of the sewerage system, including the cost of preliminary studies and surveys, detailed working plans and specifications, acquiring necessary land or property or any interest therein, damage awards, construction costs, interest charges during construction, legal and other fees, or any other expense incidental to the completion of the work.

(CGS § 7-249)

This does not explicitly include administration or operation and maintenance. In fact, it would appear to focus on costs associated with initial system installation only. At a minimum, a specific legal opinion should be sought to clarify OLR's findings. Ideally, local authority to



establish utility districts should be clarified in the Connecticut General Statutes. The authority to regionalize such services should also be considered as discussed above in *Section 4.1.2.3*.

---

## 4.4 Input from Partners on Stormwater Utilities

The degree to which stormwater utilities will be implemented depends largely on the desire of local agencies to implement. The following sections discuss information that has been gathered from the partners on the use of stormwater utility districts through the use of workshops and individual interviews. This section also provides observations from the interview and workshop process. This information can be used as a starting point in determining the level of interest in stormwater utilities at the local level.

### 4.4.1 Interviews

As part of our overall study to evaluate LID, we have conducted 27 interviews with partners on this project. A discussion of the interviews and the interview process is provided in a document entitled “Summary of Partner Interviews.”<sup>5</sup> These interviews addressed a wide range of topics regarding the use and implementation of LID. Part of the interview specifically related to stormwater utility districts and included the following question:

In some states stormwater utility districts charge a fee for service to oversee BMP design review, installation, operation and maintenance. What do you think of the idea of using stormwater utility districts as a regulatory device?

This question presented some challenges for use in the interview. Interviewees had varying levels of familiarity with the concept of stormwater utilities. This may have biased some responses and in at least two interviews led to responses of “unsure” or “no response.” When respondents appeared unfamiliar with stormwater utilities, the interviewer explained their application. Another issue with this question, which may have led to less than clear responses, is the fact that most people, who are familiar with utilities, are familiar with them as revenue generating devices, not as a regulatory device. A number of respondents answered the question with a statement such as “I’ve never considered using utility districts in that way.”

*Table 4.5* presents a summary of interviewee responses to the idea of using stormwater utility districts as regulatory devices. Virtually all interviewee responses were qualified in some way. This included all the “yes” responses, all but two “maybe” responses, and all but one “no” response. One respondent noted that there was specific interest for implementation of a utility district in that respondent’s region, but that actual implementation was unlikely due to political issues.

---

<sup>5</sup> At the time that “Summary of Partner Interviews” was developed, we had conducted 17 interviews. We have conducted an additional 10 interviews since this time. All 27 interviews will be summarized in our first technical memorandum (release pending).

**Table 4.5**  
**Interviewee's Response to the Question**  
**"Should we use Stormwater Utility Districts as a Regulatory Device?"**

<b>Should we use Utility Districts as a Regulatory Device?</b>	<b>Number of Responses</b>	<b>Percentage of Responses</b>
Yes	5	19%
Maybe, Not Sure, etc.	5	19%
No	7	26%
Politically Unlikely	6	22%
Unnecessary Government	8	30%

#### 4.4.2 Workshop 2

Workshop 2 (July 1, 2010) focused in part on the use of stormwater utility districts to enhance LID implementation. Workshop 2 included a carousel workshop to address the strengths, weaknesses, benefits and dangers of five implementation alternatives. Stormwater utility districts were one of the five implementation alternatives. A full summary of the carousel workshop, *Workshop 2 Meeting Summary* dated July 12, 2010, is provided in *Appendix D* of this report.

Below is the resultant list of strengths, weaknesses, benefits and dangers for the use of stormwater utility districts. We have intentionally left the wording, use of colored text, and use of symbols that participants provided during the workshop.

## 5. STORMWATER UTILITIES

STRENGTHS	BENEFITS
<ul style="list-style-type: none"> <li>•Watershed based ✓</li> <li>•Effectiveness</li> <li>•Regional partnerships</li> <li>•Can work if there's an existing organization/group to piggyback on</li> <li>•Removes stormwater from politics</li> <li>•May work for already regionalized water and sewer authorities , e.g., MDC</li> </ul>	<p style="text-align: center;">Local authority and control</p> <ul style="list-style-type: none"> <li>•✓Dedicated "funding" stream for projects</li> <li>•Reduction of IC [impervious cover]</li> <li>•Could adapt to local geographical conditions</li> <li>•Education</li> <li>•Businesses/owners working together</li> <li>•Accountability</li> <li>•✓Comprehensive approach to water management; interrelationship</li> <li>•Raises revue, funds</li> <li>•Taxpayer expectations</li> </ul>
WEAKNESSES	DANGERS
<ul style="list-style-type: none"> <li>•Cost to towns</li> <li>•Legal framework</li> <li>•How measure success?</li> <li>•Cost to regulated community✓ and municipality</li> <li>•Existing IC may have a disproportionate cost</li> <li>•Political will to accept regionalization✓</li> <li>•Removes public input</li> <li>•Regional/town conflicts</li> </ul>	<ul style="list-style-type: none"> <li>•Political conflicts</li> <li>•Public perception – tax**</li> <li>•Overlapping authorities – Need to coordinate authorities</li> <li>•CT legislature won't add a new tax</li> <li>•Is it voluntary for towns or required that every town join/have one?</li> <li>•Who sets fee and how?</li> </ul>

### 4.4.3 Observations from Interviews and Workshop 2

This section discusses general observation from the partner interviews and Workshop 2 exercises. Generally, there appears to be a broad range of perceived positive and negative aspects associated with stormwater utility districts. We offer the following observations:

1. Based on the interviews, there is an approximately even split on whether stormwater utilities should be used as regulatory devices; however, interviewee responses lean somewhat against the idea or unsure about it.

2. A significant percentage of interviewees think stormwater utility district implementation is politically unlikely.
3. Existing regional authorities, such as the MDC, were suggested as an implementing agency. If enabling authority to implement exists in regional agencies, this would overcome the issue of uncertain enabling authority at the municipal level. It may also sidestep some of the political concerns.
4. Certain aspects of stormwater utility districts present contrarily as both strengths and weaknesses. For example:
  - “Watershed based” is listed as, a strength while “regionalization” is listed as a weakness.
  - “Removes stormwater from politics” is listed as, a strength while “political conflicts” is listed as a weakness.
  - “Raises revenue” is listed as a benefit while “public perception—tax” is listed as a danger.
5. Several yet-to-be-answered questions were raised about stormwater utility districts during the workshops:
  - How do we measure success?
  - Who sets stormwater fees and how?
  - Are they [stormwater utility districts] to be voluntary or required?

---

## 4.5 Next Steps

Stormwater utility districts create a dedicated funding source to carry a wide variety of stormwater related functions. Having a consistent funding source can significantly improve the efficacy of stormwater programs, particularly if the programs are carried out at the regional level, where proper focus can be applied on a watershed basis and valuable economies of scale may be realized.

### *Issues to Review*

Despite their benefits stormwater utility districts are not viable in every political and administrative circumstance. *Table 4.2* in *Section 4.2.2* of this report lists a series of issues to review when considering whether or not stormwater utility districts make sense. Through interviews and workshops, the partners on this project have essentially identified four of these as significant concerns:

- Political acceptance—Questions exist as to the political likelihood of being able to pass stormwater utility district ordinances at the local level.
- Legal structure—Analysis by OLR and analysis done for Public Act 7-154 grants indicates that the legal structure does not currently support regional stormwater utility districts and may not support individual municipal stormwater utility districts.
- Equity—Questions exist as to how a fee-setting structure would be implemented.
- Bureaucracy—A number of partners have expressed concern that municipal stormwater utility districts will add bureaucracy and “new layers” of government.

#### *Possible Ways to Address These Issues*

For stormwater utility districts to make sense these issues will need to be addressed.

- One possible way to address some of these concerns is to implement stormwater utility districts through existing regional authorities such as water utilities, wastewater authorities, fire districts, etc. If following this approach is desired then legal research should be conducted to determine legal feasibility. These regional entities may or may not have existing authority and capacity to implement stormwater utilities. Significant capacity building may also need to be conducted. For example, regional planning agencies would need to develop or partner to acquire the on-the-ground capacity needed to implement a stormwater utility district.
- For stormwater utility districts to work at the municipal level, they will, at a minimum, require clear enabling authority at the state level. Ideally, such authority should allow for regionalization. Municipalities would also need to establish local authority (i.e., through a municipal ordinance) as well as administrative capacity.

#### *Concepts to be Developed*

Prior to pursuing stormwater utility districts at any governmental level, fee-setting and bureaucratic structure should be addressed. It may be helpful to develop a model stormwater utility district ordinance and guidance manual for utility district development and implementation in Connecticut. Ideally, the following concepts should be developed:

- A clear and simple fee-setting structure. Will these be new fees added to existing fees and taxes already paid? Will these fees be offset by a commensurate reduction in taxes and fees already paid? How will these fees be calculated? If such a fee-setting structure is developed in the context of a statewide subcommittee, it may have a better chance of addressing the full range of issues it will be tested against. Endorsement by a statewide committee may also give it broader support.
- An agreed-upon bureaucratic and administrative structure. Will this structure be that of a wastewater authority or water commission, for example, with the necessary full-time manpower, infrastructure and equipment? Will this structure minimize the bureaucracy

and be a contracted out service, much as waste hauling is for some municipalities? Will such programs be administered through existing town governance or through a separate body? What regulatory authority will be delegated to a regional utility district from the state and municipalities in the service area? Again, if such a structure is developed in the context of a statewide subcommittee, it may gain greater support.

- A process to build public understanding and acceptance. How will municipalities know if they have the level of public acceptance necessary to establish a stormwater utility district? What is the most effective way to educate the general public about the nature and benefits of stormwater utility districts? Research for this technical memorandum identified public awareness and support as key issues in establishing successful stormwater utility districts. A statewide committee could help to develop a program of education and outreach that could be customized for local implementation.

## 5 Identifying Alternatives for Implementation and Selecting an Approach

*Section 5* discusses the development and selection of an approach to implement LID policy as part of Connecticut's stormwater management programs. Specifically, this section discusses:

- A series of implementation alternatives.
- A rationale for choosing an implementation approach (i.e., one or more of the alternatives).
- A process for selection of alternatives in cooperation with the partners.
- Proposed next steps.

---

### 5.1 Summary of Alternatives

Alternatives discussed in this section are grouped to address the following implementation objectives of this project:

- Incorporation of LID and pollution prevention.
- Incorporation of LID performance goals and criteria in general permits.
- Giving LID priority in the stormwater general permits.

#### 5.1.1 Methods Used to Incorporate LID and Pollution Prevention

The following subsections discuss alternatives that could be used to incorporate LID and pollution prevention into Connecticut's stormwater general permits. These alternatives are based on the information gathered during research on state programs, Partner interviews, and activities conducted during workshops 1 and 2.



### 5.1.1.1 Regulatory Alternatives

The approaches described below involve changes to regulatory policy. Prior to the start of this project DEP identified two regulatory alternatives for implementation. These two alternatives are:

- Incorporating LID through updates to the *Stormwater Quality Manual* and *Soil Erosion and Sediment Control Guidelines*.
- Establishing standards in the Stormwater General Permit.

Sections 5.1.1.1.1 and 5.1.1.1.2 present options for incorporating LID policy and standards into the manual, guideline, and SGP. Although these alternatives have been identified for implementation by DEP, DEP would like the form of the implementation to be determined by the project Partners.

Other regulatory alternatives presented are optional and may be included, discarded, or adjusted as determined by the Partners.

#### 5.1.1.1.1 Incorporating LID through Updates to the Stormwater Quality Manual and Soil and Erosion Guidelines

As part of this project, DEP intends to incorporate LID updates made to the *Stormwater Quality Manual* and the *Soil Erosion and Sediment Control Guidelines* into the SGP. Initially, this will be as a write-up under Summary 5 and Technical Memorandum 4. Generally speaking, the write-up will address the following topics:

- Advantages of managing stormwater using LID.
- Four basic tenets of LID.
  - Examples of BMPs for Minimizing Site Disturbance.
  - Working with Site Hydrology.
  - Examples of BMPs for Minimizing and Disconnecting Impervious Surface.
  - Applying Small-Scale BMPs at the Source.

Through workshops, interviews, and general discussion, the Partners have already identified a number of features of good LID policy and implementation that could be included in the update. Some examples include:

- LID and pollution prevention performance standards.
- Standards for runoff management.
- Groundwater recharge standard.
- A design process for LID.
- Maintenance requirements.
- Soil based standards.
- Process for innovation.



The write-up of the standards could take one of three forms:

- Standalone document that focuses on the LID process and LID standards.
- Appendix to the existing *Stormwater Quality Manual* and *Soil Erosion and Sediment Control Guideline*.
- Full update to the *Stormwater Quality Manual* and *Soil Erosion and Sediment Control Guideline*.

Partners will be offered an opportunity to make a preliminary decision on the form of the write-up during Workshop 3. This preliminary decision will help to inform Summary 5, which will focus on LID standards. Workshop 4 will be used to solidify the preliminary decision.

In general, the advantage of a standalone document or an appendix is that either can be developed fairly quickly and with a pure focus on LID. Updates of both the manual and guidelines will necessitate a more involved process of fitting LID into the structure of the existing documents. This will take substantially longer.

#### 5.1.1.1.2 Establishing Standards in the Stormwater General Permits

Prior to the start of this project, DEP had determined that the *Stormwater Quality Manual* and *Soil Erosion and Sediment Control Guidelines* should be updated to include LID and that the manual and guidelines or LID standards established in the manual and guidelines should be incorporated into the SGP. Three basic approaches have been identified to accomplish this:

- Reference Manual/Guidelines as a Requirement in the Stormwater General Permits

One fairly straightforward way to incorporate LID into Connecticut's SGP is to update the manual and guidelines with LID standards and design processes; and then reference the manual and guidelines in the SGP as a required standard. This approach simplifies regulatory policy by separating it from the relatively lengthy description of the LID design process that is needed to provide appropriate theory and flexibility. This approach also provides a relatively clear and certain standard. However, requiring the use of a specific process may constrain designers and regulators as it limits the process of innovation and professional judgment in atypical circumstances. (The policy of no other state, which was reviewed for Technical Memorandum 1, makes an outright requirement to strictly follow a specific manual or design process.)

To compensate for this apparent shortcoming, the manual and guidelines could be written to include both a relatively strict design process as well as a process for innovation that relies on conservative performance standards. The choice of the "strict" or "innovative" process could be dictated by the permittee or, in applicable circumstances, special site conditions (e.g., presence of approved total maximum daily loads).

- Reference Manual/Guidelines as Guidance in the Stormwater General Permit

As an alternative to a strict requirement in the SGP to use the *Stormwater Quality Manual* and *Soil Erosion and Sediment Control Guidelines*, DEP could reference the manual and guidelines as guidance documents for permitting purposes. This approach is used by a number of states around the country. This approach has the advantage of allowing for some flexibility in application of standard; however, it also creates some uncertainty and indirectly creates the question—if the manual and guidelines are not required, what is the requirement?

- Write Specific Standards from the Manual/Guidelines into the Stormwater General Permit

One way to incorporate LID into state policy without citing the *Stormwater Quality Manual* or *Soil Erosion and Sediment Control Guidelines* is to codify the standard in the SGP. However, because LID essentially employs a *process*, the LID approach is not readily translated into discrete design standards. That said, the designed treatment capacity of LID integrated management practices<sup>6</sup> (IMPs) can be quantified and used as a measure of treatment effectiveness. Research on approaches used by other states revealed two approaches that could be adapted for use in Connecticut.

- Establish a WQV Standard

Most states use WQV as a method to measure stormwater treatment effectiveness. States that have incorporated LID typically link treatment provided by LID to WQV either directly or indirectly (e.g., through a “credit” system).

A common method used by other states to demonstrate incorporation of LID is to require that a fraction or percentage of the WQV is managed with LID. For example, the San Francisco RWQCB has developed a municipal regional stormwater Permit / Order that mandates water quality goals to be “accomplished primarily through the implementation of low impact development techniques.” The permit specifies that LID must be used for 100% of the water quality volume treatment. Connecticut could establish a LID-incorporation standard, which could be set between 1 – 100%. Setting of the standard could be based on a variety of factors such as economics, site-specific environmental concerns, general ability of the regulated community to implement, etc.

- Set-Aside for LID

Wisconsin has established a set-aside requirement for infiltration. Under this approach 1 - 2% of any land included in a development project must be reserved for infiltration practices. Connecticut could develop a similar approach for LID with adjustment for local soils.

---

<sup>6</sup> LID uses the term integrated management practice to refer to small-scale, structural BMPs installed at multiple locations throughout a site. The term IMP is comes from the idea that the management practices are “integrated” into natural hydrologic low points of the landscape. Application of IMPs is one of four tenets of LID. IMPs are generally employed to support stormwater treatment after the available capacity of other LID approaches (e.g., disconnection, minimizing site disturbance, etc.) is exhausted.

Partners will be offered an opportunity to make a preliminary decision on the form of the standard in the SGP during Workshop 3. Later workshops will be used to solidify this decision.

#### 5.1.1.1.3 Designer Licensing

Designer licensing refers to a process that extends certain privileges to designers who maintain good standing under a licensing program. In Rhode Island, RIDEM has developed a designer licensing program for septic system designers and installers. The program allows these professionals to use an abbreviated permitting review process provided that they attend classes, pass a test, and maintain a certain quality of work as determined by spot review of application materials.

Connecticut could establish a LID designer licensing or certification process for design professionals and developers. Under this approach, specific standards would be set and designers would be trusted to meet the standards without regulatory review. To ensure that the designers stay current, the certification could include a requirement for periodic renewal (e.g., every five years). Training could be offered through an institute of higher learning such as the University of Connecticut. Essentially, a continuing education process such as this would allow stormwater program managers to ensure the appropriateness of information provided to developers using LID in Connecticut. Such a program could be incentivized by allowing certified/licensed designers to submit designs under a GP that provides extra flexibility and limits regulatory oversight. Behavior change (i.e., the appropriate use of LID in designs) could be measured before and after the implementation of the training program through spot review of permit applications.

Designer licensing was not specifically suggested during workshops or by Partners, but is an approach that would maintain high design standards, allow for application of a flexible permitting process, while reducing time required for the permitting process. Design licensing could also reduce the administrative burden on regulators and allow them to redirect their energies.

#### 5.1.1.1.4 Impervious Cover Cap and Trade

Impervious cover cap and trade was suggested during the carousel activity of Workshop 2. Based on our research it has not been implemented in other Phase 2 Stormwater jurisdictions (e.g., other states); however, a similar approach is used to govern air emissions. To implement the approach, Connecticut could place a cap on the amount of impervious cover allowed in a regulated area or industrial sector and apportion units of impervious surface to entities (i.e., land owners) within the area or sector. The state could set a unit value (e.g., \$50,000 an impervious acre) or allow the market to self-set a unit value through trading. Trading could be allowed between entities with oversight provided by the state. Adding to the approach, the state could allow applicants to “purchase” additional units of impervious cover based on the market value with proceeds deposited in a remediation bank. An official trading certificate could be used to demonstrate number of units used or traded as part of a development permit.

Two important considerations related to cap-and-trade programs include:

- Collecting fees to build projects off site commonly requires local or state government to provide staff for planning, design, property acquisition and construction of retrofit and restoration projects.
- Developing a fee schedule that reflects environmental costs and benefits in a dynamic market may be impracticable. Developers and regulators may confront situations where cap-and-trade fees undercut the cost of appropriate management practice. In such cases, the cost of environmental protection may be unduly externalized to government or the general public and subvert the intent of the approach.

#### 5.1.1.1.5 Adjusted Standards for Areas or Circumstances of Special Concern

A number of states include flexibility in their stormwater management standards to address atypical circumstances. In some cases, adjusted standards are intended to be more highly protective of sensitive resources. In other cases, the standards are relaxed to encourage infill development or to reduce the burden of stormwater management in areas where it yields diminishing return. Some examples of adjusted management standards include:

- Standards designed to achieve pollutant load reductions for impaired water resources.
- Nitrogen management requirements for nitrogen-sensitive resources such as Long Island Sound or drinking water aquifers.
- Relaxed impervious cover allowances in highly urbanized settings.
- Graduated recharge requirements based on hydrologic soil group.

#### 5.1.1.2 Nonregulatory Alternatives

The following section discusses nonregulatory approaches, which could be used to help implement LID policy. These approaches could be used as a standalone approach to implementation or could be used in conjunction with other initiatives such as regulatory approaches.

##### 5.1.1.2.1 Training Program

A training program could be voluntary or mandatory and, therefore, could be considered as either a regulatory or nonregulatory approach. This report discusses implementation of training programs through both regulatory (i.e., designer licensing, see *Section 5.1.1.1.3*) and nonregulatory approaches.

Training, education, and behavior change were raised as important aspects of implementation during both the Partner interviews and workshop activities. Training could be provided on an *ad hoc* basis through occasional workshops and conferences. Training could also be structured into a series of classes, curriculum, certification, or licensure with a continuing education requirement. Target audiences for training and education might include homeowners, municipal officials, designers, contractors or other members of the regulated community. A grant or other financial allocation could be used to develop a training program or educational series. Training

program development may best be run through a college or university as such institutions already possess many of the resources needed to implement and assess the cost-benefit of a training program.

#### 5.1.1.2.2 Financial Incentives

During the Partner interviews as well as workshops 1 and 2, several participants specifically identified incentives, funding and other support for the regulated community as important elements of implementation of LID policy. Previously, Connecticut has offered some grants for LID projects (e.g., Farmington River Enhancement Grant Municipal Land Use Evaluation Project for Village Center and Low Impact Development Guidelines and Regulations). Connecticut could structure LID grants to create a pilot program for statewide LID implementation. Additional incentives for LID implementation at the local level could include technical assistance, delegation of authority from state to local programs, and reduced regulatory oversight at the state level for effective local programs.

#### 5.1.1.2.3 Technical Assistance

Program implementation tends to be more effective when technical assistance is offered by oversight agencies to implementing agencies. A number of Partner responses during interviews and workshops suggested the need and desire for assistance from the state to municipalities, designers, installers, and landowners. Technical assistance could take the form of assistance in policy review and analysis, support in developing technical standards through research projects, educational and training programs, BMP demonstrations, and experts-on-hand for questions. For maximum benefit, technical assistance could be coupled with guidance materials and financial assistance.

#### 5.1.1.2.4 Public Education

For effective implementation of LID to take place, members of the regulated community (i.e., designers and installers), government, and landowners (consumers) must all cooperate. The regulated community must provide proper design and installation services. Government must provide an appropriate regulatory framework. Consumers must demand quality goods and services and must properly operate and maintain installed BMPs. Consumers will need to be made aware of their role and then behave according to it. Public education is, therefore, important to raise awareness of the consumer public. Public education may take a variety of forms:

- Fact sheets and brochures
- Public service announcements
- Workshops and classes
- Grassroots outreach

Education may also be provided through a variety of outlets:

- Government agencies

- Service providers
- Nongovernmental organizations
- Educational institutions

A public education program could be developed to work through a variety of forms and media and could be delivered through a variety of outlets. Stormwater public education programs have been developed for a number of states and cities. San Diego's Think Blue Program for stormwater—which includes public service announcements, an adaptable program template, and measurement of behavior change—makes a good example. Similar approaches could be created for LID and could be structured to include behavior-change elements and measurement.

### 5.1.1.3 Stormwater Utility Districts

As part of this project to evaluate the incorporation of LID into the SGP, DEP has included consideration of stormwater utilities. To date, no stormwater utilities have been implemented in Connecticut; however, in other states stormwater utilities are generally used to provide a revenue stream at the local level and may be established on a regional (e.g., watershed) basis. A full discussion on the potential use of stormwater utilities in Connecticut has been provided as part of Technical Memorandum 2.

#### 5.1.1.3.1 Stormwater Utility Subcommittee

Implementation of stormwater utility districts in Connecticut will necessitate development of significant new policy, programs, and administrative structures. To make new policy, programs, and administrative structures efficient and service oriented, proponents from different levels of government and interested municipalities may wish to meet in a subcommittee to identify opportunities to cooperate in developing common approaches.

#### 5.1.1.3.2 Guidance Document

Prior to pursuing stormwater utility districts at any governmental level, an approach to fee-setting and bureaucratic structure should be considered. It may be helpful to develop a model stormwater utility district ordinance and guidance manual for utility district development and implementation in Connecticut. To ensure usefulness, guidance materials should be vetted through a test group of likely users of the guidance document. A subcommittee, such as the one described in *Section 5.1.1.3.1*, would make a good test group.

#### 5.1.1.3.3 Technical and Financial Assistance Program

Starting new programs, such as stormwater utility districts, creates a draw on resources and requires development of technical expertise at the point of implementation. This is typically made easier with technical and financial assistance from an oversight organization or agency. An assistance program could be established for entities interested in developing or enhancing stormwater utility districts. If a stormwater utility subcommittee is developed (see *Section*



5.1.1.3.1), the technical and financial assistance program could be developed in consultation with the subcommittee to ensure a comprehensive input.

#### 5.1.1.3.4 Public Outreach and Awareness Toolbox

Research on stormwater utility districts around the country shows that public awareness and support are critical issues in establishing successful stormwater utility districts. How will municipalities know if they have the level of public acceptance necessary to establish a stormwater utility district? What is the most effective way to educate the general public about the nature and benefits of stormwater utility districts? A program of public education and outreach could be designed and developed to assist local governments in developing stormwater utility districts. If a stormwater utility subcommittee is developed (see *Section 5.1.1.3.1*), the public outreach and awareness toolbox could be developed in consultation with the subcommittee to ensure a comprehensive input.

#### 5.1.1.3.5 Delegation of Regulatory Authority

In Connecticut, permitting related to stormwater management for land-use development occurs at both local and state government levels. However, multiagency permitting can create unintentional conflict and local governments may feel constrained to adhere strictly to state decision making. Because stormwater utility districts can provide a greater and more consistent level of resources than general taxation (the typical source of stormwater management funding at the municipal level), a utility district may make full stormwater permitting and management possible on the local level. This may make it practicable for DEP to delegate state permitting authority to local agents.

#### 5.1.1.4 Hybrid Option

A “hybrid” approach (i.e., combination of alternatives) was suggested in the carousel activity as part of Workshop 2. A hybrid option could involve parallel initiatives to:

- Revise the *Connecticut Stormwater Quality Manual* and *Connecticut Soil Erosion Sediment Control Guidelines* to include LID.
- Update the SGP with a variety of new LID policy.
- Build a nonregulatory support system for LID implementation.
- Enable and encourage stormwater utility districts.

To maximize the benefits and allow flexibility, the state could institute a multitrack permitting process. Such an approach could be implemented at either the state or local level through delegation of authority. Many possible multitrack configurations exist and a specific approach may be somewhat difficult to envision. To illustrate the general idea of a hybrid option, one hypothetical example for the construction general permit, which combines designer licensing, cap and trade, specific performance standards for LID, and adjusted standards for TMDLs, is presented below.



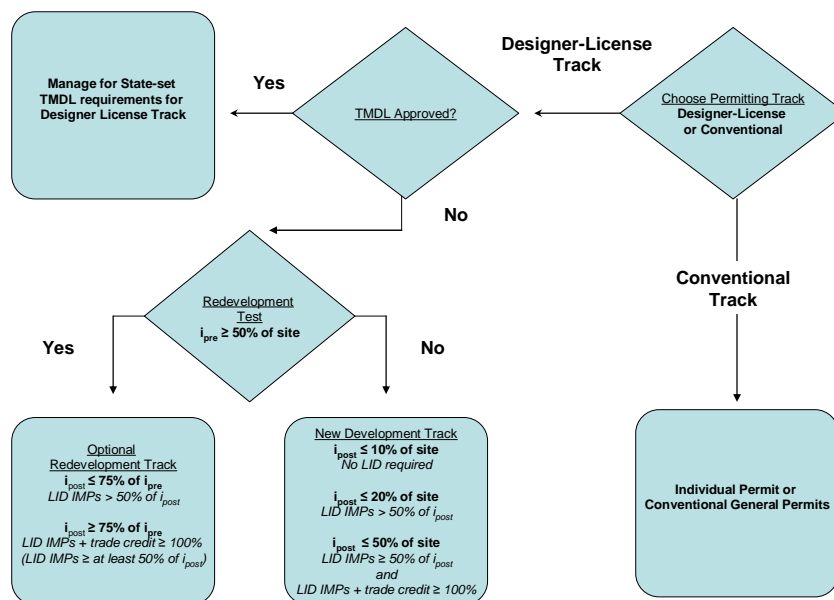

Figure 5.1—Flow diagram of a hypothetical hybrid option including designer licensing, special requirements for TMDLs, redevelopment standards, and graduated permitting standards.

This hypothetical approach includes the following features:

- Applicants may choose to use conventional approaches such as an individual permit or other general permit.
- Applicant’s plans and notices of intent must be signed and stamped by a designer with a designer license.
- DEP may establish special LID requirements in TMDLs for the designer license track.
- Designer licensing is used for both new development and redevelopment. A threshold of the pre-existing impervious surface ( $i_{pre}$ ) is used to test for whether a site is considered a development or redevelopment site. For the purpose of example, this threshold is set at 50 percent. To use the redevelopment general permit, applicants must take one of two approaches:
  - Removal of 25% of preexisting impervious surface and 50% of the post-development impervious surface ( $i_{post}$ ) must be managed with LID IMPs; or
  - Manage at least 50% of the impervious surface with LID IMPs and manage the remaining 50% with IMPs and LID trading credits.
  - A hypothetical set of impervious surface limits is used to set graduated requirements for the new development track:
  - Sites developed at less than 10% impervious are not required to use LID. This does not preclude the use of LID. Ten percent was selected because

- national studies show that development of watersheds at less than 10% impervious creates no measureable deleterious effect on water quality.
- For sites newly developed at up to 20% impervious, at least 50% of post-development impervious surface must be managed with LID.
  - For sites newly developed at up to 50% impervious, LID IMPs must be used onsite to manage at least 50% of post-development impervious surface and the remaining impervious surface must be managed with either LID on site or through trading LID management of impervious surface from another site.

While a multitrack process improves flexibility and allows for graduated standards, it adds complexity to the process. Partners should consider whether the benefits of flexibility outweigh potential issues associated with a more complex approach.

### 5.1.2 Incorporating LID Performance Goals and Criteria in General Permits

Performance goals could be incorporated into general permits in a wide variety of ways. There is really no single correct or ideal way to do this. Thus the actual method selected will ultimately be a matter of best judgment and stakeholder preference. Thus far in this project, research on methods of incorporating LID performance goals and criteria in general permits has followed a three-pronged approach:

- Partner interviews
- Web research and interviews to determine approaches used by other states
- Interactive workshop activities

The process of making this selection should also reflect the approach chosen to incorporate LID standards into state stormwater policy. As the LID incorporation approach is yet to be determined, the precise method to incorporate performance is also undecided. Therefore, the remainder of this section provides our findings to date.

#### 5.1.2.1 Partner Interviews

As a first step to determine preference, Partners were asked for their ideas as part of telephone interviews. The interview process is described in *Section 3.2.2.1* of this report. During each interview with Partners, the following questions were asked:

*How do you think they [LID practices] should be incorporated into DEP policy?*

- d. By reference to a document*
- e. Specific standards*
  - v. Narrative standard*
  - vi. Prescriptive design standard*
  - vii. Numeric standard*
  - viii. Performance standard*
- f. Other methods*

Responses provided no clear consensus on an implementation approach. In fact, many respondents specifically stated that they were unsure, unqualified to answer, or needed to give the matter further consideration; however, generally speaking, interviewees that provided a specific response seemed to be calling for flexibility by indicating preference for guidance (26% of respondents) and performance standards (26%). Responses were essentially split on whether or not to regulate, with no regulation being preferred by five respondents and regulation being preferred by six respondents.

### **5.1.2.2 Approaches Used by Other States**

A desire to establish clear standards and maintain flexibility appears to be common in other states, as most states that include LID in regulation have established hybrid approaches that involve flexible regulation, guidance and performance standards. Findings from state reviews indicate other regulatory agencies use one or a combination of these methods.

- A LID manual established as guidance only. In Connecticut, a LID stormwater document could lay out a LID process as well as discuss BMPs and performance criteria for implementation. SGPs could reference the LID manual as a guidance document.
- As an alternative to the bullet above, Connecticut could develop a LID manual but opt to not reference it in the SGPs.
- Incorporate LID directly into SGPs or into regulation or policy. Performance goals and criteria could be established in the SGPs or regulation. Flexibility could be incorporated into this method by either requiring or encouraging LID. Several states have taken similar approaches in combination with a design manual.

### **5.1.2.3 Findings from Interactive Workshop Activities**

Two workshops with Partners have been held to date. Activities in these workshops have included card storming and a carousel activity. These activities are fully described in the Workshop 1 and Workshop 2 meeting summaries. Through workshop activities, Partners have indicated that the standard should be a uniform, statewide policy that is adopted at both the state and local levels and that standards implemented should translate across multiple permitting programs. Additional features of such policy should include:

- Water quality standards.
- Soil erosion standards.
- Groundwater recharge standards.
- Runoff reduction standards.
- Impervious reduction standards.
- Maintenance requirements.
- Process for verifying effectiveness.
- Process for considering innovation.

### 5.1.3 Methods for Giving LID Priority in Stormwater General Permits

In interviews conducted with Partners,<sup>7</sup> most interviewees (18 of 27) expressed a desire to include LID as BMPs of choice versus end-of-pipe BMPs. A number of respondents pointed out that such a requirement should include flexibility to address situational issues.

Standards used by other states<sup>8</sup> to establish priority LID over end-of-pipe controls include:

- Requiring that a percentage of runoff volume is managed using LID.
- Requiring set-aside of an area of a site for LID (e.g., Using a related approach, Wisconsin requires set-aside of 1 - 2% of each development site for infiltration).

Impervious surface reduction could be required at redevelopment sites to reduce the need for end-of-pipe BMPs. This approach is currently being used in several other states. The standards could be written to address other situational issues such as soil type and specific water quality concerns.

Two basic approaches have been identified to incorporate LID priority into the general permits:

- One or more specific standards requiring LID, such as the two discussed above, could be written into the SGPs.
- Specific standards or a LID design process could be written into the Connecticut Stormwater Manual or a supporting document. The Connecticut Stormwater Manual or supporting document could then be referenced in the SGPs as a required design standard.

These alternatives imply a tradeoff. If LID-priority standards are written into the SGP, the standards are clearly established for the regulated community. Referencing the Connecticut Stormwater Manual creates an indirect standard, which is by its nature somewhat less clearly anchored in policy. On the other hand, a LID-priority standard, which is written into the SGP,

---

<sup>7</sup> Refer to Summary 1 and Technical Memorandum 1 for further discussion of the interviews with Partners.

<sup>8</sup> Refer to Summary 2 and Technical Memorandum 1 for further discussion of standards used by other states.

will need to be fairly concise. LID, however, is a process-oriented approach, which is generally better suited to the flexibility of a guidance manual.

---

## 5.2 Rationale for Selection of Alternatives

In part, this project has been designed to result in Partner identification of five or more alternatives to incorporate LID into the Connecticut SGP and then selection of alternatives, using a rational process, for further development. To date research, interactive workshops, and interviews with Partners have resulted in the identification of a number of alternatives grouped into three general implementation approaches; a set of six selection criteria; and a list of strengths, benefits, weaknesses, and dangers of each of the three general implementation approaches. This section of the report compiles this information and discusses the approach used in the selection of alternatives for further development and consideration.

### 5.2.1 Candidate Alternatives for Selection

Alternatives are listed below categorized into groups by type of implementation approach. Each of the alternatives is described above in *Section 5.1.1* of this summary document.

- Regulatory
  - Update the Manual/Guidelines
    - Standalone LID update
    - Appendix to the Manual/Guidelines
    - Direct incorporation into the SGP
  - Incorporating Standards into the SGP
    - Reference the Manual/Guidelines in the SGP as requirement
    - Reference the Manual/Guidelines in the SGP as guidance
    - Write specific standards from the Manual/Guidelines into the SGP
  - Designer licensing
  - Impervious surface cap and trade
  - Adjusted standards for areas of special concern
- Nonregulatory
  - Training program
  - Financial incentives
  - Technical assistance
  - Public education
- Stormwater Utility Districts
  - Stormwater Utility Subcommittee
  - Guidance document
  - Technical and financial assistance program
  - Public outreach and awareness toolbox
  - Delegation of regulatory authority

- Hybrid Option

### 5.2.2 Selection Criteria

The six selection criteria were adapted from a card storming exercise conducted in workshops 1 and 2. The full results of this process are provided in Technical Memorandum 1. Generally, this exercise indicates that the implementation approach should be:

- Economically Viable—Meaning cost effective and sensitive to market demand.
- Knowledge-Based—Meaning based on good science, implemented by knowledgeable people, acceptable to the public, and focused on behavior change.
- Clear and Understandable—Meaning simple and uniform statewide approach that is easy to administer and enforce at the local level.
- Practicable and Flexible—Meaning not burdensome to comply with, sensitive to site constraints and project type, leaving room for innovation and being performance based.
- Administrable—Meaning compatible with other state regulations, allowing for alignment of municipal policy with state LID policy, supportive of contractors and homeowners, enforceable, measurable, certain, and strict.
- Environmentally Beneficial—Meaning focused on impervious surface reduction, soils, water quality and quantity, groundwater recharge, fixing impairments and conservation.

### 5.2.3 Comparing Candidate Alternatives Using Selection Criteria and Data from Workshop 2

During Workshop 2, Partners participated in a carousel activity that was used to explore the strengths, benefits, weaknesses, and dangers of implementation approaches. A full description of this workshop is provided in Workshop 2 Summary (see *Appendix D*). The table below aligns the results of the carousel workshop with the criteria identified through card storming and presented in *Section 5.2.2* (above). This tabular summary allows for the comparison of the advantages and disadvantages of the three general types of implementation approaches; however, the hybrid alternative is not included as it is yet to be defined.

**Table 5.1  
Summary of General Alternatives and Criteria for Decision Making**

Type of Approach	Economically Viable	Knowledge-Based, Behavioral Change	Clear and Understandable	Practicable and Flexible	Administrable	Environmentally Beneficial	Other
<b>Regulatory</b>		<u>Strengths</u> Experience People know... Mandatory	<u>Strengths</u> Clarity/uniformity		<u>Strengths</u> No free rider/fairness Helps municipalities justify		
	<u>Benefits</u> Avoids externalizing costs	<u>Benefits</u> Will get LID implemented Ensures most use of LID	<u>Benefits</u> Transparency Consistent standard		<u>Benefits</u> Quick goal attainment	<u>Benefits</u> Public health-flood mitigation Fixes biggest problems	
	<u>Weaknesses</u> Bureaucracy/cost Not market viable	<u>Weakness</u> Lack of experience	<u>Weaknesses</u> Difficult to be uniform	<u>Weakness</u> Mandatory Flexibility of industry/towns Compliance at local level Problem to implement at existing facilities Bureaucracy	<u>Weaknesses</u> Enforcement (staff) Municipal ability to implement		
		<u>Dangers</u> Municipal knowledge Applicant knowledge	<u>Dangers</u> State/municipal conflict	<u>Dangers</u> Not enough flexibility Carved into marble Hard to modify flaws Not applicable on every site	<u>Dangers</u> Limited enforcement State/municipal conflict Municipal ability to implement		
<b>Nonregulatory</b>	<u>Strengths</u> Financial benefit for small contractor/operator	<u>Strengths</u> Behavior change Politically palatable Educates the public and encourages voluntary buy-in Larger buy-in across the board		<u>Strengths</u> Keeps options open Flexible			
	<u>Benefits</u> Economic development	<u>Benefits</u> Training and education		<u>Benefits</u> Experimentation Demonstration projects		<u>Benefits</u> ...Environmental benefits will follow	<u>Benefits</u> Variable funding sources
		<u>Weakness</u> Might not be a priority	<u>Weakness</u> People have a choice to opt out Uncertainty for local boards and commissions No consistent application of LID	<u>Weaknesses</u> Nonmeasureable/predictable	<u>Weaknesses</u> May not be implementable (staff and resources) Funding may be difficult Provides no incentive for meeting regulatory		





Type of Approach	Economically Viable	Knowledge-Based, Behavioral Change	Clear and Understandable	Practicable and Flexible	Administrable	Environmentally Beneficial	Other
					requirements Fails to comply with CWA At odds with current regulations		
		<u>Dangers</u> Political process Becomes a low priority	<u>Dangers</u> Consistency Free-rider	<u>Dangers</u> Status quo	<u>Dangers</u> Need incentives for developers		
<b>Stormwater Utility Districts</b>			<u>Strengths</u> Local authority and control		<u>Strengths</u> Piggyback on existing regional groups (e.g., water and sewer authorities like MDC) Removes stormwater from politics	<u>Strengths</u> Watershed based	<u>Strengths</u> Regional Partnerships
		<u>Benefits</u> Education Taxpayer expectations	<u>Benefits</u> Local authority and control	<u>Benefits</u> Could adapt to local geographical conditions	<u>Benefits</u> Dedicated funding stream Accountability Raises revenues, funds	<u>Benefits</u> Reduction of impervious cover Comprehensive approach to water management; interrelationship	<u>Benefits</u> Businesses/owners working together
	<u>Weaknesses</u> Cost to towns Cost to regulated community Existing IC may have disproportionate cost	<u>Weaknesses</u> Political will to accept regionalization Removes public input			<u>Weaknesses</u> Legal framework How to measure success? Regional/town conflicts		
		<u>Dangers</u> Political conflicts Public perception "tax" CT legislature won't add new tax	<u>Dangers</u> Voluntary or required that every town have/join one?		<u>Dangers</u> Overlapping authorities need to coordinate Who sets the fee and how?		



## 5.3 Selection of Alternatives in Cooperation with the Partners

With implementation alternatives, selection criteria, and strengths, benefits, weaknesses and dangers identified, it is possible to compare alternatives, make adjustments to alternatives so that they better address the selection criteria, select an appropriate alternative or set of alternatives for implementation, and plan a course of action. As this project is designed to conduct selection of alternatives in cooperation with the Partners, Workshop 3 was used as a vehicle for the selection process. The selection process involved three steps:

- Preparation for Workshop 3
- Exploring Alternatives—Café Workshop
- Identifying Preferred Alternatives Based on Criteria—Dot Voting Using a Criteria Matrix

### 5.3.1 Preparation for Workshop 3

In advance of Workshop 3, Partners were provided with *Summary 4: Rationale for Selection of Two Alternative Scenarios for Implementation*, which included a summary of alternatives (see *Section 5.1* of this report) and a rationale for selection of alternatives (see *Section 5.2* of this report), and were asked to consider the following questions:

- Is there a single alternative or general alternative type that can clearly meet all the selection criteria?
- Is there a combination of alternatives that could be used to clearly meet all the selection criteria?
- Are there adjustments that could be made to the proposed alternatives to make them more effectively meet the selection criteria?
- Are there alternatives that have yet to be considered that could better address the selection criteria?

Partners were also asked to consider the form that LID standards should take relative to the *Stormwater Quality Manual* and *Soil Erosion and Sediment Control Guidelines* as well as the SGP. Current alternatives include:

- Manual/Guidelines
  - Standalone LID documents.
  - Appendix to the Manual/Guidelines.
  - Full update of the Manual/Guidelines.
- SGP
  - Reference to the Manual/Guidelines in the SGP as a requirement.
  - Reference to the Manual/Guidelines in the SGP as a guidance document.

- A specific written standard in the SGP.

### 5.3.2 Exploring Alternatives—Café Workshop

A café workshop is an effective vehicle for opening up conversations and discussions as it allows people to engage each other in dialogue with the aim of learning from each other rather than debating. During Workshop 3 (August 31, 2010), Partners were asked to participate in a café workshop.

The purpose of the café workshop was introduced at the outset of Workshop 3 as follows:

- Examine ideas about how alternatives work together
- Have an open dialog about alternatives
- Leverage collective knowledge
- Elicit innovation and good decision making



**Photograph 5.1**—Café workshop in process.

Specifically, the café workshop involved the following steps:

- Split into groups (about 4 to 6 people per group) and pick a “reporter.”
- Open café i.e., discussion about alternatives.
- Document results.
- Reporter presents findings and notes any new alternatives.

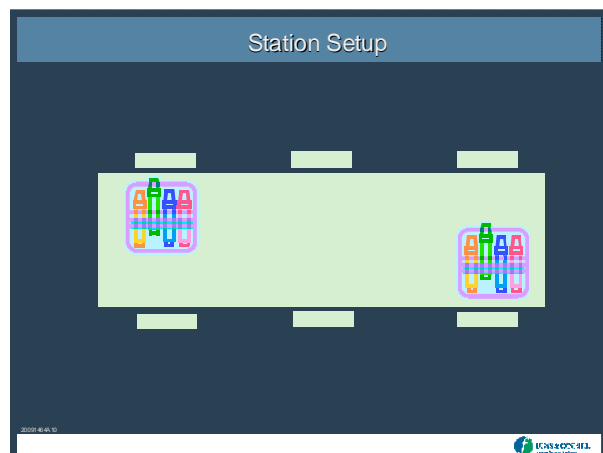

**Figure 5.2**—Café station set-up.

Setup of each café workshop station (i.e., table) is diagramed in *Figure 5.2* (right) and included multicolor markers, a paper “table cloth” for brainstorming and documentation, six seats, and copies of Summary 4 for participant reference.

At the end of the café workshop, reporters reported results by group.<sup>9</sup> The written results from each group are provided in *Appendix E*.

<sup>9</sup> Groups were not actually named or numbered during the exercise. Group numbers are provided in this summary for the sole purpose of differentiating the reports from each group.

In a café workshop, the primary purpose is to examine ideas with other stakeholders and gain and understanding of their perspective. Specific findings from each group are less important than the collaborative process and sharing of ideas. New ideas often arise through this process; and in the case of the August 31 café workshop, two new alternatives for implementation of LID were brought forward:

- Development of a LID certification or award process, analogous to the Leadership in Energy and Environmental Design.
- Development of a municipal LID certification or award process.

### 5.3.3 Identifying Preferred Alternatives Based on Criteria—Dot Voting Using a Criteria Matrix

Dot-voting is a method for establishing agreement on alternatives among a large number of people. Participants “vote” on alternatives using a specified number of dot stickers. As part of Workshop 3, following the café workshop, Partners were asked to participate in a dot-voting exercise. The approach used dot-voting in combination with a criteria matrix. A criteria matrix allows for evaluation of alternatives based on specific predetermined criteria. The matrix dot-voting approach makes it possible to for a group to select preferred alternatives and identify why they selected them.

The purpose of the dot-voting workshop was described prior to the exercise as follows:

- Identify alternatives for immediate development
- Determine how alternatives compare with criteria
- Determine how alternatives fit best together when considering criteria

The dot-voting workshop included the following steps:

- Participants were each given 15 dots.



**Table 5.2  
Results of Dot-Voting**

Type of Alternative	Alternative	Economically Viable	Knowledge-Based, Behavioral Change	Clear And Understandable	Practicable And Flexible	Administrable	Environmentally Beneficial	
Regulatory	Update the Manual/Guidelines Incorporating Standards into the SGP							
	Designer licensing	3	9		1	4		17
	Impervious surface cap and trade						2	2
	Adjusted standards for areas of special concern	6	3		14	3	5	31
	Training program	4	11	7	5	2	6	35
Nonregulatory	Financial incentives	18			2		6	26
	Technical assistance	6	2	2	17	2	8	37
	Public education	4	15	10	2		4	35
	Stormwater Utility Subcommittee	15	1				6	22
Stormwater Utility	Guidance document	1	3	14	3	2	8	31
	Technical and financial assistance program	6	4			2	6	18
	Public outreach and awareness toolbox	2	9	6	7		2	26
	Delegation of regulatory authority	1			4	1		6
	LID Cert./Award	3	8		2	2		15
New Alternatives as of Workshop 3	Municipal Cert.	3	11	4			1	19
		72	76	43	57	18	54	

Notes:

- The five alternatives receiving the most votes overall are shown in pale blue. The two highest scoring alternatives for any specific criteria are shown in violet.

### 5.3.4 Observations from the Dot-Voting and Previous Exercises

The following are observations from the dot-voting process:

- Nonregulatory alternatives (e.g., training, technical assistance, and public education) tended to receive more votes than alternatives in the regulatory or stormwater utility categories. This would indicate that the Partners as a group desire to see training early in the LID implementation process.
- Alternatives with one or more of the two highest vote tallies under a criterion (violet cells) are generally one of the five alternatives with the highest total number of votes (pale blue cells). This indicates that Connecticut can probably achieve a relatively balanced LID implementation approach by working on the alternatives receiving the most total votes. For example, if Connecticut implements a nonregulatory LID program that includes a combination of training, technical assistance, and public education, the top-three rated alternatives would be addressed and the top vote getters for the criteria “knowledge-based, behavior change,” “practicable and flexible,” and “environmentally beneficial” would also be included.
- Based on “Table 1 Summary of General Alternatives and Criteria for Decision Making,” the strengths, benefits, weaknesses, and dangers associated with nonregulatory programs make a nice compliment to regulatory programs. That is to say, regulatory alternatives are viewed as having strengths under the criteria of “clear and understandable,” “administrable,” and “environmentally beneficial”; while nonregulatory alternatives were viewed as having strengths and benefits under the criteria of “economically viable” and “practicable and flexible.” A combination of regulatory and nonregulatory alternatives; therefore, provides strengths and benefits under the criteria of “clear and understandable,” “administrable,” “environmentally beneficial,” “economically viable,” and “practicable and flexible.”
- The “training” alternatives within the nonregulatory alternatives scored highly under “knowledge-based, behavioral change” and “clear and understandable”; while public education scored highly under “clear and understandable”; and “technical assistance” scored highly under “practicable and flexible.” If the partners decide to pursue nonregulatory alternatives, a combination of these three alternatives would probably provide the most balanced approach.
- The only alternatives that scored well for “economically viable” were the “stormwater utility subcommittee” and “financial incentives.” Including one or more of these alternatives, even though they did not score well overall, may help to provide a more rounded approach to LID implementation.
- Development of a stormwater utility “guidance document” was one of the five top-rated alternatives. Development of stormwater utility enabling legislation would probably be necessary to make the stormwater utility guidance document meaningful.



- Although the “LID certificate/award” and “municipal certificates” were not among the top total vote getters, they are also newly developed alternatives and have yet to be fully vetted. Municipal certificate received the second highest score under the “knowledge-based, behavior change” criterion.
- If desired, “adjusted standards for areas of special concern” could probably be incorporated with the “update of the manual/guidelines” and/or “incorporating standards into the SGP.” DEP has decided to pursue both of these alternatives as part of this project.
- The two alternatives receiving the fewest votes were “impervious surface cap and trade” and “delegation of regulatory authority.” These alternatives should probably be set aside.
- The criteria of “administrable” and “environmentally beneficial” received the fewest total votes. “Administrable” received the lowest number with 18 total votes. This does not necessarily mean that the alternatives available are neither readily administrable nor particularly environmentally beneficial; however, exploring this issue might be instructive.

## 6 Incorporating LID into Connecticut Guidance Manuals

This section provides a discussion of LID standards and process for planning LID projects. These standards are intended to form the basis of information to be incorporated into the *Stormwater Quality Manual* and the *Soil Erosion and Sediment Control Guidelines* as well as to update the SGP. The update could take one of three forms:

- Standalone document that focuses on the LID process and LID standards.
- Appendix to the existing *Stormwater Quality Manual* and *Soil Erosion and Sediment Control Guideline*.
- Full update to the *Stormwater Quality Manual* and *Soil Erosion and Sediment Control Guideline*.

In general, the advantage of a standalone document or an appendix is that either can be developed fairly quickly and with a pure focus on LID. Updates of both the manual and guidelines will necessitate a more involved process of fitting LID into the structure of the existing documents. This will take substantially longer.

Partner Workshop 4 was used to solicit recommendations on a methodology that developers and regulators can use to assess impact of projects and determine whether permit limits will be met. General consensus was reached on a two-step approach to standardizing LID:

- Step 1—Develop an LID guidance for inclusion as an appendix to the existing *Stormwater Quality Manual* and *Soil Erosion and Sediment Control Guideline*.

- Step 2—Develop a Full update to the *Stormwater Quality Manual* and *Soil Erosion and Sediment Control Guideline*.

Step 1 (i.e., the appendix) is being planned to initiate in the winter of 2011. Step 2 will be planned subsequently, but at a time as yet to be determined.

Local agencies sometimes adopt or reference the *Stormwater Quality Manual* and *Soil Erosion and Sediment Control Guideline* as policy or standards documents. In some instances, local policy may include code and standards that conflict with LID. *Section 6.5* presents a series of questions to assist local government agencies in identifying common policy conflicts between local development policy and LID.

The remainder of this section includes discussion on the following topics:

- Introduction to Low Impact Development
- LID Planning and Design Process
- Design Standards for Low Impact Development Controls
- Overcoming Impediments to Low Impact Development at the local level

Potential approaches for incorporating LID into Connecticut guidance is also provided in text boxes. The text boxes are intended to call attention to alternative approaches without interrupting the reader's train of thought. Such discussion makes note where existing Connecticut guidance (*Connecticut Guidelines for Soil Erosion and Sediment Control* and *Connecticut Stormwater Quality Manual*) provides standards or other discussion of LID controls or closely related controls and how it might be updated.

---

## 6.1 Introduction to Low Impact Development

Traditionally, stormwater has been managed using large, structural practices installed at the low end of development sites—essentially as an afterthought—on land segments left over after subdividing property. This approach, sometimes referred to as end-of-pipe management, yields the apparent advantages of centralizing control and limiting expenditure of land. Unfortunately, end of pipe technology has been shown to have many economic and environmental limitations such as failure to meet receiving water protection goals, high construction, operation and maintenance costs, certain health and safety risks and limited use for urban retrofit. In response to these deficiencies an alternative technological approach has emerged that is generally more economical and potentially provides far better environmental protection. This new approach is referred to as LID.

In contrast to conventional centralized end-of-pipe management, LID uses numerous site design principles and small-scale treatment practices distributed throughout a site to manage runoff volume and water quality at the source. For new development, LID uses a planning process to employ site design techniques to first optimize conservation of natural hydrologic functions to prevent runoff. If these conservation practices are insufficient to meet required

stormwater goals then engineered at the source treatment practices are used to meet volume and water quality objectives.

LID's distributed techniques provide retention, detention and filtration of runoff in a manner that more closely mimics the natural water balance (interception, interflow, infiltration and evapotranspiration). This is accomplished through the cumulative effects of using an array of runoff reduction techniques, small scale nonstructural or engineered practices to treat runoff. Further the uniform distribution of controls throughout a site increases runoff time of travel and concentration dramatically reducing discharge flows and increasing opportunities for infiltration and filtration within landscape features.

With appropriate selection, application and design, LID principles and practices can be used in any land planning type, soils, climate or hydrologic regime. For example, in soils with high infiltration rates LID practices may heavily rely on infiltration. For high density urban or retrofit development infiltration may not be desirable or possible; therefore, filtration, detention and runoff capture-and-use practices would be more applicable. In cold climate filtration-infiltration practices must be designed to minimize freezing allowing treatment when needed. LID principles and practices are highly adaptable and can be customized for any development scenario or receiving water goal.

The creation of LID's wide array of small-scale management principles and practices has led to the development of new tools to retrofit existing urban development. Small-scale practices can be easily integrated into existing green space, streetscapes and parking lots as part of the redevelopment process or through routine maintenance and repair of urban infrastructure. As urban areas redeveloped with integrated LID techniques, over time it will be possible to dramatically reduce pollutant loads to receiving waters to restore impaired waters.

However, the use of LID practices does not necessarily supplant the need for end-of-pipe technology. Hybrid approaches, which incorporate both types of practices, may be needed to meet stringent water quality and flood control requirements. However, as LID's decentralized practices can better reduce adverse environmental impact, Connecticut regulatory agencies will typically expect permit applicants first carefully consider all opportunities to use such practices prior to exploring end-of-pipe management. The use LID techniques alone or in combination with conventional techniques will not only reduce adverse water quality impact, but will help to restore vital ecological processes necessary to restore or sustain the ecological integrity and quality of our water resources.

LID represents an alternative approach to controlling stormwater runoff that provides effective new tools to restore or maintain a watershed's hydrologic functions for both new and existing development. LID is still relatively new and rapidly evolving stormwater management technology. It was first described in 1999 in the Prince George's County, Maryland, *Low-Impact Development Design Strategies: An Integrated Design Approach*. However, today due to LID's many economic and environmental advantages over conventional end-of-pipe technology, it has been widely and rapidly adopted throughout the country. This LID design guidance has been developed using the latest information and past lessons learned to provide the most up to date design guidance.

LID uses many decentralized small-scale management practices strategically located throughout a development to conserve and engineer the urban landscape in a manner that mimics predevelopment hydrologic conditions. Ideally, these LID practices are seamless in the developed environment as all traditional site features are designed to be multifunctional. Residential, commercial, and industrial properties look the same but the landscape features are designed to provide water quality and hydrologic functions to storage, detain, filter, and infiltrate runoff. Typical advantages of LID's integrated approach over the conventional end-of-pipe approach include:

- Reduced consumption of land for stormwater management – LID practices provide opportunities to integrated controls into all aspects of a site's hardscape and landscape features. This allows multifunctional use of the entire developed site for controls allowing the most cost effective use of land. Less land is needed or consumed for end-of-pipe controls often allowing for more developable space.
- LID does not dictate particular land-use controls – Since LID is a technological approach there is no need to change conventional zoning or subdivision codes accept to allow LID's use. This means LID does not reduce development potential and with less land consumed for stormwater controls lot yields may increase.
- Reduced construction costs – Traditional stormwater management requires significant storm sewer and earthwork. LID practices apply controls as close to sources of runoff as possible. Wherever practicable, conveyances incorporate natural flow paths and swales instead of pipes. Structures installed are small, thus reducing the need for excavation and construction materials.
- Ease of maintenance – LID landscape practices require limited maintenance or no increase in maintenance beyond typical landscape care. Much of the maintenance required can be accomplished by the average landowner. Further many LID site planning, conservation, and grading techniques require no maintenance.
- Takes advantage of site hydrology – Conservation of natural resources, topography, land cover, soils, and drainage features preserve the natural hydrologic functions allowing absorption of runoff from impervious surfaces. Runoff that is absorbed recharges groundwater and stream base flow and does not need to be managed or controlled by an end-of-pipe practice. Preserving and maintaining the natural hydrology also better protects streambank stability and riparian habitat.
- Better quality of discharge – Recent research indicates conventional end-of-pipe controls are unable reduce pollutant concentrations below certain thresholds, which may exceed water quality standards. However, LID techniques have shown to be far more effective in reducing the annual pollutant loads through both volume reduction and filtration of runoff. Use of natural landscape features and use of lot-level bioretention and swales may, in many cases, allow for retention all runoff from events smaller than the 2-year, 24-hour storm and significantly reduce peak discharges from larger storms.

- More aesthetically pleasing development – Traditional stormwater management tends to incorporate the use of large, unnatural looking practices such as detention ponds. When neglected, these practices may present drowning and mosquito breeding hazards. Nonstructural and upland practices optimize use of landscape features that are more aesthetically pleasing and fit well into the natural landscape.
- Multiple benefits – LID has shown to provide multiple benefits such as reducing energy cost by using green roofs and proper location of trees for shading and water conservation by using rain water as a supplemental water supply.
- Urban retrofit tool – LID is ideal for urban retrofit and redevelopment. Integrating LID small-scale practices into every urban landscape feature over time will reverse adverse water quality impacts of existing urban areas.
- Improved profit margin – The advantages of nonstructural and upland management translate into the marketplace. The value added is significant. Several studies indicate that the cost of applying these nonstructural and upland stormwater management techniques is about half that of the traditional approach. The results of one example of such a study are summarized in *Table 6.1* below (Schuler, 2000). Properties developed using nonstructural and upland stormwater practices tend to command higher sale prices.

**Table 6.1  
Cost Analysis for Conventional and Alternative Development**

<b>Cost Categories</b>	<b>Conventional Development</b>	<b>Alternative Development<sup>a</sup></b>
Engineering	\$79,600	\$39,800
Road Construction	(20,250 linear ft.) \$1,012,500	(9,750 linear ft.) \$487,500
Sewer and Water	\$25,200	\$13,200
Other Costs	\$111,730	\$54,050
<b>Total</b>	<b>\$1,229,030</b>	<b>\$594,550</b>

Source: Center for Watershed Protection, 2000, *The Practice of Watershed Protection*, page 175.

Notes:

<sup>a</sup>Alternative development cost analysis was done for cluster development, which is similar to conservation development.

## 6.2 LID Planning and Design Process

LID represents a new philosophy in stormwater management. Runoff is viewed as a resource and hydrology used as an organizing principle for site design. Learning how to work with rain water in the landscape rather than just quickly disposing of it. LID is an ecologically friendly approach to site development and stormwater management that aims not just to minimize development impacts (reduce impervious surfaces), but instead restore vital watershed



ecological processes (natural hydrologic regime) necessary to restore and maintain the physical and biological integrity of waters and the quality of life.

LID uses new management principles such as conservation of soils and drainage patterns; using integrated decentralized controls; uniform distribution of lot-level controls to increase runoff storage, contact time and time of travel; and, multifunction landscape features engineered to make the most cost effective use of space. The landscape is comprehensively engineered and optimized for stormwater controls. All of these principles are in direct contrast to conventional end-of-pipe treatment. *Figure 6.2.1* and *Figure 6.2.2* contrasts conventional centralized controls with a LID decentralized approach.

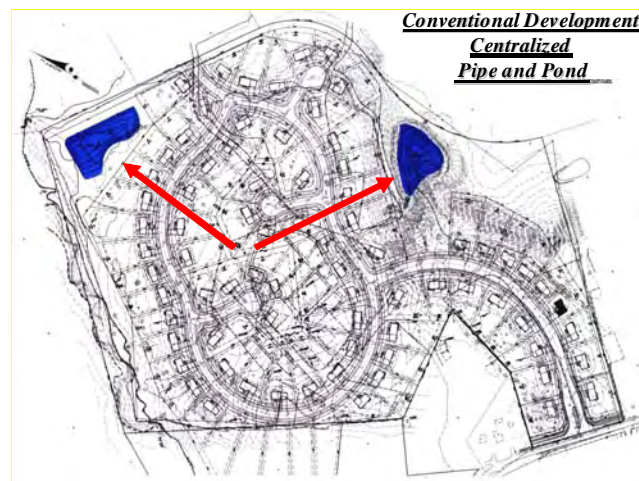

**Figure 6.2.1 – Conventional Controls.** A conventional approach requires clear cutting, mass grading and use impervious surfaces, gutters pipes and ponds to collect and treat runoff. This approach completely alters and destroys the natural hydrology and ability of the landscape to absorb rainwater and capture pollutants.

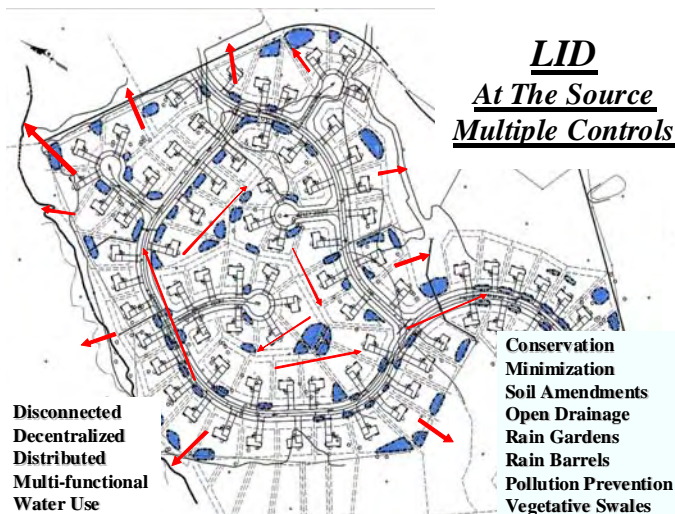

**Figure 6.2.2 – LID Controls.** A LID approach use a wide array of techniques that work with the landscape, soils, drainage patterns and vegetation to minimize impacts and integrated management controls to retain, detain, infiltrate and filter runoff. LID can provide better stormwater controls by mimicking the pre-development hydrology. Often LID designs increase lot yield and reduce infrastructure cost.

To optimize the benefits of LID, there is also a specific site planning and design process to follow. This process includes optimizing conservation at the larger project level; minimize impacts at site level, maintaining drainage features and use of engineered integrated management practices. The principles and design processes are explained in more detail below.

## 6.2.1 Basic Planning Principles

A well-designed integrated stormwater management system will minimize the volume of runoff generated and maximize the treatment capabilities of the landscape. A LID design controls runoff as close to the source as possible. A well-designed system should also be easy to maintain, not interfere with the typical use of the property, and be aesthetically pleasing. To optimize a LID design, it is important to consider a number of site planning principles and follow a systematic design processes from the very beginning. Each site has a unique set of characteristics and will require the use of a unique blend of site specific LID planning and treatment techniques.

Another important factor in LID design is that it is best applied by a multidisciplinary team of professionals. The contributions of soils scientist, biologist, landscape architects, urban planners, and engineers are all equally important. It is not just about meeting the volume storage and flow regulatory requirements, it is about professionals using their combined knowledge and skills to create and design the most ecologically functional, economically viable, aesthetically pleasing livable community possible.

Several basic LID planning principles should remain in the forefront throughout the various steps of the site planning and design process. These principles require a completely different way of thinking about site design than current convention.

For example, an important LID concept is to keep water on the site as long as possible using the landscape to treat runoff, but without causing flooding problems or interfering with the typical use of the property.

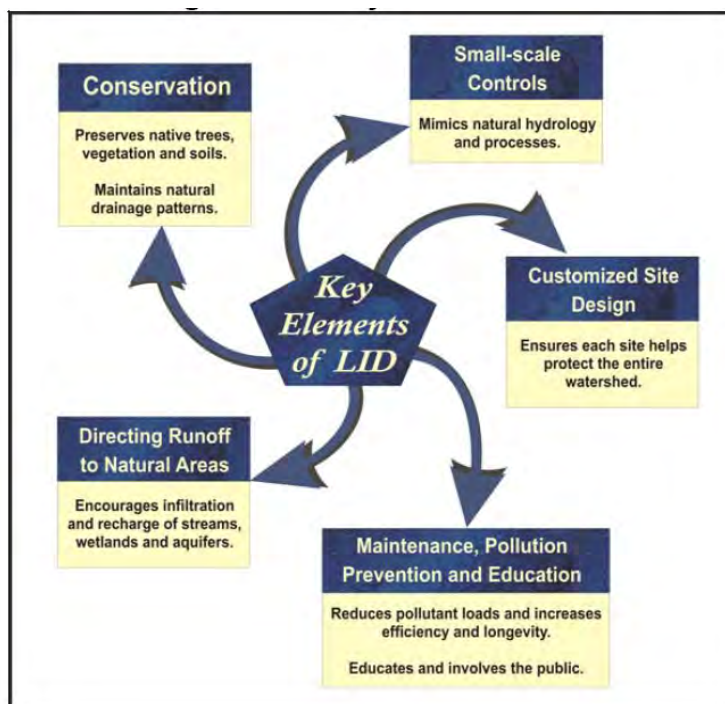

Figure 6.2.3 – Key elements of LID.



This is in contrast to the current practice of grading a site to quickly move water away from buildings and roadways. Until LID designs become the normal way of doing business a good design will require more time and creativity to manage runoff within the landscape effectively.

Basic LID principles include:

1. Optimize conservation – Save natural resource areas, vegetation and soils and wisely use them to reduce and treat runoff to maintain the site's ability to retain and detain runoff.
2. Mimic the natural water balance – To the extent possible continue to store detain and infiltrate water in the manner and rate as predevelopment. This requires careful evaluation of site soils in order to save sandy soils and use these areas as part of the LID control strategy. Conserving natural drainage features and topography will help to maintain the natural frequency of discharges.
3. Disconnect Impervious Surfaces – Always disconnect impervious surfaces. The site's runoff characteristics are completely changed when impervious surfaces drain to landscape features or engineered LID practices. This approach prevents the adverse cumulative effects of collecting and concentrating flows and helps to reduce erosion problems.
4. Decentralize and Distribute Controls – The more LID techniques used and the more uniformly distributed throughout the landscape the more effective LID becomes. Increasing runoff time of travel significantly reduces flows and discharge frequencies. Increasing storage features decreases runoff volume and reduces annual pollutant loads. Utilizing all landscape features for filtration increases its capacity to capture and cycle pollutants.
5. Multifunctional/Multipurpose Landscapes – Every aspect of the urban landscape can be design to either reduce or restore hydrologic functions. Every landscape feature should be optimized to provide beneficial hydrologic and water quality functions by preventing, storing, retaining, detaining, and treating runoff.
6. Cumulative Impacts of Multiple Systems – LID relies on cumulative beneficial impacts of an array of LID planning and design principles and various treatment practices. As more LID techniques are used to store or detain runoff, the developed site also more closely replicates the natural hydrologic regime. One interesting aspect of LID--because so many techniques are used, failure of a few practices does not significantly compromise management objectives. Contrast this with using one large stormwater pond—if that one big pond fails, the entire system fails.
7. Prevention, Outreach and Education – All efforts should be made to reduce the introduction of pollutants into the environment. Therefore, a good LID program or project also includes effective public education and outreach to help ensure proper use, handling, disposal of pollutants, and maintenance of LID practices.

The first three of these principles lend themselves to development of specific design standards and are used in *Section 6.4* of this guidance to organized LID practices.

## 6.2.2 Site Planning and Design Process

The LID approach emphasizes the use of site design and planning techniques to conserve natural systems and hydrologic functions. LID is also a highly engineered design and management strategy, which integrates practices throughout a development.

The simplest and least costly LID technique is good site planning; and an important goal of LID is to mimic the predevelopment hydrology to the extent practicable. To accomplish this, LID projects require a thorough understanding of the site's soils, drainage patterns, and natural features.

Developers should use natural features, hydrology and soils as a design element. In order to minimize the runoff potential an understanding of site drainage patterns and soils can suggest locations both for green areas and potential building sites. Integration of natural features into the site design creates a more ecologically functional site and a more aesthetically pleasing landscape that will be a vital functioning part of the ecosystem. Outlined below is the basic LID site process.

### 6.2.2.1 Step 1 – Define Basic Project Objectives and Goals

Identifying the project objectives not only includes identifying regulatory needs, but also ecological needs. Ecological needs include these fundamental aspects:

- Runoff volume to match predevelopment.
- Peak runoff rate to meet regulatory needs.
- Flow frequency and duration to match predevelopment.
- Water quality to meet regulatory requirements.
- Stream or wetland base flow needs.
- Recharge areas.
- Natural resource conservation requirements.

To ensure ecological needs receive appropriate attention, the developer should prioritize and rank objectives and determine the type controls required to meet objectives such as infiltration, filtration, discharge frequency, volume of discharges and groundwater recharge. Determine the feasibility for type and proper location of LID controls to best address volume, flows, discharge frequency, discharge duration and water quality.



Figure 6.2.4 – integration of resource conservation into a conventional design.

### 6.2.2.2 Step 2 – Site Evaluation and Analysis

A site evaluation will facilitate design by providing details that will help to customizing LID techniques for the sites unique constraints, regulatory requirements and receiving water goals.

1. Conduct a detailed investigation of the site using available documents such as drainage maps, utilities information, soils maps, land use plans, and aerial photographs.
2. Evaluate site constraints such as available space, soil infiltration characteristics, water table, slope, drainage patterns, sunlight and shade, wind, critical habitat, circulation and underground utilities.
3. Identify protected areas, setbacks, easements, topographic features, sub drainage divides, and other site features that should be protected such as floodplains, steep slopes, and wetlands.
4. Delineate the watershed and micro-watershed areas. Take into account previously modified drainage patterns, roads, and stormwater conveyance systems.

Many other unique site features may influence the site design including historical features, view sheds, climatic factors, energy conservation, noise, watershed goals, onsite wastewater disposal and off-site flows. All of these factors help to define the building envelop and natural features to be integrated into the LID design.

### 6.2.2.3 Step 3 – Optimize Conservation of Natural Features at the Larger Watershed Scale

LID does not promote the use of any particular style site development such as traditional neighborhood design, conventional grid patterns, cluster development, conservation design or new urbanism. Regardless of the development style, LID techniques can always be used throughout the site. The examples to the right (*Figure 6.2.4*) demonstrate integration of resource conservation into a conventional design. Natural features are saved to reduce impacts and allow for greater use of natural features to treat runoff. Conserving natural features not only reduces impacts but preserves habitat and natural ecological processes to be used for stormwater controls.

The most successful LID design begins with understanding of the site's natural resources and how best to save these features

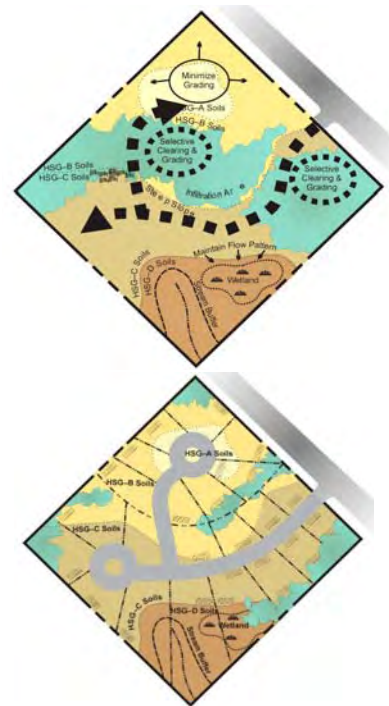

Figure 6.2.5 – Optimizing the use of green space.

and incorporate them into the stormwater management system. To the extent practicable and in accordance with current regulations, natural features (wetlands, trees/vegetation, good soils) should be conserved and integrated into the overall site plan. The conservation features should continue to be used by directing runoff to the natural features in the same manner as the predevelopment conditions. The greater use of natural features generally means reduction of clearing and grading and lower cost.

Locating infrastructure to direct runoff to buffers, vegetative filters, existing drainage features will help to reduce runoff quantity and improve water quality. This approach reduces disturbance of the natural soils and vegetation allowing more areas for infiltration and runoff contact with the landscape. To optimize the use of green space requires an ability to lay out the site infrastructure in a way that allows saving sensitive the natural features and their functions. The basic strategy is shown in *Figure 6.2.5* on the next page.

There are many techniques that should be considered including:

- Minimizing and properly stage grading and clearing for roadways and building pads as only necessary.
- Locating, saving and utilizing pervious soils.
- Locating treatment practices in pervious hydrologic soil groups A and B.
- *Where feasible*, constructing impervious surfaces on less pervious hydrologic soils groups C and D.
- Disconnecting impervious surfaces by draining them to natural features.
- Flattening slopes where possible.
- Re-vegetating cleared and graded areas.
- Utilizing existing drainage patterns.
- Routing flow over longer distances.
- Using overland sheet flow.
- Maximizing runoff storage in natural depressions.

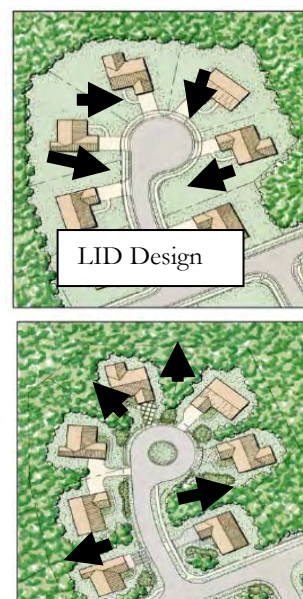

Figure 6.2.6 - conventional approach of draining runoff to the streets vs. a LID design using site fingerprinting.

#### 6.2.2.4 Step 4 – Minimize Impacts at the Lot Level

To the extent practicable, conserve trees, natural drainage patterns, pervious soils and depressions at the lot level. This often means less clearing and grading. *Figure 6.2.6* contrasts the conventional approach of draining runoff to the streets vs. a LID design using site fingerprinting where runoff is directed to the natural features.

The key to preventing excessive runoff from being generated is slow down velocities by directing it toward areas where it can be absorbed. The reliance on many small measures used throughout the site will serve this purpose better than a single large control measure.

There are many lot level techniques that should be considered including:



- Disconnecting roof drains.
- Directing flows to vegetated areas.
- Direct flows from paved areas to stabilized vegetated areas.
- Breaking up flow directions from large paved surfaces.
- Encouraging sheet flow through vegetated areas.
- Locating impervious areas so that they drain to permeable areas.
- Maximize overland sheet flow.
- Lengthening flow paths and increase the number of flow paths.
- Maximizing use of open swale systems.
- Increasing (or augmenting) the amount of vegetation on the site.
- Using site fingerprinting. Restrict ground disturbance to the smallest possible area.
- Reduce paving.
- Reducing compaction or disturbance of highly permeable soils.
- Avoiding removal of existing trees.
- Using on-lot tree save areas.
- Reducing the use of turf and use more natural land cover.
- Maintaining existing topography and drainage divides.
- Locating structures, roadways on Type C soils *where feasible*.<sup>10</sup>

Various lot level techniques are illustrated in *Figure 6.2.7* below.



Figure 6.2.7 – Lot level techniques.

<sup>10</sup> Because Type C and D soils tend to be poorly suited to construction, site structures on them may be ineffective from a cost-benefit standpoint or technically impractical.

## 6.3 Use of Integrated Management Practices in Various Settings

IMPs are those techniques used to treat additional runoff volume needed to meet regulatory needs or receiving water goals that were not obtained during the site planning process. These practices create additional volume storage, detention and filtration opportunities to increase the treatment capacity of the landscape.

IMPs can be applied in a variety of settings. The remainder of this section focuses on the use of IMPs in several specialized settings:

- Low- to medium-density residential settings.
- Commercial, industrial and high-density residential settings.
- Roadways.
- Retrofits and redevelopment.

### 6.3.1 Integrated Management Practices in a Residential Setting

In addition to the many possible site planning techniques used, additional treatment can be provided using the following engineered practices listed below. *Figure 6.3.1* provides a schematic example of a combination of practices. Some potential applications of IMPs are discussed below.

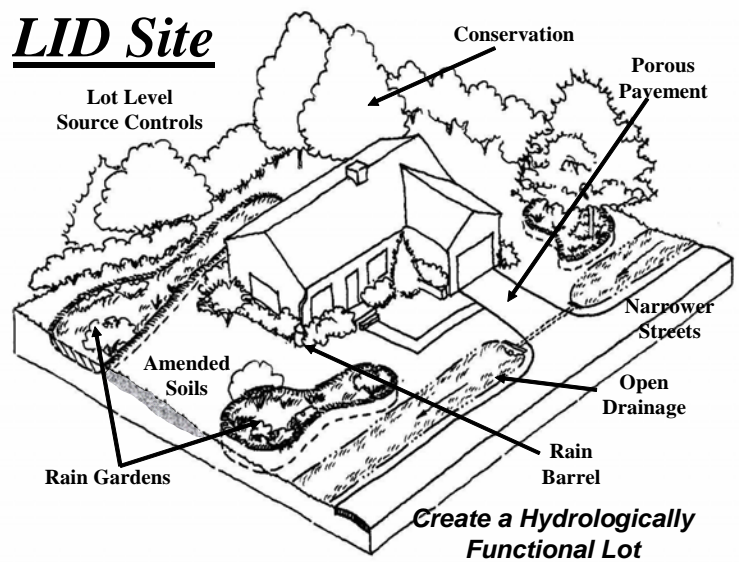

Figure 6.3.1 – Schematic of engineered practices.

- Bioretention or Rain Gardens – Vegetated depressions that collect runoff and either filter before discharge or infiltrate it into the ground.
- Dry Wells – Gravel- or stone-filled pits that are located to catch water from roof downspouts or paved areas.
- Filter Strips – Bands of dense vegetation planted immediately downstream of a runoff source designed to filter runoff before entering a receiving structure or water body.
- Grass Swales – Shallow channels lined with grass and used to convey and store runoff.
- Infiltration Trenches – Trenches filled with porous media such as bioretention material, sand, or aggregate that collect runoff and exfiltrate it into the ground.

- Permeable Pavement – Asphalt or concrete rendered porous by the aggregate structure.
- Permeable Pavers – Manufactured paving stones containing spaces where water can penetrate into the porous media placed underneath.
- Rain Barrels and Cisterns – Containers of various sizes that store the runoff delivered through building downspouts. Rain barrels are generally smaller structures, located above ground. Cisterns are larger, are often buried underground, and may be connected to the building's plumbing or irrigation system.
- Soil amendments – Minerals and organic material added to soil to increase its capacity for infiltration, absorbing moisture and sustaining vegetation.
- Planter box filters – Curbside containers placed below grade, covered with a grate, filled with filter media and planted with a tree in the center.
- Vegetated Buffers – Natural or man-made vegetated areas adjacent to a waterbody, providing erosion control, filtering capability, and habitat.
- On-lot tree-save areas – Runoff can be directed to existing on-lot tree conservation areas to encourage stormwater retention.
- Small detention features – For example driveway culverts can be undersized to detain flow and encourage stormwater retention.
- Infiltration Swales – Swales designed with infiltration trenches.

### 6.3.2 Integrated Management Practices for High Density Industrial, Commercial and Residential Development

It is relatively easy to understand how LID principals and practices can be applied to single family residential development where there is ample space. High density development seems much more challenging with little green space available for LID practices. However, there is little difference in the application of LID site design principles nor the use of small scale engineered practices for volume and water quality control. The only difference is LID practices must be designed to accommodate building architecture, sidewalks, parking lots, streets and landscaping.

It is still important to optimize the conservation and use of natural resources and soils on the larger project level and where feasible minimize impacts internal to the site.

The examples shown in *Figure 6.3.2* provide general LID design strategies for office buildings, small commercial buildings and big box sites. These site designs include a variety of techniques.



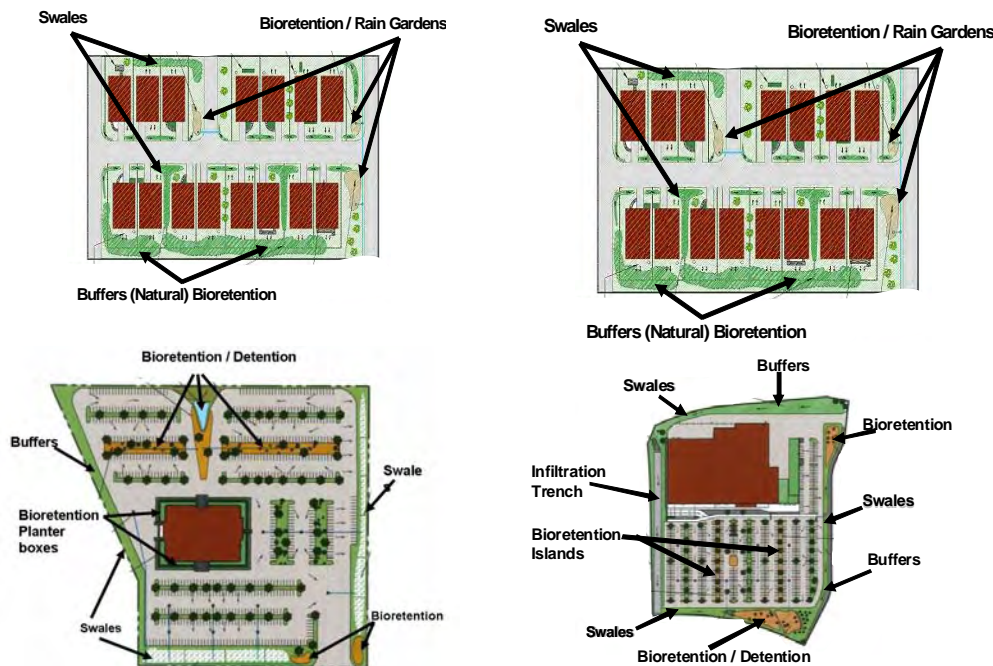

Figure 6.3.2 – LID design strategies for office buildings, small commercial buildings, and big box sites.

Typical LID techniques used for high-density developments include: perimeter buffers, swales and bioretention systems; parking lot bioretention/detention islands, planter boxes, green roofs, porous pavers/pavement and infiltration devices and underground storage. Runoff can be stored for use or controlled under buildings, parking lots and sidewalks using porous pavers and volume storage devices.

LID techniques can be integrated throughout the available green space using a range of bioretention techniques such as planter boxes, swales and street trees. In addition to the LID techniques previously listed, other engineered practices for high density development are included below. *Figure 6.3.3* provides a schematic example.

- Planter Boxes – Bioretention systems within containers designed for filtration and or infiltration.
- Green Roofs – Vegetated roofs designed for retention / detention storage and, filtration.
- Underground Storage – Use of cisterns, pipes, vaults or other storage devices for retention or detention storage.
- Porous Pavers and Surfaces – Porous surfaces design in combination gravel storage or other.
- Street and Parking Lot Detention – Shallow ponding allowed in ways that will not damage property or pose a safety risk.

- Manufactured Devices – Numerous commercial devices are available for filtration, screening, storage and treatment that can be integrated in the high density development.
- Building Architecture – Buildings can be designed to capture hold and use more runoff with, cisterns, planter boxes and wall planting systems.



Decentralized Stormwater Controls in Urban Retrofit Streetscape

Figure 6.3.3 – Schematic example of engineered practices in an urban retrofit streetscape.

### 6.3.3 LID Roadway Designs

Roadways generate a major portion of runoff in urban areas and present significant engineering challenges in developing effective LID roadway controls. Despite the challenges there are effective LID design principles and engineering practices available for any roadway system to meet water quality objectives. However, use of some techniques may require modification roadway design standards. Further, in highly urbanized development, site constraints (limited space, poor soils and utility conflicts) often require more extensive engineering and use of more expensive structural LID practices.

A LID roadway design does not require reduction of impervious surface but rather optimizing the integration of LID practices by engineering the roadway itself or the surrounding landscape/streetscape to provide storage, detention or filtration as applicable. Reduction of the roadway surfaces is most useful in creating additional space for the use LID practices. Impervious reduction alone has a very minor overall benefit (if any) in reducing runoff volume or improving water quality. It is much more important to hydraulically disconnect roadway surfaces by directing runoff to LID practices for storage, detention or infiltration.

### 6.3.3.1 Open Section Roadways

Open section roadways consist of a variable-width gravel or grass shoulder, usually wide enough to accommodate a parked car, and an adjoining grassed swale that conveys and treats runoff. When feasible, reducing road width provides greater opportunities to increase the width of grass shoulders and swales for treatment.

Street pavements width should be adjusted accordingly depending on off-street parking availability and shoulder requirements. Where feasible preserve existing vegetation and drainage features adjacent to the shoulder or swale. Also consider placing utilities under street pavements to eliminate conflicts with tree roots, grassed swales, and bioretention areas.

Since LID's primary goal is not to reduce impervious surfaces but make the landscape more functional to absorb and filter water. There is no need to reduce the use of sidewalks. *Figure 6.3.4* shows a standard 60-foot roadway design with sidewalks on both sides. The important LID feature is the use of wider more functional swales for treatment and control. Notice that the swales are located between the road surface and sidewalks providing greater protection to pedestrians.

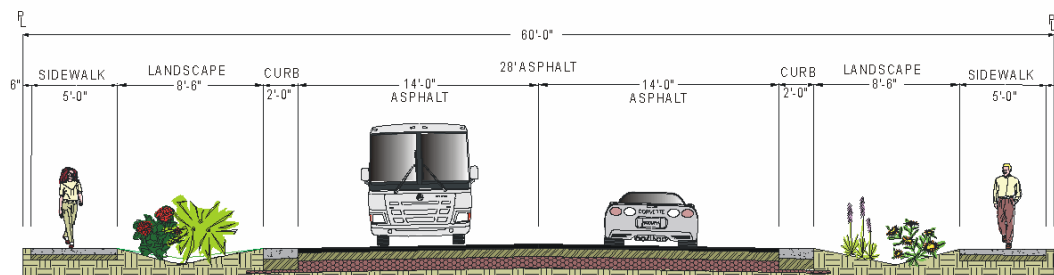

Figure 6.3.4. Open section roadways.

#### LOW IMPACT RESULTS

- 28% LESS ASPHALT SURFACE
- 10-14% STORM WATER RUNOFF REDUCTION
- 125% INCREASE IN GREEN SPACE

The figure below (*Figure 6.3.5*) shows a narrow road section with sidewalks, shallow swale and porous pavement shoulders. The paver blocks provide a rough surface to alert drivers if their tires leave the road surface. The pavers also protect the edge of the asphalt surface from braking off. Generally, very shallow and broad swales are preferred as they provide more surface area to treat and absorb runoff. Swale performance can be greatly enhanced when you can take advantage of infiltration.



Figure 6.3.5 - Narrow road section with sidewalks, shallow swale and porous pavement shoulders.

The figure below (*Figure 6.3.6*) shows an example of how to design a swale to enhance its ability to filter and infiltrate runoff. In this case several features have been incorporated into the design including using the culvert as a weir for detention control; check dams to increase ponding time and decrease velocities; trench drain along the bottom of the swale to encourage infiltration and increase runoff storage in the engineered soil. Road water quality treatment swales should be designed to be shallow with under drains if possible to encourage good drainage and discourage standing water and associated nuisance problems.

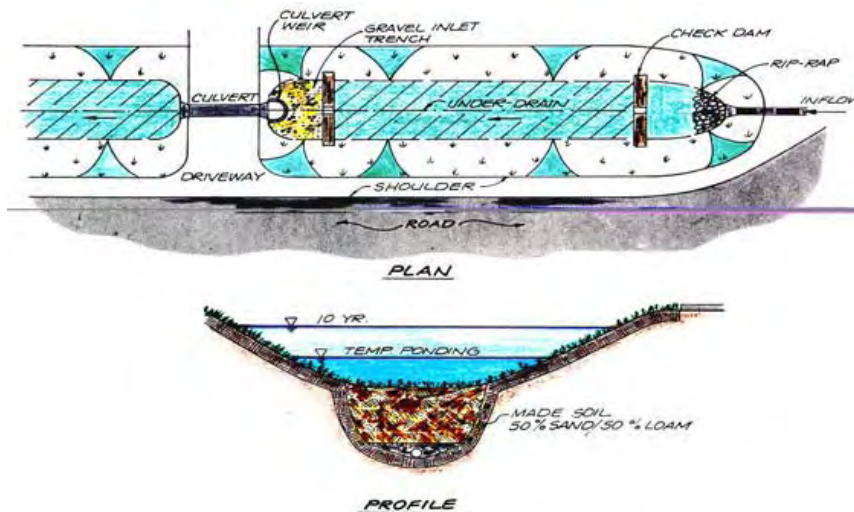

Figure 6.3.6 - Swale design to enhance its ability to filter and infiltrate runoff.

When it is possible to use narrower roadways the table below (*Table 6.2*) provides suggested general guidance. Even a narrow street width of 22 feet can still accommodate parking on one side of the roadway and leave ample room for a safe travel lane that is generous enough to accommodate most fire trucks, school buses, and garbage trucks.



**Table 6.2**  
**General Guidance for Narrower Roadways**

Local Streets	
No On-Street Parking	18 feet
Parking on One Side	22 to 24 feet
Parking on Both Sides	24 to 26 feet
Collector Streets	
	32 to 36 feet

Source: *Residential Streets*, NAHB, 2001.

### 6.3.3.2 CUL-DE-SAC Designs

Homebuyers often prefer cul-de-sac properties for many reasons, and thus cul-de-sacs have become quite common. Depending on a subdivision's lot size and street frontage requirements, five to ten houses can usually be located around a standard cul-de-sac perimeter. The bulb shape allows vehicles up to a certain turning radius to navigate the circle. To allow emergency vehicles to turn around, cul-de-sac radii can vary from as narrow as 30 feet to upwards of 60 feet, with right-of-way widths usually extending ten feet beyond these lengths. *Figure 6.3.7* shows an open section roadway with on lot bioretention and a cul-de-sac with a bioretention area in the center for roadway runoff.

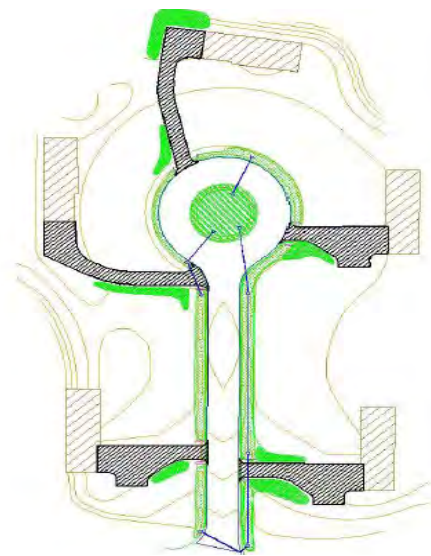

Figure 6.3.7 – Cul-de-sac designs.

### 6.3.3.3 Divided Highways

The wider right-of-ways of divided highways provide many opportunities for LID practices on the shoulders and in the median. *Figure 6.3.8* and *Figure 6.3.9* provides examples of these options.



Figure 6.3.8 – Examples of center median infiltration/filtration systems.



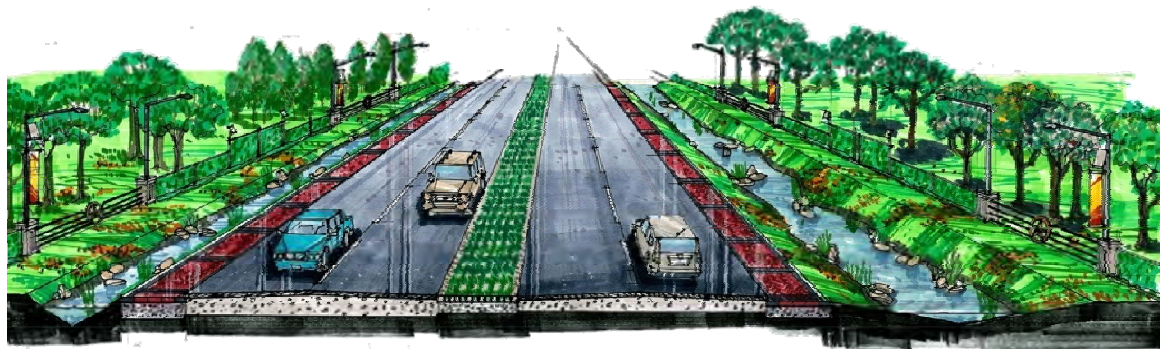

Figure 6.3.9 - Shoulder Treatment Systems using detention and filtration design.

### 6.3.3.4 Highly Urbanized LID Street Design

Below are two examples of planter box designs in high density development (*Figure 6.3.10*). The image on the left is a slow flow system that requires very large surface areas to treat the water quality volume. The image on the right is a very high flow media system that has an extremely small footprint saving space reducing overall construction and maintenance costs. However, both provide the same water quality treatment benefits. Both systems can be designed with underground storage for detention infiltration or retention to be used for irrigation. There are many devices that can be used for underground storage ranging from metal, plastic or concrete pipes to a variety of plastic prefabricated storage devices.



Figure 6.3.10 – Examples of planter box designs in high density development in Connecticut.



### 6.3.3.5 Porous Surfaces

Porous pavers, asphalt and concrete are all other design options to provide a hard surface suitable for roadways that allow runoff to percolate into underground gravel beds or other storage devices for detention or infiltration. An example is provided below as *Figure 6.3.11*. To reduce the cost these surfaces they should not be placed over the entire roadway but rather strategically placed and sized to allow sufficient runoff volume to enter the underlying storage device.



Figure 6.3.11 – Porous surfaces

### 6.3.3.6 Other LID Roadway Design Considerations

- Maximize natural drainage – when planning streets, consider preserving natural drainage patterns and soil permeability by preserve natural drainage patterns and avoid locating streets in low areas or highly permeable soils.
- Uncurbed roads – where feasible, build uncurbed roads using vegetated swales as an alternative.
- Urban curb/swale system – runoff runs along a curb and enters a surface swale via a curb cut, instead of entering a catch basin to the storm drain system.
- Dual drainage system – a pair of catch basins with the first sized to capture the water quality volume into a swale while the second collects the overflow into a storm drain.
- Concave medians – median is depressed below the adjacent pavement and designed to receive runoff by curb inlets or sheet flow. Can be designed as a landscaped swale or a biofilter.

- Street Length – Reduce the length of residential streets by reviewing minimum lot widths and exploring alternative street layouts.
- Access – Consider access for large vehicles, equipment, and emergency vehicles when designing alternative street layouts and widths.
- Right-of-way – should reflect the minimum required to accommodate the travel lane, parking, sidewalk, and vegetation, if present.
- Permeable materials – use in alleys and on-street parking, particularly pull out areas.

### 6.3.4 Urban Retrofit and Redevelopment

The poor state of our surface waters is the direct result of increased runoff volume and pollution loads from existing development. If impaired receiving waters are to be restored the impacts from existing development must be addressed. LID practices allow for retrofit of developed areas by integrating small-scale management techniques into the urban landscape (roads, sidewalks, parking areas, buildings, etc.). In most cases existing landscape features can simply be converted into bioretention systems for filtration, detention and infiltration. In more difficult cases storage can be provided under sidewalks and parking lots or on rooftops.

The most economical way to retrofit existing development is to ensure that all infill development, redevelopment and reconstruction projects include the LID practices. Over time as urban areas are redeveloped and rebuilt with LID practices much of the urban runoff can be treated greatly reducing water quality impacts and reducing flooding potential. The City of Portland, OR has evaluated such an urban retrofit program and has found over a 50-year period much of the City's runoff can be controlled and treated by green roofs and bioretention streetscape systems for roadway and parking lot runoff.

When selecting the most appropriate retrofit techniques it is important to select LID practices that can best address receiving water quality and volume needs. For example, where receiving waters are impaired by heavy metals or bacteria bioretention filtration and/or infiltration techniques would be most appropriate. Where volume control is necessary for detention porous surfaces or filtration devices in combination with underground storage detention and/or infiltration practices are best.

### 6.3.4.1 Retrofit Case Studies

Retrofit and redevelopment projects utilizing LID techniques have been implemented throughout the country in recent years. Multiple projects have occurred in Connecticut. For example, a traffic control project calling for access management adjacent to North Main Street in the City of Bridgeport, CT, incorporated rain gardens/bioretenion and permeable pavement into project design. Specifically, North Main Street was narrowed and permeable pavement was installed alongside portions of the roadway to accommodate vehicular parking and treat storm water runoff. Additionally, series of rain gardens were installed along the sidewalk to receive and treat storm water runoff. Photographs of the LID techniques implemented along Main Street are provided as *Figure 6.3.12*.



Figure 6.3.12 – Permeable pavement (left photograph) and rain garden/bioretenion (right photograph) retrofits along North Main Street in Bridgeport, CT.

Another example of green infrastructure retrofit project is the Hartford Green Capitols project. This project focused on Connecticut's capitol building in Harford, CT and included installation of porous pavement, green roofs, and rain gardens, as well as rain harvesting techniques. Such techniques served to improve water quality and educate state residents about green infrastructure. Photographs of the LID techniques implemented as part of the Hartford Green Capitols Project are provided as *Figures 6.3.13-6.3.15*.





Figure 6.3.13 – Green roof at Hartford Green Capitols Project. Source: Camp Dresser & McKee.



Figure 6.3.14 – Construction of a rain garden at Hartford Green Capitols Project. Source: Camp Dresser & McKee.



Figure 6.3.15 – Permeable pavement at Hartford Green Capitols Project. Source: Camp Dresser & McKee.

Additional examples of techniques used in Connecticut for both retrofit and redevelopment projects are provided as *Figure 6.3.16* on the next page.



Bioretention area at University of Connecticut Storrs Campus.



Roads are narrowed and permeable pavement is installed along roadways to provide additional parking and treat runoff.



Figure 6.3.16 – Retrofit and redevelopment techniques in Connecticut. Source: Connecticut Department of Environmental Protection.

## 6.4 Design Standards for Low Impact Development Controls

This section discusses design standards for LID controls. It provides a general description of each control, its advantages, general use, and standards for its application. The stormwater practices and techniques covered in this section are grouped to support the first three design principles listed in *Section 6.2.1* of this summary (see below):

- Approaches that Optimize Conservation
  - Limits of Clearing and Grading
  - Preserving Natural Areas
  - Avoid Disturbing Long, Steep Slopes
  - Minimize Siting on Porous and Erodible Soils
- Approaches that Mimic Natural Water Balance
- Approaches to Minimizing and Disconnecting Impervious Surface
  - Roadways
  - Buildings
  - Parking Footprints
  - Parking Lot Islands
  - Disconnecting Impervious Area

### Alternatives to Incorporate LID

Some approaches to optimize conservation already exist in current Connecticut stormwater guidance. The *Stormwater Quality Manual* provides discussions related to optimizing conservation in chapter 3 (especially sections 3.2, 3.3, and 3.5) and chapter 4 (especially sections 4.2 and 4.3). To directly incorporating the additional standards from *Sections 5.1 to 5.3* of this technical memorandum, would require a full rewrite of these chapters.

The *Guidelines for Soil Erosion and Sediment Control* provides discussion related to optimizing conservation in chapter 3, part II. The existing discussion in the Guidelines is somewhat general. If directly incorporating the standards is the preferred alternative for including LID, the standards from this technical memorandum could be rewritten to fit with approach in the Guidelines or chapter 3 of the Guidelines could be rewritten to include a greater level of detail.

Following this discussion is a discussion of design standards for IMPs, which is organized as follows:

- Integrated Management Practices at the Source
- Vegetated Filter Strips
  - Natural Drainage Ways
  - Green Roofs and Façade
  - Rain Barrels and Cisterns
  - Dry Wells
  - Bioretention and Rain Gardens
  - Infiltration



## 6.4.1 Approaches that Optimize Conservation

*Section 6.4.1* discusses specific LID controls intended to optimize conservation.

### 6.4.1.1 Limits of Clearing and Grading

Perhaps the most potentially destructive stage in land development is the preparation of a site for building—clearing of vegetation and soil grading (Schueler, 1995). The limits of clearing and grading refer to the part of the site where development will occur. This includes all impervious areas such as roads, sidewalks, rooftops, as well as areas such as lawn and open drainage systems.

To minimize impacts, the area of development should be located in the least sensitive areas available. At a minimum, developers should avoid streams, floodplains, wetlands, and steep slopes (see *Section 6.4.1.3*). Where practicable, developers should also avoid soils with high infiltration rates as these will aid in reducing runoff volumes (see *Section 6.4.1.4*).

#### Advantages

- Preserves more undisturbed natural areas on a development site.
- Techniques can be used to help protect natural conservation areas and other site features.
- Promotes evapotranspiration and infiltration to reduce need for treatment and peak volume control at end-of-pipe.
- Reduces generation of stormwater.
- Helps to demonstrate compliance with regulatory standards (e.g., freshwater wetlands, coastal resources, water quality, wildlife, local environmental protection, etc.) for avoidance and minimization as well as setbacks from sensitive features.
- Maintains predevelopment hydrology, natural character and aesthetic features that may increase market value.
- Promotes stable soils.
- May reduce landscaping costs.

#### Use

Establishing a limit of disturbance based on maximum disturbance zone radii/lengths. These maximum distances should reflect reasonable construction techniques and equipment needs together with the physical situation of the development site such as slopes or soils. Limits of disturbance may vary by type of development, size of lot or site, and by the specific development feature involved.

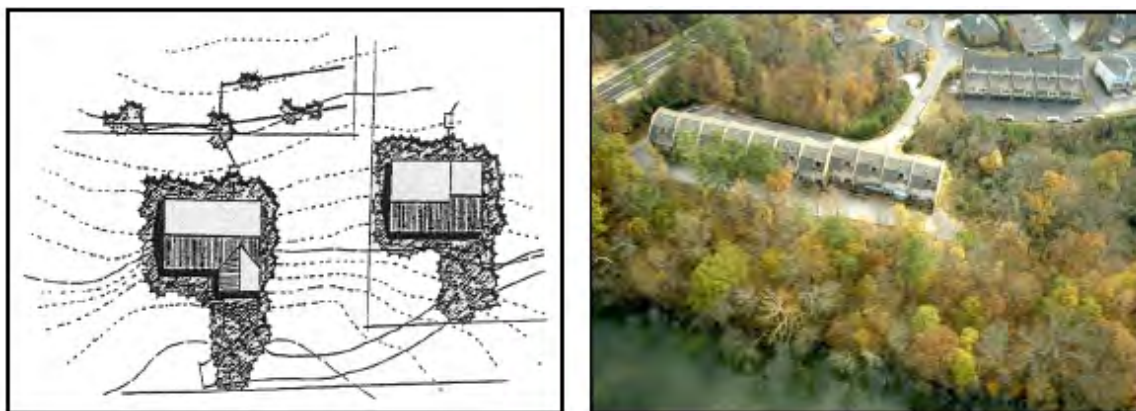

Figure 6.4.1 - Reduced limits of disturbance minimize water quality impacts. Source: Atlanta Regional Commission, 2001.

## Standards

Generally speaking, limits of disturbance need not comprise more than:

- a) Area of the building pad plus 15 feet.
- b) Area of a roadbed and shoulder plus 5 feet. (This is not intended to limit lawn areas.)

### 6.4.1.2 Preserving Natural Areas

Natural areas include woodlands, riparian corridors, areas contiguous to wetlands and other hydrologically sensitive and naturally vegetated areas. To the extent practicable these areas should be preserved.

Natural areas can be one of the most important components within a development scheme, not only from a stormwater management perspective, but in reducing noise pollution and providing valuable wildlife habitat and scenic values. New development tends to fragment large tracts of undisturbed areas and displace plant and animal species; therefore it is essential to maintain these buffers in order to minimize impacts. Areas adjacent to waterbodies (both freshwater and coastal) are protected under state law and cannot be altered without a state agency permit.

## Advantages

- Promotes evapotranspiration and infiltration to reduce need for treatment and peak volume control at end-of-pipe.
- Reduces generation of stormwater.
- Helps to demonstrate compliance with regulatory standards (e.g., freshwater wetlands, coastal resources, water quality, wildlife, local environmental protection, etc.) for avoidance and minimization as well as setbacks from sensitive features.
- Reduces safety and property-damage risks where flood hazard areas are incorporated into preservation.
- Maintains predevelopment hydrology, natural character and aesthetic features that may increase market value.

- Promotes stable soils.
- Establishes and maintains open space corridors.

## Use

- Check all federal, state and local enforceable policy to ensure proper setbacks and identification of preservation areas. Identify areas for preservation through site analysis using maps and aerial or satellite photography or by conducting a site visit.
- Delineate areas for preservation via limits of disturbance before any clearing or construction begins and should be used to set the development envelope as well as guide site layout. Clearly mark areas for preservation on all construction and grading plans to ensure that equipment is kept out of these areas and that native vegetation is kept in an undisturbed state.
- Protect preservation areas in perpetuity by legally enforceable deed restrictions, conservation easements and maintenance agreements.

Figure 6.4.2 shows a site map with undisturbed natural areas delineated.

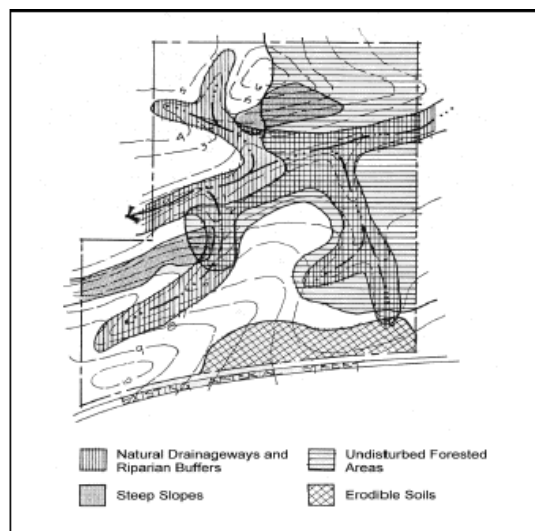

Figure 6.4.2 – Site map with natural areas delineated. Source: Atlanta Regional Commission, 2001.

## Special Considerations

### *Riparian Buffers*

A riparian buffer is a special type of preserved area along a watercourse where development is restricted or prohibited. Buffers protect and physically separate a watercourse from development. Riparian buffers also provide stormwater control flood storage and habitat values. An example of a riparian buffer is shown in *Figure 6.4.3*. Wherever possible, riparian buffers should be sized to include the 100-year floodplain as well as steep banks and freshwater wetlands.



Figure 6.4.3 – Riparian buffer along the French River, in Thompson, CT. Source: Connecticut Department of Environmental Protection.

Riparian buffers consist of three zones (see *Figure 6.4.4*):

- The inner zone consists of the jurisdictional riverbank wetland and should have a width of no less than 100 feet from the edge of a flowing body of water less than 10 feet wide and no less than 200 feet from the edge of a flowing body of water greater than 10 feet wide. In addition to runoff protection, this zone provides bank stabilization as well as shading and protection for the stream. This zone should also include wetlands and any critical habitats, and its width should be adjusted accordingly. Permits should be sought for activities in the inner zone. Generally speaking, structural best management practices (BMPs) are not allowed in the inner zone.

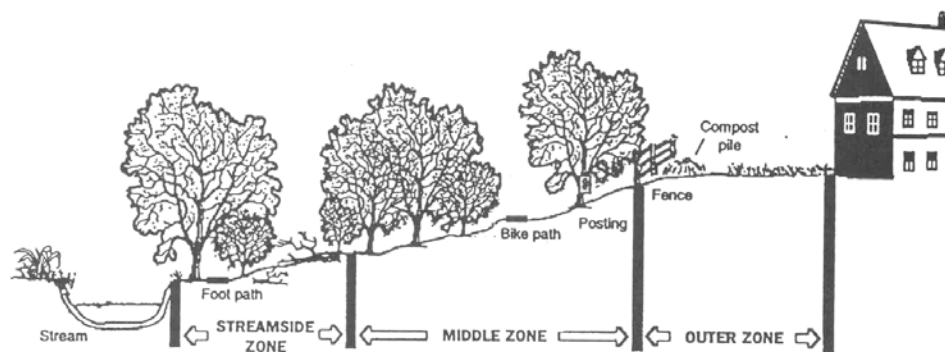

Figure 6.4.4 – Three-zone riparian buffer. Source: Atlanta Regional Commission, 2001.

- The middle zone provides a transition between upland development and the inner zone and should consist of managed woodland that allows for infiltration and filtration of runoff. A 25-foot width is recommended for this zone at a minimum. Forested riparian buffers should be maintained and reforestation should be encouraged where no wooded buffer exists. Proper restoration should include all layers of the forest plant community, including understory, shrubs and groundcover, not just trees.
- An outer zone allows more clearing and acts as a further setback for impervious surfaces. It also functions to prevent encroachment and filter runoff. A 25-foot width is recommended for this zone.

Ideally, all three zones of the riparian buffer should remain in their natural state. However, some maintenance is periodically necessary, such as planting to minimize concentrated flow, the removal of exotic plant species when these species are detrimental to the vegetated buffer and the removal of diseased or damaged trees.

### *Floodplains*

Floodplains are the low-lying flatlands that border streams and rivers. When a stream reaches its capacity and overflows its channel after storm events, the floodplain provides for storage and conveyance of these excess flows. In their natural state they reduce flood velocities and peak flow rates by the passage of flows through dense vegetation. Floodplains also play an important role in reducing sedimentation and filtering runoff, and provide habitat for both aquatic and terrestrial life. Development in floodplain areas can reduce the ability of the floodplain to convey stormwater, potentially causing safety problems or significant damage to the site in question, as well as to both upstream and downstream properties.

As such, floodplain areas should be avoided on a development site. Ideally, the entire 100-year floodplain at full buildout should be avoided for clearing or building activities, and should be preserved in a natural undisturbed state where possible. Maps of the 100-year floodplain can typically be obtained through the local review authority.

## **Standards**

### *General*

- a) No disturbance shall occur to preservation areas during project construction.
- b) Preserved areas shall be protected by limits of disturbance clearly shown on all construction drawings and clearly marked on site.
- c) Preservation areas shall be located within an acceptable conservation easement instrument that ensures perpetual protection of the proposed area. The easement must clearly specify how the natural area vegetation shall be managed and boundaries will be marked. [Note: managed turf (e.g., playgrounds, regularly maintained open areas) is not an acceptable form of vegetation management.]

- d) Preservation areas shall have a minimum contiguous area of 10,000 square feet or in the case of stream buffers must maintain a 50-foot set back from the jurisdictional wetland edge along the entire length of stream through the property of concern. Areas of smaller size may be incorporated for disconnection of impervious surface, but will be considered as open space in good condition.
- e) Incorporate level spreaders or other dispersion devices, where practicable, to ensure sheet flow. See *Figure 6.4.5*, which depicts a level spreader. (Please note that the level spreader shown here is for dispersion of low flows only.)

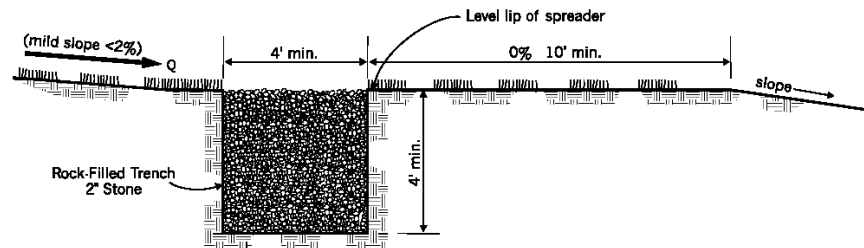

Figure 6.4.5 – Rock trench level spreader for low flows. Source: Prince George’s County, Maryland, 2000.

- f) Include bypass mechanisms for higher flow events to prevent erosion or damage to a buffer or undisturbed natural area.
- g) Consider incorporating constructed berms around natural depressions and below undisturbed vegetated areas to provide for additional runoff storage and infiltration. Proper use of berms is discussed in the section entitled vegetated filter strips.
- h) Where no berms are provided in Hydrologic Soil Group (HSG) type A and B soils, buffers may be used to attenuate and treat flows up to the water quality volume (i.e., volume equal to one inch over the impervious surface) in the following ratios:



**Table 6.3**  
**Ratio of Forested Buffer to Impervious Surface Required to Attenuate Runoff**  
**for Precipitation between 0.5 and 1.0 Inches<sup>a, b</sup>**

Runoff (inches)	HSG Soil Type			
	A	B	C	D
1.0	1:3	2:1	N/A	N/A
0.9	1:4	1:1	N/A	N/A
0.8	1:6	2:3	N/A	N/A
0.7	1:9	2:5	N/A	N/A
0.6	1:15	1:4	1:1	N/A
0.5	1:25	1:8	1:2	N/A

Notes:

<sup>a</sup>Buffer size calculations based on TR-55. Calculations for precipitation depths less than 0.5 inches are not included as the empirical equations of TR-55 become less accurate for storms less than 0.5 inches.

<sup>b</sup>Standards for buffer width, area and length of contributing flow path, etc. must be met regardless of soil's capacity to attenuate flow.

- i) Land cover in buffers will be assumed to be woods in good condition (i.e., Curve number (CN) equal to 32 in type A soil and 55 in type B soil). Type C and D may not be used for this purpose as woods on these soil types cannot abstract the depth of rainfall associated with one inch of runoff from the impervious surface.
- j) Runoff must enter the buffer as overland sheet flow. The average contributing slope should be no less than 1% and no more 3%. Maximum average slope may be increased to 5% if a flow spreader is installed across the entire contributing length followed by a flat (i.e., 0% slope) 10-foot shelf across the length.

*Streambank Areas*

- a) The minimum undisturbed buffer width shall be at least the wetland jurisdictional setback plus 50 feet (e.g., 150 feet for streams less than 10 feet wide).
- b) The maximum length of area contributing runoff should be no more than 150 feet for pervious surfaces and 75 feet for impervious surfaces. The minimum contributing length should be no less than 20 feet.

*Maintenance*

Except for routine debris removal, buffers shall remain in a natural and unmanaged condition.

### 6.4.1.3 Avoid Disturbing Long, Steep Slopes

Disturbance of long, steep slopes tends to cause soil erosion. Studies show that soil erosion is significantly increased on slopes of 15% or greater. In addition, the geometry of steep slopes means that greater surface areas are disturbed to locate facilities on them compared to flatter slopes as demonstrated in *Figure 6.4.6*.

#### Advantages

- Prevents soil erosion and sedimentation.
- Stabilizes hillsides and soils.
- Reduces the need for cut-and-fill and grading and may substantially reduce cost of development.

#### Standards

- a) Avoid development on steep slope areas. As a general rule do not exceed the following values:

#### Grade

0% - 7%  
7% - 15%  
over 15%

(Prince George's County, 2000)

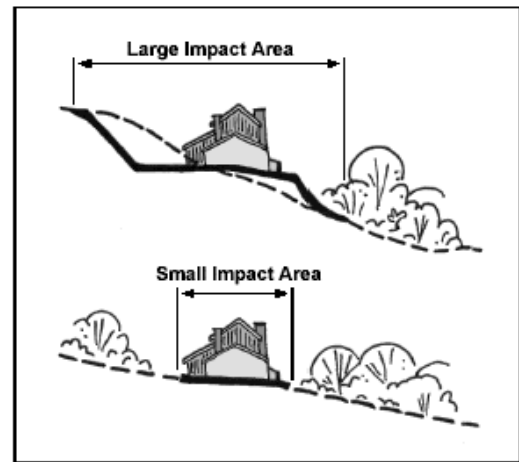

Figure 6.4.6 – Building on flatter slopes reduces the impact of development. Source: Atlanta Regional Commission, 2001.

#### Slope Length

300 feet  
150 feet  
75 feet

- b) On slopes greater than 25% (Georgia, 2000), no development, regrading, or stripping of vegetation should be considered unless the disturbance is for roadway crossings or utility construction. Erosion hazard risk increases as follows:

#### Grade

0% - 7%  
7% - 15%  
over 15%

(Prince George's County, 2000)

#### Erosion Risk

Low  
Moderate  
High

- c) Unnecessary grading should be avoided on all slopes, as should the flattening of hills and ridges.

- d) After cutting out soils, avoid inverting the soil horizons while filling.

#### 6.4.1.4 Minimize Siting on Porous and Erodible Soils

This technique discusses appropriate standards for managing development in areas of erodible and porous soils.

##### Advantages

- Areas with highly permeable soils can be used as nonstructural stormwater infiltration zones.
- Avoiding highly erodible or unstable soils can prevent erosion and sedimentation problems and water quality degradation.
- Infiltration of stormwater into the soil reduces both the volume and peak discharge of runoff as well as groundwater recharge.
- Infiltration provides for water quality treatment.

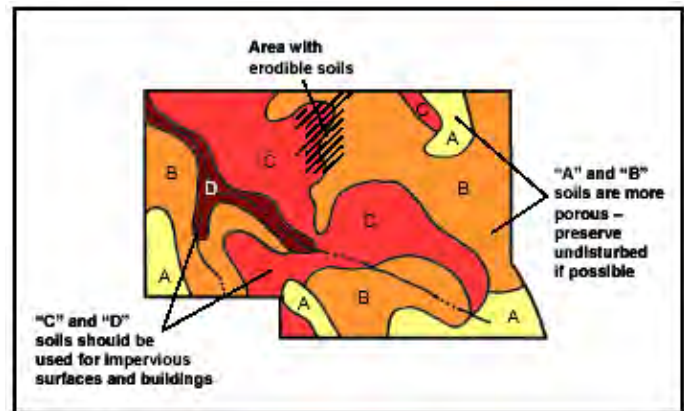

Figure 6.4.7 – Site plans depicting hydrologic soil groups.

##### Use

- a) Use soil surveys to determine site soil types.
- b) Delineate hydrologic soil types on concept site plans to guide site layout and the placement of buildings and impervious surfaces (see *Figure 6.4.7*).

##### Standards

- a) Whenever possible, leave areas of porous or highly erodible soils (hydrologic soil group A and B soils such as sandy and silty soils) as undisturbed conservation areas (see Preserve Natural Areas for more information on conservation areas).

##### Alternatives to Incorporate LID

Neither the *Stormwater Quality Manual* nor the *Guidelines for Soil Erosion and Sediment Control* provides a significant discussion of LID approaches that mimic natural water balance. However, chapter 4 of the *Stormwater Quality Manual* could be rewritten to include a section on this topic.

- b) Conversely, buildings and other impervious surfaces should be located on those portions of the site with the *least* permeable soils. Gravel soils tend to be the least erodible. Also as clay and organic matter increase erodibility tends to decrease.

## 6.4.2 Approaches that Mimic Natural Water Balance

LID controls mimic natural predevelopment hydrology in order to retain and attenuate stormwater runoff in upland areas. This reduces the amount of stormwater and intensity of flow at points of discharge. Flow attenuation prevents physical damage to waterways and reduces nonpoint source pollution. The remainder of *Section 6.4.2* discusses mimic natural water balance as a LID control.

### Advantages

- Decreased need for constructed BMPs.
- Maintains predevelopment hydrology and thus reduces generation of stormwater and associated pollution.
- Encourages groundwater recharge.

### Use

Mimicking predevelopment site hydrology involves a process of comparing and evaluating pre- and postdevelopment conditions that takes place in all stages of site planning. There are many methods of hydrologic analysis. This section of the manual relies on the use of the USDA-SCS Technical Release-55 (TR-55), entitled *Urban Hydrology for Small Watersheds* (1986).

#### *Time of Concentration and Time of Travel*

TR-55 focuses on the time of concentration (T<sub>c</sub>) as a primary influence in the shape and peak of runoff hydrographs. TR-55 defines time of concentration as the "time for runoff to travel from the hydraulically most distant point of the watershed to a point of interest within the watershed."

T<sub>c</sub> is calculated as follows:

$$T_c = T_t(1) + T_t(2) + \dots T_t(m)$$

Where:

T<sub>t</sub> (travel time) = time it takes runoff to move across a segment of the watershed.

m = total number of travel segments in a watershed

T<sub>t</sub> is mathematically defined by TR-55 as being directly influenced by two factors velocity of runoff (V) and length of runoff flow path (L). Velocity is further defined as a function of slope (s) and surface roughness (i.e., Manning's roughness coefficient for sheet flow) (n).

Tt is calculated as follows:

$$Tt = \frac{L}{3600 V}$$

Where:

Tt = travel time in hours  
 L = flow length in feet  
 V = average velocity in feet per second  
 3600 = conversion factor for seconds to hours

*Total Volume and Peak Discharge*

TR-55 also notes that total runoff volume (Q) and peak runoff discharge (qp) tend to increase as a result of urbanization. Peak discharge is defined as a factor of Q and can be calculated using as follows:

$$qp = qu Am Q Fp$$

Where:

qp = peak discharge in cubic feet per second  
 qu = unit peak discharge  
 Am = drainage area in square miles  
 Q = runoff in inches  
 Fp = pond and swamp adjustment factor

Q is derived as a factor of initial abstraction (Ia) and retention (S) and is calculated as follows:

$$Q = \frac{(P - Ia)^2}{(P - Ia) + S}$$

Where:

Q = runoff in inches  
 P = rainfall in inches  
 S = retention  
 Ia = initial abstraction

Initial abstraction is a measure of rainfall held in surface depressions, interception by vegetation, evapotranspiration and infiltration prior to the occurrence of runoff and is calculated as follows:

$$Ia = 0.02 S$$

Where:

Ia = initial abstraction  
 S = retention

Retention is a measure of total capacity for rainwater storage in a watershed during a rain event. In small agricultural watersheds retention is typically about 5 times greater than initial abstraction.

Retention is calculated as follows:

$$S = \frac{1000}{CN} - 10$$

Where:

S = retention

CN = curve number

Curve number is a coefficient ranging from 0 - 100, which is used to represent the conversion of rainfall to runoff. For example, an impervious surface such as concrete has a CN of 98, which is analogous to representing that 98% of rain that falls on concrete runs off.

*Identifying Hydrologic Benefits*

All nonstructural and distributed BMPs have one or more hydrologic benefits in relationship to TR-55. *Table 6.4* (below) summarizes key hydrologic benefits of nonstructural and distributed BMPs recommended in this manual.

**Table 6.4  
Hydrologic Benefits of  
Nonstructural and Distributed Techniques and Controls**

<b>Techniques &amp; Controls</b>	<b>Decrease Curve Number</b>	<b>Reduce Slope</b>	<b>Lengthen Flow Path</b>	<b>Increase Roughness</b>	<b>Increase Initial Abstraction</b>	<b>Increase Total Retention</b>
Reduce Limits of Clearing and Grading	● <sup>a</sup>		● <sup>b</sup>	●	●	
Preserve Natural Features	●		●	●	●	
Avoid Long, Steep Slopes		●	●		●	
Avoid Erodible Soils				●	●	
Avoid Porous Soils	●			●	●	
Minimize Roadways	●		●	●	●	
Minimize Buildings	●		●	●	●	
Minimize Parking	●		●	●	●	
Disconnect Impervious Area	●		●	●	●	



Techniques & Controls	Decrease Curve Number	Reduce Slope	Lengthen Flow Path	Increase Roughness	Increase Initial Abstraction	Increase Total Retention
Buffers and Undisturbed Areas	●		●	●	●	●
Infiltration Swales	●	◐	◐	●	●	●
Vegetative Filter Strips	●			●	●	●
Bioretention	●				●	●
Nonstructural Conveyances	●		◐	●	●	
Drain Rooftop Runoff to Pervious Areas			●	●	●	
Rain Barrels and Cisterns					●	●
Dry Wells					●	●
Green Roofs and Walls					●	●

Notes

<sup>a</sup> Benefit always occurs.

<sup>b</sup> Benefit occurs sometimes.

### Standards

*Time of Concentration*

The postdevelopment time of concentration ( $T_c$ ) should approximate the predevelopment  $T_c$ .

*Travel Time*

The travel time ( $T_t$ ) throughout individual lots and areas should be approximately constant.

*Flow Velocity*

Flow velocity in areas that are graded to natural drainage patterns should be kept as low as possible to avoid soil erosion.

Flows can be disbursed by installing a level spreader along the upland ledge of the natural drainage way buffer, and creating a flat grassy area about 30 feet wide on the upland side of the buffer where runoff can spread out. This grassy area can be incorporated into the buffer itself.



Figure 6.4.8 – Alternative roadway design in Waterford, CT. Source: Tom Walsh, Shoreline Aerial Photography

## 6.4.3 Approaches to Minimizing and Disconnecting Impervious Surface

A key concept of LID is the minimization and disconnection of impervious surface. For the purposes of stormwater management, impervious surfaces are commonly considered to include roads, parking lots, and buildings.

### 6.4.3.1 Roadways

The greatest share of impervious cover in most communities is from paved surface such as roads and sidewalks. Roadway lengths and widths should be minimized on a development site where possible to reduce overall imperviousness.

Numerous alternatives create less impervious cover than the traditional 40-foot cul-de-sac. These alternatives include reducing cul-de-sacs to a 30-foot radius and creating hammerheads, loop roads, and pervious islands in the cul-de-sac center (see *Figures 6.4.8 through 6.4.10*).

**Alternatives to Incorporate LID**

The Guidelines for Soil Erosion and Sediment Control do not currently address management of runoff from impervious surfaces as the scope of the Guidelines is really limited to development projects. The Stormwater Quality Manual currently includes some limited discussion of minimizing and disconnecting impervious surface under section 4.3. Chapter 4 could be rewritten to incorporate additional discussion of this topic.

Section 5.3.4 of this technical memorandum discusses specific standards for parking lot islands. These standards could be added to chapter 11 of the *Stormwater Quality Manual*.

#### Advantages

- Reduces the amount of impervious cover and associated runoff and pollutants generated.
- Reduces the costs associated with road construction and maintenance.

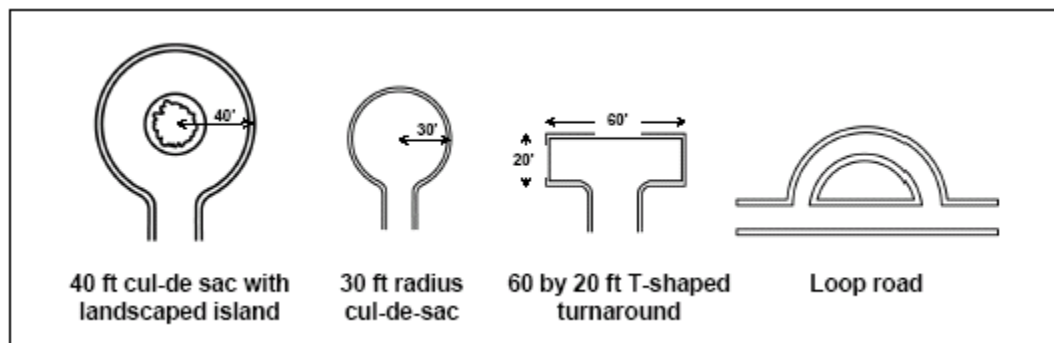

Figure 6.4.9 – Different styles of turnarounds. Source: Adapted from Atlanta Regional Commission, 2001.



Figure 6.4.10 – Cul-de-sac infiltration island accepts stormwater from surrounding pavement. Note flat curb. Source: Connecticut, 2004.

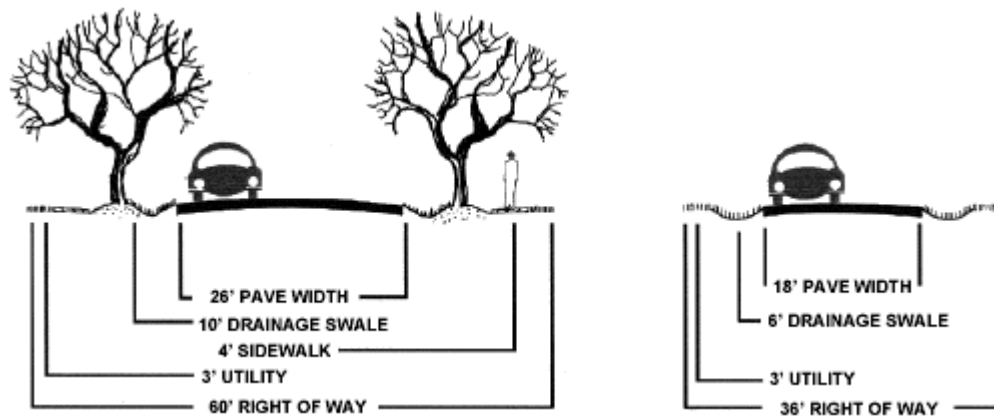

Figure 6.4.11 – Reduced road widths. Source: Atlanta Regional Commission, 2001.

## Use

Examine local ordinances and other requirements to determine standards and degree of flexibility available. Communities may have specific standards for setbacks and frontages or criteria for cul-de-sacs and other alternative turnarounds.

### *Reduce Roadway Lengths and Widths*

1. Consider site and road layouts that reduce overall street length.
2. Minimize street width by using narrower street designs as appropriate. Issues to consider include design speed, number of average daily trips (ADT), peak usage, need for on-street parking, sidewalks, design speed and right of way (see *Table 6.5* and *Figure 6.4.11*).

### *Reduce Surface Area of End-of-Street Turnarounds*

1. Consider types of vehicles that may need to access a street. Sufficient turnaround area is a significant factor to consider in the design of cul-de-sacs. Fire trucks, service vehicles and school buses are often cited as needing large turning radii. However, some fire trucks are designed for smaller turning radii. In addition, many newer large service vehicles are designed with a tri-axle (requiring a smaller turning radius) and school buses usually do not enter individual cul-de-sacs.
2. Minimize pavement at end-of-street turnarounds. Incorporate landscaped areas and consider alternatives to cul-de-sacs wherever practicable.

## Standards

### *Reduce Roadway Lengths and Widths*

The table below shows a recommended standard for five categories of street. *Table 6.5* is based on Table 35 of *Site Planning for Urban Stream Protection* (Schueler, 1995). Streets are categorized based on ADT and density of dwelling units (row 1 in the table).

**Table 6.5  
Roadway Design Standards for Five Street Types**

Design Factor	Lane	Access	Standard Street	Dense Street	Collector
<b>ADT</b>	Less than 100	100 - 500	500 - 1,000	100 - 1,000 @ 4 dwell units/acre	1,000 - 3,000
<b>Width (feet)</b>	16	20	26	32	22 - 28
<b>Extra ROW (feet)</b>	8 - 16	8 - 24	20	20	22 - 28
<b>Off-Street Parking</b>	None	One lane	One lane	Two lane	Emergency shoulders
<b>Drainage</b>	Swale	Swale or curb/gutter	Curb/gutter	Curb/gutter	Swale or shoulder
<b>Design Speed (MPH)</b>	15	20	25	25	25
<b>Sidewalks</b>	None	One side	One or two side	Two side	One side
<b>Frontage Lots</b>	Yes	Yes	Yes	Yes	No

Average Daily Trips

$$\text{ADT} = 10 \times \text{Number of Dwelling Units} \quad [7]$$

Peak Trips Per Hour

$$\text{Peak Trips/Hour} = \text{Number of Dwelling Units} \quad [8]$$

Please note that local zoning may supersede these recommendations. Although, these recommended standards are intended to account for safety and snow disposal, greater widths may be appropriate in some instances.

### *Reduce Surface Area of End-of-Street Turnarounds*

Wherever practicable cul-de-sac radii should be no more than 30 feet. Alternatives such as hammerheads, jug handles and donuts should also be considered.

## 6.4.3.2 Buildings

Imperviousness associated with buildings and accessories such as driveways can often be reduced with considerate planning in the early stages of site design. The techniques below should be considered and applied wherever practicable.

## Advantages

- Reduces the amount of impervious cover and associated runoff and pollutants generated.

## Discussion

### *Footprints*

The building footprint is the surface area of ground covered by structure. The impervious footprint of commercial buildings and residences can be reduced by using tall buildings. In comparison to single-story buildings, multistory buildings maintain floor area while covering less ground surface. Use alternate or taller building designs to reduce the impervious footprint of buildings. For example, in residential areas, consider colonial style homes instead of ranches.

### *Setbacks and Frontages*

Driveways generally extend from a roadway to a house. Therefore, driveway length is typically determined by building setback requirements. Driveways are noted to contribute up to 30 percent of impervious cover in residential areas (Schueler, 1995). Setback requirements of up to 75 feet are not uncommon. Notwithstanding, a driveway length of 20 to 30 feet is generally adequate to meet parking needs. A driveway width of 18 feet is generally adequate for parking two cars side-by-side.

Further, reducing side-yard widths and using narrower frontages can reduce total street length, especially important in cluster and open space designs. *Figure 6.4.12* shows residential examples of reduced front and side yard setbacks and narrow frontages.



Figure 6.4.12 – Reduced side yards and frontage at a development in Connecticut.

Flexible lot shapes and setback and frontage distances allow site designers to create attractive and unique lots that provide homeowners with enough space while allowing for the preservation of natural areas in a residential subdivision. *Figure 6.4.13* illustrates various nontraditional lot designs.

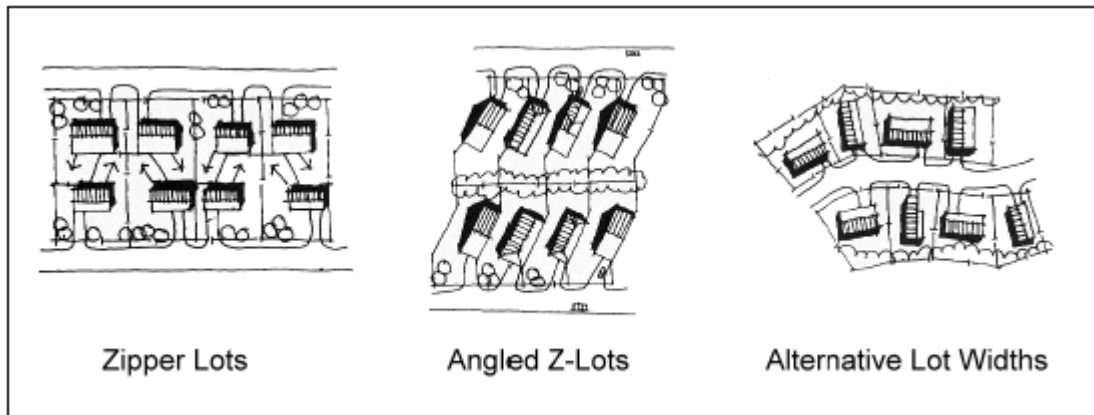

Figure 6.4.13 – Examples of nontraditional lot designs. Source: Adapted from Atlanta Regional Commission, 2001.

### Use

Use smaller front and side setbacks and narrower frontages to reduce total road length and driveway lengths.

Reduce building and home front and side setbacks to allow for narrow frontages. Consider narrower frontages.

- a) Consider alternative build styles that reduce ratio of footprint to floor area.
- b) Review local regulations. Communities may have specific design criteria for setbacks and frontages.
- c) Minimize setbacks and lot frontages.

### Standards

- a) Where practicable, reduce building setbacks to 20 - 30 feet and driveway widths to 18 feet.
- b) Where practicable, reduce frontages to 60 feet.

#### 6.4.3.3 Parking Footprints

Setting maximums for parking spaces, minimizing stall dimensions, using structured parking and encouraging shared parking and using alternative porous surfaces can reduce the overall parking footprint and site imperviousness.



## Advantages

- Reduces the amount of impervious cover and associated runoff and pollutants generated.

## Use and Standards

Apply the following approach:

Examine local ordinances and other requirements to determine standards and degree of flexibility available. Communities may have specific standards for parking stall size and number of parking spaces. There may also be prohibitions against shared parking.

### *Use Average Demand to Size Lots*

- Many parking lot designs result in far more spaces than actually required. This problem is exacerbated by a common practice of setting parking ratios to accommodate the highest hourly parking during the peak season. By determining average parking demand instead, a lower maximum number of parking spaces can be set to accommodate most of the demand.
- If no local standards require a minimum number of spaces, apply the standards in *Table 6.6* as a maximum number of spaces.

**Table 6.6**  
**Recommended Maximum Number of Parking Spaces for Certain Land Uses**

Land Use	Maximum Parking Spaces
Single Family House	2 per DU <sup>a</sup>
Shopping Center	5 per 1000 ft <sup>2</sup> GFA <sup>b</sup>
Convenience Store	3.3 per 1000 ft <sup>2</sup> GFA
Industrial	1 per 1000 ft <sup>2</sup> GFA
Medical Dental	5.7 per 1000 ft <sup>2</sup> GFA

Source: Georgia Stormwater Manual, 2002.

Notes:

<sup>a</sup> DU means dwelling unit.

<sup>b</sup> GFA means gross floor area.

Figure 6.4.14 – Parking deck – New Haven,

### *Minimize Parking Stall Size*

Another technique to reduce the parking footprint is to minimize the dimensions of the parking spaces. This can be accomplished by reducing both the length and width of the parking stall.

Parking stall dimensions can be further reduced if compact spaces are provided. While the trend toward larger sport utility vehicles (SUVs) is often cited as a barrier, stall width requirements in most local parking codes are much larger than the widest SUVs.



### *Use Parking Decks*

Structured parking decks can significantly reduce the overall parking footprint by minimizing surface parking. *Figure 5.14* shows a parking deck used for a commercial development.

### *Encourage Shared Parking*

Shared parking in mixed-use areas and structured parking are techniques that can further reduce the conversion of land to impervious cover. A shared parking arrangement could include usage of the same parking lot by an office space that experiences peak parking demand during the weekday with a church that experiences parking demands during the weekends and evenings.

## 6.4.3.4 Parking Lot Islands

A parking lot island is an area within a parking lot that includes one or more management practices and breaks up impervious surface (see *Figure 6.4.15*). Parking lot islands include small-scale management practices such as filter strips, dry swales, sand filters and bioretention.

### **Advantages**

- Reduces the amount of impervious cover and associated runoff and pollutants generated.
- Provides an opportunity for the siting of structural control facilities.
- Trees in parking lots provide shading for cars and are more visually appealing.

### **Use**

- Break up expanses of parking with landscaped islands, which include shade trees and shrubs.
- Fewer large islands will sustain healthy trees better than more numerous very small islands.



Figure 6.4.15 – Bioretention in use as a parking lot island in Branford, CT. Source: Connecticut Department of Environmental Protection.

Structural control facilities such as filter strips, dry swales and bioretention areas can be incorporated into parking lot islands. Stormwater is directed into these landscaped areas and temporarily detained. The runoff then flows through or filters down through the bed of the facility and is infiltrated into the subsurface or collected for discharge into a stream or another stormwater facility. These facilities can be attractively integrated into landscaped areas and can be maintained by commercial landscaping firms.

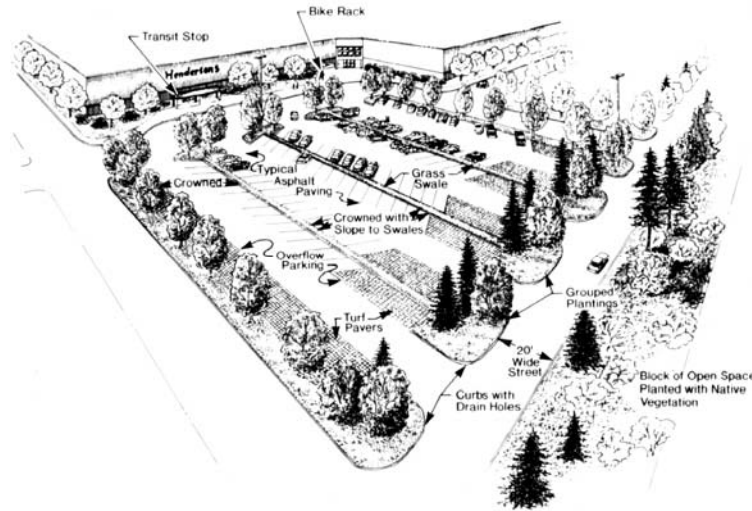

Figure 6.4.16 – Parking lot with islands attractively integrated. Source: Connecticut, 2004.

## Standards

Parking lot islands should:

- a) Be at least 8 feet wide.
- b) Be constructed with sub-surface drainage.
- c) Incorporate compaction resistant soil.

### 6.4.3.5 Permeable Pavement



Figure 6.4.17 – Permeable pavement. Source: Connecticut, 2004.

Permeable pavement is designed to allow rain and snowmelt to pass through it, thereby reducing runoff, promoting groundwater recharge, and filtering pollutants. Permeable paving materials include:

- Modular concrete paving blocks
- Modular concrete or plastic lattice
- Soil enhancement technologies
- Cast-in-place concrete grids
- Other materials such as gravel, Cobbles, wood, mulch, brick, and natural stone.

Porous asphalt or concrete (i.e., porous pavement or gap-graded pavement), which looks similar to traditional pavement but is manufactured without fine materials and incorporates additional void spaces, are only recommended for certain limited applications due to their potential for clogging and high failure rate in cold climates. Porous pavement is only recommended for sites that meet the following criteria:

- Low-traffic applications (generally 500 or fewer average daily trips or ADT).
- The underlying soils are sufficiently permeable (see Design Considerations below).
- Road sand is not applied.

Runoff from adjacent areas is directed away from the porous pavement by grading the surrounding landscape away from the site or by installing trenches to collect the runoff. Regular maintenance is performed (sweeping, vacuum cleaning).

## Advantages

- Reduces the amount of impervious cover and associated runoff and pollutants generated.
- Reduces the costs associated with road construction and maintenance.

## Use

- a) Applicable to small drainage areas.
- b) Low traffic (generally 500 ADT or less) areas of parking lots (i.e., overflow parking for malls and arenas), driveways for residential and light commercial use, walkways, bike paths, and patios.
- c) Roadside right-of-ways and emergency access lanes.
- d) Useful in stormwater retrofit applications where space is limited and where additional runoff control is required.
- e) In areas where snow plowing is not required.

## Standards

Chapter 11 of the current *Stormwater Quality Manual* includes specific design standards and considerations for permeable pavement. Update of these standards is beyond the scope of this technical memorandum.

### 6.4.3.6 Disconnecting Impervious Areas

Impervious surfaces that are separated from drainage collection systems by pervious surface or infiltrating BMPs contribute less runoff and reduced pollutant loading. Isolating impervious surface promotes infiltration and filtration of stormwater runoff.

#### Alternatives to Incorporate LID

Neither the *Guidelines for Soil Erosion and Sediment Control* nor the *Stormwater Quality Manual* include a specific design process or set of design standards for disconnection of impervious areas; however, such a discussion could be added to chapter 4 of the *Stormwater Quality Manual*.

## Advantages

- Promotes evapotranspiration and infiltration to reduce need for treatment and peak volume control at end-of-pipe.
- Reduces generation of stormwater.
- Maintains predevelopment hydrology, natural character and aesthetic features that may increase market value.

## Use

Use the following techniques to disconnect impervious surface from collection systems:

- a) Direct roof runoff and runoff from paved surfaces to stabilized vegetated areas such as buffers.
- b) Direct runoff from large impervious surfaces (over 5000 square feet) to more than one receiving area.

- c) Encourage sheet flow through vegetated areas.

## Standards

### General

- a) Disconnect impervious surfaces to the extent practicable.
- b) Up to the first inch of runoff from an impervious surface may be disconnected to a pervious surface such as a lawn.

**Table 6.7**  
**Ratio of Open Space: Pervious Area Necessary to Attenuate Surface Runoff**  
**for Runoff Between 0.5 and 1.0 Inches<sup>a, b</sup>**

Runoff (inches)	HSG Soil Type			
	A	B	C	D
1.0	1:2	4:1	N/A	N/A
0.9	1:3	2:1	N/A	N/A
0.8	1:4	1:1	N/A	N/A
0.7	1:8	1:2	N/A	N/A
0.6	1:8	1:3	2:1	N/A
0.5	1:8	1:6	1:1	N/A

Notes:

<sup>a</sup>Buffer size calculations based on TR-55. Calculations for precipitation depths less than 0.5 inches are not included as the empirical equations of TR-55 become less accurate for storms less than 0.5 inches.

<sup>b</sup>Standards for buffer width and length of contributing flow path, etc. must be met regardless of soil's capacity to attenuate flow.

- c) Relatively permeable soils (hydrologic soil groups A and B) must be present for disconnection. Assume that the pervious surface is open space in good condition (i.e., CN of 39 for HSG A and 61 for HSG B). (If a forested buffer is being used refer to "Preserving Natural Areas" for appropriate standards.) The following impervious to pervious area ratios should be used. Type C and D may not be used for this purpose as open space on these soil types does not abstract the rainfall required to generate one inch of runoff from the impervious surface.
- d) The maximum contributing impervious flow path length should be no more than 75 feet.
- e) The disconnected area should drain continuously through a vegetated channel, swale, or filter strip to the property line or structural stormwater control.
- f) Flow from the impervious surface must enter the downstream pervious area as sheet flow.
- g) The length of the disconnected area should be equal to or greater than the contributing length.
- h) The entire disconnected area should maintain a slope less than or equal to 5 percent.
- i) The surface of the contributing imperviousness area should not exceed 5,000 square feet.



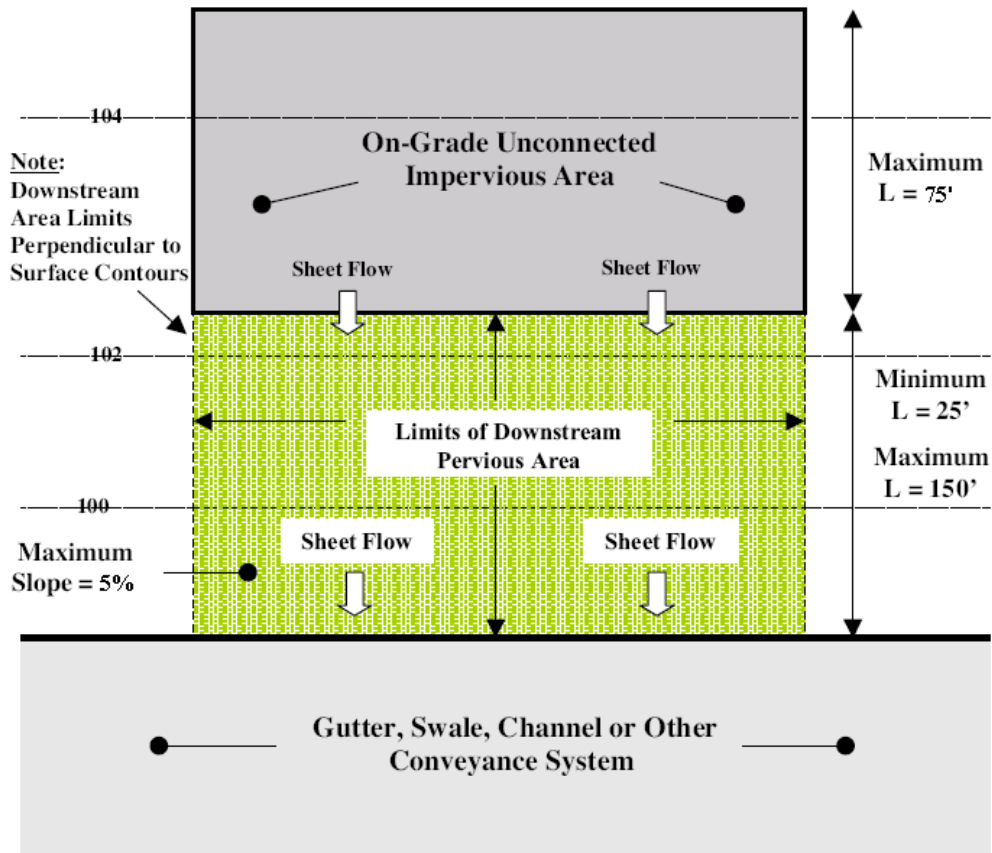

Figure 6.4.18 – Standards for disconnecting impervious surface via sheet flow. Source: New Jersey Department of Environmental Protection, 2004.

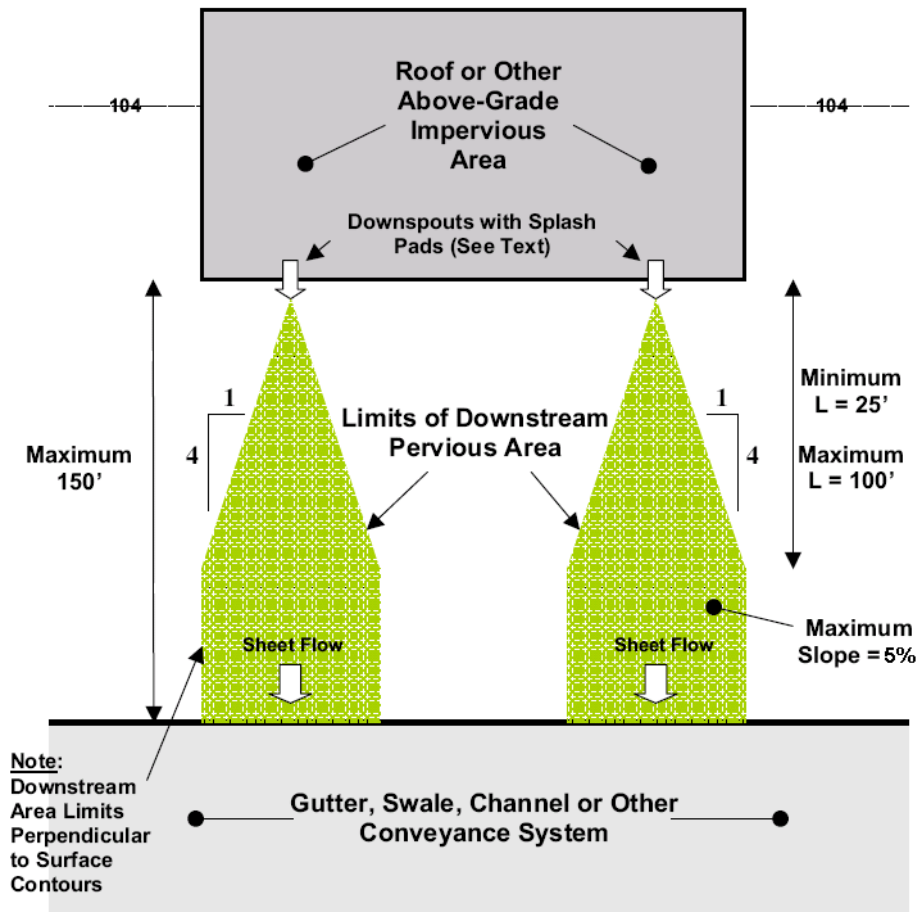

Figure 6.4.19 – Standards for disconnecting impervious surface via downspouts. Source: New Jersey Department of Environmental Protection, 2004.

### *Downspouts*

- Downspout outfall expands in width at a rate of 1:4 for a maximum length of 100 feet and a minimum length of 25 feet.
- No downspout may drain more than 600 square feet of roof.
- Downspouts should be at least 10 feet away from the nearest impervious surface (e.g., driveways) to discourage reconnections to those surfaces.
- Downspouts must be equipped with splash pads, level spreaders, or dispersion trenches that reduce flow velocity and induce sheet flow in the downstream pervious area.

## 6.4.4 Integrated Management Practices at the Source

### 6.4.4.1 Vegetated Filter Strips

A vegetated filter strip is an undisturbed densely vegetated area (e.g., well-tended lawn) contiguous with a developed area. These filter strips are most often located between a water resource and the developed portion of a site (see *Figure 6.4.20*).



Figure 6.4.20 – Vegetative filter strip. Source: Connecticut, 2004.

#### Advantages

Filter strips serve to improve runoff water quality, add or maintain wildlife habitat, and provide a screening effect for homeowners. This type of BMP is best suited for complementing other structural methods utilized on-site for stormwater management.

#### Use

Filter strips can be composed of an undisturbed-forested area or created from disturbed land by proper seeding and plantings. The most effective pollutant removal filter strip is composed of dense grass vegetation that is properly maintained

Channelization of runoff within the filter strip significantly reduces the amount of infiltration and subsequent pollutant removal. Filter strips must have a level-spreading device incorporated into the design. Caution must be used when installing level spreaders to ensure long-term even flow and distribution of runoff to the filter strip. See *Figure 5.5* for an example of a level spreader. Low volume pedestrian pathways may be constructed through a buffer strip, provided they are no greater than 4 feet wide and take a winding course to reduce the potential for channelized runoff flow. Pesticides should not be applied in these areas, although minimal, fertilizer use is acceptable to help seeded areas become more quickly established. Incorporating organic material, such as mulch, into the topsoil is encouraged to promote better filter strip performance.

Soils with a high content of organic material will attenuate greater amounts of pollutants from stormwater runoff.

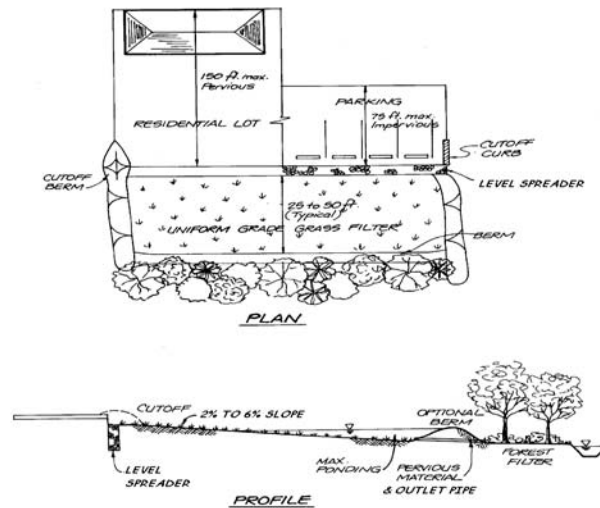

Figure 6.4.21 – Drawing of a vegetative filter strip. Source: Atlanta Regional Commission, 2001.

## Standards

Chapter 11 of the current *Stormwater Quality Manual* includes specific design standards and considerations for vegetative filter strips. Update of these standards is beyond the scope of this technical memorandum.

### 6.4.4.2 Natural and Vegetated Drainage Ways

Structural drainage systems and storm sewers are designed to be hydraulically efficient for removing stormwater from a site. However, in doing so these systems tend to increase peak runoff discharges, flow velocities and the delivery of pollutants to downstream waters. An alternative is the use of natural drainage ways such as grass natural drainage systems (see *Figure 6.4.22*).



Figures 6.4.22 – Vegetated drainage way. Photograph courtesy of the University of Connecticut NEMO program, Kara Bonsack

The use of natural open channels allows for more storage of stormwater flows on-site, lower stormwater peak flows, a reduction in erosive runoff velocities, infiltration of a portion of the runoff volume, and the capture and treatment of stormwater pollutants.

### Advantages

- Reduces or eliminates the cost of constructing storm sewers or other conveyances, and may reduce the need for land disturbance and grading.
- Increases travel times and lower peak discharges.
- Can be combined with buffer systems to enhance stormwater filtration and infiltration.

### Use

- a) Use vegetated open channels in the street right-of-way to convey and treat stormwater runoff from roadways, particularly for low-density development and residential subdivisions where density, topography, soils, slope, and safety issues permit.
- b) Use vegetated open channels in place of curb and gutter to convey and treat stormwater runoff.
- c) Design drainage systems and open channels to:
  - i. Increase surface roughness to retard velocity.
  - ii. Include wide and flat channels to reduce velocity of flow and encourage sheet flow if possible.
  - iii. Increase channel flow path to increase time of concentration and travel time.

### Standards

Chapter 11 of the current *Stormwater Quality Manual* includes specific design standards and considerations for grass drainage channels, which would provide appropriate standards for natural and vegetated drainage ways. Update of these standards is beyond the scope of this technical memorandum.

### 6.4.4.3 Green Roofs and Facades



Figure 6.4.23 – Aetna Building, Hartford, CT. Source: Connecticut Department of Environmental Protection.

#### Alternatives to Incorporate LID

Neither the *Guidelines for Soil Erosion and Sediment Control* nor the *Stormwater Quality Manual* currently include a detailed discussion of green roof and façade design. Such a discussion could be added to chapter 11 of the *Stormwater Quality Manual*. Green roofs are essentially a bioretention practice and could be added to the “filtration” BMPs. Ponding areas and façades should probably be included as a separate section of chapter 11 in the Manual.

Rooftop runoff management structures are modifications to conventional building design that retard runoff originating from roofs. The modifications include:

- Vegetated roof covers
- Roof gardens
- Vegetated building facades
- Roof ponding areas

Roofs are significant sources of concentrated runoff from developed sites. If runoff is controlled at the source, the size of other BMPs throughout the site can be minimal. Rooftop runoff management practices influence the runoff hydrograph in two ways:

- Intercept rainfall during the early part of a storm.
- Limit the maximum release rate.

In addition to achieving specific storm water runoff management objectives, rooftop runoff management can also be aesthetically and socially beneficial.



## Advantages

- Rooftop runoff management techniques can be retrofitted to most conventionally constructed buildings.
- Reduces energy consumption for heating and cooling.
- Conserves space.
- Reduces wear on roofs caused by UV damage, wind, and extremes of temperature. Vegetative roof covers can reduce bare roof temperatures in summer by as much as 40 percent.
- Roof gardens, vegetated roof covers, and vegetated facades add aesthetic value to residential and commercial property that attract songbirds, bees, and butterflies.
- Benefit water quality by reducing the acidity of runoff and trapping airborne particulates.
- May reduce the size of onsite runoff attenuation BMPs.

## Use

- a) Use vegetative roofs on residential, commercial and light industrial buildings.
- b) Vegetative roof systems are most appropriate on roofs with slopes of 12:1 to 4:1.
- c) Vegetative roofs may be used on flatter slopes if an underdrain is installed.

## Design Variations

- Vegetated roof cover – Vegetated roof covers, also called green roofs and extensive roof gardens, involve blanketing roofs with a veneer of living vegetation. Vegetative roof covers are particularly effective when applied to extensive roofs, such as those that typify commercial and institutional buildings. The filtering effect of vegetated roof covers results in a roof discharge that is free of leaves and roof litter. Therefore, it is recommended where roof runoff will be directed to infiltration devices (see Standards for Infiltration Practices and Dry Wells.)

Because of recent advances in synthetic drainage materials, vegetated covers now are feasible on most conventional flat roofs. An efficient drainage layer is placed between the growth media and the roof surface. This layer rapidly conveys water off of the roof surface and prevents water from “lying” on the roof. In fact, vegetated roof covers can be expected to protect roof materials and prolong their life.

If materials are selected carefully to reduce the weight of the system, vegetated roof covers generally can be created on existing flat roofs without additional structural support. Drainage nets or sheet drains constructed from lightweight synthetic materials can be used as underlayments to carry away water and prevent ponding. The total load of a fully vegetated and saturated roof cover system can be less than the design load computed for gravel ballast on conventional tar roofs.

Although vegetative roof covers are most effective during the growing season, they also are beneficial during the winter months as additional insulation if the vegetative matter from the dead or dormant plants is left in place and intact.

- Roof Gardens – Vegetated roof covers blanket an entire roof area and, although presenting an attractive vista, generally are not intended to accommodate routine traffic by people. Roof gardens, on the other hand, are landscaped environments, which may include planters and potted shrubs and trees. Roof gardens can be tailor-made natural areas, designed for outdoor recreation, and perched above congested city streets. Because of the special requirements for access, structural support, and drainage, roof gardens are found most frequently in new construction.

Roof gardens generally are designed to achieve specific architectural objectives. The load and hydraulic requirements for roof gardens will vary according to the intended use of the space. Intensive roof gardens typically include design elements such as planters filled with topsoil, decorative gravel or stone, and containers for trees and shrubs. Complete designs also may detain runoff ponding in the form of water gardens or storage in gravel beds. A wide range of hydrologic principles may be exploited to achieve storm water management objectives, including runoff peak attenuation and runoff volume control.

- Vegetated Building Facades – Vegetated facades provide many of the same benefits as vegetated roof covers and roof gardens, including the interception of precipitation and the retardation of runoff. However, their effectiveness is limited to small rainfall events.

Vertical facades and walls of houses can be covered with the foliage of self-climbing plants that are rooted in the ground and reach heights in excess of 80 feet. Vines can be evergreen or prolific deciduous flowering plants. As for roof gardens, the designer must be judicious in selecting plant species that will prosper in the constructed environment. Planters and trellises can be installed so that vegetation can be placed strategically.

- Roof Ponding – Roof ponding is applicable where the increased load of impounded water on a roof will not increase the building costs significantly or require extensive reinforcement. Roof ponding generally is not viable for large-area commercial buildings where clear spans are required. Special consideration must be given to ensuring that the roof will remain watertight under a range of adverse weather conditions. Low-cost plastic membranes can be used to construct an impermeable lining for the containment area.

Flat roofs can be converted to ponding areas by restricting the flow to downspouts. Even small ponding depths of 1 or 2 inches can attenuate storm water-runoff peaks effectively for most storms.

## Design Considerations

Rooftop measures are primarily peak runoff attenuation measures. The methods for evaluating the peak attenuation properties of these measures are based on approaches used for other peak

runoff attenuation BMPs. The emphasis of the design should be promoting rapid roof drainage and minimizing the weight of the system. By using appropriate materials, the total weight of fully saturated vegetated roof covers can readily be maintained below 20 pounds per square foot (psf). Because of the many factors that may influence the design of vegetated roof covers, it is advisable to obtain the services of installers that specialize in this area.

Rainfall retention properties are related to field capacity and wilting point. Appropriate media for this application should be capable of retaining water at the rate of 40 percent by weight, or greater. The media must be uniformly screened and blended to achieve its rainfall retention potential. During the early phases of a storm, the media and root systems of the cover will intercept and retain most of the rainfall, up to the retention capacity. For instance, 3-inch cover with 40 percent retention potential will effectively control the first 1.2 inches of rainfall. Although some water will percolate through the cover during this period, this quantity generally will be negligible compared to the direct runoff rate without the cover in place.

Once the field capacity of the cover is attained, water will drain freely through the media at a rate that is approximately equal to the saturated hydraulic conductivity for the media. Through the selection of the media, the maximum release rate from the roof can be controlled. The media is a mechanism for “buffering” or attenuating the peak runoff rates from roofed areas. Rooftop runoff management measures generally are more effective in controlling storms that generate 1 inch or less of runoff (i.e., 1.2-inch storm). However, because storms of this size constitute the majority of rainfall events, rooftop runoff measures can be important in planning for comprehensive storm water management. These measures are particularly useful when linked to groundwater recharge BMPs such as infiltration trenches, dry wells, and permeable pavements. By retaining rainfall for evaporation or plant transpiration, some rooftop runoff management measures, such as vegetated roof covers, can also achieve significant reductions in total annual runoff. This attenuation of runoff peaks from larger storms should be taken into account when sizing related runoff peak attenuation at the site.

By using specific information about the hydraulic properties of the cover media, the effect of the roof cover system on the runoff hydrograph can be approximated with numerical modeling techniques. As appropriate, the predicted hydrographs can be added into site-wide runoff models to evaluate the effect of the vegetative roof covers on site runoff. The hydraulic analysis of roof covers will require the services of a professional engineer who is experienced with drainage design.

### ***Impermeable Lining***

- a) In some instances, the impermeable lining can be the watertight tar surface, which is conventional for flat roof construction. However, where added protection is desired, a layer of plastic or rubber membrane can be installed immediately beneath the drainage net or sheet drain. This liner needs to be designed by a professional engineer to ensure proper function.
- b) If membranes are used, their resistance to ultraviolet (UV) radiation, extremes of temperature, and puncture must be known. In most cases, covering the sealing material with a protective layer of gravel or geotextile is advisable.

## *Drainage*

- a) The drainage net or sheet drain is a continuous layer that underlies the entire cover system. A variety of lightweight, high-performance drainage products will function well in this environment. The product selected should be capable of conveying the discharge associated with the runoff peak attenuation storm without ponding water on top of the roof cover. When evaluating a drainage layer design, the roof topography should be evaluated to establish where the longest travel distances to a roof gutter, drain, or downspout occur. If flow converges near drains and gutters, the design unit-flow rate should be increased accordingly.
- b) Drainage nets or sheet drains with transmissivities of 15 gallons per minute per foot, or larger, are recommended.
- c) The drainage layer should be able to convey the design unit flow rate at the roof grade without water ponding on top of the cover media. For larger storms, direct roof runoff is permitted to occur. The design flow rates should be based on the largest runoff peak attenuation design storm considered in the design.
- d) To prevent the growth media from penetrating and clogging the drainage layer and to prevent roots from penetrating the roof surface, a geotextile should be installed immediately over the drainage net or sheet drain. Many vendors will bond the geotextile to the upper surface of the drainage material.
- e) Effective roof garden designs will ensure that all direct rainfall is cycled through one or more devices before being discharged to downspouts as runoff. For instance, rainfall collected on a raised tile patio can be directed to a media-filled planter where some water is retained in the root zone and some is detained and gradually discharged through an overflow to the downspout.
- f) In the case of roof ponding, devices such as the one shown in *Figure 6.4.24*, are easily fabricated. However, some form of emergency overflow also is advisable. Emergency overflow can be as simple as a free overfall through a notch in the roof parapet wall.
- g) In roof ponding systems, because the roof is impermeable, the runoff hydrograph is simply the rainfall distribution for the design storm multiplied by the area of the roof.

The depth to storage relationship can be computed from the topography of the roof. For perfectly flat roofs, the storage volume of a ponding level is equal to the roof area times the ponding level. The depth-discharge relationship in will be unique to the outlet device used. For simple ponding rings on flat roofs, the discharge rate will approximately equal:

$$q = 3.141 CD (d - H)^{3/2}$$

Where:

- q = outflow rate
- C = discharge coefficient (Varies based on design) Typical: C = 3.0
- D = diameter of the ring
- d = depth of ponding
- H = height of the ring

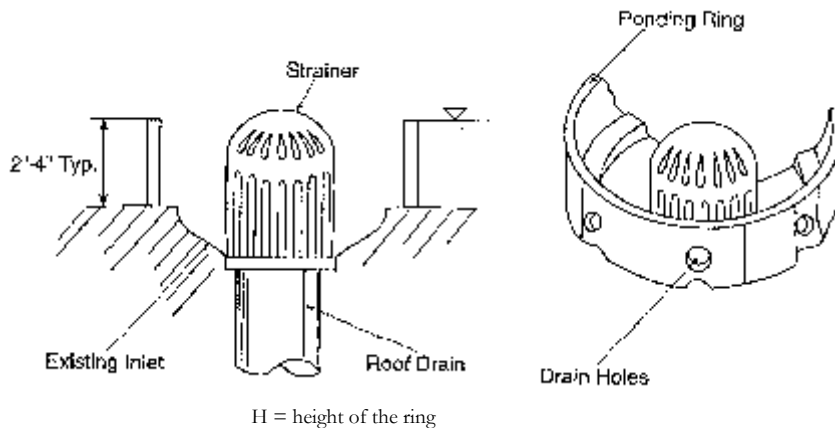

Figure 6.4.24 – Roof ponding rings. Source: Tourbier, 1974.

### ***Roof Loading***

The net weight of the fully vegetated roof cover should be compared against the design loads for the roof.

### ***Lightweight Growth Media***

- a) The depth of the growth media should be kept as small as the cover vegetation will allow. Typically, a depth of 3 to 4 inches will be sufficient. Low-density substrate materials with good water-retention capacity should be specified. Examples are mixtures containing crushed pumice and terra cotta. Media that are appropriate for this application will retain 40 to 60 percent water by weight and have bulk dry densities of between 35 and 50 lb/cubic foot. Earth and topsoil are too heavy for most applications.
- b) Hydrologic properties are specific to the growth medium. If the supplier does not provide information, prospective media should be laboratory tested to establish porosity, moisture content at field capacity, moisture content at the wilting point (nominally 0.33 bar), and saturated hydraulic conductivity.

### ***Adapted Plants and Grasses***

- a) A limited number of plants can thrive in the roof environment where periodic rainfall alternates with periods that are hot and dry. Effective plant species must:
  - i. Tolerate mildly acidic conditions and poor soil;
  - ii. Prefer very-well-drained conditions and full sun;
  - iii. Tolerate dry soil;
  - iv. Be vigorous colonizers.

Both annual and perennial plants can be used. Dozens of species have been successfully field-tested. Among these, some species of sedum (*Sedum*) have been shown to be particularly well adapted. Other candidates include hardy species of sedge (*Carex*), fescue (*Festuca*), feather grass (*Stipa*), and yarrow (*Achillea*).

- b) Vegetative roof covers may include provisions for occasional watering during extended dry periods. Conventional lawn sprinklers work well.
- c) The key to developing an effective vegetated facade is selecting plants that are well adapted to the conditions in which they must grow. For instance, depending on the location, plants may encounter shade or full sun. Plants that will provide thick foliage should be selected. Some plants with good climbing and foliage characteristics are ivy (*Hedera*), honeysuckle (*Lonicera*), wisteria (*Wisteria*), Virginia creeper (*Parthenocissus*), trumpet creeper (*Campsis*), and hardy cultivars of clematis (e.g., *Clematis paniculata*). Some of these plants will require a trellis or lattice to firmly support the vines.

### ***Inspection and Maintenance***

- a) Plans for water quality swales should identify detailed inspection and maintenance requirements, inspection and maintenance schedules, and those parties responsible for maintenance.
- b) All rooftop runoff management measures must be inspected and maintained periodically. Furthermore, the vegetative measures require the same normal care and maintenance that a planted area does. The maintenance includes attending to plant nutritional needs, irrigating as required during dry periods, and occasionally weeding.
- c) The cost of maintenance can be significantly reduced by judiciously selecting hardy plants that will outcompete weeds.
- d) In general, fertilizers must be applied periodically. Fertilizing usually is not a problem on flat or gently sloping roofs where access is unimpeded and fertilizers can be uniformly broadcast.
- e) Properly designed vegetated roof covers should not be damaged by treading on the cover system.



- f) When retrofitting existing roofs, preserve easy access to gutters, drains, spouts, and other components of the roof drainage system.
- g) It is good practice to thoroughly inspect the roof drainage system quarterly. Foreign matter, including leaves and litter, should be removed.

**Table 6.8  
Typical Maintenance Activities for Rooftop Runoff Structures**

Activity	Schedule
<ul style="list-style-type: none"> <li>• Inspect to ensure vegetative cover is established</li> <li>• Remove foreign matter, leaves, and litter</li> </ul>	Quarterly
<ul style="list-style-type: none"> <li>• Irrigate/Water</li> <li>• Weed</li> </ul>	As necessary
<ul style="list-style-type: none"> <li>• Apply fertilizers to flat or gently sloped roofs</li> </ul>	As necessary
<ul style="list-style-type: none"> <li>• Repair erosion on side slopes with seed or sod</li> </ul>	As necessary

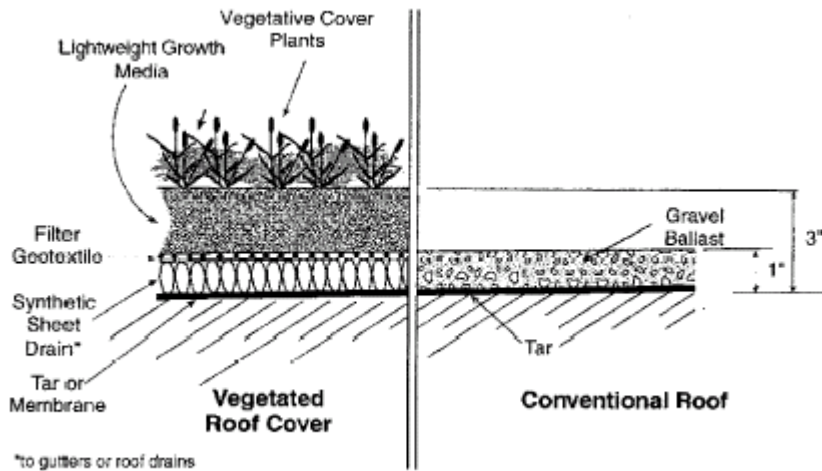

Figure 6.4.25 – Example Vegetated Rooftop Cross-section

#### 6.4.4.4 Rain Barrels and Cisterns

Rain barrels and cisterns are rainwater collection and storage devices (see *Figure 6.4.26*). They are generally low-cost and easily maintainable. They are applicable, for purposes of retrofit, to residential, commercial and industrial sites to manage rooftop runoff. Rain barrels and cisterns are not generally given stormwater management credit on new development.

Cisterns are generally larger than rain barrels, with some underground cisterns having the capacity of 10,000 gallons. Water collected in cisterns is typically used for irrigation or in some instances as a potable supply.



Figure 6.4.26 – Example of a rain barrel. Source: Connecticut Department of Environmental Protection.

#### Advantages

- Low cost.
- Applicable to a wide range of sites (e.g., residential, commercial industrial, etc.).
- Provide retention and detention of runoff from roofs.
- Can provide reuse of water for landscape irrigation.

#### Use

- a) Use rain barrels and cisterns in commercial, industrial and domestic settings.
- b) Incorporate rain barrels and cisterns when a building is being designed so that they can be blended into the landscape. They can also be retrofitted.

- c) Size rain barrels and cisterns based on roof area. The required capacity of a rain barrel is a function of the rooftop surface evaporative water losses and initial abstraction.

Rain barrel volume can be determined by calculating the roof top water yield for any given rainfall, using Equation 10. A general rule of thumb to utilize in the sizing of rain barrels is that 1 inch of rainfall on a 1000-square-foot roof will yield approximately 600 gallons.

$$V = A^2 \times R \times 0.90 \times 7.5 \text{ gals/ft}^3$$

where:

- $V$  = volume of rain barrel (gallons)
- $A^2$  = surface area roof (square feet)
- $R$  = rainfall (feet)
- 0.9 = losses to system (no units)
- 7.5 = conversion factor (gallons per cubic foot)

Example: one 60-gallon barrel would provide runoff storage from a rooftop area of approximately 215 square feet for a 0.5 inch (0.042 ft.) of rainfall.

$$60 \text{ gallons} = 215 \text{ ft.}^2 \times 0.042 \text{ ft.} \times 0.90 \times 7.5 \text{ gallons/ft.}^3$$

- d) If collected water will be used as a drinking source, the system will generally require local authority review and approval.
- e) Assure long-term function by establishing maintenance agreements.

## Standards

Chapter 4 of the current *Stormwater Quality Manual* includes specific design standards and considerations for rain barrels and cisterns. Update of these standards is beyond the scope of this technical memorandum.

### 6.4.4.5 Dry Wells

A dry well is a small, excavated pit, backfilled with stone aggregate. Dry wells function like infiltration systems to control roof runoff and are applicable for most types of buildings (see *Figure 6.4.27*).

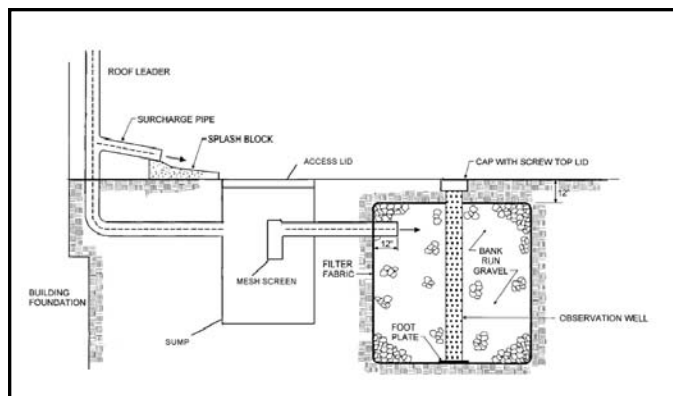

Figure 6.4.27 – Schematic of a drywell with optional sump to facilitate cleanout. Source: Adapted from New York, 2001.

## Advantages

- Low cost.
- Applicable to a wide range of sites (e.g., residential, commercial industrial, etc.).
- Provides retention of runoff from roofs.
- Recharges groundwater.
- Reduces need for end-of-pipe treatment.

## Use

- a) Dry wells can be useful for disposing of roof runoff and reducing the overall runoff volume from a variety of building sites.
- b) Infiltration of rooftop runoff from commercial or industrial buildings with pollution control, heating, cooling, or venting equipment may require UIC review and approval.

## Standards

Chapter 4 and 11 of the current *Stormwater Quality Manual* include specific design standards and considerations for dry wells. Update of these standards is beyond the scope of this technical memorandum.

### 6.4.4.6 Bioretention and Rain Gardens



Figure 6.4.28 – Bioretention at University of Connecticut Storrs Campus –Mansfield, CT. Source: Connecticut Department of Environmental Protection.

Bioretention and rain gardens are shallow landscaped depressions designed to manage and treat storm water runoff. Bioretention systems are a variation of a surface sand filter, where the sand filtration media is replaced with a planted soil bed designed to remove pollutants through physical and biological processes (EPA, 2002). The concept of bioretention originated with the Prince George's County, Maryland, Department of Environmental Resources in the early 1990s as an alternative to more traditional management practices. Storm water flows into the bioretention area, ponds on the surface, and gradually infiltrates into the soil bed. Treated water is allowed to infiltrate into the



surrounding soils or is collected by an underdrain system and discharged to the storm drain system or receiving waters. Small-scale bioretention applications (i.e., residential yards, median strips, parking lot islands) are commonly referred to as rain gardens (*Figure 6.4.29*).



Figure 6.4.29 – Rain garden.

### Advantages

- Applicable to small drainage areas, storm water retrofits and highly developed sites.
- Can be applied to most sites due to relatively few constraints and many design variations (i.e., highly versatile).
- High solids, metals, and bacteria removal efficiency.
- Infiltrating bioretention can provide groundwater recharge.
- Helps to mimic predevelopment runoff conditions.
- Reduces need for end-of-pipe treatment.

### Use

- a) Bioretention may be used in a wide variety of settings including residential, commercial, and industrial areas.
- b) May be decentralized (e.g., as rain gardens on individual lots) or centralized in common areas to manage multiple properties.
- c) May be lined and underdrained; or designed to infiltrate and recharge groundwater.

### Standards

Chapter 4 and 11 of the current *Stormwater Quality Manual* include specific design standards and considerations for bioretention. Update of these standards is beyond the scope of this technical memorandum.

#### 6.4.4.7 Infiltration Trenches

An infiltration trench is an excavated trench that has been back-filled with stone to form a subsurface basin. Stormwater runoff is diverted into the trench and is stored until it can be infiltrated into the soil, unusually over a period of 1 – 2 days.



Figure 6.4.30 – Infiltration trench.

## Advantages

- Applicable to small drainage areas, storm water retrofits and highly developed sites.
- High bacteria removal efficiency.
- Infiltration provides groundwater recharge.
- Helps to mimic predevelopment runoff conditions.
- Reduces need for end-of-pipe treatment.

## Use

- a) Infiltration may be useful for disposing of roof runoff (e.g., dry wells), or runoff from parking lots and roadways.
- b) Infiltration trenches generally have a longer life cycle when hydrologically preceded by pretreatment such as a vegetated filter strip.
- c) Infiltration generally requires UIC review and approval.

## Standards

Chapter 11 of the current *Stormwater Quality Manual* includes specific design standards and considerations for infiltration. Update of these standards is beyond the scope of this technical memorandum.

---

## 6.5 Overcoming Impediments to LID at the Local Level

Not infrequently, significant impediments to the implementation of LID can be found within existing regulation and code. Some examples include:

- Minimum parking space requirements.
- Unnecessarily wide roads.
- Requirements to include curb and gutter.
- Pavement type requirements that subvert use of pervious pavement.
- Requirements for sidewalks.
- Prohibition of open channel conveyance.
- Plumbing codes that prevent downspout disconnection.

The following discussion can be used as a starting point to help identify regulatory standards that may need adjustment to facilitate the implementation of LID. This was adapted from Appendix B of the *New Jersey Stormwater Best Management Practices Manual*:

[http://www.state.nj.us/dep/stormwater/bmp\\_manual/NJ\\_SWBMP\\_B.pdf](http://www.state.nj.us/dep/stormwater/bmp_manual/NJ_SWBMP_B.pdf)



## 6.5.1 Vegetation and Landscaping

Developing land in a way that mimics natural landscape is a key tenet of LID. Management of both existing and proposed site vegetation can affect groundwater recharge and stormwater runoff quality and quantity.

### 6.5.1.1 Preservation of Natural Areas

To properly incorporate LID municipal regulations should include requirements to preserve existing vegetated areas, minimize turf grass lawn areas, and use native vegetation.

- Are applicants required to provide a layout of the existing vegetated areas, and a description of the conditions in those areas?
- Does the municipality have maximum as well as minimum yard sizing ordinances?
- Are residents restricted from enlarging existing turf lawn areas?
- Do the ordinances provide incentives for the use of vegetation as filters for stormwater runoff?
- Do the ordinances require a specific percentage of permanently preserved open space as part of the evaluation of cluster development?

### 6.5.1.2 Tree Protection Ordinances

Municipalities often have tree ordinances designed to minimize the removal of trees and to replace trees that are removed. However, while tree ordinances protect the number of trees, they do not typically address the associated leaf litter or smaller vegetation that provides additional water quality and quantity benefits. The questions below are aimed at enhancing tree ordinances to incorporate the benefits of a forested area.

- Does the municipality have a tree protection ordinance?
- Can the municipality include a forest protection ordinance?
- If forested areas are present at development sites, is there a required percentage of the stand to be preserved?

### 6.5.1.3 Parking Lot Islands and Screening Ordinances

A parking lot island is a vegetated area within a parking lot that is designed to provide for groundwater recharge and, ideally, treatment of parking lot runoff. Parking lot islands can also provide for visual screening. Therefore, screening ordinances may provide an opportunity to incorporate LID and provide stormwater quality and groundwater recharge benefits.

- Do the ordinances require landscaping islands in parking lots, or between the roadway and the sidewalk? Can the ordinance be adjusted to require vegetation that is more beneficial for stormwater quality, groundwater recharge, or stormwater quantity, but that does not interfere with driver vision at the intersections?

- To what extent are bioretention islands and other stormwater practices within landscaped areas or setbacks allowed?
- Do the ordinances require screening from adjoining properties? Can the screening criteria require the use of vegetation to the maximum extent practicable before the use of walls or berms?

#### 6.5.1.4 Riparian Buffers

Many municipalities have buffer or floodplain policies that require the protection of vegetation adjacent to streams. The municipality should consider conservation restrictions and allowable maintenance to ensure the preservation of these areas.

- Is there a stream buffer or floodplain ordinance in the community?
- Does the ordinance require a conservation easement, or other permanent restrictions on buffer areas?
- Does the ordinance give detailed information on the type of maintenance and/or activities that are allowed in the buffer?

### 6.5.2 Minimizing Land Disturbance

A key goal of LID is to limit clearing, grading, and other disturbance associated with development. Limiting disturbance helps preserve the site's existing hydrologic character, as well as limiting the occurrence of soil compaction. Zoning ordinances may limit the amount of impervious surface on building lots, but may not limit the amount of area that can be disturbed during construction.

#### 6.5.2.1 Limits of Disturbance

Designing with the terrain, or site fingerprinting, requires an assessment of the characteristics of the site and the selection of areas for development that would minimize the impact. This can be incorporated into the requirements for existing site conditions and the environmental impact statement. Limits of disturbance should be incorporated into construction plans reviewed and approved by the municipality. Setbacks should be evaluated to determine whether they can be reduced.

- Does municipal policy require identification of environmentally critical and environmentally constrained areas?
- Are existing setbacks appropriate for desired LID practices?
- Does municipal policy incorporate maximum turf grass or impervious cover limits in setbacks?
- Do the ordinances inhibit or prohibit the clear cutting of the project site as part of the construction?
- Is the traffic of heavy construction vehicles limited to specific areas, such as areas of proposed roadway? Are these areas required to be identified on the plans and marked in the field?

- Do the ordinances require the identification of specific areas that provide significant hydrologic functions, such as existing surface storage areas, forested areas, riparian corridors, and areas with high groundwater recharge capabilities?
- Does the municipality require an as-built inspection before issuing a certificate of occupancy? If so, does the inspection include identification of compacted areas, if they exist within the site?
- Does the municipality require the restoration of compacted areas in accordance with the soil erosion and sediment control standards?

### 6.5.2.2 *Open Space and Cluster Development*

Since open space can have a variety of uses, municipalities should evaluate open space ordinances to determine whether amendments could provide for improved stormwater benefits.

- Are open-space or cluster development designs allowed in the municipality?
- Are flexible site design incentives available for developers that utilize open space or cluster design options?
- Are there limitations on the allowable disturbance of existing vegetated areas in open space?
- Are there requirements to re-establish vegetation in disturbed areas dedicated for open space?
- Is there a maximum allowable impervious cover in open space areas?

### 6.5.3 Impervious Area Management

The amount of impervious area, and its relationship to adjacent vegetated areas, can significantly change the amount of runoff that needs treatment. A large fraction of a developed site's impervious surfaces is located in its streets, sidewalks, driveway, and parking areas. Continuous curb requirements may prevent runoff from reaching adjacent vegetated areas.

#### 6.5.3.1 *Streets and Driveways*

Street widths of 18 to 22 feet are recommended for low impact development designs in low density residential developments. Maximum driveway widths of 9 and 18 feet for one lane and two lanes, respectively, are also recommended. Width requirements of all streets and driveways should be evaluated to demonstrate that the proposed width is the narrowest possible consistent with safety and traffic concerns and requirements. Municipalities should evaluate which traffic calming features, such as circles, rotaries, medians, and islands, can be vegetated or landscaped. Cul-de-sacs can also be evaluated to reduce the radius area, or to provide a landscape island in the center.

- Do street designs vary by type (e.g., artery, collector, neighborhood) and context (e.g., suburban area, urban core, etc.)

- Are the street widths the minimum and maximum necessary for traffic density, emergency vehicle movement, and roadside parking while supporting pedestrian use and safety?
- Are street features, such as circles, rotaries, or landscaped islands allowed to or required to receive runoff?
- Are curb cuts or flush curbs with curb stops an allowable alternative to raised curbs?
- Can the minimum cul-de-sac radius be reduced or is a landscaped island required in the center of the cul-de-sac?
- Are alternative turn-arounds such as “hammerheads” allowed on short streets in low density residential developments?
- Can the minimum driveway width be reduced?
- Are shared driveways permitted in residential developments?

### 6.5.3.2 *Parking Areas and Sidewalks*

A mix of uses at a development site can allow for shared parking areas, reducing the total parking area. Municipalities require minimum parking areas, but seldom limit the total number of parking spaces.

- Can the parking ratios be reduced?
- Are the parking requirements set as maximum or median rather than minimum requirements?
- Is the use of shared parking arrangements allowed to reduce the parking area?
- Are model shared parking agreements provided?
- Does the presence of mass transit allow for reduced parking ratios?
- Is a minimum stall width of 9 feet allowed?
- Is a minimum stall length of 18 feet allowed?
- Can the stall lengths be reduced to allow vehicle overhang into a vegetated area?
- Do ordinances allow for permeable material to be used in overflow parking areas?
- Are there incentives to provide parking that reduces impervious cover, rather than providing only surface parking lots?

*Sidewalks can be made of pervious material or disconnected from the drainage system to allow runoff to re-infiltrate into the adjacent pervious areas.*

- Do ordinances allow for sidewalks constructed with pervious material?
- Can alternate pedestrian networks be substituted for sidewalks (e.g., trails through common areas)?

### 6.5.3.3 *Unconnected Impervious Areas*

Disconnection of impervious areas can occur in both low density development and high density commercial development, provided sufficient vegetated area is available to accept dispersed stormwater flows. Areas for disconnection include parking lot or cul-de-sac islands, lawn areas, and other vegetated areas.

- Are developers required to disconnect impervious surfaces to promote pollutant removal and groundwater recharge?
- Do ordinances allow the reduction of the runoff volume when runoff from impervious areas is re-infiltrated into vegetated areas?
- Do ordinances allow flush curb and/or curb cuts to allow for runoff to discharge into adjacent vegetated areas as sheet flow?

## 6.5.4 Vegetated Open Channels

The use of vegetated channels, rather than the standard concrete curb and gutter configuration, can decrease flow velocity, and allow for stormwater filtration and re-infiltration. One design option is for vegetated channels that convey smaller storm events, such as the water quality design storm, and provide an overflow into a storm sewer system for larger storm events.

- Do ordinances allow or require vegetated open channel conveyance instead of the standard curb and gutter designs?
- Are there established design criteria for vegetated channels?

## 7 Results and Next Steps

The Partners have been actively involved in strategic planning and implementation through the Low Impact Development and Stormwater General Permit Evaluation project. It is anticipated that the Partners will wish to continue to participate actively in implementation of the alternatives that they selected.

As previously discussed in *Section 5.2.1 and Section 5.3.3*, alternatives were categorized into groups by type of implementation approach. These alternatives are referenced throughout and listed below.

- Regulatory
  - Update the Manual/Guidelines
    - Standalone LID update
    - Appendix to the Manual/Guidelines
    - Direct incorporation into the SGP
  - Incorporating Standards into the SGP
    - Reference the Manual/Guidelines in the SGP as requirement
    - Reference the Manual/Guidelines in the SGP as guidance
    - Write specific standards from the Manual/Guidelines into the SGP
  - Designer licensing
  - Impervious surface cap and trade
  - Adjusted standards for areas of special concern
- Nonregulatory
  - Training program

- Financial incentives
- Technical assistance
- Public education
  
- Stormwater Utility Districts
  - Stormwater Utility Subcommittee
  - Guidance document
  - Technical and financial assistance program
  - Public outreach and awareness toolbox
  - Delegation of regulatory authority
  
- Hybrid Option
  
- LID certification/award
  
- Municipal Certification

---

## 7.1 Results

Dot voting during Partner Workshop 3 (*Section 5.3.3*) provided the following general results:

- Alternatives with one or more of the two highest vote tallies under a criterion are generally one of the five alternatives with the highest total number of votes. This indicates that Connecticut can probably achieve a relatively balanced LID implementation approach by working on the alternatives receiving the most total votes. For example, if Connecticut implements a nonregulatory LID program that includes a combination of training, technical assistance, and public education, the top-three rated alternatives would be addressed and the top vote getters for the criteria “knowledge-based, behavior change,” “practicable and flexible,” and “environmentally beneficial” would also be included.
  
- Based on “Table 5.1 Summary of General Alternatives and Criteria for Decision Making,” (*Section 5.2.3*) the strengths, benefits, weaknesses, and dangers associated with nonregulatory programs make a nice compliment to regulatory programs. That is to say, regulatory alternatives are viewed as having strengths under the criteria of “clear and understandable,” “administrable,” and “environmentally beneficial”; while nonregulatory alternatives were viewed as having strengths and benefits under the criteria of “economically viable” and “practicable and flexible.” A combination of regulatory and nonregulatory alternatives; therefore, provides strengths and benefits under the criteria of “clear and understandable,” “administrable,” “environmentally beneficial,” “economically viable,” and “practicable and flexible.”
  
- The criteria of “administrable” and “environmentally beneficial” received the fewest total votes. “Administrable” received the lowest number with 18 total votes. This does not necessarily mean that the alternatives available are neither readily administrable nor



particularly environmentally beneficial; however, exploring this issue might be instructive.

### 7.1.1 Regulatory Programs

Dot voting during Partner Workshop 3 (*Section 5.3.3*) provided the following results pertaining to regulatory programs:

- If desired, “adjusted standards for areas of special concern” could be incorporated with the “update of the manual/guidelines” and/or “incorporating standards into the SGP.” DEP has decided to pursue both of these alternatives as part of this project.
- The two alternatives receiving the fewest votes were “impervious surface cap and trade” and “delegation of regulatory authority.” These alternatives should probably be set aside for the time being.

### 7.1.2 Nonregulatory Programs

Dot voting during Partner Workshop 3 (*Section 5.3.3*) provided the following results pertaining to nonregulatory programs:

- Nonregulatory alternatives (e.g., training, technical assistance, and public education) tended to receive more votes than alternatives in the regulatory or stormwater utility categories. This would indicate that the Partners as a group desire to see training early in the LID implementation process.
- Although the “LID certificate/award” and “municipal certificates” were not among the top total vote getters, they are also newly developed alternatives and have yet to be fully vetted. “Municipal certificates” received the second highest score under the “knowledge-based, behavior change” criterion.
- The “training” alternatives within the nonregulatory alternatives scored highly under “knowledge-based, behavioral change” and “clear and understandable”; while public education scored highly under “clear and understandable”; and “technical assistance” scored highly under “practicable and flexible.” If the partners decide to pursue nonregulatory alternatives, a combination of these three alternatives would probably provide the most balanced approach.
- The only alternatives that scored well for “economically viable” were the “stormwater utility subcommittee” and “financial incentives.” Including one or more of these alternatives, even though they did not score well overall, may help to provide a more rounded approach to LID implementation.

### 7.1.3 Stormwater Utility Districts

Dot voting during Partner Workshop 3 (*Section 5.3.3*) indicated that development of a stormwater utility “guidance document” was one of the five top-rated alternatives. Development of stormwater utility enabling legislation would probably be necessary to make the stormwater utility guidance document meaningful.

Partner interviews and the Workshop 2 exercises (*Section 4.4*) indicated there is generally a broad range of perceived positive and negative aspects associated with stormwater utility districts. More specific results follow:

- Based on the interviews, there is an approximately even split on whether stormwater utilities should be used as regulatory devices; however, interviewee responses lean somewhat against the idea or unsure about it.
- A significant percentage of interviewees think stormwater utility district implementation is politically unlikely.
- Existing regional authorities, such as the MDC, were suggested as an implementing agency. If enabling authority to implement exists in regional agencies, this would overcome the issue of uncertain enabling authority at the municipal level. It may also sidestep some of the political concerns.
- Certain aspects of stormwater utility districts present contrarily as both strengths and weaknesses. For example:
  - “Watershed based” is listed as, a strength while “regionalization” is listed as a weakness.
  - “Removes stormwater from politics” is listed as, a strength while “political conflicts” is listed as a weakness.
  - “Raises revenue” is listed as a benefit while “public perception—tax” is listed as a danger.
- Several yet-to-be-answered questions were raised about stormwater utility districts during the workshops:
  - How do we measure success?
  - Who sets stormwater fees and how?
  - Are they [stormwater utility districts] to be voluntary or required?

#### *Issues to Review*

Despite their benefits stormwater utility districts are not viable in every political and administrative circumstance. *Table 4.2* in *Section 4.2.2* of this report lists a series of issues to review when considering whether or not stormwater utility districts make sense. Through

interviews and workshops, the partners on this project have essentially identified four of these as significant concerns:

- Political acceptance—Questions exist as to the political likelihood of being able to pass stormwater utility district ordinances at the local level.
- Legal structure—Analysis by OLR and analysis done for Public Act 7-154 grants indicates that the legal structure does not currently support regional stormwater utility districts and may not support individual municipal stormwater utility districts.
- Equity—Questions exist as to how a fee-setting structure would be implemented.
- Bureaucracy—A number of partners have expressed concern that municipal stormwater utility districts will add bureaucracy and “new layers” of government.

---

## 7.2 Next Steps

The following subsections identify additional next steps related to implementation of regulatory programs, nonregulatory programs, and storm water utility districts. Each of the items in Sections 7.2.1 – 7.2.3 was identified as a priority item during Workshop 3 (see Table 5.2).

### 7.2.1 Regulatory Programs

Generally, DEP intends to develop a LID guidance for inclusion as an appendix to the existing Stormwater Quality Manual and Soil Erosion and Sediment Control Guideline, initiating in winter 2011. Further, DEP anticipates developing a full update to the *Stormwater Quality Manual* and *Soil Erosion and Sediment Control Guideline*.

As part of the LID guidance, DEP intends to develop adjusted standards for areas of special concern. These standards will be incorporated into an updated stormwater manual/guidelines and will also be incorporated into the SGPs.

A number of states include flexibility in their stormwater management standards to address atypical circumstances. In some cases, adjusted standards are intended to be more highly protective of sensitive resources. In other cases, the standards are relaxed to encourage infill development or to reduce the burden of stormwater management in areas where it yields diminishing return. Some examples of adjusted management standards include:

- Standards designed to achieve pollutant load reductions for impaired water resources.
- Nitrogen management requirements for nitrogen-sensitive resources such as Long Island Sound or drinking water aquifers.
- Relaxed impervious cover allowances in highly urbanized settings.
- Graduated recharge requirements based on hydrologic soil group.

As a next step, DEP may wish to establish adjusted management standards for areas of special concern.

## 7.2.2 Nonregulatory Programs

During the selection of alternatives, documented in Workshop 3 the partners identified several nonregulatory alternatives as priorities for implementation. These included:

- Training programs
- Technical assistance
- Public education

Details for implementation have yet to be developed; however, general descriptions of such elements adapted from *Section 5* are provided below:

### *Training Program*

A training program for professionals (e.g., designers and installers) and officials could be voluntary or mandatory and, therefore, could be considered as either a regulatory or nonregulatory approach. Training could be provided on an *ad hoc* basis through occasional workshops and conferences. Training could also be structured into a series of classes, curriculum, certification, or licensure with a continuing education requirement. Target audiences are those within the regulated community. A grant or other financial allocation could be used to develop a training program or educational series. Training program development may best be run through a college or university as such institutions already possess many of the resources needed to implement and assess the cost-benefit of a training program.

### *Technical Assistance*

Technical assistance could take the form of assistance in policy review and analysis, support in developing technical standards through research projects, educational and training programs, BMP demonstrations, and experts-on-hand for questions. For maximum benefit, technical assistance could be coupled with guidance materials and financial assistance.

### *Public Education*

For effective implementation of LID to take place, members of the regulated community (i.e., designers and installers), government, and landowners (consumers) must all cooperate. The regulated community must provide proper design and installation services. Government must provide an appropriate regulatory framework. Consumers must demand quality goods and services and must properly operate and maintain installed BMPs. Consumers will need to be made aware of their role and then behave according to it. Public education is, therefore, important to raise awareness of the consumer (general) public. Public education may take a variety of forms:

- Fact sheets and brochures
- Public service announcements
- Workshops and classes

- Grassroots outreach

Education may also be provided through a variety of outlets:

- Government agencies
- Service providers
- Nongovernmental organizations
- Educational institutions

A public education program could be developed to work through a variety of forms and media and could be delivered through a variety of outlets. Stormwater public education programs have been developed for a number of states and cities. San Diego's Think Blue Program for stormwater—which includes public service announcements, an adaptable program template, and measurement of behavior change—makes a good example. Similar approaches could be created for LID and could be structured to include behavior-change elements and measurement.

### 7.2.3 Stormwater Utility Districts

During Workshop 3, development of a stormwater utility guidance document was identified as a priority for implementation. Development of a stormwater utility guidance document was described in *Section 5.1.1.3.2* of this report as follows:

Prior to pursuing stormwater utility districts at any governmental level, an approach to fee-setting and bureaucratic structure should be considered. It may be helpful to develop a model stormwater utility district ordinance and guidance manual for utility district development and implementation in Connecticut.

This discussion also points out that:

To ensure usefulness, guidance materials should be vetted through a test group of likely users of the guidance document. A subcommittee, such as the one described in *Section 2.1.4.1*, would make a good test group.

A description of this subcommittee is provided in *Section 5.1.1.3.1* of this Final Report. It states:

Implementation of stormwater utility districts in Connecticut will necessitate development of significant new policy, programs, and administrative structures. To make new policy, programs, and administrative structures efficient and service oriented, proponents from different levels of government and interested municipalities may wish to meet in a subcommittee to identify opportunities to cooperate in developing common approaches.

Also as discussed in *Section 5.3.4*:

Development of a stormwater utility “guidance document” was one of the five top-rated alternatives. Development of stormwater utility enabling legislation would probably be necessary to make the stormwater utility guidance document meaningful.

Therefore, this report recommends that if a stormwater utility guidance document is pursued that it should be developed in conjunction with enabling legislation and in the context of a subcommittee.

### 7.3 Recommended Schedule

The following table presents a proposed schedule for completing the action items identified throughout *Section 7.2*.

Action Item	Approximate Completion Timeframe
<b>Regulatory</b>	
<ul style="list-style-type: none"> <li>• Develop a LID guidance for inclusion as an appendix to the existing Stormwater Quality Manual and Soil Erosion and Sediment Control Guideline.</li> </ul>	March 2011
<ul style="list-style-type: none"> <li>• Step 2—Develop a Full update to the <i>Stormwater Quality Manual</i> and <i>Soil Erosion and Sediment Control Guideline</i>.</li> </ul>	2014
<ul style="list-style-type: none"> <li>• Establish adjusted management standards for areas of special concern.</li> </ul>	March 2011
<b>Nonregulatory</b>	
<ul style="list-style-type: none"> <li>• Develop a program to provide training, technical assistance, and public education for implementing LID alternatives.</li> </ul>	TBD
<ul style="list-style-type: none"> <li>○ Training programs</li> </ul>	TBD
<ul style="list-style-type: none"> <li>○ Technical assistance program</li> </ul>	TBD
<ul style="list-style-type: none"> <li>○ Public education</li> </ul>	TBD
<b>Stormwater Utilities</b>	
<ul style="list-style-type: none"> <li>• Conduct legal research to determine legal feasibility of establishing stormwater utility districts through existing regional authorities such as water utilities, wastewater authorities, fire districts, etc.</li> </ul>	TBD
<ul style="list-style-type: none"> <li>• Establish a subcommittee to oversee development of enabling legislation and a stormwater utility district guidance document.</li> </ul>	TBD
<ul style="list-style-type: none"> <li>• Draft stormwater utility district enabling legislation</li> </ul>	TBD
<ul style="list-style-type: none"> <li>• Develop a model stormwater utility district ordinance and guidance manual for utility district development and implementation in Connecticut.</li> </ul>	TBD
<ul style="list-style-type: none"> <li>○ Establish fee setting structure.</li> </ul>	TBD
<ul style="list-style-type: none"> <li>○ Establish bureaucratic and administrative structure.</li> </ul>	TBD
<ul style="list-style-type: none"> <li>○ Establish process to build public understanding and acceptance.</li> </ul>	TBD



## 8 References

Atlantic Regional Commission (ARC). 2001. *Georgia Stormwater Management Manual*. [No municipality of publication].

Bobrowski, Mark and Teitz, Andrew. 2001. *Model Land Use Ordinances*. Providence, RI.

Burton, G.A., & R.E. Pitt, 2002. *Stormwater Effects Handbook. A Toolbox for Watershed Managers, Scientists, and Engineers*. Lewis Publishers. New York, NY.

Center for Watershed Protection (CWP). 2000. *The Practice of Watershed Protection*. Ellicott City, Maryland.

Center for Watershed Protection (CWP). 1996. *Review Draft: Pollutant Removal Database of Current Urban Stormwater Best Management Practices*. Silver Spring, Maryland.

Center for Watershed Protection (CWP). [no publication date]. *Better Site Design: An Assessment of the Better Site Design Principles for Communities Implementing Virginia's Chesapeake Bay Preservation Act*. Ellicott City, Maryland.

Center for Watershed Protection (CWP). 2000. *Better Site Design: A Handbook for Changing Development Rules in Your Community*. Ellicott City, Maryland.

Center for Watershed Protection (CWP). 2002. *Vermont Stormwater Management Manual. Vermont Agency of Natural Resources*. Waterbury, VT.

Center for Watershed Protection (CWP). [no publication date]. Better Site Design Fact Sheet: Narrower Residential Streets. [http://www.stormwatercenter.net/Assorted%20Fact%20Sheets/Tool4\\_Site\\_Design/narrow\\_streets.htm](http://www.stormwatercenter.net/Assorted%20Fact%20Sheets/Tool4_Site_Design/narrow_streets.htm)

Connecticut Department of Environmental Protection (DEP). 1995. *Connecticut Stormwater Quality Manual (draft)*. Bureau of Water Management. Planning and Standards Division. Hartford, Connecticut.

Connecticut Department of Environmental Protection (DEP). 1995. *Connecticut Stormwater Quality Planning: A Guide for Municipal Officials and Regional Planners (draft)*. Bureau of Water Management. Planning and Standards Division. Hartford, Connecticut.

Cyre, Hector J. (1982). "Stormwater Management Financing." *Houston: American Public Works Association*.

Cyre, Hector J. (1983). "New Options for Stormwater Financing." *APWA Reporter*. Houston: American Public Works Association.

- Frisman, Paul. (2004). *"Storm Water Utilities."* Hartford: Office of Legal Research.
- Malcolm Pirnie. (Interim Draft 2009). *Stormwater Pilot Program Interim Report*. White Planes: Author.
- Gibbons, Jim. 1999. Nonpoint Source Education for Municipal Officials: Roads. [http://www.nemo.uconn.edu/publications/tech\\_papers/tech\\_paper\\_9.pdf](http://www.nemo.uconn.edu/publications/tech_papers/tech_paper_9.pdf)
- Horsley and Whitten. [No publication date]. *Urban Stormwater Planning Handbook: A Survey of Innovative Structural Stormwater Best Management Practices*. [No municipality of publication].
- Institute of Transportation Engineers (ITE). 1987. Parking Generation. 2<sup>nd</sup> Edition. Institute of Transportation Engineers, Washington, DC. 220 pp.
- Metropolitan Council. 2001. *Minnesota Urban Small Sites BMP Manual: Stormwater Best Management Practices for Cold Climates*. Prepared by Barr Engineering Company. St. Paul, Minnesota.
- Metropolitan Council Environmental Services. 2003. *Urban Small Sites Best Management Practice Manual*. <http://www.metrocouncil.org/environment/Watershed/bmp/manual.htm>
- Milone & MacBroom, Inc. (2005). *Stormwater Utility Feasibility Study, Stonington, Connecticut*. Cheschire: Author.
- Milwaukee River Basin Partnership. [no publication date]. Protecting Our Waters: Streets and Roads. <http://clean-water.uwex.edu/plan/streetsroads.htm>
- Municipal Stormwater Authority Pilot Program, Public Act 7-154 (2007)*.
- Natural Resources Defense Council (NRDC). 1999. *Stormwater Strategies: Community Responses to Runoff Pollution*.
- New Jersey Department of Environmental Protection (NJDEP). 2000. *Revised Manual for New Jersey: Best Management Practices for Control of Nonpoint Source Pollution from Stormwater*, Fifth Draft, May 3, 2000.
- New York State Department of Environmental Conservation (NYDEC). 2001. *New York State Stormwater Management Design Manual*. Prepared by Center for Watershed Protection. Albany, New York.
- Nonpoint Education for Municipal Officials (NEMO) website, URL: <http://nemo.uconn.edu>.
- Pennsylvania Association of Conservation Districts, Keystone Chapter Soil and Water Conservation Society, Pennsylvania Department of Environmental Protection, and Natural Resources Conservation Service. 1998. *Pennsylvania Handbook of Best Management Practices for Developing Areas*. Prepared by CH2MHILL.
- Pitt, R. 1999. Department of Civil and Environmental Engineering, University of Alabama at Birmingham.

Prince Georges County, Maryland, Department of Environmental Resources (PGDER), 1999. *Low-Impact Development Design Strategies, An Integrated Design Approach*. Prince Georges County, Maryland.

Pudget Sound Action Team. 2003. *Natural Approaches to Stormwater Management: Low Impact Development in Pudget Sound*. Olympia, WA.

Rhode Island Department of Environmental Management (RIDEM). 1993. *State of Rhode Island, Stormwater Design and Installation Standards Manual*. Providence, RI.

Schueler, Tom. 1995. *Environmental Land Planning Series: Site Planning for Urban Stream Protection*. Silver Spring, MD.

Schueler, T.R., Kumble, P.A., and M.A. Heraty. 1992. *A Current Assessment of Urban Best Management Practices: Techniques for Reducing Non-Point Source Pollution in the Coastal Zone*. Department of Environmental Programs. Metropolitan Washington Council of Governments.

Schueler, T.R. 1994. "The Importance of Imperviousness". *Watershed Protection Techniques*. Vol. 1, No. 3.

Schueler, T.R. 1995. *Site Planning for Urban Stream Protection*. Metropolitan Washington Council of Governments. Washington, D.C.

Schueler, T.R. 1999. "Microbes and Urban Watersheds". *Watershed Protection Techniques*. Vol. 3, No. 1.

Schueler, T.R., Kumble, P.A., and M.A. Heraty. 1992. *A Current Assessment of Urban Best Management Practices: Techniques for Reducing Non-Point Source Pollution in the Coastal Zone*. Department of Environmental Programs, Metropolitan Washington Council of Governments.

Seattle Public Utilities District. 2003. Street Edge Alternatives (SEA Streets) Project. [http://www.seattle.gov/util/About\\_SPU/Drainage\\_&\\_Sewer\\_System/Natural\\_Drainage\\_Systems/Street\\_Edge\\_Alternatives/index.asp](http://www.seattle.gov/util/About_SPU/Drainage_&_Sewer_System/Natural_Drainage_Systems/Street_Edge_Alternatives/index.asp)

Soil Conservation Service. 1986. *Urban Hydrology for Small Watersheds, USDA Soil Conservation Service Technical Release No. 55*. Washington, D.C.

Stahre, Peter and Urbonas, Ben. 1990. *Stormwater Detention For Drainage, Water Quality, and CSO Management*. Prentice Hall: Englewood Cliffs, NJ.

Traintor, Frederick F. 2001 *Farming and Forestry Strategies*. Providence, RI.

Treadway, Elizabeth and Reese, Andrew. (2000). "Financial Strategies for Stormwater Management." *APWA Reporter*. Houston: American Public Works Association.

United States Environmental Protection Agency (EPA), 2002. *National Management Measures to Control Nonpoint Source Pollution from Urban Areas (Draft)*. Washington, D.C.

United States Environmental Protection Agency (EPA). 1983. *Results of the Nationwide Urban Runoff Program, Volume 1, Final Report*. Water Planning Division. Washington, D.C. NTIS No. PB 84-185 552.

United States Environmental Protection Agency (EPA). [no publication date]. *Post-Construction Storm Water Management in New Development & Redevelopment: Alternative Turnarounds*. [http://cfpub.epa.gov/npdes/stormwater/menuofbmps/post\\_2.cfm](http://cfpub.epa.gov/npdes/stormwater/menuofbmps/post_2.cfm)

US Environmental Protection Agency (EPA) New England. (2009). “*Funding Stormwater Programs*” (Report No. EPA 901-F-09-004).

Walker, W. 1990. *P8 Urban Catchment Model*. IEP, Inc. for the Narragansett Bay Project NBP-90-50. Narragansett Bay Project: Providence, RI.

---

## **Appendix A**

Letter to Partners





STATE OF CONNECTICUT
DEPARTMENT OF ENVIRONMENTAL PROTECTION



May 12, 2010



The Connecticut Department of Environmental Protection (DEP) has initiated a project to explore opportunities to add low impact development (LID) concepts and planning into four stormwater general permits (SGPs)—construction, municipal separate storm sewer systems (MS4s), industrial, and commercial.

We will hold a workshop at our 79 Elm Street Offices in the Phoenix Auditorium on May 26, 2010 from 9:15 to 11:45 a.m. to begin the process. You are invited and an agenda for the meeting is attached.

Using American Reinvestment and Recovery Act funding, DEP entered into a contract with Fuss & O'Neill Consultants, who assisted us with the most recent update to the Stormwater Quality Manual.

A web page has been created on DEP's web site at:
http://www.ct.gov/dep/cwp/view.asp?a=2719&q=459488&depNav\_GID=1654

The website represents a node of communication for this project and will efficiently put project materials at your fingertips while avoiding unnecessary printouts, mailings, etc.

Why are we making this partner driven? We recognize that whatever policy is established will ultimately be implemented at the ground level by Connecticut's regulated sector and community organizations.

We very much look forward to working with you on this important project and look forward to seeing you May 26.

Sincerely,
Paul E. Stacey

Paul E. Stacey
Director
Bureau of Water Protection and Land Reuse
Planning and Standards Division



**AGENDA**  
**Stormwater General Permits and Incorporation of**  
**Low Impact Development Evaluation**  
May 26, 2010; 9:15 – 11:45 am  
CTDEP—79 Elm Street, Hartford; Phoenix Auditorium

1. Introductions
  - a. Opening Remarks
  - b. Introductions Around the Table
  - c. Future Meeting Dates and Locations
  - d. Web Page:  
([http://www.ct.gov/dep/cwp/view.asp?a=2719&q=459488&depNav\\_GID=1654](http://www.ct.gov/dep/cwp/view.asp?a=2719&q=459488&depNav_GID=1654))
2. Project Overview
  - a. Project Objectives
  - b. Points of Contact
  - c. Deliverables and Schedule
  - d. Partners
3. Overview of Low Impact Development (LID) and Stormwater General Permits (SGP)
  - a. What's LID?
  - b. Summary of Other States
  - c. Summary of Interviews with Partners
4. Identifying Alternatives and Criteria
5. Partner Involvement in Implementation
6. Next Steps

---

## Appendix B

Project Webpage



## DEPARTMENT OF ENVIRONMENTAL PROTECTION



[ABOUT US](#) [PROGRAMS AND SERVICES](#) [PUBLICATIONS](#) [FORMS](#) [CONTACT US](#) [HOME](#)

Search

### Stormwater General Permits and Incorporation of Low Impact Development Evaluation

WATER
<a href="#">» WATER RESOURCES</a>
<a href="#">» WATER QUALITY</a>
<a href="#">» WATER QUANTITY</a>
<a href="#">» WATERSHED MANAGEMENT</a>
<a href="#">» WETLANDS</a>
<a href="#">» REGULATING WATER</a>
<a href="#">» ENVIRONMENTAL PROTECTION BEGINS WITH YOU</a>
<a href="#">» WATER MAIN PAGE</a>
<a href="#">» DEP MAIN MENU</a>

The Connecticut Department of Environmental Protection (DEP) is in the process of evaluating the incorporation of Low Impact Development principles into our Stormwater General Permits. This process incorporates:

- Discussion of project including general purpose, goals and objectives
- Project partner work plan
- Partner workshop schedule, agendas, workshop summaries, and workshop materials
- Partner technical documents such as technical memoranda
- Project-related links
- Contact information

The DEP is responsible for protecting water quality under several regulatory programs including the US EPA's National Pollutant Discharge Elimination System or NPDES. The NPDES Storm Water Program, in place since 1990, regulates discharges from municipal separate storm sewer systems (MS4s), construction activities, industrial activities, and those designated by EPA due to water quality impacts. To further the goals and objectives of the NPDES legislation, the DEP intends to incorporate low impact development (LID) best management practices (BMPs) and pollution prevention practices in its regulatory policy. This means potentially building LID into current Stormwater Permits and Design Guidance Manuals including:

#### General Permits

- General Permit for the Discharge of Stormwater from Small Municipal Separate Storm Sewer Systems
- General Permit for the Discharge of Stormwater and Dewater Wastewaters from Construction Activities
- General Permit for the Discharge of Stormwater Associated with Industrial Activity
- General Permit for the Discharge of Stormwater Associated with Commercial Activity

#### Guidance Documents

- Connecticut Stormwater Quality Manual
- Connecticut Guidelines for Soil Erosion and Sediment Control

#### Four Tenets of LID

LID-style best management practices (BMPs), such as vegetative filter strips, pocket sand filters, and infiltration systems for example, have been available for the control of stormwater for several decades, however the LID approach to site design is a relatively recent development and represents a significant change in site planning and stormwater management philosophy. LID emphasizes working within the constraints of landscapes to prevent stormwater generation, while traditional stormwater management emphasizes shunting away stormwater and treating it to the extent practicable (e.g., 80% total



Department of  
Environmental Protection  
79 Elm Street  
Hartford, CT 06106-5127

Phone:  
(860) 424-3000  
Voice/TTY

[Directions](#)

**E-ALERTS**

Receive DEP news updates by e-mail.

>> [Subscribe now or update your e-Alerts](#)

>> **LOGIN**

suspended solids removal from the first inch runoff from impervious surfaces) at or near its point of discharge.

The ideal way to manage stormwater is by preventing runoff generation. LID is a group of stormwater management techniques that do just that by controlling stormwater at its source. This occurs through the application of four key principles:

- Minimizing site disturbance
- Working with site hydrology
- Minimizing and disconnecting impervious surface
- Applying small-scale controls at the source

#### Specific Goals and Objectives of this Process

Pursuant to this process DEP intends to:

- Establish LID and pollution prevention, performance goals, and criteria for management practices common to Stormwater General Permit implementation.
- Identify how the performance goals and criteria can be most effectively incorporated into the Stormwater General Permit(s) to meet permit limits and conditions; and
- Identify mechanisms for incorporating LID BMPs and pollution prevention practices into the Stormwater General Permit(s) for priority attention.

DEP also intends this process to explore several critical aspects of current and developing stormwater management practices to protect receiving waters and to provide clear regulatory guidance for the regulated community to effectively comply with permit requirements. This means providing the technical, planning and design tools necessary for effective site design, as well as a framework for broader compliance of the municipal regulatory community. These critical aspects include:

- Use of runoff volume as an indicator of environmental effect
- Relationship between volume control and pollutant control
- Appropriate permit limits for runoff volume relative to storm size
- Necessary guidance including performance criteria for LID and pollution prevention and end-of-pipe BMPs
- Role and benefit of stormwater utilities
- Building LID, stormwater utilities, and other management tools into permits and guidance
- Expanding the approach to other general permits such as the MS4 and Industrial Stormwater General Permits.

DEP also intends to explore approaches for incorporating LID into stormwater policies that are being used by other states.

Stakeholder Meetings: A series of five Stakeholder meetings are planned. All will be held at CT DEP, 79 Elm Street, Hartford, CT, in the Phoenix Auditorium, 5th Floor between 9:15 a.m. and 11:45 a.m.

#1 May 26, 2010: documents

- [Agenda](#)
- [CT Partner Interviews Summary Report](#)
- [Other States' Summary Report](#)
- [Summary of Workshop #1 Including Results of "Criteria" Cardstorming](#)
- [Workshop #1 Presentation: Introduction](#)
- [Workshop #1 Presentation: LID Overview](#)
- [Workshop #1 Presentation: Summary of Partner Interviews](#)

- [Workshop #1 Presentation: Project Overview](#)
- [Workshop #1 Presentation: Summary of US State General Permit Programs](#)

#2 July 1, 2010

- [Agenda](#)
- [Potential Low Impact Development Implementation Alternatives](#)
- [Evaluating the Role of Stormwater Utility Districts in the Implementation of Low Impact Development](#)
- [Carousel Workshop presentation](#)
- [Summary of Workshop #2](#)

#3 August 31, 2010

- [Agenda](#)
- [Technical Memorandum #1: Identification of Approaches for Including Low Impact Development and Pollution Prevention In General Permits](#)
- [Technical Memorandum #2: Evaluating the Role of Stormwater Utility Districts in the Implementation of Low Impact Development](#)
- [Summary #4: Rationale for Selection of Two Alternative Scenarios for Implementation](#)
- [Workshop #3 Presentation: Introductions, Meetings, and the Webpage](#)
- [Workshop #3 Presentation: Introduction to Cafe Workshop Dot voting](#)
- [Workshop #3 Summary of the Meeting](#)

#4 October 20, 2010

- [Agenda](#)
- [Technical Memorandum #3: Rationale for Selection of Alternative Scenarios for Implementation](#)
- [Summary #5 Low Impact Development Guidelines and Standards](#)
- [Workshop #4 Presentation: Partner Involvement in Implementation](#)
- [Workshop #4 Group Design Exercise](#)
- [Workshop #4 Summary of the Meeting](#)

#5 December 15, 2010

- [Agenda](#)

Background

- [Request for Proposals for Evaluation of Stormwater General Permits and Incorporation of Low Impact Development](#)
- [Responses to questions submitted on or before 12/18/09 on RFP for Evaluation of Stormwater General Permits and Incorporation of Low Impact Development](#)

For more information, contact MaryAnn Nusom Haverstock at (860) 424-3347 or email [MaryAnn.NusomHaverstock@ct.gov](mailto:MaryAnn.NusomHaverstock@ct.gov)

[Printable Version](#)

---

[Home](#) | [CT.gov Home](#) | [Send Feedback](#)

State of Connecticut [Disclaimer](#) and [Privacy Policy](#). Additional [DEP Disclaimer](#).  
Copyright © 2002, 2003, 2004, 2005, 2006, 2007, 2008, 2009 and 2010 State of Connecticut.

---



## **Appendix C**

---

### Summary of Workshop 1

## MEETING SUMMARY NOTES

### EVALUATION OF STORMWATER GENERAL PERMIT AND LID WORKSHOP 1—MAY 26, 2010; PHOENIX AUDITORIUM

DISTRIBUTION: Attendees and Other Project Partners

DATE: June 9, 2010

---

The following discussion summarizes the May 26, 2010 Workshop for the Evaluation of Stormwater General Permit and Low-Impact Development held at the Department of Environmental Protection Offices (79 Elm Street, Hartford, CT) in the Phoenix Auditorium.

A list of **workshop attendees** is provided at the end of this summary.

#### INTRODUCTIONS

##### *Opening Remarks*

MaryAnn Nusom Haverstock and Paul Stacey opened the meeting. Paul discussed the nature of the need for improved stormwater management and low-impact development (LID). He then turned the agenda over to Fuss & O'Neill.

##### *Introductions around the Table*

Jim Riordan of Fuss & O'Neill gave a PowerPoint Presentation, entitled "Introductions, Meetings, and the Web Page." A PDF copy is provided as **Attachment 1**.

Jim led the group in introductions. Each attendee gave their name, affiliation and a few words describing what they hoped for as a result of the project. At the conclusion, Jim asked that participants keep in mind the hoped-for result they had just described. A list of partners invited to participate in the project, which includes attendees and others invited, has been included as an attachment to this summary.

##### *Future Meeting Dates and Locations*

Jim recommended week timeframes for the next four meetings and meeting dates were selected as follows:

#### Project Meeting Dates

Workshop Title	Date to be Held
Partner Workshop 2	Thursday, July 1, 2010
Partner Workshop 3	Tuesday, August 31, 2010
Partner Workshop 4	Wednesday, October 20, 2010
Partner Workshop 5	Wednesday, December 15, 2010

##### Note:

*All meetings will be held from 9:15 a.m. – 11:45 a.m. in the Phoenix Auditorium at the Hartford, CT DEP Offices.*

##### *Web Page*

Jim introduced the project web page on DEP's website:

[http://www.ct.gov/dep/cwp/view.asp?a=2719&q=459488&depNav\\_GID=1654](http://www.ct.gov/dep/cwp/view.asp?a=2719&q=459488&depNav_GID=1654)

The web page will be used to provide project partners and other interested parties with general project information, schedules, and deliverables.

During the presentation, the following questions were raised:

- A question was asked about which general permits are being considered for revision under this project. Jim explained that four general permits are being reviewed—municipal separate storm sewer system (MS4), construction, industrial, and commercial. The MS4 permit and construction permit are the highest priority for examination.
- A follow-up question was asked regarding how these were chosen as priorities (i.e., was there a scientific reason behind this decision). Jim explained that the MS4 and construction general permits lend themselves to the use of LID because of the nature of the activities that they regulate including new development, operation and maintenance of management practices, and potential retrofit opportunities.

## **PROJECT OVERVIEW**

Jim gave a PowerPoint presentation entitled “Project Overview,” a copy of which is attached as a PDF (**Attachment 2**).

## **OVERVIEW OF LOW IMPACT DEVELOPMENT (LID) AND STORMWATER GENERAL PERMITS (SGP)**

### *What's LID?*

Jim gave a PowerPoint presentation entitled “Overview of LID,” a copy of which is attached as a PDF (**Attachment 3**).

### *Summary of Other States*

Phil Moreschi gave a PowerPoint presentation entitled “Summary of US State General Permitting Programs,” a copy of which is attached as a PDF (**Attachment 4**).

Several issues and questions arose during this presentation:

- The states of Virginia and Maryland should be included in the summary. Larry Coffman (subcontractor to Fuss & O'Neill on the project) may be able to assist in this regard as he is from Maryland.
- Questions about the specific incentives and the reasoning behind them were raised. Phil and Jim pointed out that two types of incentive are commonly used. One type having to do with water quality treatment “credit” for the use of LID on a specific project. The other type of incentive involves grants to municipalities and project proponents that wish to implement LID. Some regulatory agencies also fast-track permitting of projects that implement LID.

- Does Connecticut have statutory authority to require the implementation of LID within the general permits through the Federal Clean Water Act? It was pointed out by one participant that the Connecticut Attorney General's Office had researched a very similar issue previously and determined that authority exists at the state level under title 22A, chapter 40-30; therefore, the question of federal authority appears not critical for Connecticut.

*Summary of Interviews with Partners*

Jim gave a PowerPoint presentation entitled "Summary of Partner Interviews," a copy of which is attached as a PDF (**Attachment 5**).

## **IDENTIFYING ALTERNATIVES AND CRITERIA AND PARTNER INVOLVEMENT IN IMPLEMENTATION**

Jim facilitated a card storming and consensus-building session. The session was initiated with the following aims:

- Rational aim:                "*Identify criteria*" for selection of approaches to incorporate LID into state stormwater policy.
- Experiential aim:        "*Identify similarities*" in the approaches recommended by different partners in the group.

Card storming was initiated with the following question to the partners: "What are the features of good LID policy?" The card storming question and aim were posted on blue cards for the group of participants to consider during the session.

The card storming process worked as follows:

- Participants spent five minutes individually identifying five 3 to 5 word answers to the card storming question (What are the features of good LID policy?). Each answer was written on a 5" x 8" half-sheet of paper (card).
- Participants were asked to pair up with one other person to review their cards and select the clearest answer from the 10 reviewed. The card with that answer was then posted on an adhesive cloth (sticky wall) hung on the wall of the auditorium.
- The group was then asked to identify pairs of answers (e.g., if one pair of participants posted "flexibility" and another posted "flexible implementation" the group might identify these two postings as a pair). The **Photograph 1** (below) shows the sticky wall after the first round of postings and pairing exercise. During this exercise the group identified two pairs and two triplets. Triplets are not typical; however, in this particular case there were two natural groups of three.



**Photograph 1**—Sticky Wall after first round of postings and pairing. The card storming question and aims are posted on blue half-sheets of paper in the upper right and left corners of the Sticky Wall.

- Participant pairs were then asked to revisit their answers to the card storming question and identify two more ideas which had not been posted during the first round.
- Participants were then asked to review the posting to identify and group like answers to the card storming question. This part of the exercise is referred to as “clustering.” Once clusters were developed a shape card (i.e., orange half-sheet of paper with a shape (e.g., star, square, circle, etc.) drawn on it) was assigned to each group (see **Photograph 2**, below). Participants also began a process of assigning names to each cluster.

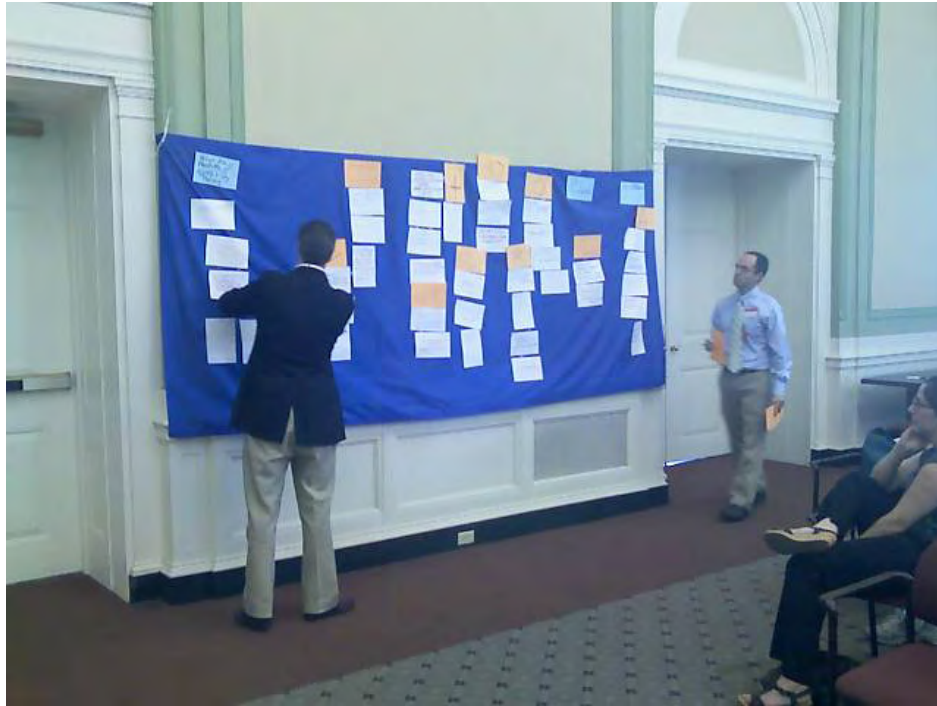

**Photograph 2**—Groups or “clusters” of card storming answers being assigned shapes.

- Participants were asked to review their card storming answers one final time and to identify any answers, which were not yet represented on the Sticky Wall.

At this point, the exercise was suspended due to time constraints. **Attachment 6** provides a summary of the sticky wall layout of the card storming exercise to this point. At the next workshop, participants will be asked to review the results of the card storming and clustering. Next steps will involve completion of assigning one- to two-word names in place of the shape cards and continued identification of similarities amongst the answers to the card storming question (what are the features of good LID policy?). Participants will also be asked to discuss their observations about the results of the exercise. We intend to use these results and observations to help to develop consensus during the next workshop about our continued approach to the project.

## **NEXT STEPS**

The next workshop will be held on **July 1 in the Phoenix Auditorium from 9:15 to 11:45 a.m.** This meeting will involve continued development of consensus on “what are good features of LID policy?” as well as alternatives for implementation. The meeting will also be used to explore the potential role of stormwater utility districts in implementation of LID policy and the stormwater general permits. In preparation for the meeting Fuss & O’Neill will continue to conduct partner interviews and will develop a summary of the potential role of stormwater utility districts based on literature and research.

## **ATTENDEES**

Attendees of the May 26 workshop are listed below in alphabetical order by affiliation.



<b>Attendee</b>	<b>Affiliation</b>
John Stelmokas	Advanced Drainage Systems
Rob Lemire	Advanced Drainage Systems
Brian Roach	Aquarion Water Co.
Eric Brown	CBIA
John Pagini	CCAPA
Melon Wedick	CCRPA
Virginia Mason	Council of Governments Central Naugatuck Valley
Faith Gavin Kuhn	Connecticut Associated Builders & Contractors
Jim Langlois	Connecticut Concrete
Matthew Hallssey	Connecticut Construction Industries
Jessica Morgan	Connecticut Department of Environmental Protection
Paul Stacey	Connecticut Department of Environmental Protection
Mary-Beth Hart	Connecticut Department of Environmental Protection OLISP
Chris Malik	Connecticut Department of Environmental Protection/NPS Program
MaryAnn Nusom Haverstock	Connecticut Department of Environmental Protection/NPS Program
Rob Hust	Connecticut Department of Environmental Protection- Water & Permitting
Chris Stone	Connecticut Department of Environmental Protection- Water Permitting
Nisha Patel	Connecticut Department of Environmental Protection- Water Permitting
Kimberly Lesay	Connecticut Department of Transportation
Roger Reynolds	Connecticut Fund for the Environment
Judy Rondeau	ECCD
Beth Edwards	EPA Region 1
Johanna Hunter	EPA Region 1

Steve Winnett	EPA Region 1
Anne Leiby	EPA Region 1 Boston
William Hurley	Fairfield Engineering
Erik Mas	Fuss & O'Neill
Jim Riordan	Fuss & O'Neill
Phil Moreschi	Fuss & O'Neill
Bill Ethier	Home Builders Association of Connecticut
Craig Scott	MDC
Becky Meyer	Milone & MacBroom Inc.
Greg Sharp	Murtha Cullina, LLP
Sean Hayden	Northwest Conservation District
Paul Balavender	O & G Industries, Inc.
John Hudak	Regional Water Authority
Kenneth Wieland	Rivers Alliance
Martha Mador	Rivers Alliance, Sierra
Leah Schmalz	Save The Sound/CPE
Nicole Davis	South Western Regional Planning Agency
Shelley Green	The Nature Conservancy
Denise Savageau	Town of Greenwich

## **Attachment 1**

---

Presentation to  
**Connecticut LID and  
SGP Partners**

Introductions, Meetings, and the  
Webpage

May 26, 2010



**FUSS & O'NEILL**  
*Disciplines to Deliver*

# Agenda

- Introductions
  - *Opening Remarks*
  - *Introductions Around the Table (10 minutes)*
  - *Future Meeting Dates and Locations (15 minutes)*
  - *Web Page:*  
([http://www.ct.gov/dep/cwp/view.asp?a=2719&q=459488&depNav\\_GID=1654](http://www.ct.gov/dep/cwp/view.asp?a=2719&q=459488&depNav_GID=1654))
- *Project Overview (20 minutes)*
  - *Project Objectives*
  - *Points of Contact*
  - *Deliverables and Schedule*
  - *Partners*
- Overview of Low Impact Development (LID) and Stormwater General Permits (SGP)
  - *What's LID? (10 minutes)*
  - *Summary of Other States (10 minutes)*
  - *Summary of Interviews with Partners (10 minutes)*
- Identifying Alternatives and Criteria
- Partner Involvement in Implementation
- Next Steps



# Introductions

- Name
- Affiliation
- One sentence (5 – 7 words) about the outcome you hope to see from this process.





# Meeting Schedule

## Partner Workshops and Topics of Discussion

Meeting	Topics	Approximate Date (week of)
Partner Workshop 1	<ul style="list-style-type: none"><li>• Project Initiation</li><li>• Partner work plan</li><li>• Criteria for alternatives selection</li><li>• Summary of information gathered from other states</li><li>• Summary of information gathered from the Partners</li><li>• Webpage</li></ul>	May 10, 2010
Partner Workshop 2	<ul style="list-style-type: none"><li>• Summary of the role stormwater utilities</li><li>• Partner consensus on three to five alternatives for further consideration under Task 4</li></ul>	June 28, 2010
Partner Workshop 3	<ul style="list-style-type: none"><li>• Summary of 3 – 5 alternative scenarios</li></ul>	August 23, 2010
Partner Workshop 4	<ul style="list-style-type: none"><li>• Write-up of draft LID standards</li></ul>	October 11, 2010
Partner Workshop 5	<ul style="list-style-type: none"><li>• Draft Final Report</li></ul>	December 13, 2010



# Webpage

[http://www.ct.gov/dep/cwp/view.asp?a=2719&q=459488&depNav\\_GID=1654](http://www.ct.gov/dep/cwp/view.asp?a=2719&q=459488&depNav_GID=1654)

The screenshot shows the website header for the Connecticut Department of Environmental Protection. The main title is "Stormwater General Permits and Incorporation of Low Impact Development Evaluation". The page includes a search bar, a navigation menu on the left with categories like "WATER", "WATER RESOURCES", "WATER QUALITY", "WATER QUANTITY", "WATERSHED MANAGEMENT", "WETLANDS", "REGULATING WATER", "ENVIRONMENTAL PROTECTION BEGINS WITH YOU", "WATER MAIN PAGE", and "DEP MAIN MENU". The main content area contains an introduction to the DEP's role in evaluating stormwater permits, a list of "General Permits" (including permits for small municipal systems, construction, industrial, and commercial activities), "Guidance Documents" (Stormwater Quality Manual and Soil Erosion/Sediment Control Guidelines), "Four Tenets of LID", and a description of LID-style best management practices (BMPs).

away stormwater and treating it to the extent practicable (e.g., 80% total suspended solids removal from the first inch runoff from impervious surfaces) at or near its point of discharge.

The ideal way to manage stormwater is by preventing runoff generation. LID is a group of stormwater management techniques that do just that by controlling stormwater at its source. This occurs through the application of four key principles:

- Minimizing site disturbance
- Working with site hydrology
- Minimizing and disconnecting impervious surface
- Applying small-scale controls at the source

#### Specific Goals and Objectives of this Process

Pursuant to this process DEP intends to:

- Establish LID and pollution prevention, performance goals, and criteria for management practices common to Stormwater General Permit implementation.
- Identify how the performance goals and criteria can be most effectively incorporated into the Stormwater General Permit(s) to meet permit limits and conditions; and
- Identify mechanisms for incorporating LID BMPs and pollution prevention practices into the Stormwater General Permit(s) for priority attention.

DEP also intends this process to explore several critical aspects of current and developing stormwater management practices to protect receiving waters and to provide clear regulatory guidance for the regulated community to effectively comply with permit requirements. This means providing the technical, planning and design tools necessary for effective site design, as well as a framework for broader compliance of the municipal regulatory community. These critical aspects include:

- Use of runoff volume as an indicator of environmental effect
- Relationship between volume control and pollutant control
- Appropriate permit limits for runoff volume relative to storm size
- Necessary guidance including performance criteria for LID and pollution prevention and end-of-pipe BMPs
- Role and benefit of stormwater utilities
- Building LID, stormwater utilities, and other management tools into permits and guidance
- Expanding the approach to other general permits such as the MS4 and Industrial Stormwater General Permits.

DEP also intends to explore approaches for incorporating LID into stormwater policies that are being used by other states.

#### Background

- [Request for Proposals for Evaluation of Stormwater General Permits and Incorporation of Low Impact Development](#)
- [Responses to questions submitted on or before 12/18/09 on RFP for Evaluation of Stormwater General Permits and Incorporation of Low Impact Development](#)

For more information, contact MaryAnn Nusom Haverstock at (860) 424-3347 or email [MaryAnn.NusomHaverstock@ct.gov](mailto:MaryAnn.NusomHaverstock@ct.gov)



## **Attachment 2**

---

Presentation to  
**Connecticut LID and  
SGP Partners**

Project Overview

May 26, 2010



**FUSS & O'NEILL**  
*Disciplines to Deliver*

# Presentation Overview

- Project Purpose
- Specific Project Objectives
- Potential Elements of a Policy Framework
- Meeting Schedule
- Anticipated Outcomes
- Points of Contact
  - *MaryAnn Nusom Haverstock (DEP)*
    - *Maryann.Nusomhaverstock@ct.gov*
    - *860-424-3347*
  - *Jim Riordan (Fuss & O'Neill)*
    - *jriordan@fando.com*
    - *401-861-3070 ext 4571*





# Project Purpose



- Build low-impact development (LID) into stormwater general permits (SGPs or GPs) and policy:
  - *Connecticut Stormwater Quality Manual*
  - *Connecticut Guidelines for Soil Erosion and Sediment Control*
- Partner-driven process, we want to begin to gather ideas at the start of the project





# Project Specific Objectives

- Establish LID approach for SGP
- Incorporate performance goals and criteria in SGPs
- Identify mechanisms to give LID priority attention

[http://www.ct.gov/dep/cwp/view.asp?a=2719&q=459488&depNav\\_GID=1654](http://www.ct.gov/dep/cwp/view.asp?a=2719&q=459488&depNav_GID=1654)



# Elements of a Policy Framework

- Runoff volume as an indicator
- Relationship between runoff volume and pollution control
- Permit limits relative to storm size
- Guidance with performance criteria
- Stormwater utilities



# Meeting Schedule

## Partner Workshops and Topics of Discussion

Meeting	Topics	Approximate Date (week of)
Partner Workshop 1	<ul style="list-style-type: none"><li>• Project Initiation</li><li>• Partner work plan</li><li>• Criteria for alternatives selection</li><li>• Summary of information gathered from other states</li><li>• Summary of information gathered from the Partners</li><li>• Webpage</li></ul>	May 10, 2010
Partner Workshop 2	<ul style="list-style-type: none"><li>• Summary of the role stormwater utilities</li><li>• Partner consensus on three to five alternatives for further consideration under Task 4</li></ul>	June 28, 2010
Partner Workshop 3	<ul style="list-style-type: none"><li>• Summary of 3 – 5 alternative scenarios</li></ul>	August 23, 2010
Partner Workshop 4	<ul style="list-style-type: none"><li>• Write-up of draft LID standards</li></ul>	October 11, 2010
Partner Workshop 5	<ul style="list-style-type: none"><li>• Draft Final Report</li></ul>	December 13, 2010



# Anticipated Outcomes

## Task, Deliverables, Schedule and Budget

Contract Tasks	Products	Completion Dates
Task 1—Project Initiation	<ul style="list-style-type: none"> <li>• Project Initiation Meeting agenda and minutes</li> <li>• List of work team members</li> <li>• Work team briefing</li> <li>• Work Team Meeting 1</li> <li>• Tabular List of potential partners</li> <li>• Draft interview form</li> <li>• Work Team Meeting Agenda and Minutes</li> <li>• Webpage launched.</li> <li>• Partner email group</li> </ul>	March 27, 2010
Task 2—Identify Approaches	<ul style="list-style-type: none"> <li>• Summary of information gathered from other states</li> <li>• Summary of information gathered from the Partners</li> </ul>	April 19, 2010
	<ul style="list-style-type: none"> <li>• Partner Workshop 1</li> <li>• Partner Workshop 1 Agenda and Minutes</li> <li>• Partner work plan</li> <li>• Criteria for alternatives selection</li> <li>• Technical Memorandum 1</li> </ul>	May 14, 2010
Task 3—Stormwater Utilities	<ul style="list-style-type: none"> <li>• Summary of the role stormwater utilities</li> </ul>	June 18, 2010
	<ul style="list-style-type: none"> <li>• Partner Workshop 2</li> <li>• Partner consensus on three to five alternatives for further consideration under Task 4</li> <li>• Partner Workshop 2 agenda and minutes</li> <li>• Technical Memorandum 2</li> </ul>	July 2, 2010





# Anticipated Outcomes

## Task, Deliverables, Schedule and Budget

Contract Tasks	Products	Completion Dates
Task 4—Two Alternatives	<ul style="list-style-type: none"> <li>• Summary of 3 – 5 alternative scenarios</li> </ul>	July 23, 2010
	<ul style="list-style-type: none"> <li>• Partner Workshop 3</li> <li>• Partner Workshop 3 agenda and minutes</li> <li>• Technical Memorandum 3</li> </ul>	August 27, 2010
	<ul style="list-style-type: none"> <li>• Write-up of draft LID standards</li> </ul>	September 17, 2010
Task 5—Connecticut's Guidance	<ul style="list-style-type: none"> <li>• Partner Workshop 4</li> <li>• Partner Workshop 4 Agenda and Minutes</li> </ul>	October 15, 2010
	<ul style="list-style-type: none"> <li>• Technical Memorandum 4</li> </ul>	November 12, 2010
	<ul style="list-style-type: none"> <li>• Draft Final Report</li> <li>• Partner Workshop 5</li> <li>• Partner Workshop 5 Agenda and Minutes</li> </ul>	December 17, 2011
Task 6—Final Report	<ul style="list-style-type: none"> <li>• Final Report</li> </ul>	January 31, 2011



# Partners

Potential Partner	Contacts
Connecticut Stormwater Program	Chris Stone Nisha Patel
Nonpoint Source Program	MaryAnn Nusom Haverstock Chris Malik Jessica Morgan
Aquifer Protection	Rob Hust
Office of Long Island Sound Program	Cheryl Chase Marybeth Hart
EPA	Steve Winnett Mark Tedesco Thelma Murphy
CT Business Industries Association	Eric Brown Chris Ecsedy
CT Construction Industries Association	Matt Halesy
Marine Trades Association	Ted Sailer Greg Sharp
CT Fund for the Environment	Leah Schmaltz Roger Reynolds
Farmington MLUE/LID grant recipient municipalities	Kim Barbieri (Torrington) Marty Connor (Colebrook) Hiram Peck (Simsbury) Mark Devoe (Plainville)
Additional Municipalities	Pat Sesto (Wilton)
Tolland, CT	Linda Farmer
Greenwich, CT	Denise Savigeau
Norwalk, CT	Mike Yeosock Alexis Cheritchetti
Fairfield, CT	Bill Hurley
South Central Regional Water Authority	John Hudak
MDC	Louise Guarnaccia Sally Nyron Brian Roach (Aquarion)
Connecticut Conference of Municipalities	Kachina Walsh-Weaver





# Partners

Potential Partner	Contacts
Farmington MLUE/LID grant recipient municipalities	Kim Barbieri (Torrington) Marty Connor (Colebrook) Hiram Peck (Simsbury) Mark Devoe (Plainville)
Wilton, CT	Pat Sesto
Tolland, CT	Linda Farmer
Greenwich, CT	Denise Savigeau
Norwalk, CT	Mike Yeosock Alexis Cheritchetti
Fairfield, CT	Bill Hurley
Connecticut Conference of Municipalities	Kachina Walsh-Weaver
South Central Regional Water Authority	John Hudak
MDC	Louise Guarnaccia Sally Nyron Brian Roach (Aquarion)
CT Fund for the Environment	Leah Schmaltz Roger Reynolds
Rivers Alliance	Margret Miner
The Nature Conservancy	Sally Harold Shelly Green
Green Valley Institute	Susan Westa
CT Chapter of American Planners Assn. CCAPA	John Pagini



# Partners

Potential Partner	Contacts
COG Central Naugatuck Valley	Virginia Mason
Litchfield Hills Council of Elected Officials	Rick Lynn
Housatonic Valley CEO	Jon Chew
Southeastern Connecticut Council of Government	James Butler
CT Regional Council of Governments	Lia Huang
SW CT Regional Planning Agency	Floyd Lapp Nicole Davis



## **Attachment 3**

---

Presentation to  
**Connecticut LID and  
SGP Partners**

LID Overview

May 26, 2010



**FUSS & O'NEILL**  
*Disciplines to Deliver*

# *The Problem: Conventional Site Design*

*Collect*  
*Concentrate*  
*Convey*  
*Centralized*  
*Control*



*Good Drainage Paradigm*



# Conventional Development

Centralized  
Pipe and Pond  
Control

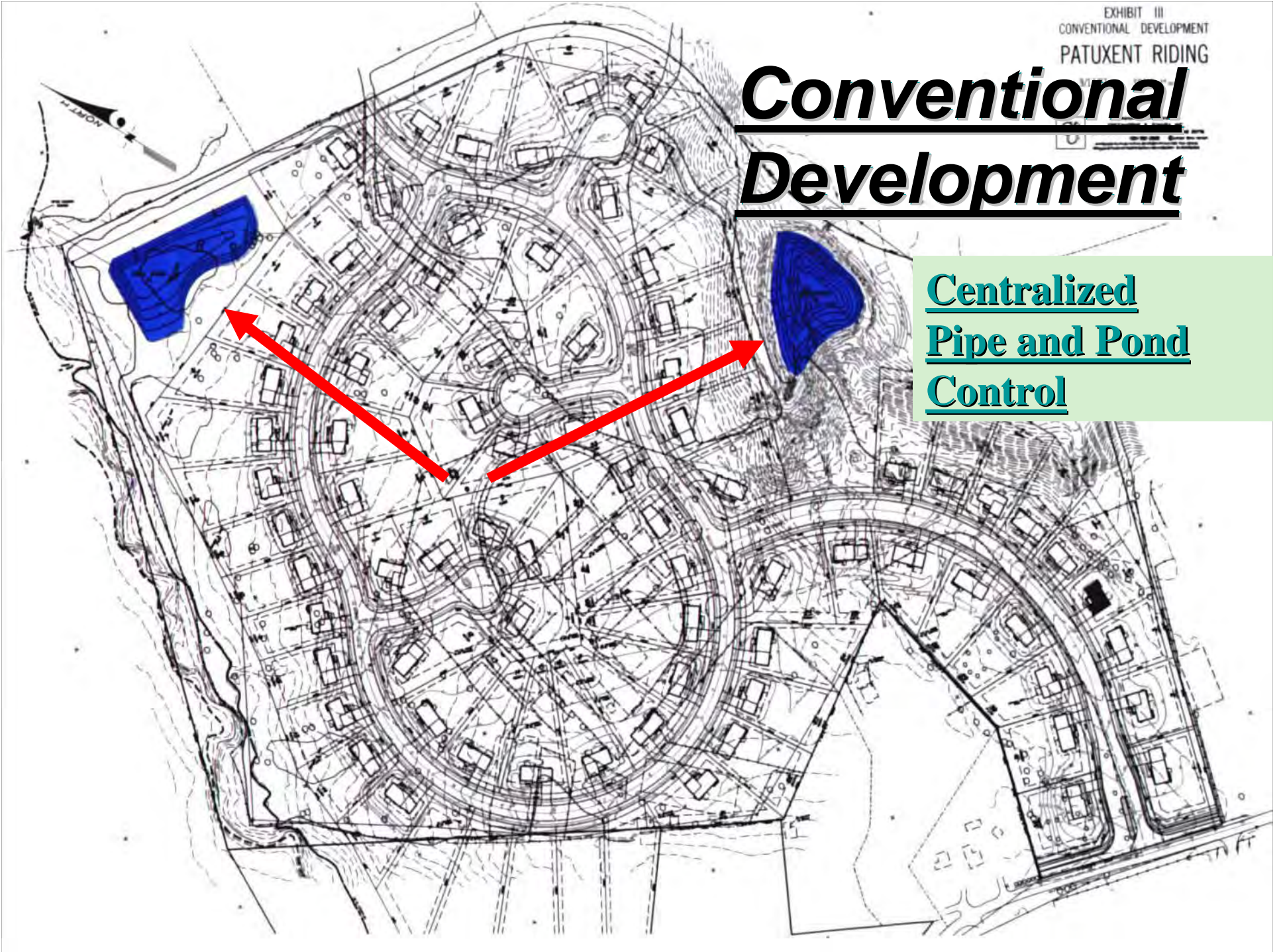



# Natural Conditions



Courtesy May, U of W



# Developed Conditions

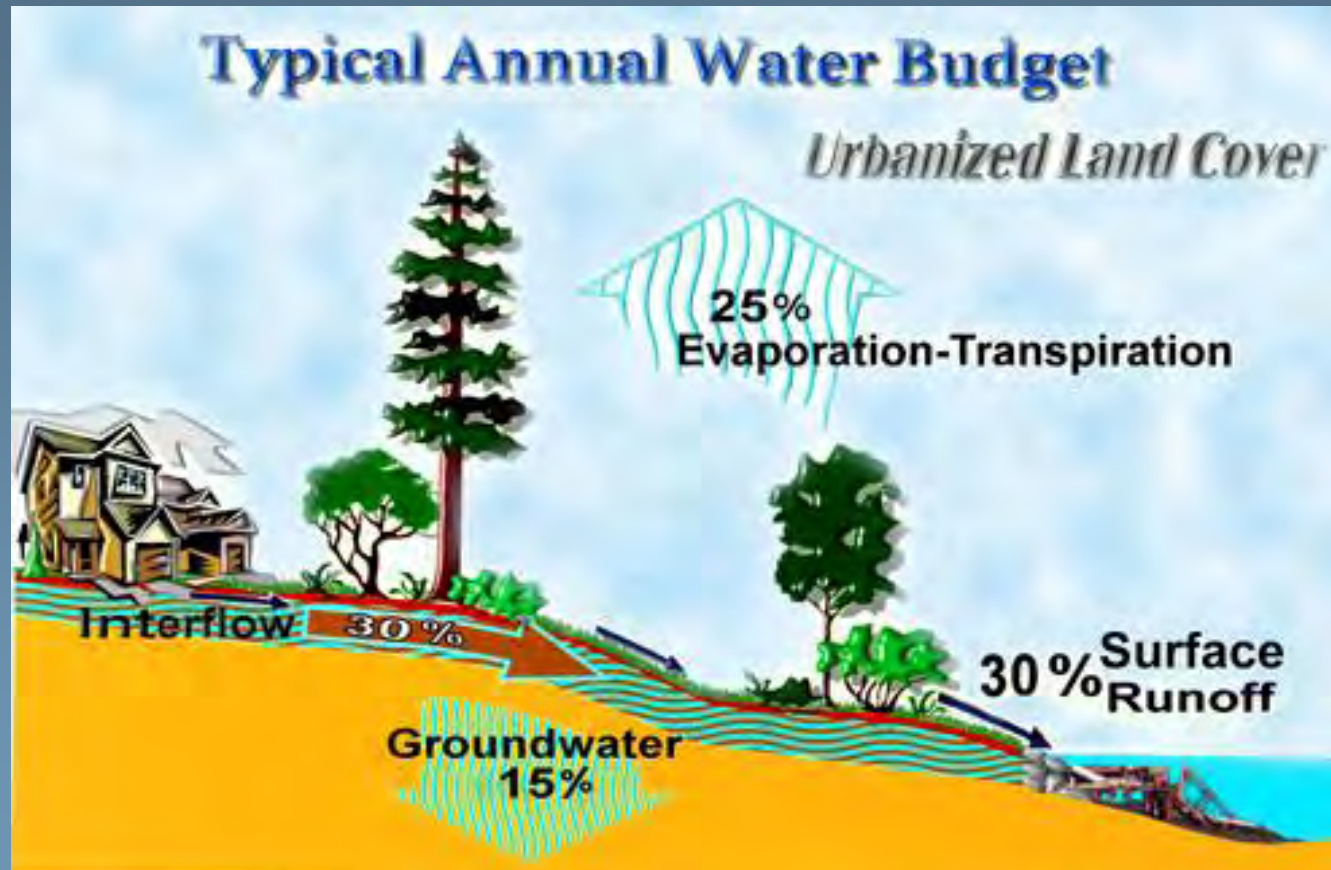

# Low Impact Development Overview

- **New Philosophy**
  - *Maintaining Functional Relationships Between Terrestrial and Aquatic Ecosystems*
  - *Keep Water Where it Falls*
- **New Principles**
  - *Decentralized / Source Control*
  - *Distributed / Multi-functional / Multi-beneficial*
- **Old Approaches Used at a Small Scale**
  - *Retain / Detain / Filter / Infiltrate / Treat / Prevent / Use*
- **New Development Process**
  - *Conserve / Minimize / Maintain Timing / Integrate Control Practices / Prevention*



# Defining LID Technology

## Major Components

1. Conservation (Watershed and Site Level )
2. Minimization (Site Level)
3. Strategic Timing (Watershed and Site Level)
4. Integrated Management Practices (Site Level)  
*Retain / Detain / Filter / Recharge / Use*
5. Pollution Prevention  
*Traditional Approaches*





# 1. Conservation Plans / Regulations

- **Local Watershed and Conservation Plans**

- *Forest (Contiguous and Interior Habitat)*
- *Streams*
- *Wetlands*
- *Habitats*
- *Step Slopes*
- *Buffers*
- *Critical Areas*
- *Parks*
- *Scenic Areas*
- *Trails*
- *Shorelines*
- *Difficult Soils*
- *Ag Lands*
- *Minerals*



## 2. Minimize Impacts

- Minimize clearing
- Minimize grading
- Save A and B soils
- Limit lot disturbance
- \* Soil Amendments
- Alternative Surfaces
- Reforestation
- Disconnect
- Reduce pipes, curb and gutters
- Reduce impervious surfaces





### 3. Maintain Time of Concentration

- **Open Drainage**
- **Use green space**
- **Flatten slopes**
- **Disperse drainage**
- **Lengthen flow paths**
- **Vegetative swales**
- **Maintain natural flow paths**
- **Increase distance from streams**
- **Maximize sheet flow**



## 4. Storage, Detention & Filtration LID IMPs

- Uniform Distribution at the Source
  - *Open drainage swales*
  - *Rain Gardens / Bioretention*
  - *Smaller pipes and culverts*
  - *Small inlets*
  - *Depression storage*
  - *Infiltration*
  - *Rooftop storage*
  - *Pipe storage*
  - *Street storage*
  - *Rain Water Use*
  - *Soil Management*



## 5. Pollution Prevention

- BMP Maintenance
- Pollutants proper use, handling and disposal
  - *Individuals*
    - *Lawn / car / hazardous wastes / reporting / recycling*
  - *Industry*
    - *Good house keeping / proper disposal / reuse / spills*
  - *Business*
    - *Alternative products / Product liability*



# How Does LID Maintain or Restore The Hydrologic Regime?

- Creative ways to:
  - Maintain / Restore Storage Volume
    - interception, depression, channel
  - Maintain / Restore Infiltration Volume
  - Maintain / Restore Evaporation Volume
  - Maintain / Restore Runoff Volume
  - Maintain Flow Paths
  - Water Use
- Engineer a site to mimic the natural water cycle functions / relationships





# Volume and Hydrology as the Organizing Principles

- **Unique Watershed Design**
  - *Match Initial Abstraction Volume*
  - *Mimic Water Balance*
- **Uniform Distribution of Small-Scale Controls**
- **Cumulative Impacts of Multiple Systems**
  - *filter / detain / retain / use / recharge / evaporate*
- **Decentralized / Disconnection**
- **Multifunctional Multipurpose Landscaping & Architecture**
- **Prevention**



**1992 Somerset MD**  
**Treatment Train Approach**

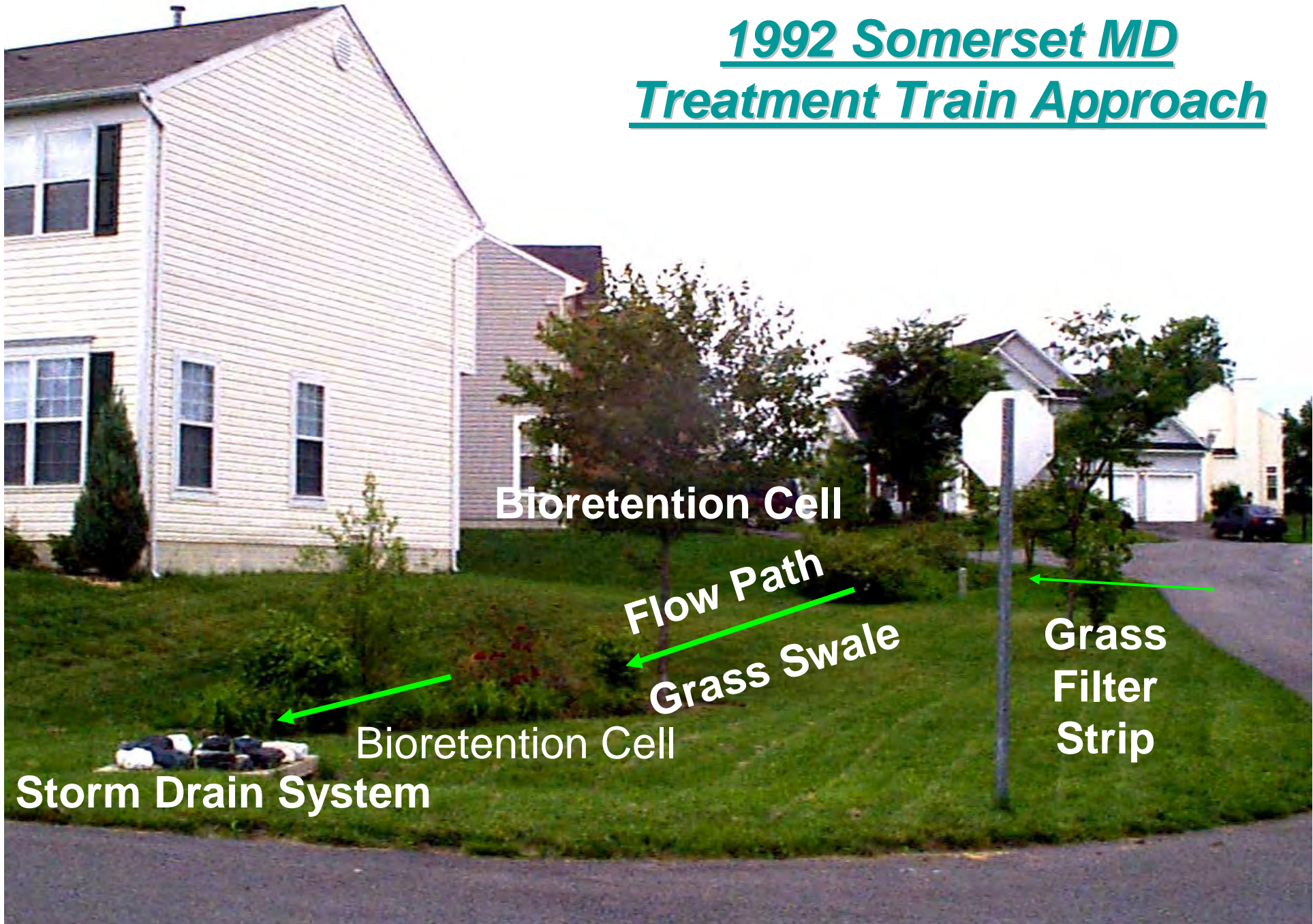

**Bioretention Cell**

**Flow Path**

**Grass Swale**

**Grass  
Filter  
Strip**

**Bioretention Cell**

**Storm Drain System**





**MAY 29 2001**





Rain Garden installed into a planter box on a 100% impervious cover residential mid-rise project in Old Town Alexandria. Roof-drains are within building façade.





*Structured Parking*

**Runoff Storage Filtration**





MAY 18 2001

**Buckman Heights courtyard with infiltration garden**



# Vegetated Conveyance



## **Attachment 4**

---



Presentation to  
**Connecticut LID and  
SGP Partners**

Summary of Partner Interviews

May 26, 2010



**FUSS & O'NEILL**  
*Disciplines to Deliver*

# Presentation Overview

- Background
- Informing and Engaging Partners
- Telephone Interviews
- Findings



# Background and Purpose

- Partner-driven process, we want to begin to gather ideas at the start of the project
- We will continue to gather your ideas throughout the project using workshops and reviews of project materials

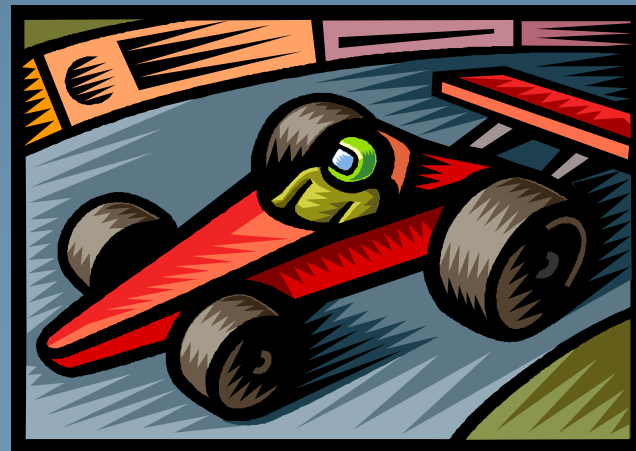

# Informing and Engaging Partners

- Letter from Paul Stacey
- Phone interviews
- Webpage
  - Agendas and summaries
  - Workshop presentations
  - Project reports and deliverables



[http://www.ct.gov/dep/cwp/view.asp?a=2719&q=459488&depNav\\_GID=1654](http://www.ct.gov/dep/cwp/view.asp?a=2719&q=459488&depNav_GID=1654)



# Telephone Interviews

- Interviewed 17 partners through May 19
- Fuss & O'Neill placed calls
- Interviews were loosely based on an interview questionnaire



# Findings—Are You Familiar...?

- 13 of 17 said “yes.”
- 3 said “a little” or “somewhat.”
- 1 answered “no.”

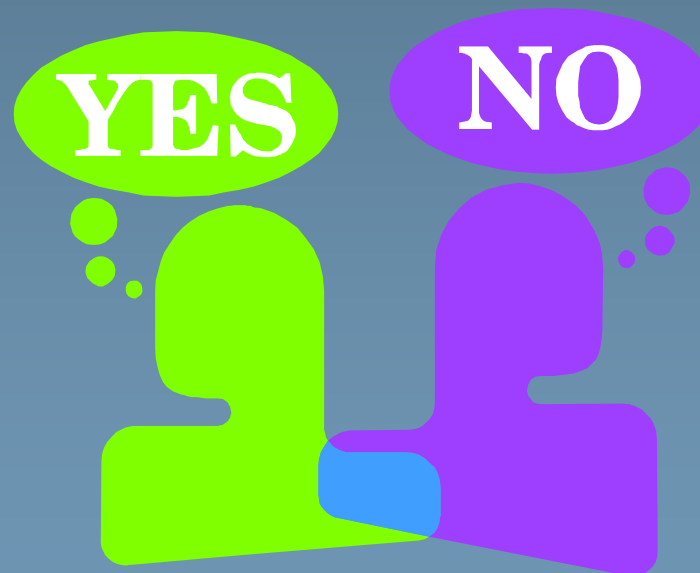



# Findings—Experience with LID

**Table 1**  
**Interviewee Reports of Experience with LID**

Type of LID Experience	Number of Responses	Percentage of Responses
At Least Some Experience	13	76%
Policy or Advocacy Only	4	24%
Project Experience Only	2	12%
Both Project and Policy	5	29%



# Findings—How should LID be Incorporated?

**Table 2**  
**Interviewee's Preference for Type of LID Standard**

Type of LID Standard	Number of Responses <sup>1</sup>	Percentage of Responses
Guidance	5	29%
No Regulation	5	29%
Incentive-Based Approach	2	12%
Regulation	6	35%
Performance Standard	4	24%
Not sure or no response	3	17%

Note:

1 Total number of responses do not sum to 17 as several respondents suggested use of a combination of approaches.



# Findings—BMP of Choice?

**Table 3**  
**Interviewee's Response to the Question**  
**"Should LID be the BMP of Choice?"**

<b>Should LID be the BMP of Choice?</b>	<b>Number of Responses</b>	<b>Percentage of Responses</b>
Yes no Qualification	4	24%
Yes with Qualification	8	48%
No Response	1	6%
Other Approach Suggested	3	17%
No	0	0%



# Findings—Demonstration of LID?

**Table 4**  
**Interviewee's Response to the Question**  
**"How Should LID be Demonstrated?"**

<b>How Should LID be Demonstrated?</b>	<b>Number of Responses</b>	<b>Percentage of Responses</b>
Runoff Volume	4	24%
Graduated Permit Limits	1	6%
Pollutant Levels Based on Runoff Volume	1	6%
Performance Criteria	3	17%
No Response or Not Sure	5	29%
Suggested "Flexibility" in Response	2	12%
Suggested "Simplicity" in Response	3	17%
Other Approach Suggested	3	17%



# Findings—Utility Districts?

**Table 5**  
**Interviewee's Response to the Question**  
**“Should we use Stormwater Utility Districts as a Regulatory Device?”**

<b>Should we use Utility Districts as a Regulatory Device?</b>	<b>Number of Responses</b>	<b>Percentage of Responses</b>
Yes	4	24%
Maybe, Not Sure, etc.	6	6%
No	7	6%
Politically Unlikely	6	17%
Unnecessary Government	5	29%





# Findings—What Role would you ?

**Table 6**  
**Interviewee's Response to the Question**  
**“What Role would you like to Play?”**

<b>What Role would you like to Play?</b>	<b>Number of Affirmative Responses</b>	<b>Percent of Affirmative Responses</b>
Develop and/or Review Policy and Standards	15	88%
Engage a Constituency	12	71%
Education and Training of Others	14	82%
Qualified Local Program and Utility Districts	7	40%
Participation as a Partner	15	88%





## **Attachment 5**

---

Presentation to  
**Connecticut LID and  
SGP Partners**

Summary of US State General  
Permitting Programs

May 26, 2010



**FUSS & O'NEILL**  
*Disciplines to Deliver*

# Presentation Overview

- Background and Purpose
- Methods of Collection
- State Information Collected and Interviews with Program Managers
- Key Findings



# Background and Purpose

- Reviewed 20 State Programs
- Ideas that may:
  - *Inform Connecticut's approach*
  - *Create a starting point for discussion*
  - *Germinate ideas for Connecticut*



# Methods of Data Collection

- Two Basic Methods:
  - *Web searches and webpage mining*
  - *Interviews with stormwater managers*



# State Information & Interviews

## We Collected Information from the Following States:

- Alaska
- Arizona
- California
- Florida
- Idaho
- Maine
- Massachusetts
- Minnesota
- Nevada
- New Mexico
- New Hampshire
- New York
- Oklahoma
- Oregon
- Pennsylvania
- Rhode Island
- Vermont
- Washington
- West Virginia
- Wisconsin





# State Information & Interviews

We Conducted Interviews with the 13 Highlighted States:

- Alaska
- Arizona
- California
- Florida
- Idaho
- Maine
- Massachusetts
- Minnesota
- Nevada
- New Mexico
- New Hampshire
- New York
- Oklahoma
- Oregon
- Pennsylvania
- Rhode Island
- Vermont
- Washington
- West Virginia
- Wisconsin



# Findings—Summary Format

- Narrative Discussion Including:
  - *General (overview)*
  - *General permits—focus on four permit types (**construction**, **MS4**, industrial, and commercial)*
  - *Performance standards*
  - *References*

Specific Standards Found in Alaska General Permits

Key Items	Standards
Runoff volume as an environmental indicator	Not Found
Volume control in relation to pollutant control	Not Found
Permit limits related to storm size and runoff volume	Not Found
Performance criteria	Not Found
LID	Not Found
Pollution prevention	Not Found
End of pipe	Not Found



# Findings--General

## The Following States have LID Guidance Documents:

- Alaska
- California
- Idaho
- Maine
- Massachusetts
- Minnesota
- New Hampshire
- New York
- Pennsylvania
- Rhode Island
- Vermont
- Washington
- West Virginia



# Findings—General

## LID in GPs or Regulation

- California—encouraged in GP
- Maine—encouraged in regulation
- Massachusetts—SW policy
- Minnesota—pollution prevention
- New York—GP cites manual
- Rhode Island—GP cites LID
- Vermont—towns required; LID encouraged in IPs
- Washington—Added to GPs
- West Virginia—1” standard in GP



# Findings—General

## Where is LID Encouraged, but not Required?

- Alaska—Guidance, but not required
- Arizona—Some locals use incentives
- California—Encouraged in GP; Regions may require
- Idaho—Guidance, but not required
- Maine—Regulations strongly encourage
- Minnesota—Extensive guidance
- New Hampshire—Guidance, but not required
- New York—Guidance, but not required
- Oklahoma—LID promoted by locals
- Pennsylvania—Guidance, but not required
- Vermont—Guidance, but not required
- West Virginia—Encourage in CGP, but required of MS4s



# Findings—Performance Stnds

What Types of Performance Standard are used?

Type of Standard	Examples
Runoff Volume	<ul style="list-style-type: none"><li>• WQV (1", 0.5", 25%, etc.); require or encourage LID</li></ul>
Pollution Reduction (linked to volume)	<ul style="list-style-type: none"><li>• 80 or 90% TSS</li><li>• Turbidity</li><li>• Nutrients</li><li>• Sensitive sites</li></ul>
Performance standard	<ul style="list-style-type: none"><li>• Area set-aside for LID</li><li>• MEP and narrative</li><li>• Imperviousness reduction</li></ul>





# Findings—LID Primacy

What Types of Standards are used to Establish Primacy?

Type of Standard	Examples
Runoff Volume	<ul style="list-style-type: none"><li>• Percentage or Fraction of WQV</li></ul>
Performance standard	<ul style="list-style-type: none"><li>• Area set-aside for LID</li><li>• MEP and narrative</li><li>• Imperviousness reduction requirements</li></ul>



## **Attachment 6**

---

**Card Storming Question:**  
What are the features of good LID policy?

**Objective Card Storming Aim:**  
Identify criteria [for determining alternatives]

**Experiential Card Storming Aim:**  
Identify similarities [in participants ideas of good LID policy]

 **Economic Viability**

- Enough incentive to achieve success
- Market/demand sensitivity
- Cost effective options, not regulations
- Recognize market demands for different development types (LID may not be for all)
- Funding for implementation
- Effectiveness can be verified and maintenance is not cost prohibitive



- Clarity
- Uniform statewide (standardized)
- Make any guidance and/or standards simple. Make process certain.
- Should be expected and standard operating procedure not as the exception
- LID policy at the local level to adopt, enforce, implement

 **Legal Administrable**

- Easy to administer
- Aligning municipal zoning subdivision regulations (with LID)
- Encouragement TPZ, cons[ervation] subdivision regulations
- Available support structure mechanism for contractors/homeowners implementing LID
- Compatible with other regulations and goals that are necessary i.e., ADA, mosquito control, public safety, public health
- Legal

 **Flexibility**

- Flexible
  - Consider site constraints
  - Consider project type
- Flexible
- Room for innovation
- Performance based (about objective, not technique)
- Bottom-up site specific approach, not top down.

 **Conservation**

- Resource based design (e.g., soils)
- Allow soil microorganisms to work
- Shift focus from engineering to conservation



- Practical to implement and maintain
- Not burdensome to individuals, easy to comply with
- Maintenance required

 **Education**

- Education component
- Knowledgeable design engineers training, train
- Use good science and knowledgeable people to make decisions
- Public acceptance—meaning willingness to act a local/residential scale
- Greatest behavior change Promote policies (regulatory and/or voluntary) that result in greatest behavior change

 **Environmental Benefit**

- Manages soil erosion
- Reduction of impervious materials
- Remediates already built areas
- Promotes GW recharge
- Water quality & water quantity (groundwater (in-stream recharge) flow techniques)
- Reduces runoff
- Minimize impervious cover
- Fix impairment

 **Regulatory**

- Oversight from local and state agencies
- Enforceability
- Treats stormwater runoff with the same strict criteria that are required of on-site septic systems

---

## **Appendix D**

### Summary of Workshop 2

**MEETING SUMMARY NOTES**  
**EVALUATION OF STORMWATER GENERAL PERMIT AND LID**  
**(Contract # PS2010-10172)**  
**WORKSHOP 2—JULY 1, 2010; PHOENIX AUDITORIUM**

DISTRIBUTION: Attendees and Other Project Partners  
DATE: July 12, 2010

---

The following discussion summarizes the July 1, 2010 Workshop for the Evaluation of Stormwater General Permit and Low-Impact Development held at the Department of Environmental Protection Offices (79 Elm Street, Hartford, CT) in the Phoenix Auditorium.

A list of **workshop attendees** is provided at the end of this summary.

## INTRODUCTIONS

### *Opening Remarks*

MaryAnn Nusom Haverstock opened the meeting. During her opening, she pointed out that the issue of legal authority to require low impact development (LID) as part of the stormwater general permits had been vetted between the Environmental Protection Agency—New England (EPA) and Connecticut Department of Environmental Protection (DEP) and such authority is clearly present in existing state law. MaryAnn asked attendees to introduce themselves around the table. She then turned the agenda over to Fuss & O'Neill.

### *Introductions around the Table*

Jim Riordan of Fuss & O'Neill gave a PowerPoint Presentation, entitled "Introductions, Meetings, and the Web Page." The presentation is available on:

[http://www.ct.gov/dep/cwp/view.asp?a=2719&q=459488&depNav\\_GID=1654](http://www.ct.gov/dep/cwp/view.asp?a=2719&q=459488&depNav_GID=1654)

### *Future Meeting Dates and Locations*

Jim reconfirmed the next three meetings and meeting dates, which were set during Workshop 1 (May 26). The dates are as follows:

## Project Meeting Dates

<b>Workshop Title</b>	<b>Date to be Held</b>
Partner Workshop 3	Tuesday, August 31, 2010
Partner Workshop 4	Wednesday, October 20, 2010
Partner Workshop 5	Wednesday, December 15, 2010

### Note:

*All meetings will be held from 9:15 a.m. – 11:45 a.m. in the Phoenix Auditorium at the Hartford, CT DEP Offices.*

### *Web Page*

Jim reintroduced the project web page on DEP's website:

[http://www.ct.gov/dep/cwp/view.asp?a=2719&q=459488&depNav\\_GID=1654](http://www.ct.gov/dep/cwp/view.asp?a=2719&q=459488&depNav_GID=1654)

The web page will be used to provide project partners and other interested parties with general project information, schedules, and deliverables.

## IDENTIFYING ALTERNATIVES AND CRITERIA AND PARTNER INVOLVEMENT IN IMPLEMENTATION (continued)

At the May 26 workshop, a card storming and consensus-building session was facilitated. The session was partially completed. Therefore, the July 1 workshop involved a continuation of the session. Jim led meeting attendees in this continuation (see **Photograph 1**). Results included recombination of several of the card storming clusters formed during the May 26 workshop and naming of the resulting clusters.



**Photograph 1**—Results during the July 1 workshop included rearrangement of clustered cards as well as naming of the clusters.

Some of the specific changes included:

- Combining “Practical” and “Flexibility” into “Practicability-Flexibility.”
- Moving “Conservation” into “Environmental Benefit.”
- Placing “Legal Administrable” into the parking lot.<sup>1</sup>
- Moving “Regulation” into “Administrable.”
- Changing “Economic Viability” to “Economic Market Viability.”
- Naming the cards under the “+” symbol “Clear and Understandable.”

A discussion point was raised about whether the flow management capacity of LID BMPs would be quantifiable and, therefore, could be used to achieve peak flow attenuation requirements. A card was added under the topic of “administrable”:

- Quantifiable-measurable for other permit requirements that might duplicate.

During this session, a point was raised that some of cards and clusters were more closely related to implementation than the actual workshop question of “what are features of good LID policy?” Jim offered to the group that one solution would be to change the workshop

---

<sup>1</sup> The “parking lot” refers to holding further discussion for now in order to continue forward on other issues in the workshop. Some discussion occurred over the issue of whether or not DEP has legal authority to require LID. DEP has established this authority and intends to document it. DEP intends to document their legal authority. The topic of “administrable” was retained in place of “Legal Administrable.”



question to include implementation. Ultimately, the group decided to leave the workshop question, cards, and clusters without change.

Results of the card storming exercise are shown in **Photograph 2** and type written in **Attachment 2**. Six named clustered resulted:

- Economic Market Viability
- Clear and Understandable
- Practicable Flexibility
- Administrable
- Education
- Environmental Benefit



**Photograph 2**—Complete results of card storming conducted during May 26 and July 1 workshops.

## **STORMWATER UTILITY DISTRICTS**

Jim gave a PowerPoint presentation regarding the potential role of stormwater utility districts in the implementation of LID. The presentation is available on:

[http://www.ct.gov/dep/cwp/view.asp?a=2719&q=459488&depNav\\_GID=1654](http://www.ct.gov/dep/cwp/view.asp?a=2719&q=459488&depNav_GID=1654)

## **CAROUSEL WORKSHOP**

Jim introduced the carousel workshop with a PowerPoint presentation, which included a brief discussion of five implementation alternatives. The presentation is available on:

[http://www.ct.gov/dep/cwp/view.asp?a=2719&q=459488&depNav\\_GID=1654](http://www.ct.gov/dep/cwp/view.asp?a=2719&q=459488&depNav_GID=1654)

This included the following:

- 12 minutes each participant lists 5 pros & 5 cons for each of the 5 alternatives and 3 alternatives that haven't been considered.
- Split up into 6 groups and pick a "reporter."
- 5 minutes at each station:
  - List 5 strengths, 5 weaknesses, 5 benefits, and 5 dangers of each of the 5 alternatives
  - At Station 6, list alternatives that haven't been recommended
- Repeat process at other 5 alternatives. You can star or emphasize items you see as critical.
- Reporter presents findings (2 minutes for each reporter) at your group's last alternative.



**Photographs 3 - 6**—Carousel workshop in process.

The results of the carousel workshop are shown in **Photograph 2** and type written in **Attachment 2**.





# 2 NON REGULATORY

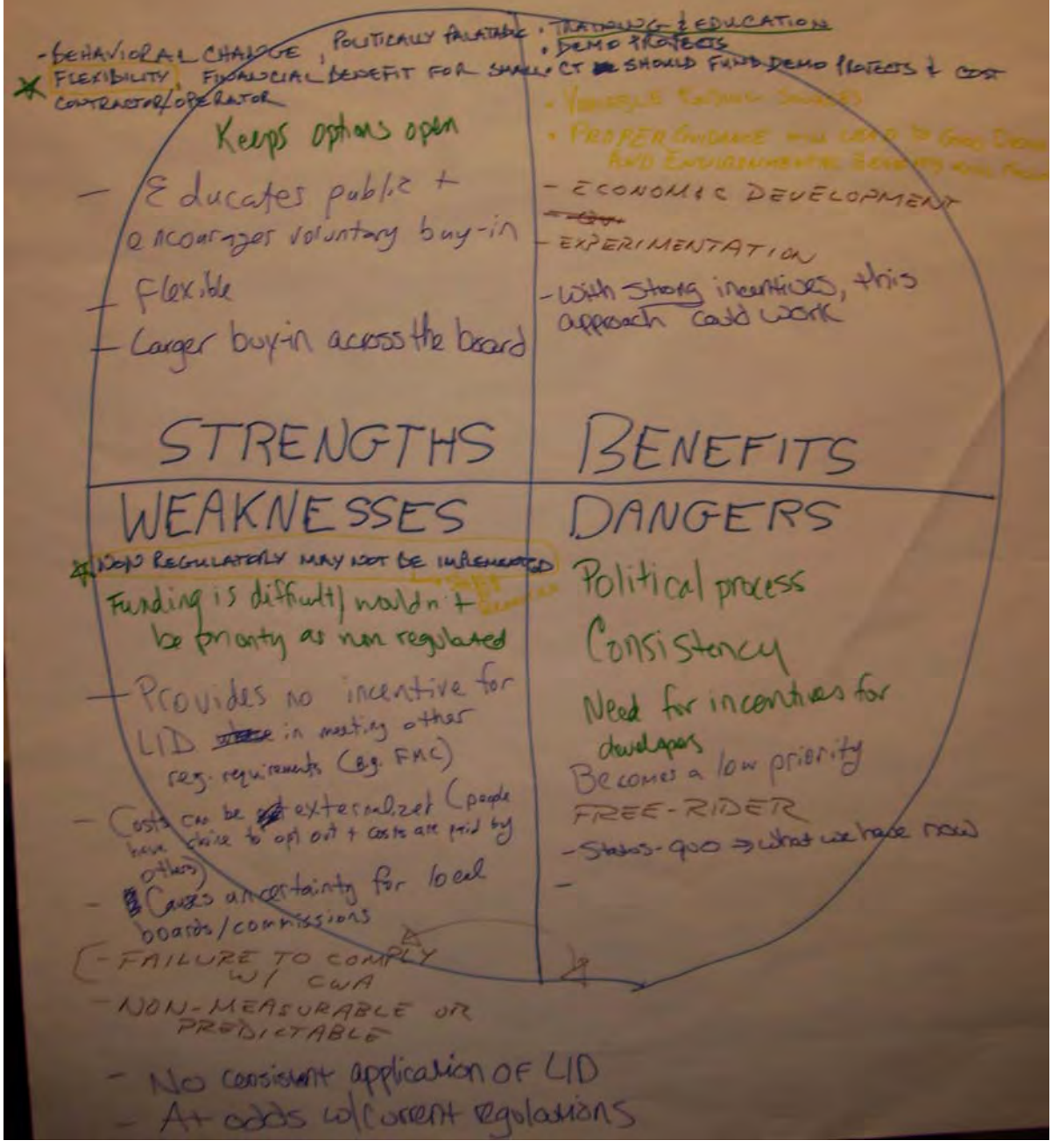

# 3) PERFORMANCE STANDARDS

? 26: IMPACTANCE TO NEED FOR MEASUREMENT QUANTIFIABLE MEASURE  
 NOT NEEDED IF ALL MAKE L&O WORK!

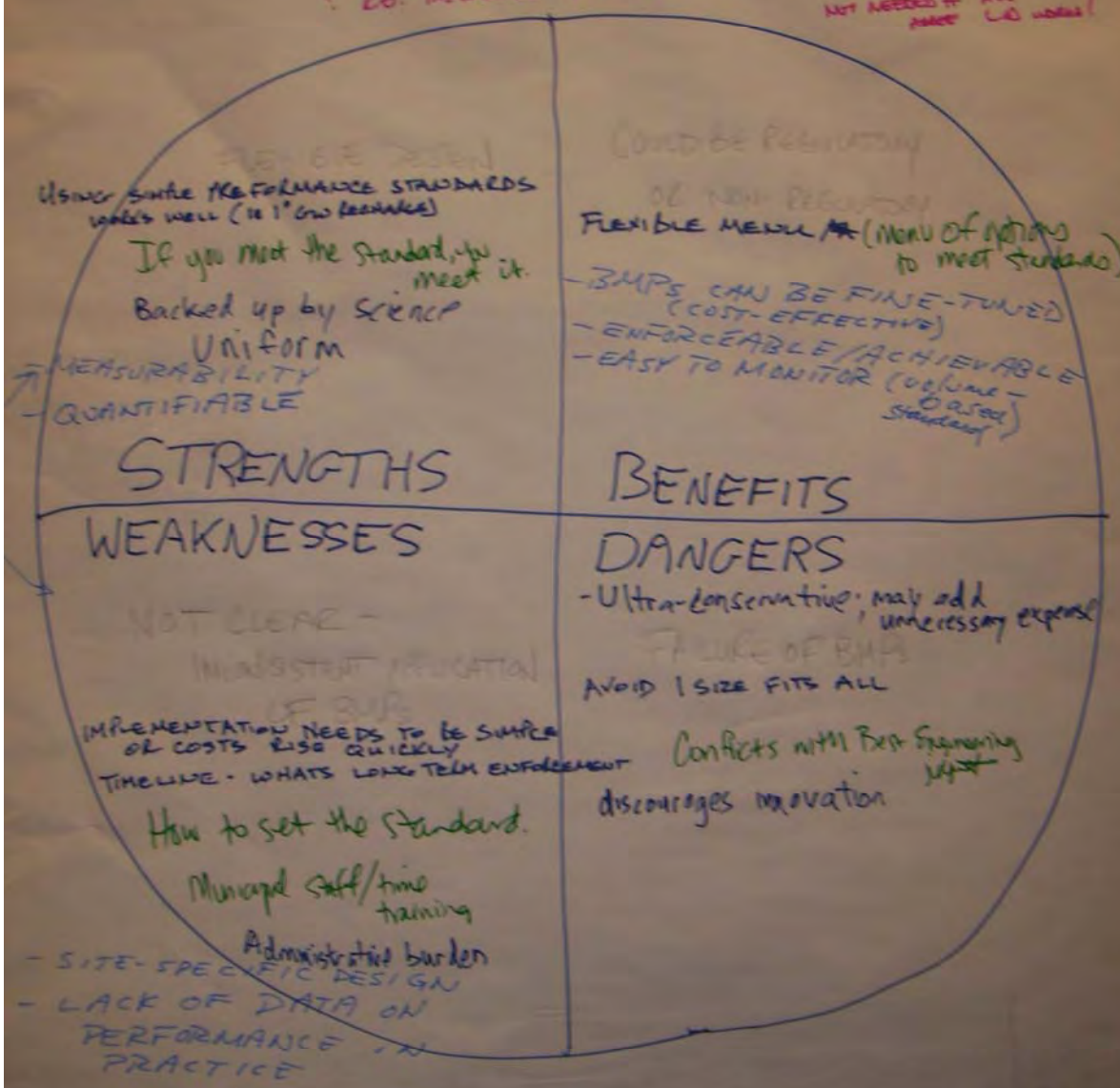



4

# Pollution Reduction

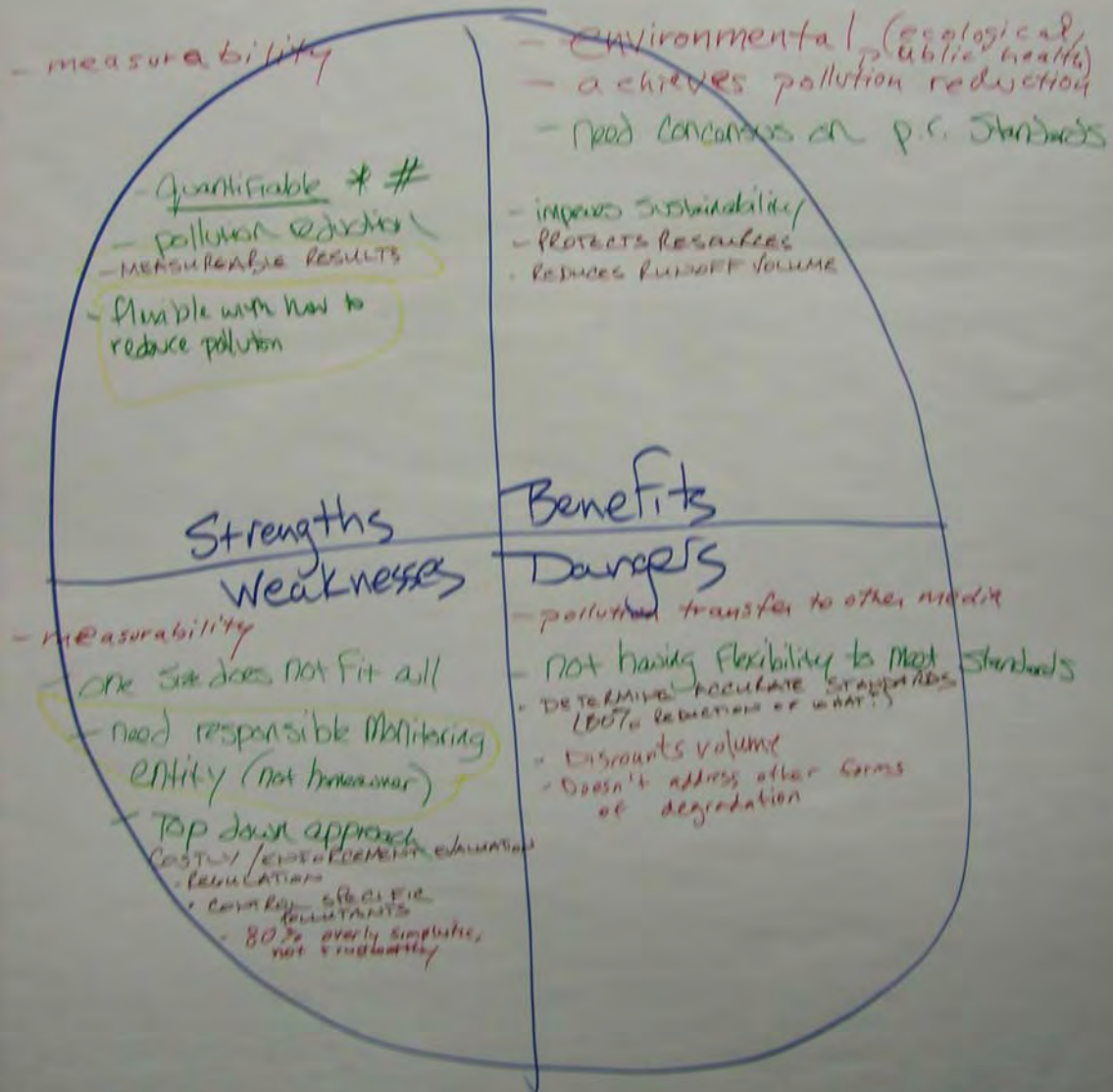



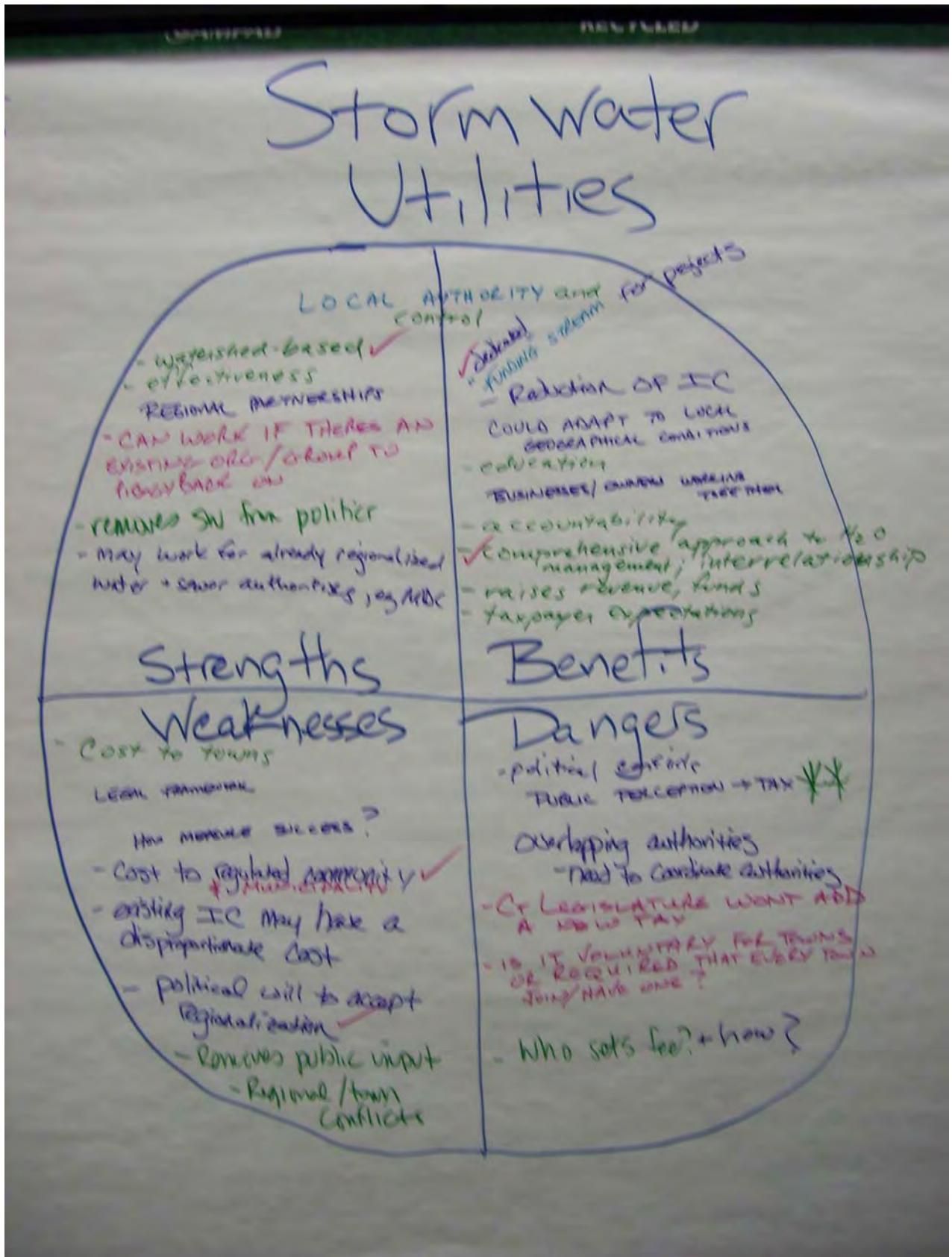

# ADDITIONAL ALTERNATIVES

No idea

HYBRID OF "5" ALTERNATIVES -

CURRENT APPROACH DOES NOT TRANSLATE  
TO ~~CITY~~ LOCAL LEVEL  
(SIMILAR TO HOW WETLANDS)

BOTTOM UP - DRIVEN BY TOWN

- COMPLIANCE w/ H<sub>2</sub>O-QUALITY STANDARDS
- + PUBLIC PARTICIPATION
- MANDATING RETROFITS
- EDUCATIONAL COMPONENT / PROGRAM  
- (officials, public)
- OTHER NON-STRUCTURAL CONTROLS  
(eg, street sweeping)
- STRICTER ENFORCEMENT
- make all P+Z follow same rules for stormwater management
- IC cap and trade
- Incentivize water reuse (ie. on water bill)

## **NEXT STEPS**

The next workshop will be held on **August 31 in the Phoenix Auditorium from 9:15 to 11:45 a.m.** This meeting will focus on alternatives for implementation. In preparation for the meeting Fuss & O'Neill will develop two technical memoranda regarding: (a) information gathered from partner interviews and other states; (b) the role of stormwater utilities. Fuss & O'Neill will also develop a summary document of alternatives for LID implementation and criteria for selection based on workshops 1 and 2.

## **ATTENDEES**

Attendees of the July 1 workshop are listed below in alphabetical order by affiliation.

<b>Attendee</b>	<b>Affiliation</b>
Eric Brown	CBIA
Virginia Mason	Council of Governments Central Naugatuck Valley
Jim Langlois	Connecticut Concrete
Matthew Hallssey	Connecticut Construction Industries
Jessica Morgan	Connecticut Department of Environmental Protection
Mary-Beth Hart	Connecticut Department of Environmental Protection OLISP
Chris Malik	Connecticut Department of Environmental Protection/NPS Program
MaryAnn Nusom Haverstock	Connecticut Department of Environmental Protection/NPS Program
Chris Stone	Connecticut Department of Environmental Protection- Water Permitting
Nisha Patel	Connecticut Department of Environmental Protection- Water Permitting
Eric McPhee	Connecticut Department of Public Health
Paul Corrente	Connecticut Department of Transportation—Environmental Planning
Roger Reynolds	Connecticut Fund for the Environment
John Carrier	Connecticut Home Builders
Mike Girard	Connecticut Home Builders
Darin Overton	Connecticut Home Builders

<b>Attendee</b>	<b>Affiliation</b>
Bruce Wittchen	Connecticut Office of Policy and Management
Judy Rondeau	ECCD
Johanna Hunter	EPA Region 1
Jim Riordan	Fuss & O'Neill
Phil Moreschi	Fuss & O'Neill
Bill Ethier	Home Builders Association of Connecticut
Terrance Gallagher	Luchs
Greg Sharp	Murtha Cullina, LLP
John Hudak	Regional Water Authority
Kenneth Wieland	Rivers Alliance
Michael Dietz	University of Connecticut—Nonpoint Education for Municipal Officials



ATTACHMENT 1  
RESULTS OF CARD STORMING FROM JULY 1, 2010 (WORKSHOP 2)

**Card Storming Question:**  
What are the features of good LID policy?

**Objective Card Storming Aim:**  
Identify criteria [for determining alternatives]

**Experiential Card Storming Aim:**  
Identify similarities [in participants ideas of good LID policy]

-  **Economic Market Viability**
- Cost effective options, not regulations
  - Enough incentive to achieve success
  - Recognize market demands for different development types (LID may not be for all)
  - Funding for implementation
  - Market/demand sensitivity
  - Effectiveness can be verified and maintenance is not cost prohibitive

-  **Education**
- Education component
  - Knowledgeable design engineers training, train
  - Use good science and knowledgeable people to make decisions
  - Public acceptance—meaning willingness to act a local/residential scale
  - Greatest behavior change Promote policies (regulatory and/or voluntary) that result in greatest behavior change

-  **Clear and Understandable**
- Clarity
  - Uniform statewide (standardized)
  - Make any guidance and/or standards simple. Make process certain.
  - LID policy at the local level to adopt, enforce, implement

-  **Practicability-Flexibility**
- Practical to implement and maintain
  - Not burdensome to individuals, easy to comply with
  - Maintenance required
  - Flexible
    - Consider site constraints
    - Consider project type
  - Flexible
  - Room for innovation
  - Performance based (about objective, not technique)
  - Bottom-up site specific approach, not top down.

-  **Legal Administrable**
- Easy to administer
  - Aligning municipal zoning subdivision regulations (with LID)
  - Encouragement TPZ, cons[ervation] subdivision regulations
  - Available support structure mechanism for contractors/homeowners implementing LID
  - Compatible with other regulations and goals that are necessary i.e., ADA, mosquito control, public safety, public health
  - Legal
  - Oversight from local and state agencies
  - Enforceability
  - Treats stormwater runoff with the same strict criteria that are required of on-site septic systems
  - Quantifiable-measurable for other permit requirements that might duplicate
  - Should be expected and standard operating procedure not as the exception

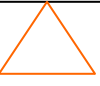
-  **Environmental Benefit**
- Manages soil erosion
  - Reduction of impervious materials
  - Remediates already built areas
  - Promotes GW recharge
  - Water quality & water quantity (groundwater (in-stream recharge) flow techniques)
  - Reduces runoff
  - Minimize impervious cover
  - Fix impairment
  - Resource based design (e.g., soils)
  - Allow soil microorganisms to work
  - Shift focus from engineering to conservation

ATTACHMENT 2  
RESULTS FROM CAROUSEL WORKSHOP JULY 1, 2010 (WORKSHOP 2)

Low Impact Development and Stormwater General Permit Evaluation

1. REGULATORY

STRENGTHS	BENEFITS
<ul style="list-style-type: none"> <li>-Experience</li> <li>-No free-rider/fairness</li> <li>-Effectiveness</li> <li>-People know clarity/uniformity (consistent standard) [Fix what you have]</li> <li>-Helps municipalities to justify requiring LID</li> <li>-Mandatory</li> </ul>	<ul style="list-style-type: none"> <li>-Invest in LID where you get the most benefit to fix the biggest problem</li> <li>-Ensure most LID use</li> <li>-Quantifiable (e.g., drainage calculations, apply to flood management)</li> <li>-Avoids externalizing costs</li> <li>-Public health – flood mitigation</li> <li>-Accountability</li> <li>-Transparency</li> <li>-Quick goal attainment</li> <li>-It will get LID implemented</li> </ul>
WEAKNESSES	DANGERS
<ul style="list-style-type: none"> <li>-Lack of experience</li> <li>-Flexibility for industry/towns</li> <li>-Problems for implementation at existing facilities (Retrofitting Q's)</li> <li>-Enforcement (staff) is a weakness</li> <li>-Difficult to be uniform – urban, suburban</li> <li>-How ensure compliance at local level?</li> <li>-Mandatory</li> <li>-Bureaucracy/cost</li> <li>-Not market viable</li> </ul>	<ul style="list-style-type: none"> <li>-State/municipal conflict ✓</li> <li>-Municipal ability to implement/knowledge</li> <li>-If permit – applicant knowledge</li> <li>-Carved into marble</li> <li>-Hard to modify if flaws identified</li> <li>-Limited enforcement</li> <li>-If not enough flexibility, will get resistance ✓</li> <li>-Not applicable on every site</li> </ul>

2. NON REGULATORY

STRENGTHS	BENEFITS
<ul style="list-style-type: none"> <li>-Behavioral change</li> <li>-Politically palatable</li> <li>-Flexibility, Financial Benefit for small contractor/operator</li> <li>-Keeps options open</li> <li>-Educates public and encourages voluntary buy-in</li> <li>-Flexible</li> <li>-Larger buy-in across the board</li> </ul>	<ul style="list-style-type: none"> <li>-Training and education</li> <li>-Demo projects</li> <li>-CT should fund demo projects and cost</li> <li>-Private funding sources</li> <li>-Proper guidance will lead to good design and environmental benefits, will follow</li> <li>-Economic development</li> <li>-Experimentation</li> <li>-With strong incentives, this approach could work</li> </ul>
WEAKNESSES	DANGERS
<ul style="list-style-type: none"> <li>-Non regulatory may not be implemented</li> <li>-Funding is difficult/wouldn't be priority as non regulated</li> <li>-Provides no incentive for LID in meeting other regulatory requirements (e.g., FMC)</li> <li>-Costs can be externalized (people have choice to opt out and costs are paid by others)</li> <li>-Causes uncertainty for local boards/commissions</li> <li>-Failure to comply with CWA</li> <li>-Non-measurable or predictable</li> <li>-No consistent application of LID</li> <li>-At odds with current regulations</li> </ul>	<ul style="list-style-type: none"> <li>-Political process</li> <li>-Consistency</li> <li>-Need for incentives for developers</li> <li>-Becomes a low priority</li> <li>-Free-rider</li> <li>-Status quo – what we have now</li> <li>-Failure to comply</li> </ul>

3. PERFORMANCE STANDARD

STRENGTHS	BENEFITS
<ul style="list-style-type: none"> <li>-Flexible design</li> <li>-Using simple performance standards works well (i.e., 1" GW recharge)</li> <li>-If you met the standard, you meet it</li> <li>-Backed up by science</li> <li>-Uniform</li> <li>-Measurability</li> <li>-Quantifiable</li> </ul>	<ul style="list-style-type: none"> <li>-Could be regulatory or non-regulatory</li> <li>-Flexible menu ** (menu of options to meet standards)</li> <li>-BMPs can be fine-tuned (cost-effective)</li> <li>-Enforceable/achievable</li> <li>-Easy to monitor (volume-based standard)</li> </ul>
WEAKNESSES	DANGERS
<ul style="list-style-type: none"> <li>-Not clear - Inconsistent application of BMPs</li> <li>-Implementation needs to be simple or costs rise quickly</li> <li>-Timeline – What's long term enforcement</li> <li>-How to set the standard</li> <li>-Municipal staff/time training</li> <li>-Administrative burden</li> <li>-Site-specific design</li> <li>-Lack of data on performance in practice</li> <li>-Measurability</li> </ul>	<ul style="list-style-type: none"> <li>-Ultra-conservative; may add unnecessary expense</li> <li>-Failure of BMPs</li> <li>-Avoid one size fits all</li> <li>-Conflicts with best engineering judgment</li> <li>-Discourages innovation</li> </ul>

4. POLLUTION REDUCTION

STRENGTHS	BENEFITS
<ul style="list-style-type: none"> <li>-Measurability</li> <li>-Quantifiable *#</li> <li>-Pollution reduction</li> <li>-Measureable results</li> <li>-Flexible with how to reduce pollution</li> </ul>	<ul style="list-style-type: none"> <li>-Environmental (ecological/public health)</li> <li>-Achieves pollution reduction</li> <li>-Need consensus on p.r. [pollution reduction] standards</li> <li>-Improves sustainability</li> <li>-Protects resources</li> <li>-Reduces runoff volume</li> </ul>
WEAKNESSES	DANGERS
<ul style="list-style-type: none"> <li>-Measurability</li> <li>-One size does not fit all</li> <li>-Need responsible monitoring entity (not homeowner)</li> <li>-Top down approach</li> <li>-Costly/enforcement evaluation – regulation</li> <li>-Control specific pollutants</li> <li>-80% overly simplistic, not trustworthy</li> </ul>	<ul style="list-style-type: none"> <li>-Pollution transfer to other media</li> <li>-Not having flexibility to meet standards</li> <li>-Determine accurate standards (80% reduction of what?)</li> <li>-Discounts volume</li> <li>-Doesn't address other forms of degradation</li> </ul>

5. STORMWATER UTILITIES

STRENGTHS	BENEFITS
<ul style="list-style-type: none"> <li>-Watershed based ✓</li> <li>-Effectiveness</li> <li>-Regional partnerships</li> <li>-Can work if there's an existing organization/group to piggyback on</li> <li>-Removes stormwater from politics</li> <li>-May work for already regionalized water and sewer authorities, e.g., MDC</li> </ul>	<ul style="list-style-type: none"> <li>-Dedicated "funding" stream for projects</li> <li>-Reduction of IC [Impervious cover]</li> <li>-Could adapt to local geographical conditions</li> <li>-Education</li> <li>-Businesses/owners working together</li> <li>-Accountability</li> <li>-Comprehensive approach to water management, interrelationship</li> <li>-Raises revenue, funds</li> <li>-Taxpayer expectations</li> </ul>
WEAKNESSES	DANGERS
<ul style="list-style-type: none"> <li>-Cost to towns</li> <li>-Legal framework</li> <li>-How measure success?</li> <li>-Cost to regulated community and municipality</li> <li>-Existing IC may have a disproportionate cost</li> <li>-Political will to accept regionalization ✓</li> <li>-Removes public input</li> <li>-Regional/town conflicts</li> </ul>	<ul style="list-style-type: none"> <li>-Political conflicts</li> <li>-Public perception – tax**</li> <li>-Overlapping authorities – Need to coordinate authorities</li> <li>-CT legislature won't add a new tax</li> <li>-Is it voluntary for towns or required that every town join/have one?</li> <li>-Who sets fee and how?</li> </ul>

6. ADDITIONAL ALTERNATIVES

<ul style="list-style-type: none"> <li>-Hybrid of "5" alternatives – current approach does not translate to local level (similar to how wetlands) Bottom up- driven by town.</li> <li>-Compliance with water quality standards</li> <li>-Public participation</li> <li>-Mandating retrofits</li> <li>-Educational component/program (officials, public)</li> <li>-Other non-structural controls (e.g., street sweeping)</li> <li>-Stricter enforcement</li> <li>-Make all P+Z [planning and zoning] follow same rules for stormwater management</li> <li>-IC [impervious cover] cap and trade</li> <li>-Incentivize water reuse (i.e., on water bill)</li> </ul>
--



## 1. REGULATORY

STRENGTHS	BENEFITS
<ul style="list-style-type: none"> <li>•Experience</li> <li>•No free-rider/fairness</li> <li>•Effectiveness</li> <li>•People know clarity/uniformity (consistent standard) [Fix what you have]</li> <li>•Helps municipalities to justify requiring LID</li> <li>•Mandatory</li> </ul>	<ul style="list-style-type: none"> <li>•Invest in LID where you get the most benefit to fix the biggest problem</li> <li>•Ensure most LID use</li> <li>•~Quantifiable (e.g., drainage calculations, apply to flood management)</li> <li>•Avoids externalizing costs</li> <li>•Public health – flood mitigation</li> <li>•Accountability</li> <li>•Transparency</li> <li>•Quick goal attainment</li> <li>•It will get LID implemented</li> </ul>
WEAKNESSES	DANGERS
<ul style="list-style-type: none"> <li>•Lack of experience</li> <li>•Flexibility for industry/towns</li> <li>•Problems for implementation at existing facilities (Retrofitting Q's)</li> <li>•Enforcement (staff) is a weakness</li> <li>•Difficult to be uniform – urban, suburban</li> <li>•How ensure compliance at local level?</li> <li>•Mandatory</li> <li>•Bureaucracy/cost</li> <li>•Not market viable</li> </ul>	<ul style="list-style-type: none"> <li>•State/municipal conflict ✓</li> <li>•Municipal ability to implement/knowledge</li> <li>•If permit – applicant knowledge</li> <li>•Carved into marble</li> <li>•Hard to modify if flaws identified</li> <li>•Limited enforcement</li> <li>•If not enough flexibility, will get resistance ✓</li> <li>•Not applicable on every site</li> </ul>

## 2. NON REGULATORY

STRENGTHS	BENEFITS
<p>WEAKNESSES</p> <ul style="list-style-type: none"> <li>•*Non regulatory may not be implemented (Staff and resources)</li> <li>•Funding is difficult/wouldn't be priority as non regulated</li> <li>•Provides no incentive for LID in meeting other regulatory requirements (e.g., FMC)</li> <li>•Costs can be externalized (people have choice to opt out and costs are paid by others)</li> <li>•Causes uncertainty for local boards/commissions</li> <li>•Failure to comply with CWA</li> <li>•Non-measureable or predictable</li> <li>•No consistent application of LID</li> <li>•At odds with current regulations</li> </ul>	<p>DANGERS</p> <ul style="list-style-type: none"> <li>•Political process</li> <li>•Consistency</li> <li>•Need for incentives for developers</li> <li>•Becomes a low priority</li> <li>•Free-rider</li> <li>•Status quo – what we have now</li> <li>•Failure to comply</li> </ul>

### 3. PERFORMANCE STANDARDS

STRENGTHS	BENEFITS
<ul style="list-style-type: none"> <li>•Flexible design</li> <li>•Using simple performance standards works well (i.e., 1" GW recharge)</li> <li>•If you met the standard, you meet it</li> <li>•Backed up by science</li> <li>•Uniform</li> <li>•Measurability</li> <li>•Quantifiable</li> </ul>	<ul style="list-style-type: none"> <li>•Could be regulatory or non-regulatory</li> <li>•Flexible menu ** (menu of options to meet standards)</li> <li>•BMPs can be fine-tuned (cost-effective)</li> <li>•Enforceable/achievable</li> <li>•Easy to monitor (volume-based standard)</li> </ul>
WEAKNESSES	DANGERS
<ul style="list-style-type: none"> <li>•Not clear - Inconsistent application of BMPs</li> <li>•Implementation needs to be simple or costs rise quickly</li> <li>•Timeline – What's long term enforcement</li> <li>•How to set the standard</li> <li>•Municipal staff/time training</li> <li>•Administrative burden</li> <li>•Site-specific design</li> <li>•Lack of data on performance in practice</li> <li>•Measurability</li> </ul>	<ul style="list-style-type: none"> <li>•Ultra-conservative; may add unnecessary expense</li> <li>•Failure of BMPs</li> <li>•Avoid one size fits all</li> <li>•Conflicts with best engineering judgment</li> <li>•Discourages innovation</li> </ul>



## 4. POLLUTION REDUCTION

STRENGTHS	BENEFITS
<ul style="list-style-type: none"> <li>•Measurability</li> <li>•Quantifiable *#</li> <li>•Pollution reduction</li> <li>•Measureable results</li> <li>•Flexible with how to reduce pollution</li> </ul>	<ul style="list-style-type: none"> <li>•Environmental (ecological/public health)</li> <li>•Achieves pollution reduction</li> <li>•Need consensus on p.r. [pollution reduction] standards</li> <li>•Improves sustainability</li> <li>•Protects resources</li> <li>•Reduces runoff volume</li> </ul>
WEAKNESSES	DANGERS
<ul style="list-style-type: none"> <li>•Measurability</li> <li>•One size does not fit all</li> <li>•Need responsible monitoring entity (not homeowner)</li> <li>•Top down approach</li> <li>•Costly/enforcement evaluation – regulation</li> <li>•Control specific pollutants</li> <li>•80% overly simplistic, not trustworthy</li> </ul>	<ul style="list-style-type: none"> <li>•Pollution transfer to other media</li> <li>•Not having flexibility to meet standards</li> <li>•Determine accurate standards (80% reduction of what?)</li> <li>•Discounts volume</li> <li>•Doesn't address other forms of degradation</li> </ul>

## 5. STORMWATER UTILITIES

STRENGTHS	BENEFITS
<p style="text-align: right; color: green;">Local authority</p> <ul style="list-style-type: none"> <li>•Watershed based ✓</li> <li>•Effectiveness</li> <li>•Regional partnerships</li> <li>•Can work if there's an existing organization/group to piggyback on</li> <li>•Removes stormwater from politics</li> <li>•May work for already regionalized water and sewer authorities , e.g., MDC</li> </ul>	<p>and control</p> <ul style="list-style-type: none"> <li>•✓Dedicated "funding" stream for projects</li> <li>•Reduction of IC [impervious cover]</li> <li>•Could adapt to local geographical conditions</li> <li>•Education</li> <li>•Businesses/owners working together</li> <li>•Accountability</li> <li>•✓Comprehensive approach to water management; interrelationship</li> <li>•Raises revue, funds</li> <li>•Taxpayer expectations</li> </ul>
WEAKNESSES	DANGERS
<ul style="list-style-type: none"> <li>•Cost to towns</li> <li>•Legal framework</li> <li>•How measure success?</li> <li>•Cost to regulated community ✓ and municipality</li> <li>•Existing IC may have a disproportionate cost</li> <li>•Political will to accept regionalization ✓</li> <li>•Removes public input</li> <li>•Regional/town conflicts</li> </ul>	<ul style="list-style-type: none"> <li>•Political conflicts</li> <li>•Public perception – tax**</li> <li>•Overlapping authorities – Need to coordinate authorities</li> <li>•CT legislature won't add a new tax</li> <li>•Is it voluntary for towns or required that every town join/have one?</li> <li>•Who sets fee and how?</li> </ul>



## 6. ADDITIONAL ALTERNATIVES

- Hybrid of “5” alternatives – current approach does not translate to local level (similar to how wetlands) Bottom up- driven by town.
- Compliance with water quality standards
- Public participation
- Mandating retrofits
- Educational component/program (officials, public)
- Other non-structural controls (e.g., street sweeping)
- Stricter enforcement
- Make all P+Z [planning and zoning] follow same rules for stormwater management
- IC [impervious cover] cap and trade
- Incentivize water reuse (i.e., on water bill)

---

## **Appendix E**

### Summary of Workshop 3

**MEETING SUMMARY NOTES**  
**EVALUATION OF STORMWATER GENERAL PERMIT AND LID**  
**(Contract # PS2010-10172)**  
**WORKSHOP 3—AUGUST 31, 2010; PHOENIX AUDITORIUM**

DISTRIBUTION: Attendees and Other Project Partners  
DATE: October 12, 2010

---

The following discussion summarizes the August 31, 2010 Workshop for the Evaluation of Stormwater General Permit and Low-Impact Development held at the Department of Environmental Protection Offices (79 Elm Street, Hartford, CT) in the Phoenix Auditorium.

A list of **workshop attendees** is provided at the end of this summary.

## INTRODUCTIONS

### *Opening Remarks*

MaryAnn Nusom Haverstock opened the meeting. She then turned the agenda over to Fuss & O'Neill.

### *Introductions around the Table*

Jim Riordan of Fuss & O'Neill gave a PowerPoint Presentation, entitled "Introductions, Meetings, and the Web Page."

### *Future Meeting Dates and Locations*

Jim reconfirmed the next two meetings and meeting dates, which were set during Workshop 1 (May 26). The dates are as follows:

### **Project Meeting Dates**

<b>Workshop Title</b>	<b>Date to be Held</b>
Partner Workshop 4	Wednesday, October 20, 2010
Partner Workshop 5	Wednesday, December 15, 2010

### Note:

*All meetings will be held from 9:15 a.m. – 11:45 a.m. in the Phoenix Auditorium at the Hartford, CT DEP Offices.*

### *Web Page*

Jim reintroduced the project web page on DEP's website:

[http://www.ct.gov/dep/cwp/view.asp?a=2719&q=459488&depNav\\_GID=1654](http://www.ct.gov/dep/cwp/view.asp?a=2719&q=459488&depNav_GID=1654)

The web page continues to be used to provide project partners and other interested parties with general project information, schedules, and deliverables.

## REVIEW OF TECHNICAL MEMORANDA (TM) 1 AND 2

Jim led a review of TM 1 and 2, entitled respectively as follows:

- *Identification of Approaches for Including Low Impact Development and Pollution Prevention in General Permits*
- *Evaluating the Role of Stormwater Utility Districts in the Implementation of Low Impact Development*

This was followed by an open discussion of the two technical memoranda. Participants made the following comments during the open discussion:

- Federal Department of Defense has developed a LID guidance [*Unified Facilities Criteria (UFC) Low Impact Development Manual*] that may be helpful in determining accomplishment of water quality/quantity goals.
- We should provide performance goals and then give development flexibility to make applications to achieve the goals.
- Pollution prevention should be used to minimize volume of runoff at the source because prevention will reduce pollution and the amount of runoff to manage.
- Legislation has been proposed to issue bonds for stormwater utility operation and maintenance.
- Reimbursing a public utility when a roadway project presents a disturbance to a utility could impose a big expense on the state Department of Transportation.
- Municipalities have the ability to impose utility fees on sanitary sewers. This would be the same for stormwater utilities [if they were implemented]. Municipalities can install LID now and don't need a stormwater utility to do so. However, stormwater utilities could provide funding which will ensure ongoing maintenance, repairs and upgrades.

## RATIONALE FOR THE SELECTION OF TWO ALTERNATIVES

Jim provided an overview of *Summary 4 Rationale for Selection of Two Alternative Scenarios for Implementation*. The overview was followed by an open discussion of the summary document. Participants made the following comments:

- Question: Has DEP decided what regulatory approaches will be included?
  - Answer: Yes, to an extent. As part of the current project scope of work, DEP has decided to:
    - (a) develop LID standards that update the *Soil Erosion and Sediment Control Guidelines* and the *Stormwater Quality Manual*;
    - (b) include LID standards in the stormwater general permits.

The process for how this happens will be decided by the Partners. Other implementation elements, which may include regulatory approaches or nonregulatory approaches, will be determined by the Partners through the Partner Workshops.

- The LID standards in the stormwater manual should allow flexibility.
- If the standards are not mandatory, this could create conflict between towns.
- If percent impervious coverage of a watershed is regulated, there should be flexibility at the local level to decide where those impervious surfaces are located within the watershed.
- Standards should be defined, but use of LID on a specific site should be voluntary.
- Uniformity across communities in Connecticut is valuable and desirable.

## EXPLORING ALTERNATIVES—CAFE WORKSHOP

Jim introduced the café workshop with a PowerPoint presentation. The purpose of the workshop was to:

- Examine ideas about how alternatives work together
- Have an open dialog about alternatives
- Leverage collective knowledge
- Elicit innovation and good decision making



**Photograph 1**—Café workshop in process.

The café workshop included the following steps:

- Split into groups (about 4 to 6 people per group) and pick a “reporter.”
- Open café i.e., discussion about alternatives (20 minutes).
- Document results (10 minutes).
- Reporter presents findings and notes any new alternatives (2 minutes for each reporter).

Setup of each café workshop station (i.e., table) is diagramed in *figure 1* (right) and included multicolor markers, a paper “table cloth” for brainstorming and documentation, six seats.

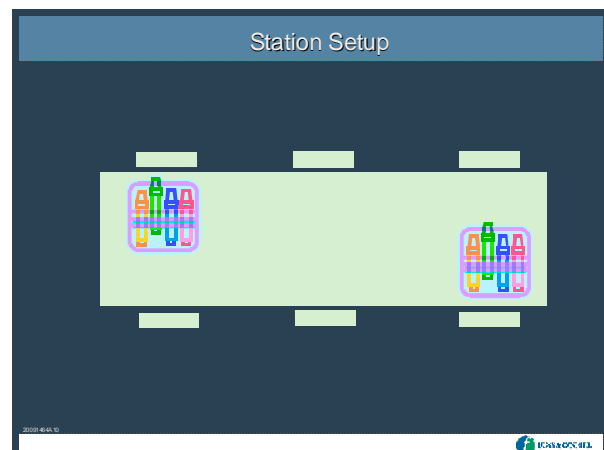

At the end of the café workshop, reporters reported results by group.<sup>1</sup> The written results on each “table cloth” are provided below:

<sup>1</sup> Groups were not actually named or numbered during the exercise.



Group 1

- Mix of reg & non-reg (essential)
  - Reg. necessary to establish goal
  - Non-reg necessary to establish education at all levels (b& c, town staff, citizens) and to create licensing programs to ease regulatory burdens
  - Unfunded mandate – free education to the regulated and regulators; tech assistance to municipalities and regulated
- Utility [politically] unlikely; but [would] create incentives to minimize resource allo[ca]tion to municipalities (post-development)
  - [Adopt] enabling authority so [that the utility] option [is] available
- Coordination with LEED program.

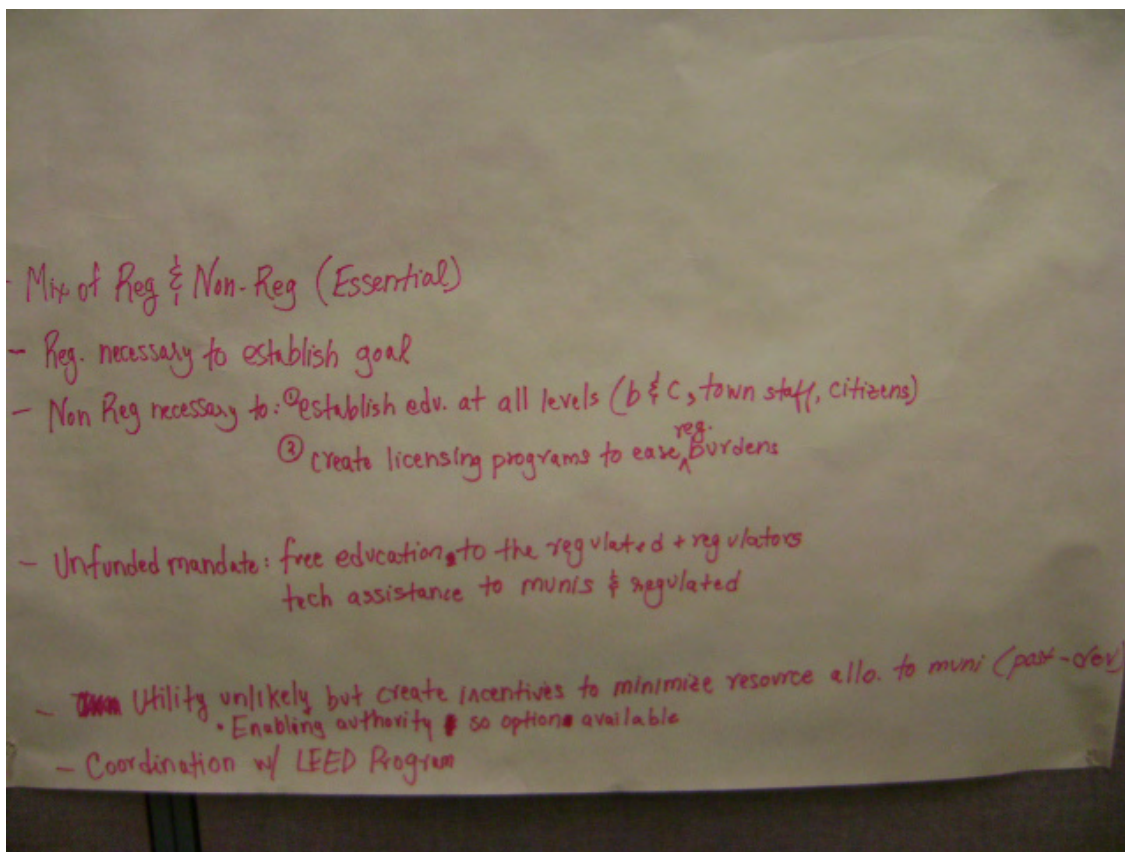

Group 2

- Hybrid of Incentives
- Designer License – Not appropriate at this point
- Cap & Trade - Not ready yet
- Update Manual – Needs to be site specific
- SGP – Include guide as reference

---

Group numbers are provided in this summary for the sole purpose of differentiating the reports from each group.

- Utilities – subcommittee down the road

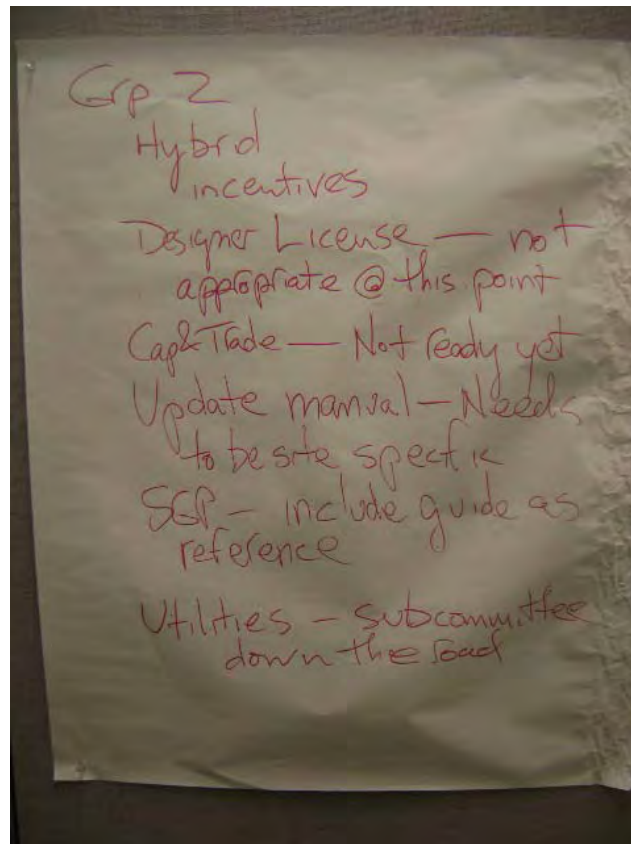

*Group 3*

- Regulatory Permit Process – with manual – BMPs, leaving design with site design
- Non-regulatory
  - Municipal certification and designer certification
  - Municipal training (I/W [inland wetlands] and P&Z [planning and zoning]-stormwater)
- Stormwater Utility (Parking Lot)
  - Potential future planning option – not a place to start
  - Political acceptance difficult
  - Geography
  - Success depends on area
  - ??
- Cap & Trade
  - How administered? How to set value of tradeable commodity/credits
  - Setting % of impervious surface – politically difficult
  - One size doesn't fit all – diff. sites even within watershed, have diff. needs
  - Façade for NIMBYism/controlling development.
  - Sending and receiving areas may have different environmental value

MANUAL

Regulatory  
Permit Process

- with financial review, using location design of site design
- Non-regulatory
- ✓ municipal certification
- ✓ designer certification
- ✓ municipal training  
EPA  
P&Z (common)

Stormwater utility  
(parking lots)

- Potential future planning option  
not a place to start
- Political acceptance difficult
- Geography
- Success depends on area

Cap + Trade

- How administered? How to set value of tradeable commodity/credits
- Setting % of Impervious Surface - Politically Difficult
- One size doesn't fit all - Diff. sites - even w/in watershed have diff. needs.
- Facade for NIMBYism/Controlling Dv/pt.
- Sending + Receiving Areas May Have Diff. Env'tl. Value

Group 4

- No rec. for UD at this time.
- Role of COG's in commissioners and town engineers' education or storm water utility districts?
- Regulatory – strong education component
- State of art changing so fast permitting needs to keep up with technology
- In permit – set pollutant goals and leave implementation open
- No utility districts
- Regulations need trade-off incentive
- Non Reg/reg spectrum
  - Permit – full LID requirement – Highest NO
  - Framework and manuals – mod Preferred
  - Recommend and manuals – least 2<sup>nd</sup> option
- Need big outreach and education

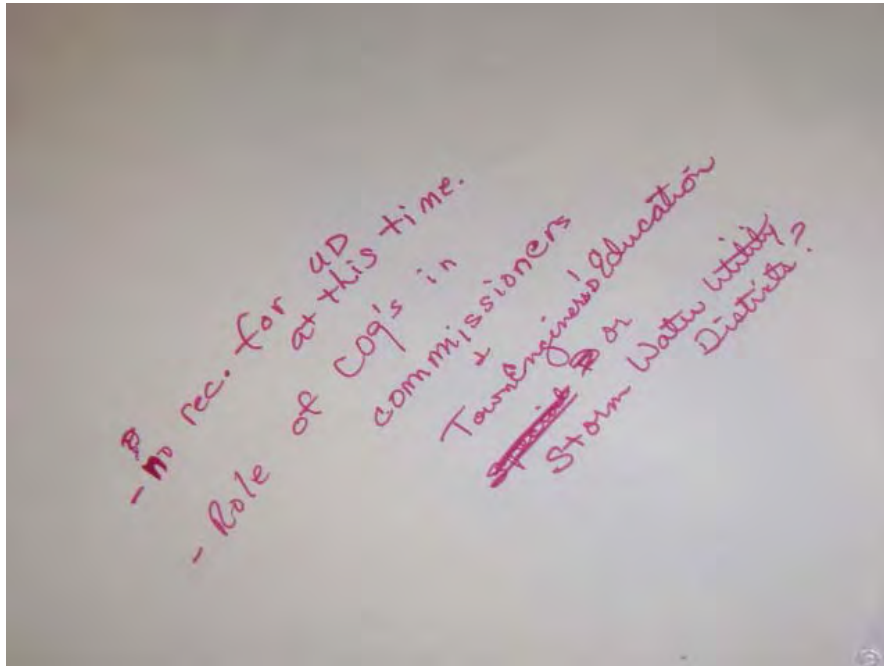



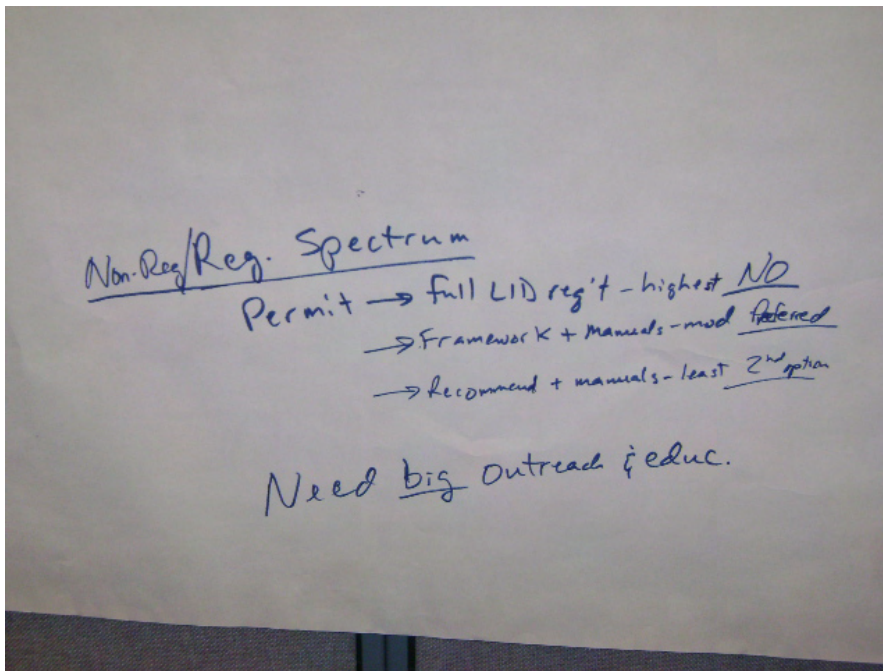
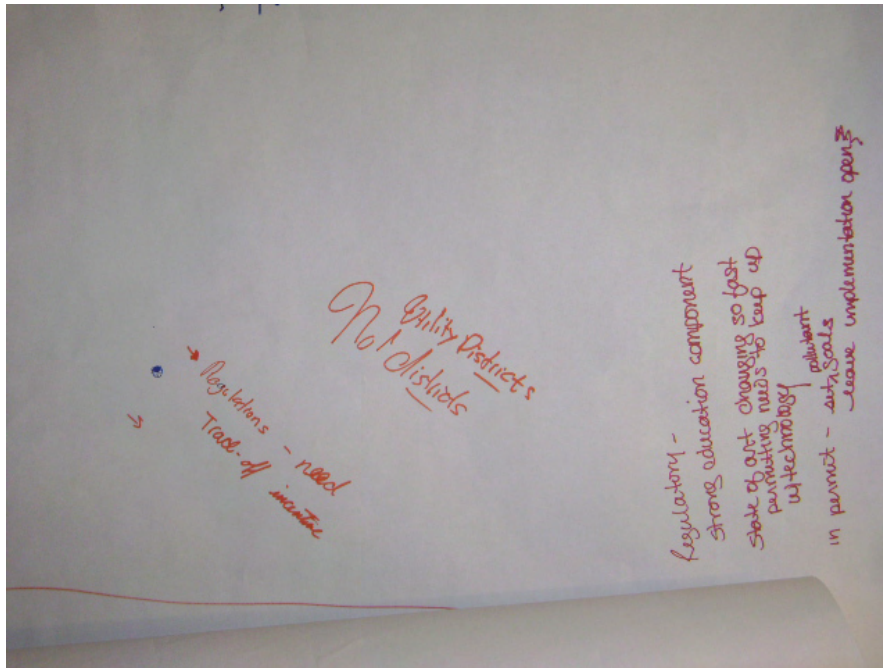

Group 5

- How to make regulatory economically viable?
  - Non-regulatory reward system similar to LEED or Green Circle
  - Fast tracking permits easier approval process (quick goal attainment)
  - Similar to certificates of permission?
- Environmental Benefits



- Regulatory would need to include widespread retrofits to make a big difference
- Smaller projects dealt with at local level
- Bigger projects at state level
- State/local conflict
  - Performance goal that needs to be met (pre & post)
  - Mandating LID could conflict with local regs
  - Solution: Have applicants explain why can't be implemented in towns.
- SW Utilities
  - Very political
  - Non-utility, stormwater utility option
  - Alternative to stormwater utility that is basically a utility but called something else to achieve same goals (funding for stormwater projects)
  - Funding stream solves real problems.
  - Flexible to towns

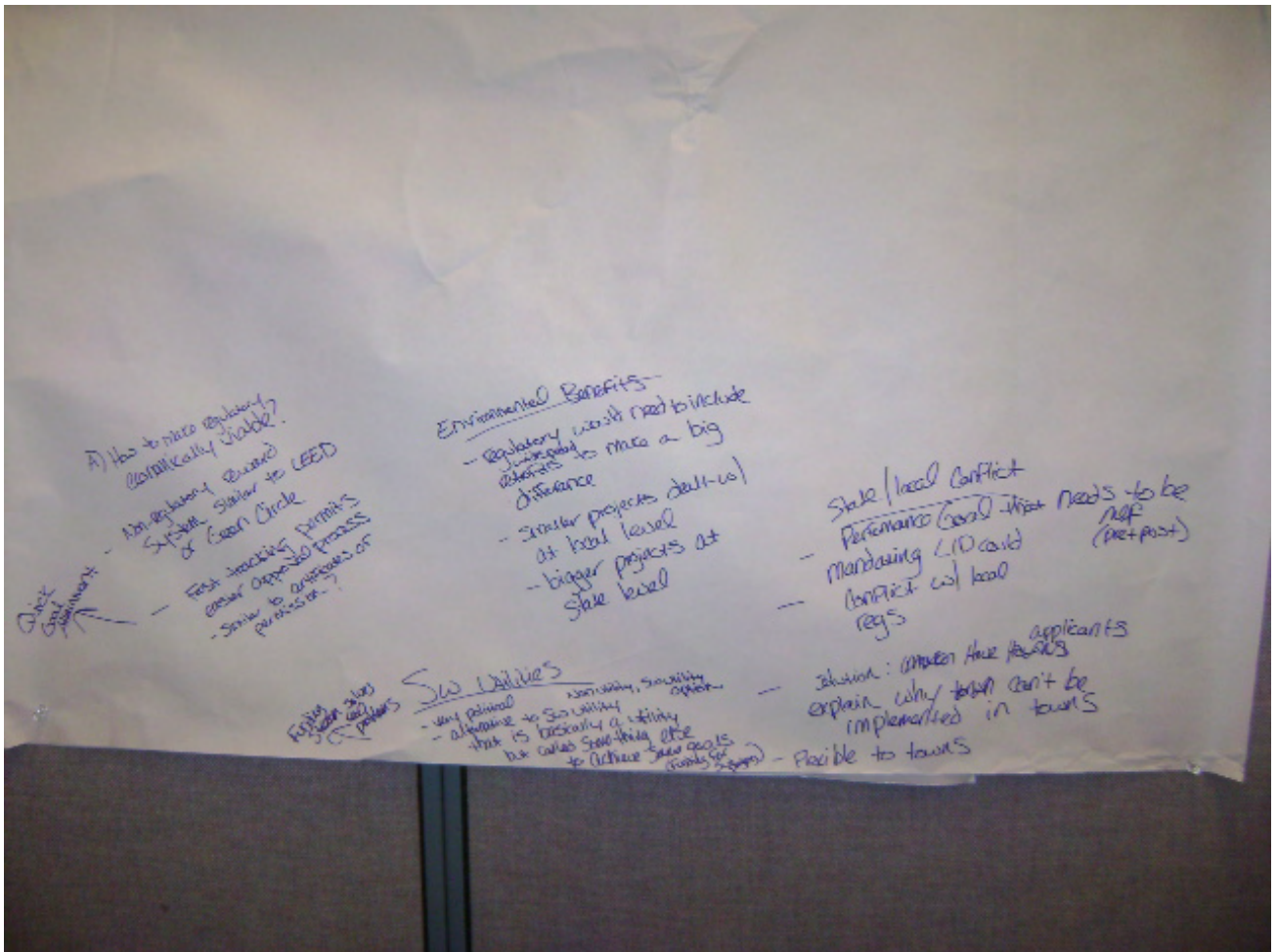

## IDENTIFYING PREFERRED ALTERNATIVES BASED ON CRITERIA—DOT VOTING USING A CRITERIA MATRIX

Jim gave a PowerPoint presentation introducing the dot-voting workshop using a criteria matrix. The purpose of the dot-voting workshop was to:

- Identify alternatives for immediate development
- Determine how alternatives compare with criteria
- Determine how alternatives fit best together when considering criteria



Photograph 2—Dot-voting workshop in process.

Dot voting included the following steps:

- Participants were each given 15 dots.
- Participants then identified which alternatives should be implemented first and which criteria they match by placing dots (5 minutes).
- Discuss results (10 minutes).

Dots were placed on a large paper sheet, which was set up as follows with alternatives on the vertical axis and criteria on the horizontal axis:

Dot-Voting Setup						
Alternative	Economically Viable	Knowledge-Based, Behavioral Change	Clear and Understandable	Practicable and Flexible	Administrable	Environmentally Beneficial
Update the Manual Guidelines						
Incorporating Standards into the SQP						
Designer licensing						
Imperious surface cap and trade		•••				
Adjusted standards for areas of special concern			••			
Training program			••			
Financial incentives	•					
Technical assistance						
Public education		••				
Stormwater Utility Subcommittee						
Guidance document						
Technical and financial assistance program						••
Public outreach and awareness toolbox						
Delegation of regulatory authority						
<b>Idea 1</b>						
<b>Idea 2</b>						
<b>Idea 3</b>						

20091464A.10

 FUSS & O'NEILL  
KEEP IT CLEAN

The results of the dot voting are shown below:



Tally of the dot votes by alternative and criteria is as follows:

**Tally from Dot Voting**

<b>Alternative</b>	<b>Economically Viable</b>	<b>Knowledge-Based, Behavioral Change</b>	<b>Clear and Understandable</b>	<b>Practicable and Flexible</b>	<b>Administrable</b>	<b>Environmentally Beneficial</b>
Update the Manual/Guidelines						
Incorporating Standards into the SGP						
Designer licensing	3	9		1	4	
Impervious surface cap and trade						2
Adjusted standards for areas of special concern	6	3		14	3	5
Training program	4	11	7	5	2	6
Financial incentives	18			2		6
Technical assistance	6	2	2	17	2	8
Public education	4	15	10	2		4
Stormwater Utility Subcommittee	15	1				6
Guidance document	1	3	14	3	2	8
Technical and financial assistance program	6	4			2	6
Public outreach and awareness toolbox	2	9	6	7		2
Delegation of regulatory authority	1			4	1	
LID Cert./Award	3	8		2	2	
Municipal Cert.	3	11	4			1
	72	76	43	57	18	54

17  
2  
31  
35  
26  
37  
35  
22  
31  
18  
26  
6  
15  
19



## NEXT STEPS

The next workshop will be held on **October 20 in the Phoenix Auditorium from 9:15 to 11:45 a.m.** This meeting will focus on LID standards and development of a LID guidance. In preparation for the meeting Fuss & O'Neill will develop a technical memorandum regarding alternatives for LID implementation and selection based on workshops 1 - 3. Fuss & O'Neill will also develop a summary document of LID standards.

## ATTENDEES

Attendees of the August 31 workshop are listed below in alphabetical order by affiliation.

<b>Attendee</b>	<b>Affiliation</b>
John Pagini	CCAPA [Connecticut Chapter of the American Planning Association]
Matthew Hallssey	Connecticut Construction Industries
Jessica Morgan	Connecticut Department of Environmental Protection
Mary-Beth Hart	Connecticut Department of Environmental Protection OLISP
Chris Malik	Connecticut Department of Environmental Protection/NPS Program
MaryAnn Nusom Haverstock	Connecticut Department of Environmental Protection/NPS Program
Rob Hust	Connecticut Department of Environmental Protection-Water & Permitting
Chris Stone	Connecticut Department of Environmental Protection-Water Permitting
Nisha Patel	Connecticut Department of Environmental Protection-Water Permitting
Eric McPhee	Connecticut Department of Public Health
Paul Corrente	Connecticut Department of Transportation—Environmental Planning
John Carrier	Connecticut Home Builders
Virginia Mason	Council of Governments Central Naugatuck Valley
Judy Rondeau	Eastern Connecticut Conservation District
Jim Riordan	Fuss & O'Neill



<b>Attendee</b>	<b>Affiliation</b>
Phil Moreschi	Fuss & O'Neill
Bill Ethier	Home Builders Association of Connecticut
Terrance Gallagher	Luchs
Greg Sharp	Murtha Cullina, LLP
Nicole Davis	South Western Regional Planning Agency

---

## **Appendix F**

### Summary of Workshop 4

MEETING SUMMARY NOTES  
EVALUATION OF STORMWATER GENERAL PERMIT AND LID  
(Contract # PS2010-10172)  
WORKSHOP 4—OCTOBER 20, 2010; PHOENIX AUDITORIUM

DISTRIBUTION: Attendees and Other Project Partners  
DATE: November 10, 2010

---

The following discussion summarizes the October 20, 2010 Workshop for the Evaluation of Stormwater General Permit and Low-Impact Development held at the Department of Environmental Protection Offices (79 Elm Street, Hartford, CT) in the Phoenix Auditorium.

A list of workshop attendees is provided at the end of this summary.

## INTRODUCTIONS

### *Opening Remarks*

MaryAnn Nusom Haverstock opened the meeting. She then turned the agenda over to Fuss & O'Neill.

### *Introductions around the Table*

Jim Riordan of Fuss & O'Neill gave a PowerPoint Presentation, entitled "Introductions, Meetings, and the Web Page."

### *Future Meeting Dates and Locations*

Jim reconfirmed the final meeting date, which was set during Workshop 1 (May 26). The date is as follows:

Partner Workshop 5                      Wednesday, December 15, 2010, 9:15 a.m. – 11:45 a.m.

### *Web Page*

Jim reintroduced the project web page on DEP's website:

[http://www.ct.gov/dep/cwp/view.asp?a=2719&q=459488&depNav\\_GID=1654](http://www.ct.gov/dep/cwp/view.asp?a=2719&q=459488&depNav_GID=1654)

The web page continues to be used to provide project partners and other interested parties with general project information, schedules, and deliverables. Meeting materials for Partner Workshop 4 are provided on the website.

## REVIEW OF TECHNICAL MEMORANDUM (TM) 3

Jim led a review of TM 3, entitled as follows:

- *Technical Memorandum 3: Rationale for Selection of Alternative Scenarios for Implementation*

This was followed by an open discussion of the technical memorandum. Participants made the following comments during the open discussion:

- Nisha Patel stated the Construction general permit (GP) draft will be out in one month and general guidance on LID will be adopted by October 1, 2011.
- Larry Coffman cautioned about potential for inconsistency between local regulations and SGP requirements for LID. Larry pointed out that top down regulation may result in resistance at the local level.
- One way to build flexibility into stormwater standards is to scale the standards based on the type of development.

## REVIEW OF SUMMARY 5 – LOW IMPACT DEVELOPMENT GUIDELINES AND STANDARDS

Jim Riordan and Larry Coffman provided an overview of *Summary 5: Low Impact Development Guidelines and Standards*. Larry Coffman presented the topic of LID design process and Jim Riordan presented the topics of proposed standards. The overview was followed by a group “design” activity and an open discussion.

## GROUP “DESIGN” ACTIVITY AND DISCUSSION—CAFE WORKSHOP

Jim introduced the café workshop with a PowerPoint presentation. The purpose of the workshop was to:

- Examine how the LID design process and standards might work in relation to:
  - Form of the LID Manual.
  - Giving LID Priority.
  - Incorporating Performance Goals and Criteria in General Permits.
  - Adjusted Standards for Areas of Concern.
- Have an open dialog about the design process and standards
  - Leverage collective knowledge
  - Elicit innovation and good decision making

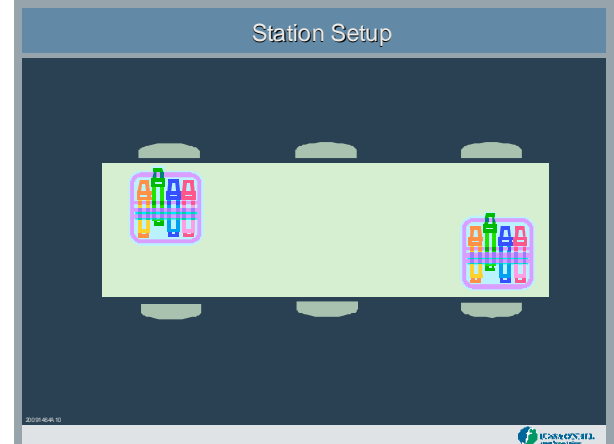

The café workshop included the following steps:

- Split into four groups (about 4 to 6 people per group) and pick a “reporter.”  
The four groups addressed the following issues:
  - Form of the LID Manual.
  - Giving LID Priority.
  - Incorporating Performance Goals and Criteria in General Permits.
  - Adjusted Standards for Areas of Concern.
- Open café i.e., discussion (20 minutes).

- Document results (10 minutes).
- Reporter presents findings (2 minutes for each reporter).

Setup of each café workshop station (i.e., table) is diagramed in *Figure 1* (previous page) and included multicolor markers, a paper “table cloth” for brainstorming and documentation, and six seats.

Each of the four groups were asked to consider the following five “design” scenarios during their discussion:

- Redevelopment or a highly urbanized setting
- New residential development
- New industrial or commercial development
- Development in a sensitive area
- Roadway projects

At the end of the café workshop, reporters reported results by group.<sup>1</sup> The written results on each “table cloth” are provided below:

#### Group 1:

- Numerical calculation is too arbitrary.
- Approach differs for different types of land uses.
- Urban retrofit is long-term [i.e., may take a long time to effectively implement].
- Urban retrofit and solutions require [that] municipal solutions are part of mix [i.e., also considered].
- Maximum extent practicable given site conditions – especially for new residential and industrial uses.
- Sensitive areas → maximum requirements.
- Roadways--maximum extent for new roads--trigger for reconstruction.
- Relationship between LID in SGP and local LID regulation (planning and zoning, etc.) need more thought/work.
- Do not know enough for defensible scale of different numerical standards for different types of development.

---

<sup>1</sup> Groups were not actually named or numbered during the exercise. Group numbers are provided in this summary for the sole purpose of differentiating the reports from each group.



1.) Numerical solution for arbitrary  
2.) Approach differs for different type of  
land uses.  
3.) Urban retrofit is long-term  
4.) Urban retrofit & solutions require  
municipal solutions are part of mix.  
5.) Maximum extent practical given  
site conditions. - especially for  
new residential, industrial.  
6.) Sensitive areas → max. requirements  
7.) Roadway - max. extent for new  
roads. - trigger for reconstruction

relationship btwn LID  
in SGP and local LID  
regulation (P+z, etc.) needs  
more thought/work.

don't know enough  
for defensible scale  
of different numerical  
standards for different  
types of development.

Group 2:

- Full rewrite
- SGP is integrative document
- Full rewrite – preferable
- Stormwater edits to E&S [*Soil Erosion and Sediment Control Guidelines*]
- Short term = standalone manual
- Since planning and zoning refers to both, may be appendix
- Long-term goal – full rewrite of SWQ [Stormwater Quality Manual] only
- Need interim goal – appendix or standalone
- Standalone
  - Pros:
    - Fastest
    - One source
    - Minimize conflicts
  - Cons:
    - A third manual
    - Potential confusion
- Appendix
  - Pros:
    - Faster
    - Piggybacks on existing manual
  - Cons:
    - How to reference
    - Change manual references
- Form
  - Timing is the issue
  - Develop a standalone (or appendix easier/preferred)
  - While seeking \$\$ [funding] to fully rewrite
- Standalone
- Appendix

Full rewrite - preferable  
Storm water  
Edits to E&S

---

short term = stand alone  
manual

- since P&Z refers to both  
may be appendix

Long-term goal - Full rewrite of SEAQ only  
need interim goal - Appendix or stand alone

Stand alone

PRO - fastest

- one source
- minimize conflicts

CON - a 3rd manual

- potential confusion

Appendix

PRO - faster

- piggybacks on existing manual

CON - how to reference

- change manual references

Form -

1.) Timing is the issue.  
Develop a stand alone (or appendix) while saving & to be prepared  
fully rewrite.

• STAND ALONE  
• APPENDIX  
• FULL REWRITE

SGP IS INTEGRATIVE DOC.

Group 3:

- Recharge goals
- Performance standards in SGP
  - Precise
  - Simple
  - Reasonable
  - Minimum



- Not specific LID standards
- Reference LID freestanding manual
  - Caveat: Depends on how it is written
- Soil erosion (flexibility)
- Need to advance/move up SGP consideration in entire permit process, so LID, etc., is considered upfront in initial design, not after planning, zoning, and conservation approval.
  - Easier done if LID is freestanding manual
- Need to coordinate – bring closer together the requirements/flexibility surrounding stormwater controls.

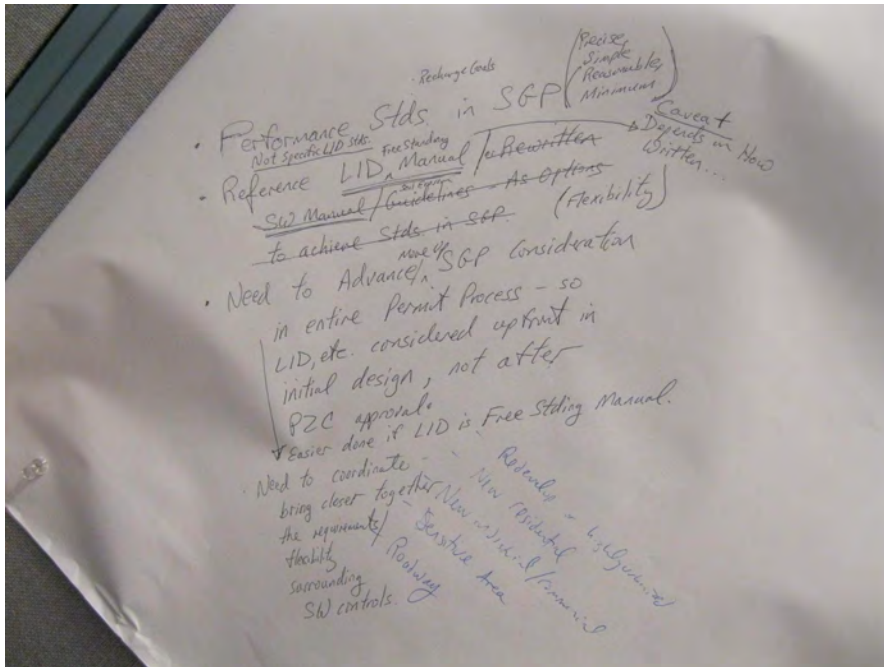

**Group 4:**

- Sensitive areas:
  - Buffers would be special requirements curb or gutter
  - Above and beyond
  - Increased water quality volume (More retention and more management)
  - MA and RI have upgraded
  - \*Define sensitive areas (anti-degradation?)
  - Aquifer protection
  - Potable water
  - Buffers increased
  - Additional setbacks
  - Increase water quality volume
  - Increase infiltration standard
- Redevelopment
  - Need for adjustment



- Not one size fits all
- DOT separate standards
- Upgrades – making it standard
- Standard – retain certain amount of volume
- Redevelopment has to prove standards they cannot meet
- Retain 1-inch.
- Meet standards
- Reduction percent from existing
  - Water Quality?
  - Infiltration?
  - LID?
  - Volume?

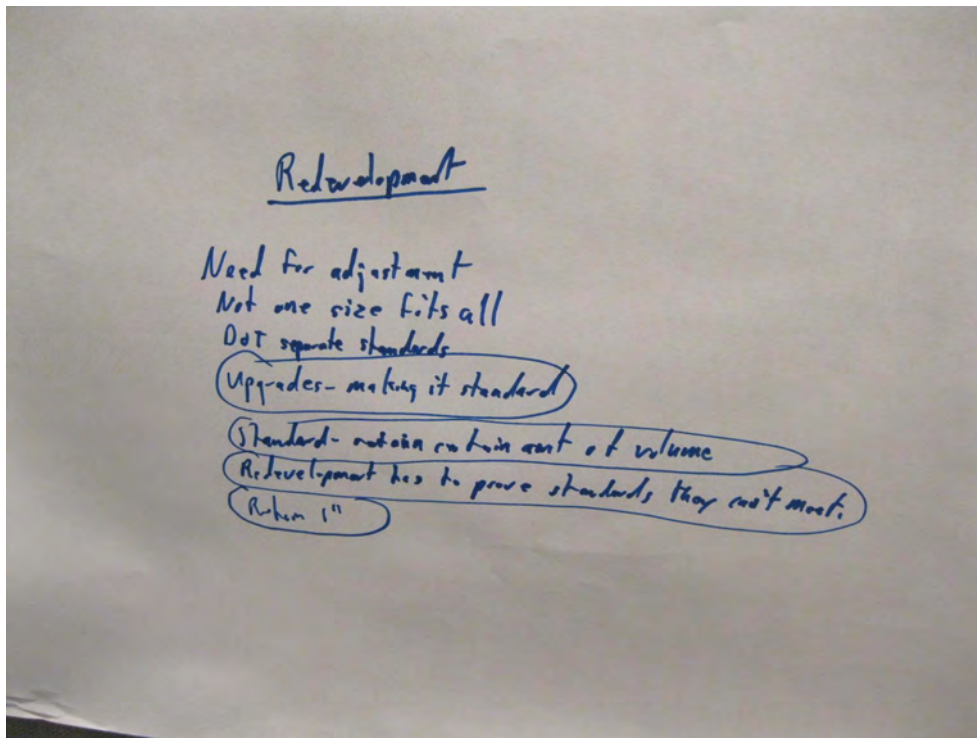

Redevelopment

- Meet standards
- Needs to prove why they may not be able to meet standards.

Sensitive Areas

- Buffers increased
- Additional setbacks
- increase WO volume
- increase infiltration standard

- WQ?  
- infil?  
- LID?  
- volume? } Reduction % from existing

\* Need to define sensitive areas

Sensitive Areas

Buffers would be - special requirements, curb or buffers  
Above & beyond  
Increased water quality volume. (more retention more management)

MA&RI has updated.  
~~Anti-degradation~~  
Define sensitive areas. (anti-degradation?)  
Aquifer protection  
→ potential water

## OPEN DISCUSSION

Jim led an open discussion/consensus covering the following topics:

- Incorporating performance goals and criteria into general permits
- Adjusted standards for areas of concern
- Form of the LID manual
- Giving LID priority

Attendees were presented with multiple options for implementing each topic and were asked to raise their hands for which option they preferred. Results of the consensus are provided below.

Topic and options for implementation	Consensus from Attendees
<i>Incorporating Performance Goals</i>	
LID Manual referenced in SGP	0
Incorporate Specific LID standards in SGP	0
LID Manual reference and standards in SGP (Performance)	16 (all)
LID Manual, but no reference in SGP	0
<i>Adjusted standards for areas of concern</i>	
Redevelopment	7
Sensitive Areas	15
DOT	8
<i>Form of Manual</i>	
Stand alone	0
Appendices	2
Full rewrite	4
Two-step approach(start with stand-alone manual, then prepare a full update of the full Stormwater Quality Manual at a later time)	12
<i>Giving LID Priority</i>	
Require a fraction of runoff as LID	7
Require a set aside	0
Use LID to the maximum extent practicable	10
Effective Impervious	5

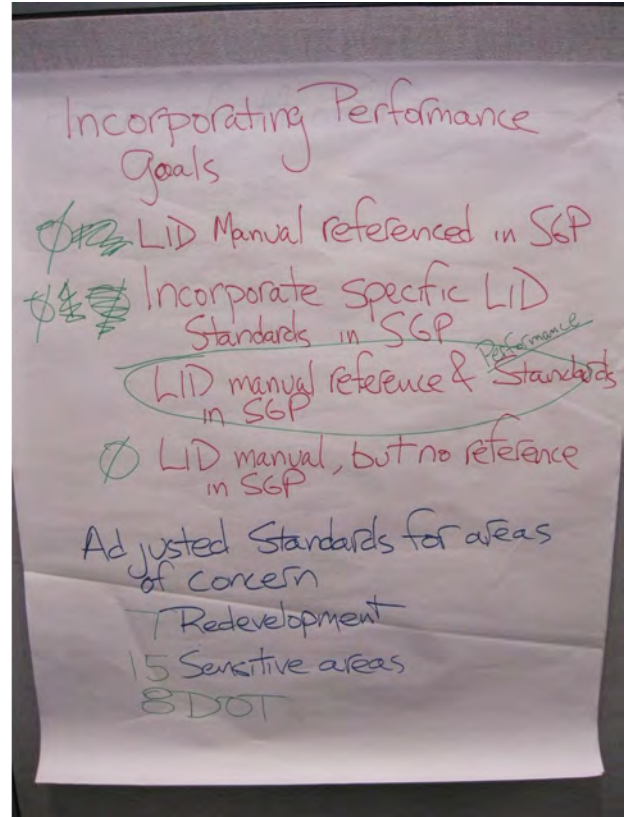
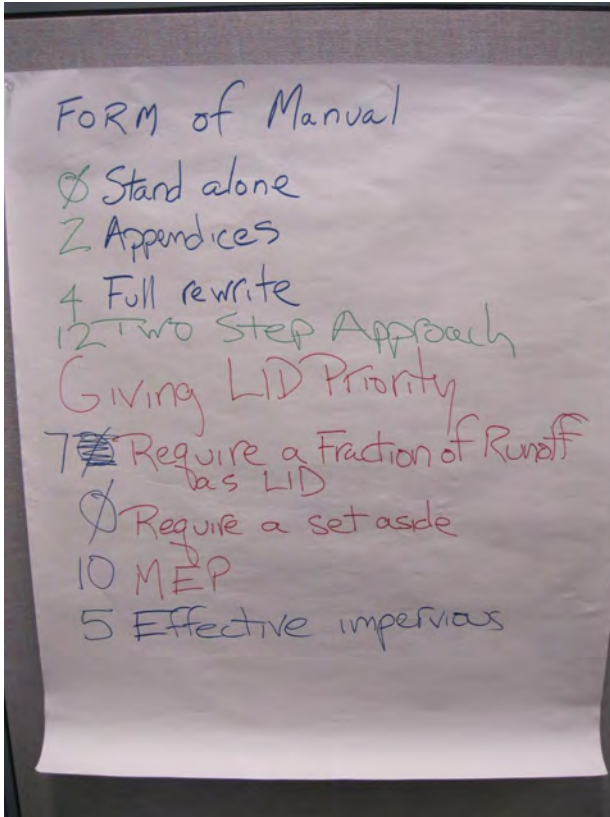

## PARTNER INVOLVEMENT AND IMPLEMENTATION

Due to time constraints, discussion of partner involvement and implementation has been deferred to Workshop 5 on December 15, 2010.

## NEXT STEPS

The next workshop will be held on December 15th in the Phoenix Auditorium from 9:15 to 11:45 a.m. This meeting will focus on the final draft report and partner involvement and implementation. In preparation for the meeting Fuss & O'Neill will develop a technical memorandum regarding LID standards and guidance and a draft final project report.

## ATTENDEES

Attendees of the October 20, 2010 workshop are listed below in alphabetical order by affiliation.

Attendee	Affiliation
Bill Ethier	Home Builders Association of Connecticut
Chris Malik	Connecticut Department of Environmental Protection-NPS Program
Chris Stone	Connecticut Department of Environmental Protection-Water Permitting
Cindy Baumann	CDM
Darin Overton	Connecticut Home Builders
Denise Savageau	Town of Greenwich
Greg Sharp	Murtha Cullina, LLP
Jim Riordan	Fuss & O'Neill
John Carrier	Connecticut Home Builders
John Pagini	CCAPA
Judy Rondeau	ECCD
Larry Coffman	LID Institute
MaryAnn Nusom Haverstock	Connecticut Department of Environmental Protection-NPS Program
Mary-Beth Hart	Connecticut Department of Environmental Protection OLISP
Michael Dietz	University of Connecticut—Nonpoint Education for Municipal Officials
Nisha Patel	Connecticut Department of Environmental Protection-Water Permitting
Phil Moreschi	Fuss & O'Neill
Roger Reynolds	Connecticut Fund for the Environment
Terrance Gallagher	Luchs



Virginia Mason	Council of Governments Central Naugatuck Valley
----------------	---

---

## **Appendix G**

### Summary of Workshop 5

(TO BE DEVELOPED)

## **Appendix H**

---

### State Interview Questionnaire

**Questionnaire**  
**Stormwater Program Managers from Other States**  
March 2010

*The purpose is to inform CTDEP's LID and SGP approach. These questions are expected to be asked in conversation; therefore, the results should not be considered "experimentally valid." To the extent that it is available, we will review each state's stormwater policy in advance of interviewing.*

**Introduction**

The State of Connecticut is conducting a project that will begin the process of including low-impact develop, or LID, into the following policy and guidance documents:

- General permits (MS4, construction, industrial, commercial)
- Stormwater design guidance materials
- Soil erosion design guidance materials

We're calling other states to explore approaches they may have used to incorporate LID into their stormwater policy and, in particular, their general permits.

1. Have you incorporated LID into the following policy and guidance documents?
  - a. General permits (MS4, construction, industrial, commercial)
  - b. Stormwater design guidance materials
  - c. Soil erosion design guidance materials
  - d. LID practices such as the following:
    - i. Minimizing site disturbance
    - ii. Working with site hydrology
    - iii. Minimizing and disconnecting impervious surface
    - iv. Applying small-scale BMPs
2. How was this done?
  - a. By reference to a document
  - b. Specific standards
    - i. Narrative standard
    - ii. Prescriptive design standard
    - iii. Numeric standard
    - iv. Performance standard
  - c. Other methods
  - d. Giving LID primacy over end-of-pipe
  - e. Do you use any of the following standards as a way to demonstrate the incorporation of LID?
    - i. Runoff volume
    - ii. Graduated permit limits for differently sized storms and runoff volumes
    - iii. Pollutant levels based on runoff volumes

iv. Performance criteria

3. Do you allow stormwater utility districts?
  - a. Do stormwater utility districts play a role in permitting?
    - i. Are they delegated regulatory functions?
    - ii. Do they function as qualified local programs?
    - iii. Are they otherwise used to facilitate compliance?
  - b. What advantages do you see available through stormwater utility districts?



## **Appendix I**

---

### **Partner Interview Questionnaire**

**Questionnaire  
Project Partners  
March 2010**

*The purpose of using this questionnaire is to gather data to inform CTDEP's LID and SGP approach. These questions are expected to be asked in conversation; therefore, the results should not be considered "experimentally valid."*

**Introduction**

DEP is conducting a project that will begin the process of including low-impact development, or LID, into the following policy and guidance documents:

- General permits (MS4, construction, industrial, commercial)
- Stormwater Quality Manual
- Soil Erosion Control Guidelines

The project will be partner driven. That is to say, members of the regulated community, non-governmental organizations, as well as representatives of regulatory agencies (the partners) are being asked to provide direction to the DEP to initiate the development of LID guidance and regulatory policy through workshops and review of work products. Partners will also be given the opportunity to help implement policy by developing and participating in an implementation work plan. In other words, DEP is asking you to define your own role in the process.

**Questions**

Fuss & O'Neill, as the consultant assisting the DEP, is contacting you for two reasons—to request your participation in the partnership and to discuss your initial ideas about how to build LID into DEP policy. This is intended to be a starting point so that we can plan a first partner workshop.

1. Are you familiar with LID practices? (If not, interviewer should provide some description. Also this is an opportunity to discuss aspects of LID that the interviewee may not be considering)
2. Have you been involved in their application on a project or in policy?
3. How do you think they should be incorporated into DEP policy?
  - a. By reference to a document
  - b. Specific standards
    - i. Narrative standard
    - ii. Prescriptive design standard
    - iii. Numeric standard
    - iv. Performance standard
  - c. Other methods
4. Should LID be the BMPs of choice over end-of-pipe management practices such as detention ponds? If so, how?

5. What sort of standards should we use as a way to demonstrate the incorporation of LID?
  - i. Runoff volume
  - ii. Graduated permit limits for differently sized storms and runoff volumes
  - iii. Pollutant levels based on runoff volumes
  - iv. Performance criteria
  
6. In some states stormwater utility districts charge a fee for service to oversee BMP design review, installation, operation and maintenance. What do you think of the ideas of using stormwater utility districts as a regulatory device?
  - a. Do you see stormwater utility districts playing a role in permitting?
    - i. Do you think they could reasonably be delegated regulatory functions?
    - ii. Do you think they could reasonably function as qualified local programs? That is programs that are allowed by DEP to implement the Phase II General Permit on behalf of MS4 operators.
    - iii. Do you think they could otherwise be used to facilitate compliance?
  
  - b. What advantages do you see available through stormwater utility districts?
  
7. What would you like your role to be in implementing LID as part of the SGP?
  - a. Developing and review technical standards
  - b. Developing policy
  - c. Engaging the involvement of a constituency
  - d. Public education
  - e. Training
  - f. As a qualified local program
  - g. Implementation of a stormwater utility district
  - h. Other
  - i. Are you willing to participate as a partner in this project by attending partner meetings and reviewing work products?
    - i. Are you the appropriate contact person for this project?
    - ii. Provide contact information

## **Appendix J**

---

### **ORL Research Report – Stormwater Utilities**

Storm Water Utilities  
2 of 10 document(s) retrieved



## OLR RESEARCH REPORT

December 8, 2004

2004-R-0895

### **STORM WATER UTILITIES**

By: Paul Frisman, Associate Analyst

You asked about the changes in state law needed to create a storm water utility. The Office of Legal Research is not authorized to issue legal opinions and this memo should not be considered one.

#### **SUMMARY**

A storm water utility is a special assessment district that imposes a user fee to fund storm water management. According to the Department of Environmental Protection (DEP), there are no storm water utilities in Connecticut, although Stonington is researching the issue.

Municipalities have only those powers granted to them by statute. State law does not now explicitly authorize the creation of municipal storm water districts, although the law does authorize towns to operate and maintain sewer and drainage systems, and to regulate the flow of surface water in some circumstances. The law also permits municipalities to establish Water Pollution Control Authorities (WPCAs), which also may regulate the flow of storm water in certain instances.

If the legislature wishes to encourage the creation of storm water utilities, it would probably be best to specifically authorize the formation of such a district. The legislature could authorize creation of independent storm water utilities or permit existing municipal boards, such as WPCAs and Municipal Flood and Erosion Control

Boards, to assume the duties of a storm water utility. The legislature also may wish to consider permitting several municipalities to join in a regional storm water utility district.

The ability of a particular municipality to establish a storm water utility also would depend on that town's own charter or ordinances.

#### **BACKGROUND ON THE STORM WATER PROGRAM**



Polluted storm water runoff is a leading cause of impairment of the nearly 40% of surveyed water bodies that do not meet federal water quality standards, according to the U. S. Environmental Protection Agency (EPA). Polluted runoff can destroy fish, wildlife and aquatic life habitats; threaten public health; and reduce aesthetic values. The National Pollutant Discharge Elimination System (NPDES) addresses the discharge of storm water from non-agricultural sources in two phases.

### ***NPDES Phase I***

Phase I regulates medium and large municipal separate storm water systems (generally serving populations of 100,000 or more) and nearly a dozen categories of industrial activity, including construction activity that disturbs five or more acres. According to DEP, Stamford was the only Connecticut city regulated under NPDES Phase I, which took effect in 1992.

### ***NPDES Phase II***

Phase II regulates small municipal separate storm sewer systems, and construction activity disturbing between one and five acres. DEP says 113 state municipalities fall under Phase II. These municipalities have until 2009 to implement storm water management programs that contain at least the following six control measures: (1) public education and outreach; (2) public participation; (3) illicit discharge detection and elimination; (4) construction storm water management; (5) post-construction storm water management; and (6) pollution prevention (also called “good housekeeping.”)

DEP issued a Phase II General Permit (attached) in January 2004. More information on this permit and its requirements is available at <http://www.dep.state.ct.us/wtr/stormwater/ms4index.htm>

## **WHAT IS A STORM WATER UTILITY?**

A storm water utility is a special assessment district that generates funding specifically for storm water management. It generates revenue through imposition of a user fee rather than a property tax. According to [this article](#) in the *Journal for Storm Water Quality Professionals*, the user fee can be used to support and maintain existing storm drain systems, development of drainage plans, flood control measures and water quality programs, administrative costs, and sometimes construction of major capital improvements. One advantage of a storm water utility is that its costs are borne only by people who benefit from it. Further information on storm water utilities can be found in this [Natural Resources Defense Council report](#).

For this report we look only at state statutes that permit a municipality to raise revenue through user fees, also called benefit assessments. We do not consider special taxing districts that raise revenue through property taxes. For more information on these special taxing districts, please see OLR Reports [98-R-0335](#) and [2003-R-0825](#), attached.

## **STATE LAW AND THE CREATION OF STORMWATER UTILITIES**

State law does not now explicitly authorize the creation of municipal storm water districts, although the law does authorize towns to operate and maintain sewer and drainage systems, and to regulate the flow of surface water in some circumstances (CGS § 7-148(c)(6)(B)). The law also permits municipalities to establish WPCAs, which also may

regulate the flow of storm water in certain instances (CGS § 7-247).

To eliminate any doubt about municipal authority to create such a district, the legislature might wish to specifically authorize the formation of such a district. The legislature could authorize creation of independent storm water utilities or permit existing municipal boards, such as WPCAs (CGS § 7-245 *et seq.*) and Municipal Flood and Erosion Control Boards (CGS § 25-84 *et seq.*) to assume the duties of a storm water utility.

It may also wish to consider authorizing several municipalities to join in a regional storm water utility district.

### ***Water Pollution Control Authorities (WPCA)***

Under CGS § 7-246(a) a municipality may designate as a WPCA a new or existing board, commission, or (except in town meeting towns) its legislative body. Among other things, a WPCA may:

- acquire, build and operate a sewer system;
- buy, condemn or otherwise acquire property it needs for a sewer system; and
- devise rules and regulations to operate and maintain the sewer system, including regulating or banning the discharge of any sewage or storm water runoff that may adversely affect it (CGS § 7-247).

State law also requires municipalities to establish WPCAs, regardless of any state law or local ordinance, when the DEP orders it to abate or control water pollution (CGS § 22a-458).

### ***Assessment of Benefits***

A WPCA may levy benefit assessments upon owners of land and buildings especially benefited by the acquisition or construction of a sewer system, regardless of whether the property abuts the system. The assessment may include a proportionate share of the cost of any part of the sewer system, including the cost of (1) preliminary studies and surveys, (2) detailed working plans and specifications, (3) acquiring land, property or any interest in them, (4) damage awards, (5) construction costs, (6) interest charges, (7) legal and other fees, and (8) any other expense incidental to the work. The WPCA may divide the territory benefited by the system into districts and levy assessments differently in each district.

In assessing benefits, the WPCA may consider the area, frontage, grand list valuation, and present or permitted use or classification of the benefited properties, and any other relevant factor. It must use assessment revenue only to acquire and build the sewer system, or for the payment of interest and principal on bonds or notes issued to finance its acquisition or construction. A WPCA may not levy an assessment for more than the benefit that accrues to the property (CGS § 7-249). OLR Report [95-R-1148](#), attached, contains more information on sewer assessments.

### ***Flood and Erosion Control Boards***

A municipal Flood and Erosion Control Board may plan, lay out, acquire, construct,

reconstruct, repair, maintain, supervise, or manage a flood or erosion control system. It may buy or condemn property it needs for such a system (CGS § 25-86), and finance it by issuing bonds, levying taxes, imposing special assessments, or any combination of these (CGS § 25-87).

### ***Special Assessments***

If a board elects to impose special assessments, it may divide the assessments among the owners of lands and buildings that especially benefit from its services, regardless of whether the property abuts the flood or erosion control system. The assessment may include a proportionate share of any expenses incidental to the completion of the floor or erosion control system, including fees and expenses of attorneys, engineers, and others; the costs of acquiring property; interest on securities, the cost of preparing maps and plans, and the cost of advertising or notification. It may divide the total territory to be benefited from the system into sections, and levy assessments against each section separately. The amount raised must be apportioned among the benefited properties based upon their area, street frontage, assessed valuation, present or permitted use, or any combination of these or other relevant factors. The assessment cannot be for more than the benefit to the property (CGS §§ 25-87 and 88).

### **STORM WATER UTILITY STUDY**

DEP has awarded Stonington a grant to examine state laws and local ordinances to determine the feasibility of developing a storm water utility in that town. Nicole Burnham, an engineer at the Cheshire consulting firm of Milone & MacBroom, says she expects to have a draft report prepared by the end of this year.

PF: ro