



FINAL REPORT

Prepared for:

Connecticut Department of Environmental Protection

Prepared by:

dKC – de la Torre Klausmeier Consulting

June 2008

Table of Contents

Executive Summary	2
1.0 Introduction.....	4
2.0 Observed Failure Rates for Gasoline Powered Vehicles	6
3.0 Observed Failure Rates for Diesel Powered Vehicles	23
4.0 Enforcement of Connecticut's I/M Program	25
5.0 Quality Assurance Audits	36
6.0 Analysis of Data from Remote Sensing Devices (RSD)	40
7.0 Assessment of OBD Testing Issues	52
8.0 2005 to 2007 Inspection Cycle Analysis	60
9.0 Future Program Enhancements	67
10.0 Conclusions.....	68
Appendix A: EPA Checklist.....	69
Appendix B: 2007 CT I/M Program Data	79
Appendix B: Table of Contents	80

Executive Summary

As required by the Clean Air Act Amendments of 1990, the Connecticut Department of Environmental Protection (DEP) in partnership with the Connecticut Department of Motor Vehicles (DMV) conducts periodic evaluations of its enhanced inspection and maintenance program (I/M). This report is being submitted in fulfillment of the requirements to provide annual and biennial reports per 40 CFR 51.366. This report addresses data collected from January 1, 2006 to December 31, 2007. The United States Environmental Protection Agency (EPA) provided a checklist (Appendix A), which identified the data elements to be included in this annual report. The data elements from 2006 were submitted to the EPA in 2007. The 2007 data elements are compiled in Appendix B and correspond to the indexing system used in EPA's checklist. Due to the structure of Connecticut's program, the following requirements of the attached checklist are not applicable: (a)(2)(xiii), (xiv), (xv), (xvi), (xvii), (xviii), (xx) and (5); (b)(3)(ii), and (iv); (4)(iii), (6), (7); (d)(3) and (4).

The vehicle inspection and maintenance program, designed to identify vehicles that emit pollutants that exceed acceptable standards and require such vehicles to get repaired, is an important part of the strategy to ensure that Connecticut is positioned to attain the National Ambient Air Quality Standard for Ozone. Connecticut's program, which dates back to 1983, has a long history of effectively reducing vehicle emissions and results in more emission reductions than any other state implemented reduction strategy. Current estimates indicate that in 2010, this program will result in approximately 19 of the 200 tons per day of air pollutant reductions that are included in Connecticut's 2007 Ozone Attainment Plan. The emission reductions resulting from this program are an integral part of our air quality attainment efforts and important as part of a balanced strategy that includes reductions from stationary, area and mobile source sectors.

In 2003, Connecticut implemented a new I/M program in which vehicles are tested in a decentralized network of approximately 300 inspection stations. The new program instituted OBDII testing for 1996 and newer vehicles. Additionally, enforcement in the new program was improved by moving from a window sticker enforcement action to one requiring successful emission testing in order to obtain vehicle registration. Connecticut's I/M program performance statistics for the 2006 and 2007 calendar year confirm that the program continues to perform at the levels established under the centralized program. This evaluation demonstrates that Connecticut's I/M program is well managed and effectively achieves the expected air quality benefits.

- Over 96% of the vehicles subject to the testing were in compliance with I/M program requirements for 2006 and 2007. The overall compliance rate in Connecticut exceeds the compliance rate assumed in Connecticut's I/M SIP. Connecticut actively investigates non-compliance and assesses a large number of fines for late registration.

- Approximately 8% of vehicles failed their initial emissions test. This percentage is similar to the statistics reported since 2004. Failure rates under the decentralized I/M program are equal to or higher than failure rates recorded under centralized I/M programs.
- DMV performs extensive quality assurance checks on the program. Overt and covert audits were conducted at all stations as part of an extensive anti-fraud program. Less than 0.3% of the tests in Connecticut are suspect. Connecticut's anti-fraud efforts are models for other programs.

DEP and DMV continue to evaluate Connecticut's I/M program to assure its effectiveness and air quality benefits. Following are preliminary findings of an assessment conducted by de la Torre Klausmeier Consulting, Inc. (dKC) of future options for Connecticut's program:

- Remote sensing data collected in Connecticut demonstrates that older vehicles without OBDII systems will contribute significant amounts of pollution now and in the future. Therefore, even though some states are dropping tailpipe tests, continuing tailpipe tests on pre-1996 vehicles in Connecticut's I/M program maintains the air quality benefits necessary due to Clean Air Act requirements and statutory restrictions.
- Connecticut exempts the newest four model years from I/M testing. Remote sensing demonstrates these vehicles have very low emissions. Continuing to exempt these newest four model years from I/M requirements does not significantly impact air quality.
- Remote sensing devices (RSD) cannot be used as an alternative to periodic I/M tests.
- Customer convenience can be enhanced by implementing innovative OBDII inspection strategies.

1.0 Introduction

This report presents an analysis of data collected in Connecticut's vehicle Inspection and Maintenance (I/M) program in 2006 and 2007 to meet the United States Environmental Protection Agency's (EPA) annual and biennial reporting requirements of 40 CFR Part 51.366. In an I/M program, vehicles are periodically inspected, and those with evidence that they exceed design emission standards must be repaired. I/M programs were mandated by the Clean Air Act for areas such as Connecticut that were designated as serious or severe non-attainment for ozone. Connecticut's program, which dates back to 1983, has a long history of effectively reducing vehicle emissions and is an important part of the strategy to ensure that Connecticut is positioned to attain the National Ambient Air Quality Standard for Ozone. Connecticut's I/M/ program results in more emission reductions than any other state implemented reduction strategy. Current estimates indicate that in 2010, this program will result in approximately 19 of the 200 tons per day of air pollutant reductions that are included in Connecticut's 2007 Ozone Attainment Plan. The emission reductions resulting from this program are an integral part of our air quality attainment efforts and important as part of a balanced strategy that includes reductions from stationary, area and mobile source sectors.

Connecticut's I/M program identifies vehicles that have been tampered or have received improper maintenance. These vehicles must be repaired until they comply with emission standards. The Connecticut Department of Motor Vehicles (DMV) manages the I/M program; the Connecticut Department of Environmental Protection (DEP) ensures that the program achieves the air quality benefits as outlined in Connecticut's State Implementation Plan (SIP).

The original program implemented in 1983 subjected vehicles to two inspections – an idle test where exhaust concentrations of hydrocarbons (HC) and carbon monoxide (CO) were measured while the vehicle was idling and a visual inspection for the presence of emission control devices, such as the catalytic converter. Vehicles with gross vehicle weight ratings (GVWR) of 10,000 lbs. or less are included in the program. In 1998, Connecticut substantially enhanced its existing I/M program to meet new SIP requirements as well as federal requirements for I/M improvements. The emission test was changed from an unloaded idle emission test to a loaded-mode test (ASM2525¹). With this change, Connecticut began evaluating emissions of oxides of nitrogen² (NO_x) along with HC and CO. A loaded-mode test uses a chassis dynamometer to simulate on-road driving. If the vehicle could not be safely tested on a dynamometer, it received a pre-conditioned two-speed idle (PCTSI) test. In addition, the inspection included a gas cap pressure test to check to see if the gas cap holds pressure. Leaking gas caps are a major source of evaporative HC emissions. The inspection continued to include a visual emission control component check.

1 The ASM2525 or Acceleration Simulation Mode test measures HC, CO and NO emissions while the vehicle is driven at a constant speed (25 MPH) on a treadmill-like device termed a dynamometer.

2 Nitric oxide (NO) is measured as a surrogate for oxides of nitrogen (NO_x). NO_x along with HC emissions are considered to be the major ozone pre-cursors.

In 2003, DMV again made substantial revisions to the program. The inspection network was changed from a centralized system with about 25 inspection stations to a decentralized system with a contractor equipped limit of 300 stations³. The goals of these changes were to improve customer convenience to the public by decreasing the waiting time for emissions testing, directly involve the repair industry with emissions testing and enhance opportunities for small business development. In addition, 1996 and newer models started receiving on-board diagnostic equipment (OBD) inspections⁴, instead of ASM2525 or PCTSI exhaust emissions tests. All 1996 and later model year light-duty vehicles sold in the United States contain the second generation of OBD, termed OBDII. OBDII systems can detect malfunctions or deterioration of emission control components, often well before the motorist becomes aware of any problem. Inspecting vehicles by reading the OBDII system codes can identify vehicles with serious emission control malfunctions more accurately and cost-effectively than traditional tailpipe tests, and help technicians diagnose and repair them. Diesel powered vehicles less than 10,000 lbs GVWR receive tests for excessive exhaust smoke, if they cannot receive OBDII tests.

Evaluating OBDII test results presents special challenges since tailpipe emission results are not available for each vehicle. The methodology for this evaluation has instead utilized data on different inspection components to determine if the appropriate number of vehicles are being failed and repaired. This approach is consistent with the purpose of OBDII system, since it assures that Connecticut is identifying and requiring the repair of vehicles that exceed design emission standards by more than 50%, as required by the EPA. As a further check on the integrity of the OBDII inspection, the analysis correlates emission readings from remote sensing devices with OBDII inspection results. This helps to determine if many high emitting vehicles are passing their OBDII inspection.

Evaluating decentralized inspections requires a comprehensive assessment of how well stations comply with mandated inspection procedures. Generally, there are greater opportunities for fraud in decentralized facilities, because there are more stations that need policing. Using data and procedures provided by the DMV, de la Torre Klausmeier Consulting, Inc. (dKC) assessed effectiveness and enforcement of Connecticut's program.

³ This number has dropped from 300 stations to 260 stations by the end of 2007.

⁴ 1997 and newer light-duty diesels (<8500 lbs GVWR) also get OBD inspections.

2.0 Observed Failure Rates for Gasoline Powered Vehicles

Failure rates for gasoline powered vehicles were calculated using test results from I/M test stations. Below is a brief description of the criteria used to determine if a vehicle passes or fails inspection.

Pass Fail Criteria

ASM2525 or Pre-Conditioned Two-Speed Idle (PCTSI) Inspection (pre-1996 vehicles): Vehicles fail if they exceed Connecticut's cutpoints (emissions standards). For the ASM2525 test, HC, CO and NOx emissions are evaluated. For the PCTSI test, HC and CO emissions are evaluated. A vehicle fails if it exceeds cutpoints that are recommended by EPA.

Gas Cap Test: Vehicles fail if their gas cap cannot hold pressure. Beginning in November 2004, only pre-1996 light-duty vehicles receive gas cap tests. The OBDII system adequately tests the gas cap on most 1996 and newer vehicles.

OBDII Inspection: 1996 and newer light-duty vehicles get an OBDII inspection. The emissions test system is plugged into the OBDII connector and information on the status of the vehicle's OBD system is downloaded. Vehicles fail the OBDII inspection if they have the following problems:

- Malfunction Indicator Lamp (MIL⁵) is commanded-on
- MIL not working (Termed Key-On Engine-Off, KOEO, failure⁶)
- OBD diagnostic link connector damaged

During this time period, vehicles that exceeded EPA's limits on the numbers of monitors that can be not ready were defaulted to the appropriate tailpipe test (ASM2525 or PCTSI). Vehicles that failed to communicate with Connecticut's test equipment also received tailpipe tests.

⁵ MIL is a term used for the light on the instrument panel, which notifies the vehicle operator of an emission related problem. The MIL is required to display the phrase "check engine" or "service engine soon" or the ISO engine symbol. The MIL is required to illuminate when a problem has been identified that could cause emissions to exceed a specific multiple of the standards the vehicle was certified to meet.

⁶ The Key-On Engine-Off (KOEO) determines if the MIL bulb is working. The bulb should illuminate when the vehicle is turned on but not started.

Summary of Fail Rates

Following is a summary of test results for the January 1, 2006 to December 31, 2007 period. During this period 1,786,563 gasoline powered vehicles received initial tests.

- Overall, 141,775 vehicles (7.9%) failed the initial inspection. The overall initial failure rate was around 8% in both 2006 and 2007.
 - 15.5% of the vehicles failed their first retest.
 - Vehicles can fail for more than one reason.
- 88,438 (7.1%) vehicles failed the OBD test. The initial OBD test failure rate was around 7% in both 2006 and 2007.
 - 6.2% of the vehicles failed the test because the MIL was commanded-on.
 - 11.0% of the vehicles failed the first OBD retest.
- 46,222 (9.9%) vehicles failed the ASM2525 test. The initial ASM2525 test failure rate was around 10% in both 2006 and 2007.
 - 23.3% of the vehicles failed the first ASM2525 retest.
- 7,114 (8.9%) vehicles failed the PCTSI test. The initial PCTSI test failure rate was around 9% in both 2006 and 2007.
 - 15.2% of the vehicles failed the first PCTSI retest.
- 20,578 (4.4%) 1982 to 1995 model vehicles failed the gas cap test. The initial gas cap test failure rate was around 4% in both 2006 and 2007.
 - 3.8% of the vehicles failed the first gas cap retest.

Conclusion: Failure rates in Connecticut's test-and-repair program are in line with failure rates reported in Test-Only programs, e.g., Delaware. Test-Only programs generally are considered by EPA to be the model for I/M performance.

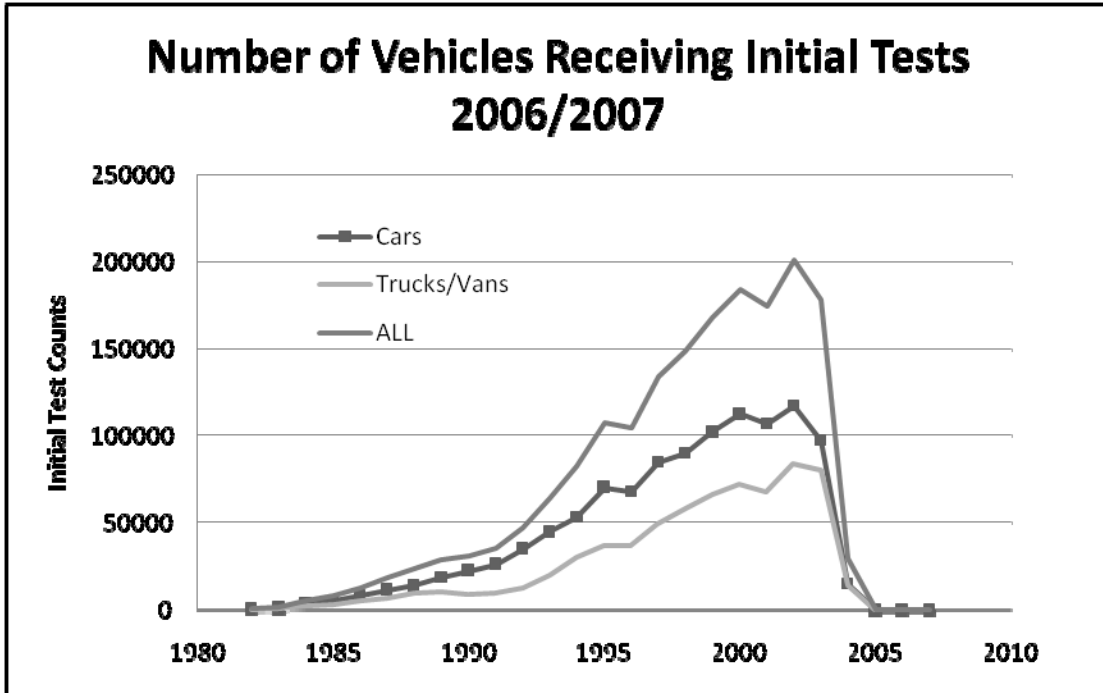

This chart shows the total number of inspections by model year and vehicle type. The first four model years are exempted from testing, so the number drops sharply after 2003.

Note: All vehicles are 10,000 lbs. or less GVWR.

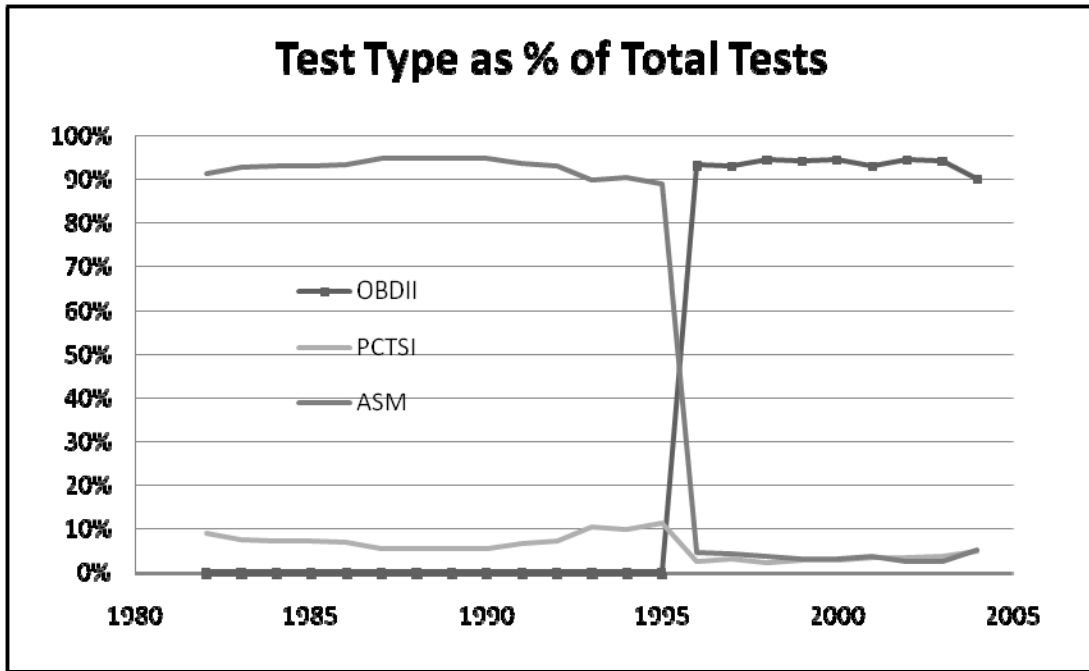

This chart shows the total number of inspections by model year and final inspection type. Most 1996+ vehicles received OBDII tests. Because of provisions to perform back-up tailpipe tests on vehicles that were not ready or failed to communicate with test system, some 1996+ vehicles received tailpipe tests. Also, a small percentage (2%) of the vehicles were heavy-duty models without OBD systems.

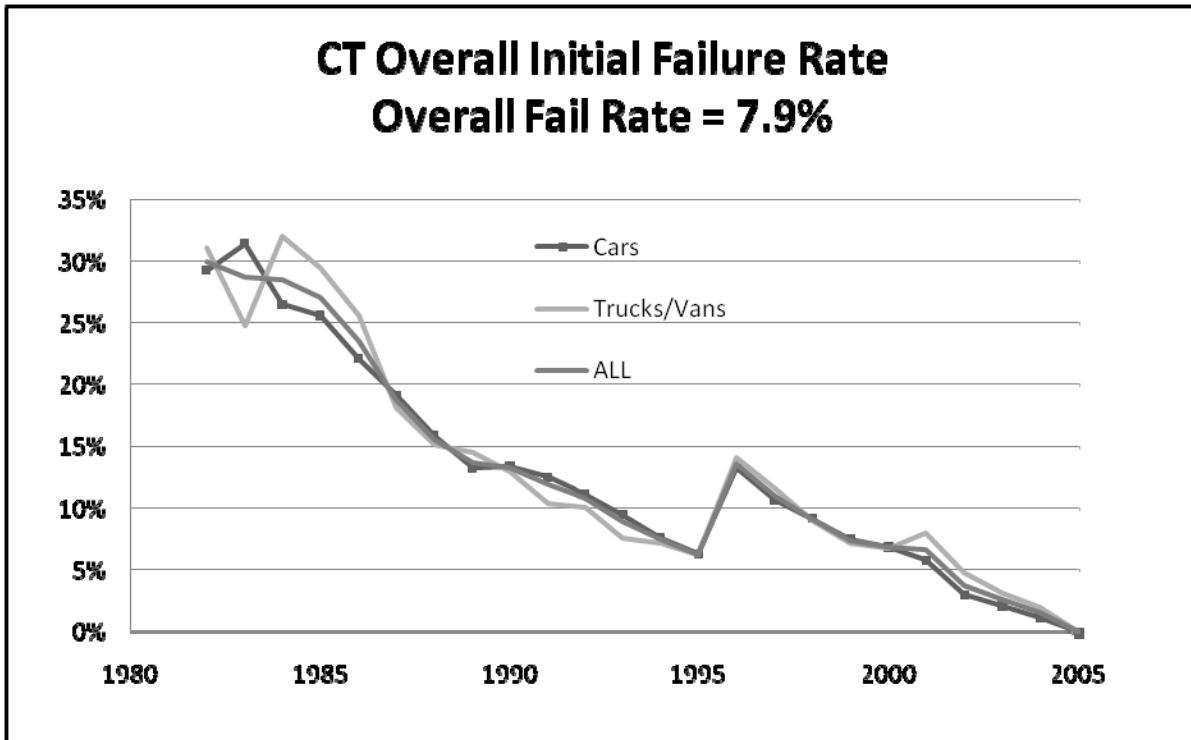

This chart shows the overall percent of vehicles that fail the tailpipe test, gas cap test, visual emission control component inspection, or the OBD test. Some vehicles fail more than one inspection component. As expected, the failure rate is lowest for new vehicles. The failure rate for cars and trucks spikes up for 1996 model year vehicles, due to implementation of the OBDII test. Compliance with the OBDII test is considered to be more difficult than compliance with the ASM2525 or PCTSI test. The failure rate is consistent with failure rates reported in test-only programs in other jurisdictions.

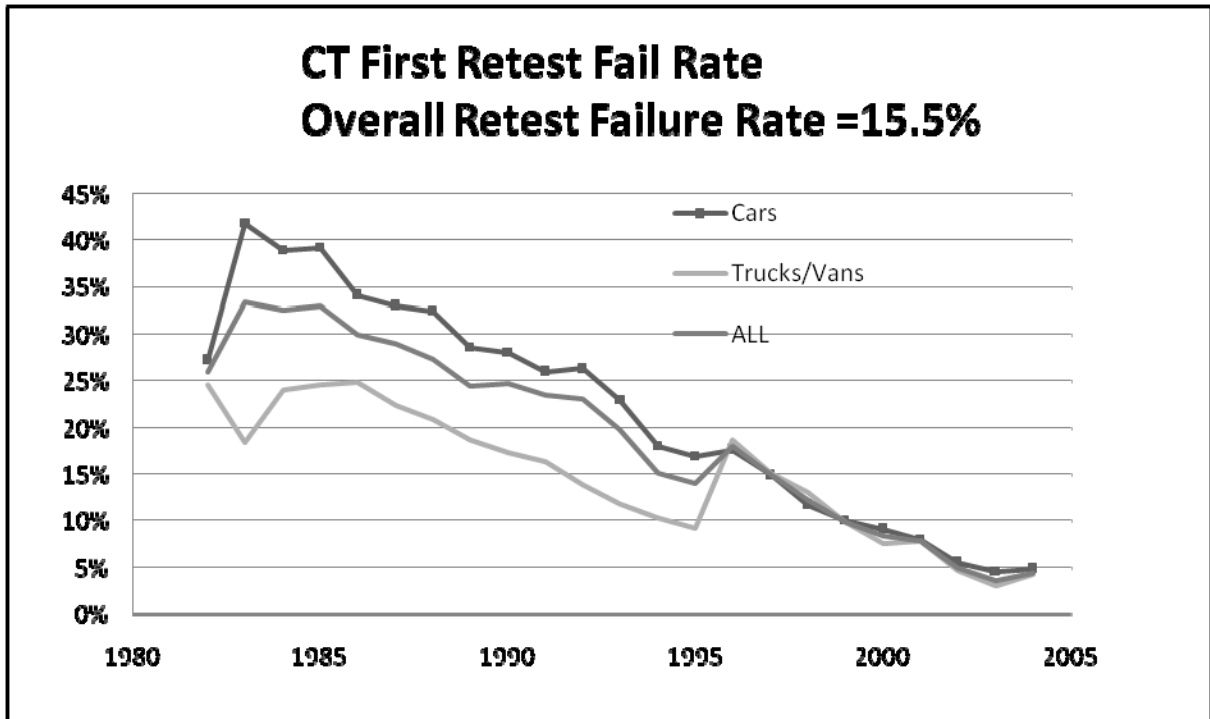

This chart shows the percent of vehicles by model year that fail their first retest. The failure rate is highest for the older vehicles, which is typical. Overall, 15.5% of the vehicles fail their first retest.

CT Initial ASM2525 Failure Rate Overall Rate = 9.9%

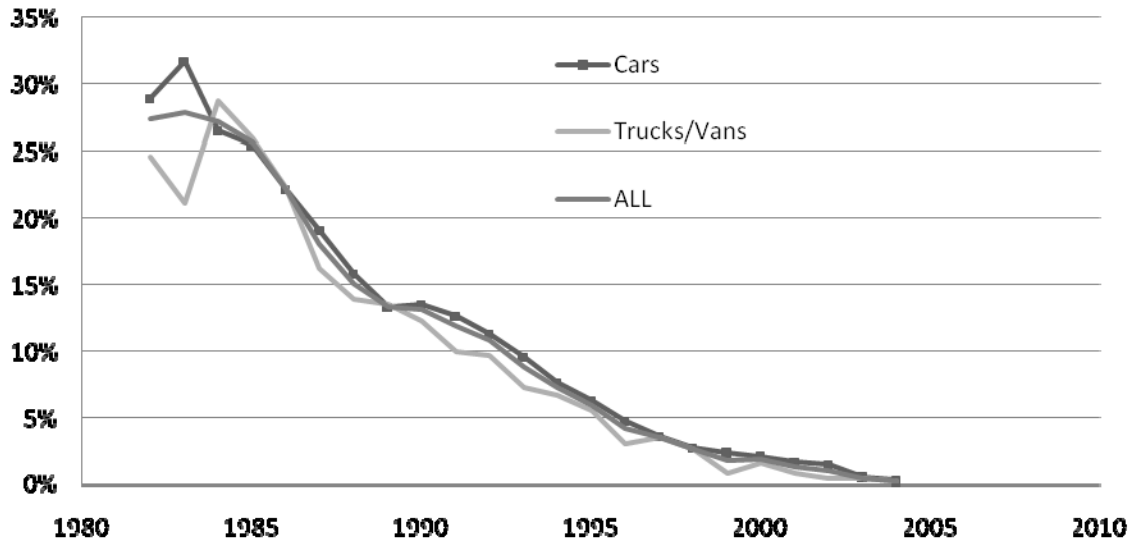

This chart shows failure rates by model year for the ASM2525 test. The average ASM2525 test failure rate for all vehicles was 9.9%. Typically, a higher failure rate for older model year vehicles is expected.

Note: 1996 and newer vehicles received ASM2525 or PCTSI tests only if they were not ready or could not communicate with Connecticut's OBDII test system.

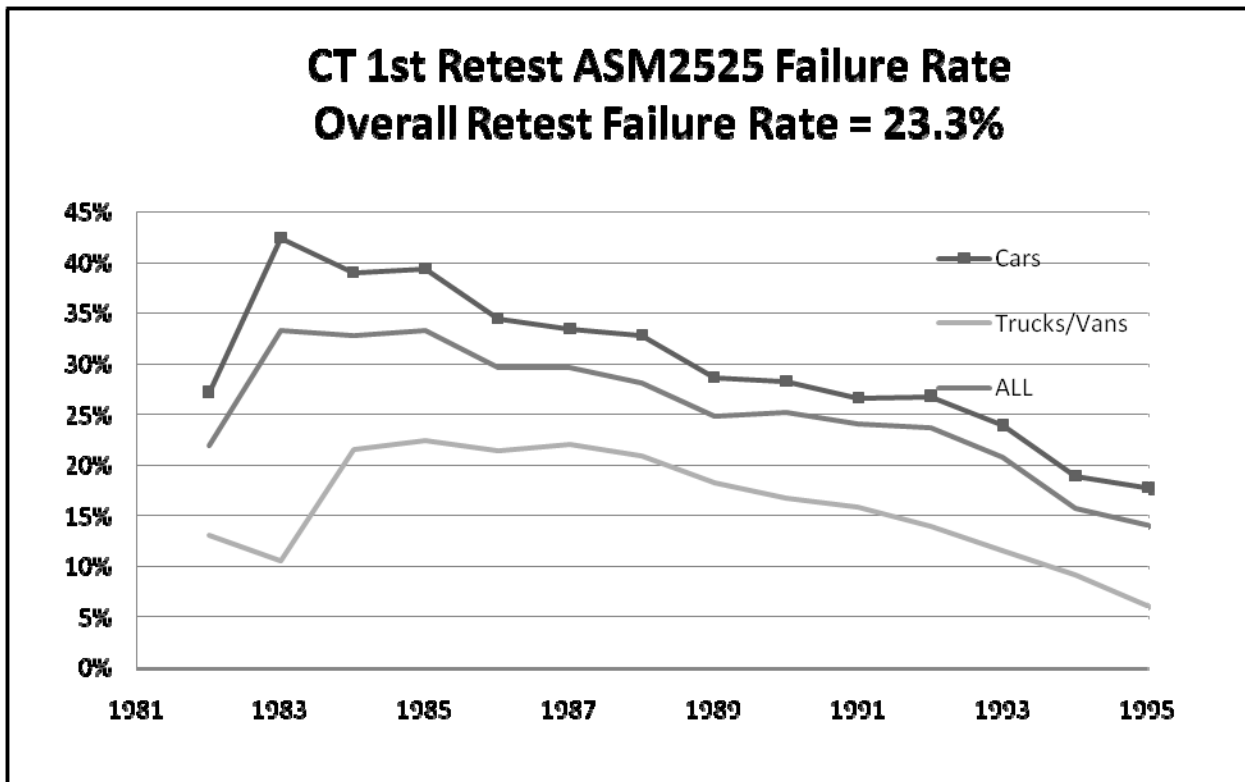

This chart shows the percent of vehicles by model year that fail their first ASM2525 retest. The retest failure rate generally is highest for the older vehicles. Overall, 23.3% of the vehicles fail the first ASM2525 retest. This percentage is lower than what was observed in the last biennial report, indicating that technicians might be performing better repairs. There were too few 1996+ vehicles receiving ASM2525 retests for a meaningful analysis.

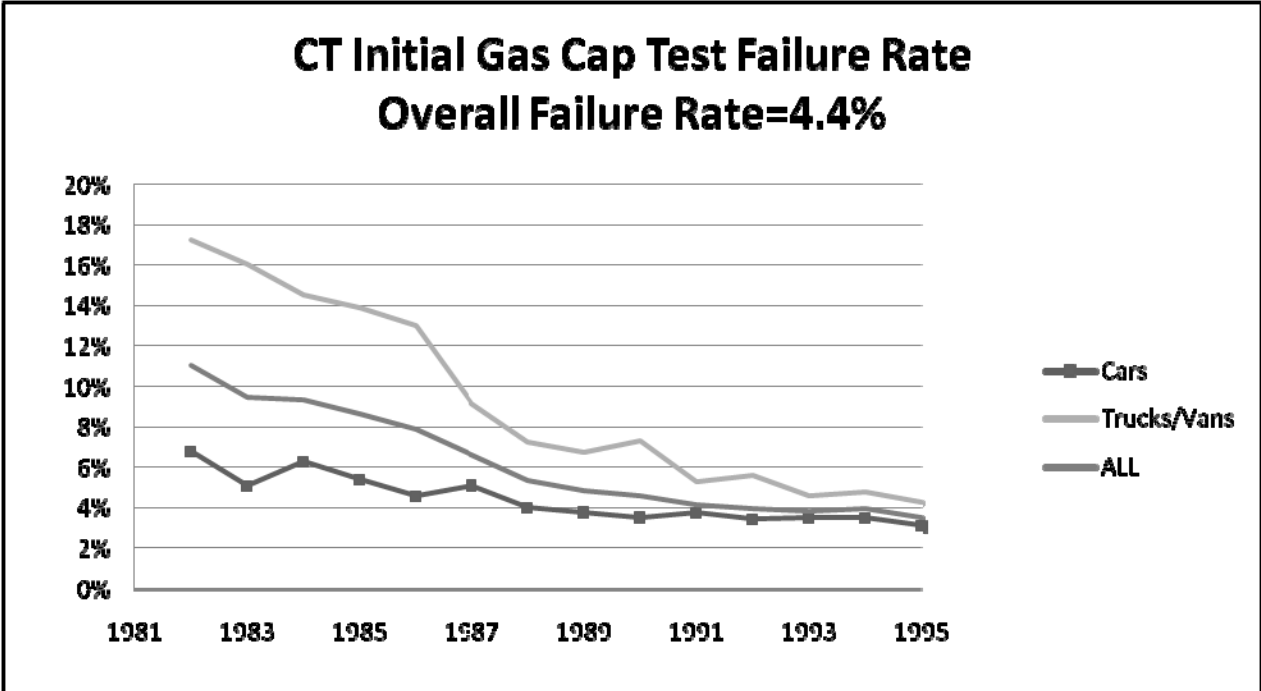

This chart shows the gas cap pressure test failure rate by model year. As with the ASM2525 test, the failure rate is higher for older vehicles, which is expected. Note that 1996 and newer light-duty vehicles no longer receive gas cap tests.

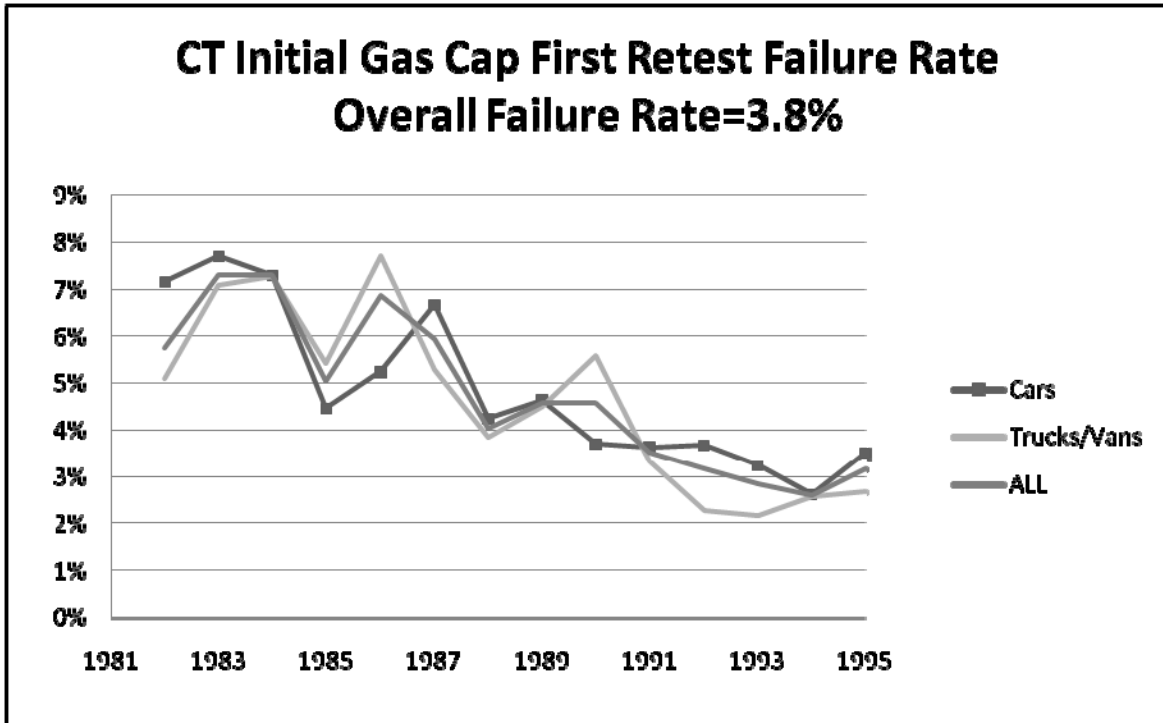

This chart shows the gas cap retest failure rate by model year. Overall, 4% of the vehicles fail the first gas cap retest.

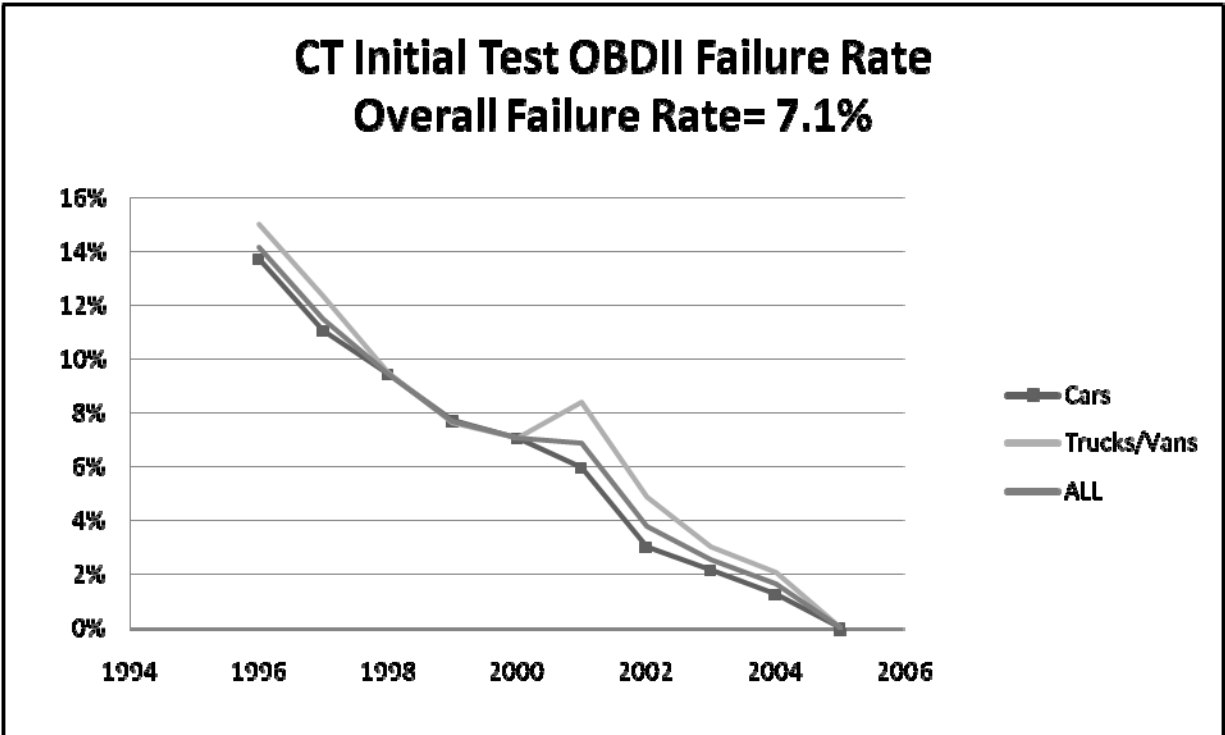

This chart shows failure rates by model year for the OBD test. The average OBD test failure rate for all vehicles was 7.1%. Typically, a higher failure rate for older model year vehicles is expected. 14% of the 1996 model year vehicles fail the test versus 2% of the 2004 models.

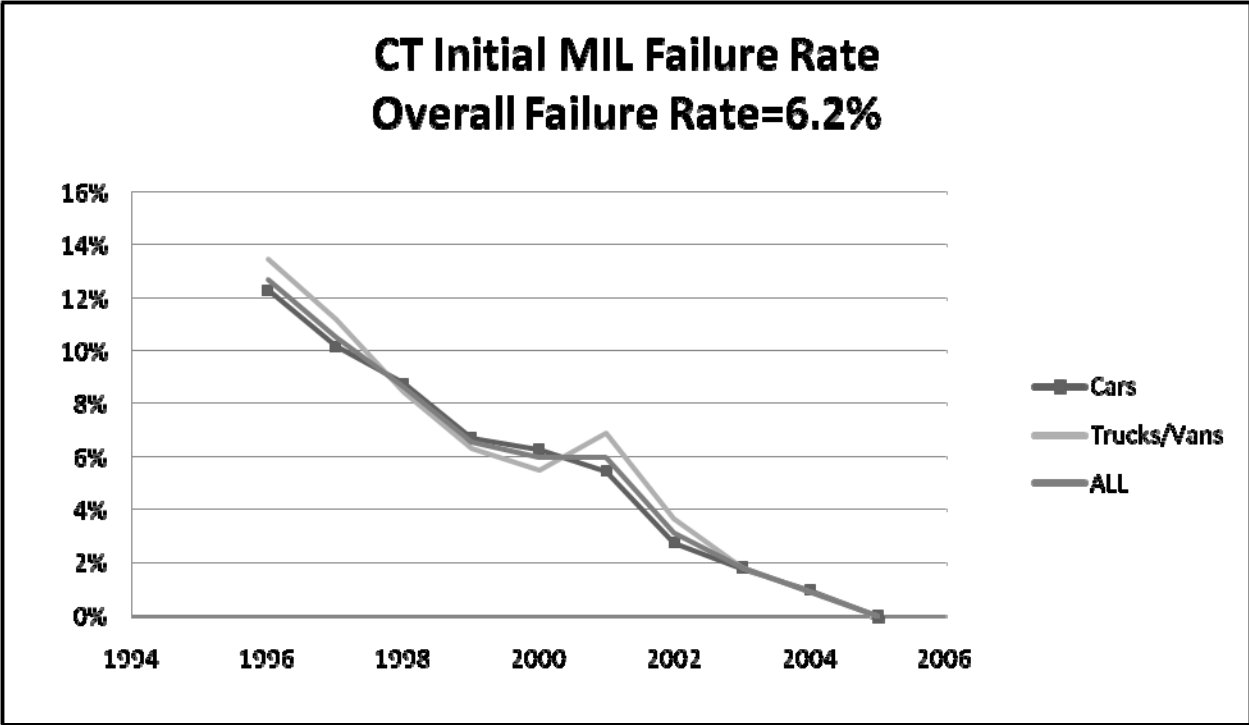

This chart shows the percentage of vehicles that fail the MIL Command check that's part of the OBD test. Most OBDII failures are for the MIL Command check. The average MIL failure rate for all vehicles was 6.2%. This graph shows that older vehicles have a higher failure rate, as expected.

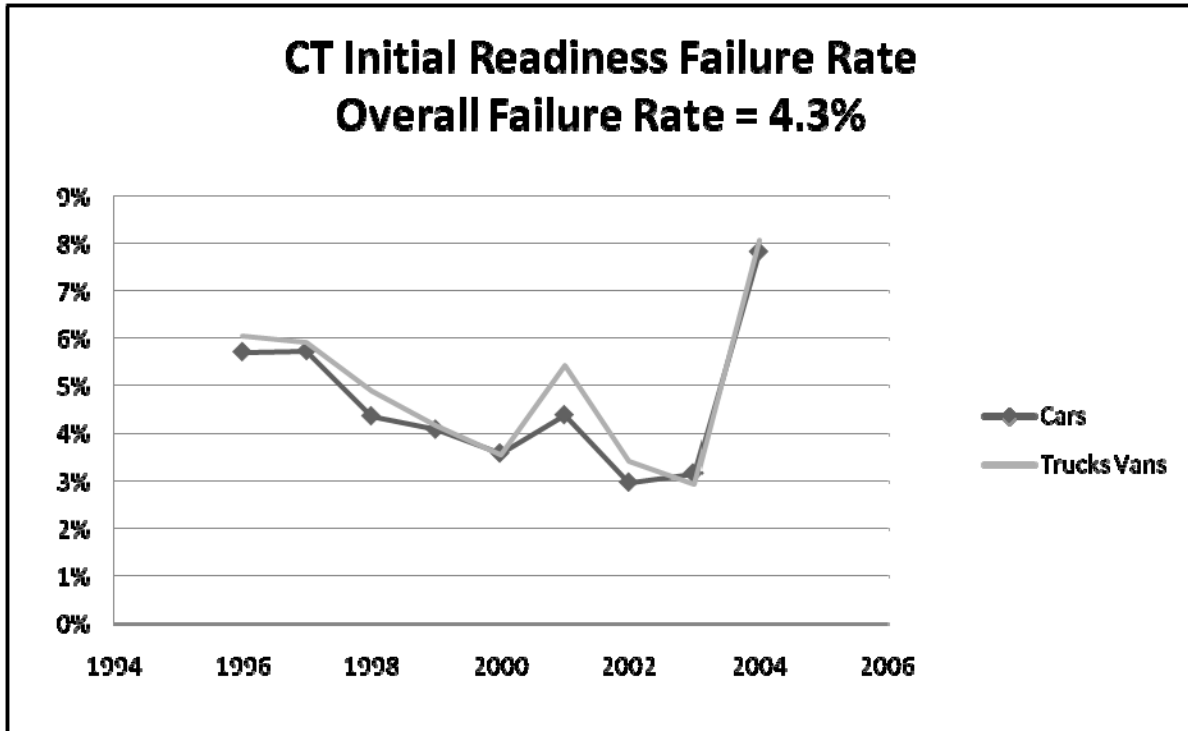

This chart shows the percentage of vehicles that exceed EPA’s readiness criteria. OBDII systems have up to 11 diagnostic monitors, which run periodic tests on specific systems and components to ensure that they are performing within their prescribed range. OBDII systems must indicate whether or not the onboard diagnostic system has monitored each component. Components that have been diagnosed are termed “ready”, meaning they were tested by the OBDII system. During the time period these data were collected, vehicles that were not ready receive tailpipe emissions tests, if they pass all other OBDII inspection criteria. Overall, 4.3% of the vehicles fail EPA’s readiness criteria. With the implementation of the next generation of software, not ready vehicles will fail.

The high not ready rate for 2004 models is due to the fact that over half of the 2004 vehicles tested had dealer plates. Vehicles owned by dealers typically have high not ready rates, because their batteries often are dead or had been disconnected during dealer prep⁷.

⁷ Readiness status for all monitors usually sets to not ready when a vehicle’s battery is disconnected.

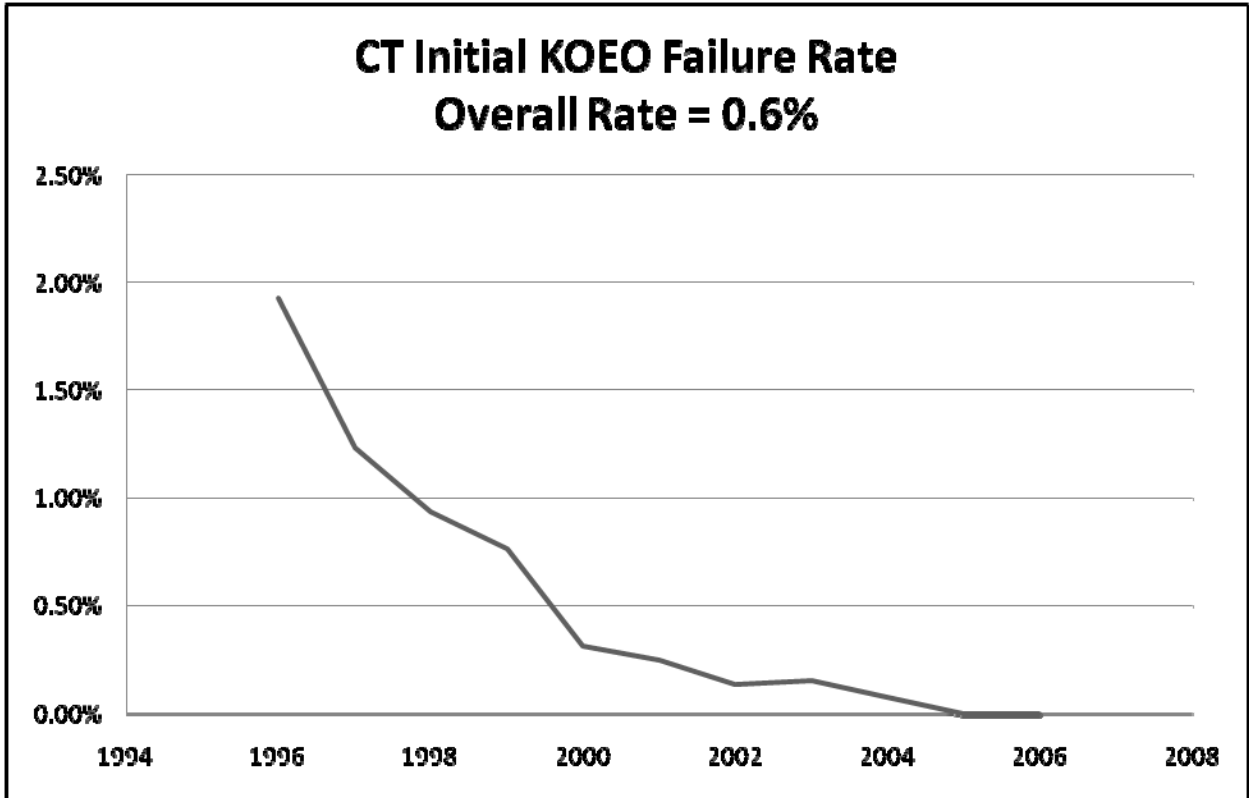

This chart shows failure rates by model year for the Key-On Engine Off (KOEO) test, which is part of the OBD test. The average KOEO failure rate for all vehicles was 0.6%. The KOEO determines if the MIL bulb is working. The bulb should illuminate when the vehicle is turned on but not started.

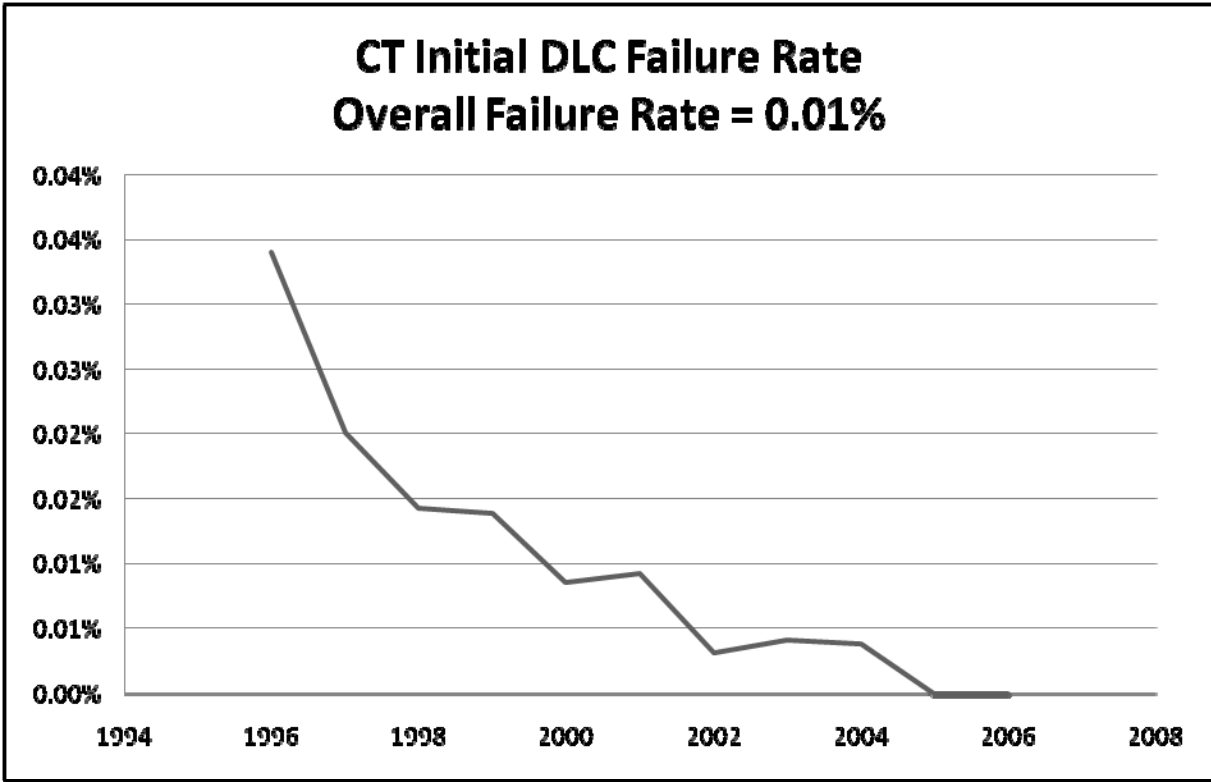

This chart shows the percentage of vehicles that fail because the OBDII connector, termed DLC, is missing, damaged or obstructed. Overall, 0.01% of the vehicles fail for this reason.

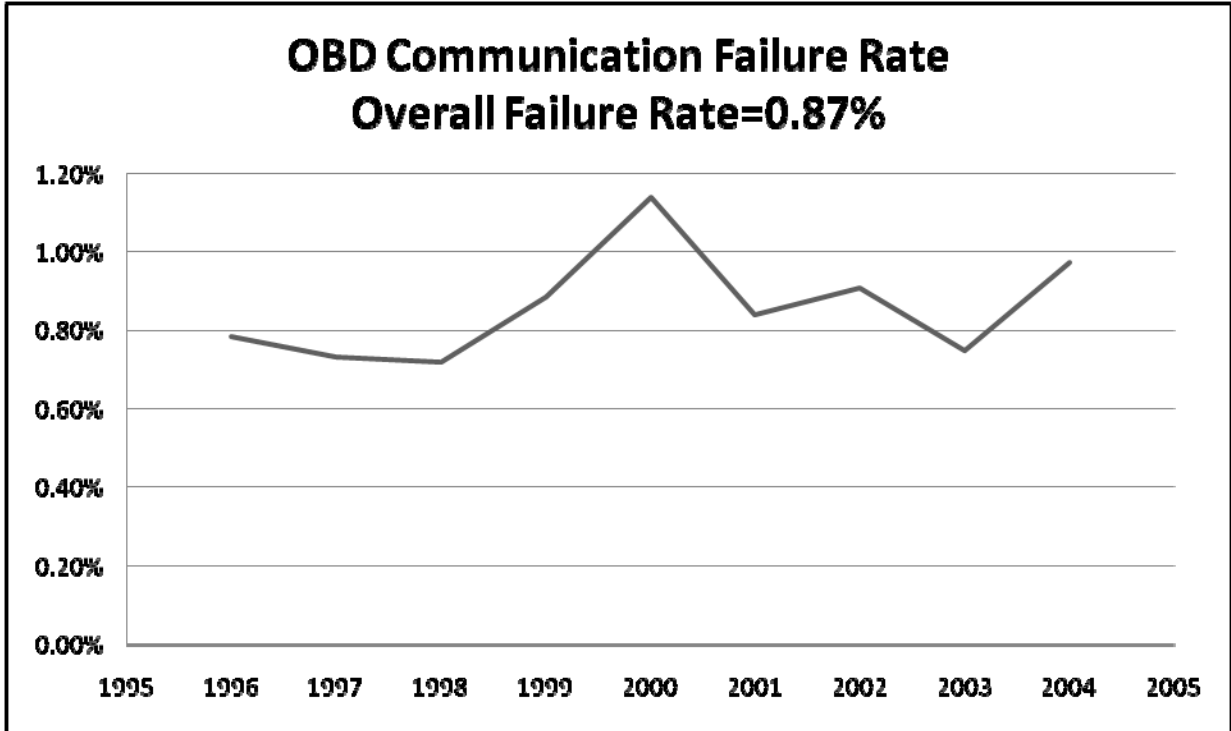

This chart shows the percentage of vehicles that fail to communicate with the OBDII test equipment. Overall, 0.9% of the vehicles fail for this reason. Vehicles that failed to communicate with the test equipment received tailpipe emissions tests, if they pass all other OBDII inspection criteria.

CT First Retest OBDII Failure Rate Overall Retest Failure Rate=11.0%

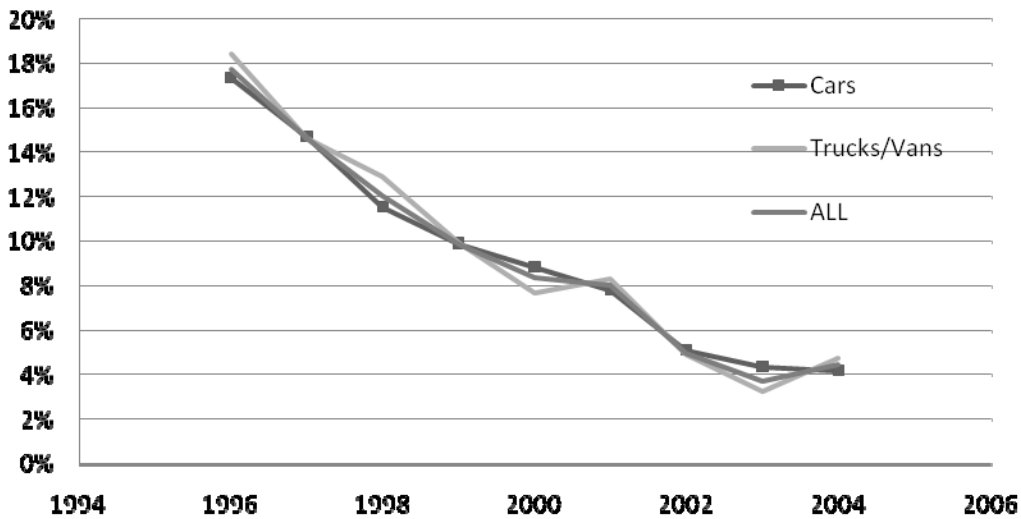

This chart shows failure rates by model year for the first OBD retest. The average failure rate for all vehicles in the first OBD retest was 11.0%. Note that Connecticut requires OBD failures to meet readiness requirements when retested. If a vehicle does not meet readiness requirements when retested, the inspection is aborted. Vehicles that are not ready on retest are not included in the above fail percentage.

3.0 Observed Failure Rates for Diesel Powered Vehicles

Diesel powered vehicles 10,000 lbs. or less GVWR also are tested in the I/M program in Connecticut. If the vehicle is equipped with an OBDII system, an OBDII test is performed. Otherwise the vehicle receives a test for excessive exhaust smoke opacity.

Failure rates for diesel powered vehicles were calculated using test results from I/M test stations. Below is a brief description of the criteria used to determine if a vehicle passes or fails inspection.

Pass Fail Criteria

Modified Snap Acceleration (MSA) Test: With this test, the throttle is snapped and exhaust smoke opacity is measured. Test is done in “neutral”. The average of three snaps is calculated and compared to the standard.

Loaded Mode Diesel (LMD) Test: Vehicles are tested using a dynamometer to simulate driving at 30 mph. Exhaust smoke opacity is measured.

OBDII Inspection: 1997 and newer diesels less than 8500 lbs GVWR get an OBDII inspection. The emissions test system is plugged into the OBDII connector and information on the status of the vehicle’s OBD system is downloaded. Diesel vehicles fail the OBDII inspection if they have the following problems:

- Malfunction Indicator Lamp (MIL) is commanded-on
- MIL not working (Termed Key-On Engine-Off, KOEO, failure)
- OBD diagnostic link connector damaged

Summary of Fail Rates of Diesel Powered Vehicles

Following is a summary of test results for the January 1, 2006 to December 31, 2007 period. During this period, 18,496 diesel powered vehicles received opacity tests and an additional 3,221 vehicles received OBD tests.

- 165 (5.0%) vehicles failed the Modified Snap Acceleration (MSA) test.
 - 30% of the vehicles failed the first MSA retest.
- 219 (1.4%) vehicles failed the Loaded Mode Diesel (LMD) test.
 - 33% of the vehicles failed the first LMD retest.
- 361 (11.2%) vehicles failed the OBD test.
 - 7.1% of the vehicles failed the first OBD retest.

Conclusion: Outside of Connecticut, few states perform periodic tests on diesel powered vehicles, so there's little basis for a comparison of Connecticut's diesel fail rates with other States.

4.0 Enforcement of Connecticut's I/M Program

Connecticut's program uses both registration denial and late fee assessment to enforce emission testing compliance. This section presents an analysis of data relevant to the enforcement of Connecticut's I/M program. Statistics required by 40 CFR 51.366 are presented below and in the Appendix B, with exception of 51.366(d)(1)(iv) and (v) which are not applicable to Connecticut's program.

Overall Compliance Rate

Following is the percentage of motorist compliance based upon a comparison of the number of valid final passing tests with the number of subject vehicles:

- 2006: 96.0%
- 2007: 96.7%

Connecticut I/M SIP assumes that 96% of the vehicles subject to I/M requirements actually comply.

Late Fees

- In 2006, 34,439 late fees were assessed.
- In 2007, 84,217 late fees were assessed.

The increase in assessed late fees from 2006 to 2007 appears to be associated with the following:

- The lower number of late fees in 2006 were mostly the result of lower initial test volume and the policy of not assessing late fees on any vehicles that had first cycle due dates. This was due to the effect of the suspension period and the subsequent adjustment in due dates for those affected vehicles.
- The higher 2007 late fees were also the result of a higher volume of testing and registration denial displaying its full impact due to the completion of a full two year renewal cycle.

Registration Audits

In 2006, 898,068 registration renewals were checked, resulting in 38,759 denials of which 34,290 (88%) later complied. In 2007, 889,965 registration renewals were audited, resulting in 37,078 denials of which 34,278 (92.4%) later complied.

Preventing Circumvention of Connecticut's I/M Requirement

EPA requires states to prevent motorists from avoiding I/M requirements by falsely registering vehicles out of the program area or falsely changing fuel type or weight class on the vehicle registration. EPA also requires states to report on results of special studies to investigate the frequency of such activity.

- **Circumventing I/M Tests in Connecticut** – Connecticut tests all fuel types, including hybrids, so motorists cannot avoid inspection by changing fuel type. It may be possible to avoid inspection by registering the vehicle with a GVWR greater than 10,000 lbs. The majority of vehicles registered with an incorrect GVWR are those where the vehicle owner registers the vehicle at a lower weight to avoid the added expense and would not be emission eligible (>10,000 lbs.) with their corrected weight.
- **Detection and Enforcement Against Motorists That Falsely Change Vehicle Classifications To Circumvent Program Requirements** – 97.7% of emission eligible vehicles in Connecticut are in the Passenger, Commercial or Combination classifications. Because of the added expense, documentation and inspection requirements needed to change a vehicle's registration classification to a non-emission eligible class, incidents of such modifications are rare.

Percent of Failed Vehicles That Ultimately Pass

To determine whether vehicles that fail ultimately pass the test, the fate of vehicles failing the I/M test in 2007 period was evaluated. Failures for the first three months of 2007 were tracked through 12/31/07. Results are shown in the table and figure below.

Overall, 29% of the failures during this three month period had not yet received a passing result or waiver. Ultimately, these vehicles must comply or they cannot be registered in Connecticut, since DMV now makes I/M compliance a prerequisite for vehicle registration. Over 99% of the vehicles tested from 1/1/06 to 12/31/07 complied with I/M program requirements and are registered.

DMV investigated vehicles that had yet to pass based on this analysis to determine their ultimate disposition. Below are the results of this investigation:

- 75% had registrations due in 2008 or 2009.
- 8% had no record of vehicle in DMV database.
- 17% of the initial failures could not be accounted for.

The fact that most of these vehicles were due for registration in 2008 and 2009, might explain why they had yet to pass their emissions test. Overall, a small percentage (<1%) of the tested vehicles fail to comply with I/M standards. A multistate database must be provided by EPA before a more comprehensive evaluation can be conducted.

**Vehicles Tested from 1/1/07 to 3/31/07
with No Known Outcome**

Model Year	Initial Fail	Final Retest Pass	No Retest Pass	% No Final Pass
1983	35	22	13	37%
1984	208	134	74	36%
1985	266	186	80	30%
1986	360	247	113	31%
1987	435	307	128	29%
1988	495	340	155	31%
1989	525	397	128	24%
1990	562	410	152	27%
1991	575	403	172	30%
1992	717	532	185	26%
1993	785	604	181	23%
1994	933	734	199	21%
1995	1,081	875	206	19%
1996	2,046	1,255	791	39%
1997	2,416	1,593	823	34%
1998	1,931	1,286	645	33%
1999	2,136	1,593	543	25%
2000	1,747	1,253	494	28%
2001	833	525	308	37%
2002	665	479	186	28%
2003	834	674	160	19%
2004	100	87	13	13%
TOTAL	19,685	13,936	5,749	29%

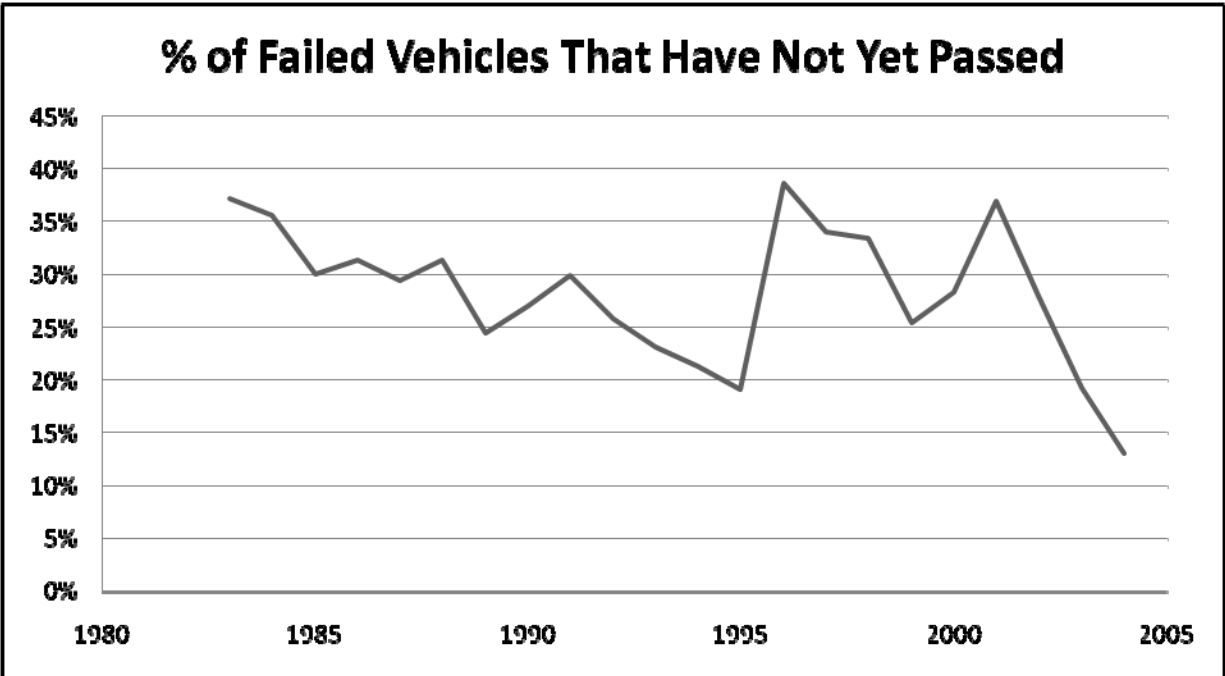

This chart shows the percentage of vehicles that fail the emission test in the first three months of 2007 that never ultimately passed in 2007. The increase from 1995 to 1996 indicates that compliance with the OBD test may be more difficult than the tailpipe test used for pre-1996 vehicles. Most of these vehicles were due for registration in 2008 and 2009, which might explain why they had yet to pass their emissions test.

Waivers Issued

Another issue related to enforcement is the number of waivers issued. Program effectiveness is inversely proportional to the waiver rate. As the following table shows, less than 0.6% of the failed vehicles receive waivers, indicating that the program is effective. This is much lower than the waiver rates in many other programs. Connecticut’s I/M SIP assumes a waiver rate of 1%.

% of Failed Vehicles Receiving Waivers in 2006 and 2007

Model Year	Passenger car (P)	Truck (T)	Total # of Waivers	# of Failed Vehicles	% of Failed Vehicles Receiving Waivers
1982	3	0	3	261	1.15%
1983	8	0	8	522	1.53%
1984	19	2	21	1566	1.34%
1985	37	2	39	2184	1.79%
1986	27	2	29	2982	0.97%
1987	22	3	25	3384	0.74%
1988	26	7	33	3665	0.90%
1989	17	5	22	3913	0.56%
1990	28	2	30	4095	0.73%
1991	24	2	26	4213	0.62%
1992	18	1	19	5101	0.37%
1993	11	0	11	5700	0.19%
1994	16	3	19	6151	0.31%
1995	13	0	13	6713	0.19%
1996	90	37	127	14137	0.90%
1997	70	25	95	14716	0.65%
1998	68	30	98	13471	0.73%
1999	60	13	73	12346	0.59%
2000	49	5	54	12573	0.43%
2001	48	9	57	11604	0.49%
2002	7	0	7	7496	0.09%
2003	3	1	4	4519	0.09%
2004	0	0	0	459	0.00%
TOTAL	664	149	813	141771	0.57%

Conclusions regarding motorist compliance enforcement: Connecticut exceeds SIP requirements for enforcement of motorist compliance. The overall compliance rate in Connecticut exceeds 96%, which is the compliance rate assumed in Connecticut's SIP. Connecticut actively investigates non-compliance and assesses a large number of fines for late registrations. Connecticut issues fewer waivers than assumed in the I/M SIP.

Enforcement of Proper Test Procedures Through Trigger Reports and Video Audits

- DMV runs extensive trigger reports to assure that inspection stations follow proper test procedures. DMV has developed a comprehensive set of triggers to verify and enforce compliance with proper test procedures.
 - Trigger reports look for anomalies in data recorded during inspection. They help DMV identify stations performing fraudulent or inaccurate inspections.
 - Triggers focus on finding the following types of fraud:
 - Clean Scanning: Performing an OBDII test on a fault-free vehicle instead of the vehicle that should be tested.
 - Clean Piping: Performing a tailpipe test on a passing vehicle instead of the vehicle that should be tested.
 - These reports are generated frequently to identify stations performing improper inspections. Connecticut promptly investigates all significant cases of possible inspection fraud.
- DMV employs four full-time video auditors who are constantly monitoring inspections during station operating hours via digital web cameras. Video audits have the following features:
 - Real time monitoring/control of vehicle inspections
 - Video auditors can selectively view inspections
 - If anomalies are detected – inspection can be halted
- No other state does more thorough trigger or video audits and follow-up actions.

Triggers for Clean Scanning/Clean Piping

DMV runs several trigger reports to identify clean scanning and clean piping:

- **Mismatch between entered VIN and OBDII VIN** – Inspectors may be attempting to pass vehicles with OBDII faults by scanning problem free vehicles instead of vehicles that should be inspected.
 - If the vehicle has an electronic VIN available through the vehicle's OBDII system, clean scanning cases can be identified by comparing entered VIN with VIN provided by vehicle's OBDII system.
 - In 2007, there were 320 incidences of OBD VIN mismatches out of 135,000 tests with OBD VINs (0.24%). Most mismatches were vehicles owned by the same person.
- **Questionable Retests** – Mismatches between initial tests and retests could indicate that the inspector clean-scanned vehicles on retests. DMV checks the following parameters:
 - Supported readiness monitors – different vehicles have different monitors
 - OBD computer identifiers
 - In 2007, out of about 53,000 OBD failures, 46 tests (0.09%) have been flagged by this trigger.

Triggers Continued:

- **Short Time Between Initial OBD Test Fail And Retest Pass** – Stations that often show short time periods between initial test failures and retest passes could be performing fraudulent inspections. (Short = ½ hour)
 - It is difficult to repair OBD failures and get failing vehicles to pass in a short time period:
 - MIL-On Fails – It takes time for the MIL to go off or readiness monitors to reset if codes are cleared.
 - Readiness Fails – It takes time for readiness monitors to set to ready, especially the evaporative monitor.
 - In 2007, out of about 53,000 OBD failures, only 19 tests (0.04%) have been flagged by this trigger.

- **Large Emission Reductions In A Short Time Period (1981-1995 Vehicles)** – Stations reporting large emission reductions in a short time period are more likely to be clean piping the retests. (Short = ½ hour)
 - In 2007, out of about 23,000 ASM2525 failures, 64 tests (0.3%) have been flagged by this trigger.

Summaries of Clean Scanning/Clean Piping Triggers

- DMV tabulates potential clean scanning and clean piping triggers by station.
- Stations with more than one minor trigger or any major trigger, e.g. large emission reductions in a short time period, are immediately investigated.
- Overall, less than 0.3% of the inspections were flagged by trigger reports, which indicates that inspection fraud is not a serious problem in Connecticut.

Example Report – Stations with the Most Trigger Hits

Station	<1hr OBD pass	<1hr>50%	Looser ASM2525 Cutpoints	OBD Parameter Mismatch	OBD VIN Mismatch	Total
A		1		12		13
B		1		9		10
C		3	1	1	3	8
D	1	1	1	4		7
E	1		1		3	5
F		2		1	2	5
G		2	1		2	5
H			1	1	3	5
I				1	3	4
J	1	2	1			4
K		1	1		2	4
L			1	1	2	4
M			4			4

Other Triggers:

DMV is investigating new triggers, including the following:

- Stations with lower than expected fail rates.
- Stations with higher than expected fail rates.

DMV is developing a new trigger report to identify stations with too high or too low failure rates. Too low or too high failure rates may indicate possible fraudulent activities or equipment problems. To account for differences in the age and type of vehicle being inspected, failure rates will be normalized for the age distribution of the vehicles inspected.

Calculation Procedure

Normalized failure rates will be calculated as follows:

1. Compute overall initial test failure rate of all stations by model year.
2. Tabulate percentage breakdown of initial tests by station by model year.
3. Calculate normalized failure rate by station by weighting the overall failure rate by the percentage breakdown for each station by model year. For example, if for a particular station, 50% of the initial tests were on 1997 vehicles and 50% of the initial tests were on 1998 vehicles, then the normalized failure rate for that station equals 50% times the overall failure rate of all stations for 1997 vehicles plus 50% times the overall failure rate for 1998 vehicles.
4. Compute the differences by station between the actual failure rate and the normalized failure rate.

After normalization, DMV then will identified outliers, i.e. stations with the largest positive percent differences (they fail too many vehicles) and stations with the largest negative percent differences (they fail too few vehicles).

Results for 2007

The following tables show stations with too low or too high failure rates based on normalized failure rates for 2007. This table also correlates normalized fail rate ranking with ranking based on trigger reports (1=most trigger hits). Note that stations with the lowest or highest fail rates do not appear to have more trigger hits. DMV is evaluating the vehicle mix and outliers statistically.

Station Rankings Based on Normalized Failure Rates – Stations with Lower Than Expected Failure Rates

Station ID	Actual Fail Rate	% of Normalized by Year	Rank	Rank According to Current Triggers
ST0000520	3.05%	40.21%	1	172
ST0000060	2.35%	41.07%	2	235
ST0004080	2.71%	42.93%	3	140
ST0004397	3.25%	46.52%	4	13
ST0000136	3.93%	47.37%	5	141
ST0000711	3.92%	47.64%	6	217
ST0000132	3.32%	48.70%	7	173
ST0002427	3.64%	51.03%	8	27
ST0000065	3.47%	52.81%	9	236
ST0000229	3.33%	54.59%	10	207

Station Rankings Based on Normalized Failure Rates – Stations with Higher Than Expected Failure Rates

Station ID	Actual Fail Rate	% of Normalized by Year	Rank	Rank According to Current Triggers
ST0004105	12.81%	157.70%	244	86
ST0004855	13.93%	158.51%	245	71
ST0002955	13.69%	160.48%	246	171
ST0004788	12.74%	160.98%	247	105
ST0001363	13.29%	161.30%	248	170
ST0003449	13.29%	164.19%	249	5
ST0004866	13.48%	164.70%	250	72
ST0001401	14.65%	167.21%	251	206
ST0001297	16.35%	180.03%	252	139
ST0003225	18.38%	214.73%	253	51

Evaluation of the data demonstrates that Connecticut vigorously enforces proper inspection procedures. Inspection fraud is not a problem in Connecticut’s I/M program. Connecticut actively investigates possible cases of inspection fraud and initiates corrective action. Less than 0.3% of the tests in Connecticut are suspect. DMV continues to evaluate new trigger reports.

5.0 Quality Assurance Audits

The State and its contractor, Applus, perform all the Quality Assurance (QA) audits required by EPA. Following is an overview of Connecticut's audits and other State QA activities.

Overt Audits

DMV meets EPA's Overt Audit requirements through the Emission Test Monitoring Report (ETMR). Connecticut prepares ETMRs more frequently than required by EPA. Each month, at least two ETMRs are prepared on each station. In addition, Applus also performs overt audits. Connecticut also checks far more items than required by EPA. Connecticut conducted 3,200 audits in both 2006 and 2007, on approximately 270 and 260 stations, respectively. The number of stations that have reached operational capacity varies during the year so Appendix B indicates a higher number of stations. Both OBD and tailpipe audits occurred. Results of an overt audit will not shut down a station.

Equipment Audits

DMV meets EPA's Equipment Audit requirements through the QA Audits. Connecticut conducts equipment audits much more frequently than required by EPA. High volume stations are checked monthly, while low volume stations are checked twice per year. In addition, Applus also performs equipment audits. Connecticut checks more equipment items than required by EPA. While an audit may require a station to discontinue tailpipe testing, it can continue OBD testing. Therefore, no stations were totally shut down due to a failed gas equipment audit. Results are presented below. In 2007 DMV focused on an evaluation of calibration data for auditing prioritizations. Although the number of audits decreased in 2007 from 2006, more stations failed audits.

Results of Equipment Audits

Parameter	2006	2007
Total Equipment Audits	1140	732
Total Equipment Audit Fails	275	282
Number of stations that failed an equipment (gas) audit ⁸	178	181
Percentage of stations that failed an equipment (gas) audit ⁹	58.90%	62.40%
Number of stations totally shut down as a result of a failed equipment (gas) audit ⁹	0	0
Percentage of stations shut down as a result of failed equipment (gas) audit ⁹	0.0%	0.0%

Covert Audits

DMV meets EPA's requirement for covert audits through its covert audit team. Connecticut exceeds EPA requirements for covert audit frequency. In 2006 and 2007, Connecticut conducted over 2,600 audits on the inspection stations. The increase in number of failures is due in part to Connecticut's investigating ways to improve the effectiveness of covert audits by using a wider variety of failure reasons and changes in the enforcement parameters. Warnings are routinely issued for false passes and suspensions are associated with violations found from trigger reports and data audits. The statutory and regulatory basis of the program does not allow Connecticut to issue fines or hold hearings to inspectors that falsely pass vehicles in covert audits. Instead, these inspectors are suspended from testing. Whether or not to suspend a station depends on DMV's assessment of the severity of the infraction.

Results of Covert Audits

Parameter	2006	2007
# Stations Receiving Covert Audit	270	262
The number of Covert audits:	1209	1203
Conducted with the vehicle set to Fail	863	1012
Resulting in a false Pass	196	300
Total number of Covert vehicles available for undercover audits over the year	9	8
Total number of Covert auditors available for undercover audits over the year	17	17
Inspectors suspended as a result of covert audits	27	4
Inspectors suspended for other causes	8	36

⁸ Failures are limited to gas calibration audits. By contract, testing contractor (Applus) must resolve equipment failures within 24 hours.

⁹ Stations are prohibited from performing tailpipe emission testing only until the equipment problem is resolved. Stations continue to perform OBD testing.

Contractor QA Activities

Fraud Prevention Systems

- Secure IRIS recognition system – use of biometrics
- Trend analysis monitoring –
 - Test time duration
 - Initial and retest pass/fail rate
 - Repair costs
 - Waivers
 - Speed variability check
 - Gas cap failure analysis
 - After hours inspection analysis
 - Aborted inspection analysis

Analyzer QA Functions

- Sample system leak check
- Analyzer gas calibrations – Every 72 hours or system will lock out testing
- CDAS units require a two point calibration with BAR 97 High gas followed by BAR 97 Low gas blend
- CDAS units have passed BAR 97 certification tests
- Dynamometer undergo a coast down every 72 hours
- Raw transport time verification
- Various other hardware checks are done every 72 hours
- Low sample flow, Sample dilution checks etc.

Contractor QA Activities (cont.)

Inspection Results Analysis Audits – monitoring of performance indicators

- # of offline inspections
- Gas cap failures
- OBD failures
- After hours testing

Digital Audits – monitoring of equipment service and repair

- Leak check failures
- NO cell age
- Gas cap calibration failure
- NO response time
- CO response time
- O2 response time
- NO low calibration gas drift
- Bench low calibration failure rate
- Parasitic loss changes

Conclusion: Connecticut exceeds EPA's recommended levels of QA. The program performs accurate inspections.

6.0 Analysis of Data from Remote Sensing Devices (RSD)

EPA requires that 0.5% of the tested vehicle population receive independent on-road emissions tests. Connecticut meets this requirement by using remote sensing devices (RSD). DMV requires Applus, to perform on-road tests with RSD. RSD offers the opportunity to obtain vehicle emissions measurements in a relatively non intrusive manner.

RSD measures emissions by passing a light source across a highway to a source detector. The source detector measures absolute concentrations of hydrocarbons (HC), carbon monoxide (CO), nitric oxide¹⁰ (NO), and carbon dioxide (CO₂) in the diluted exhaust. From these measurements, exhaust concentrations of HC, CO, and NO in the undiluted exhaust are calculated.

In August 2007, Applus contracted ESP¹¹ to conduct approximately 20,000 tests using RSD. After removing invalid records and matching results with the vehicle I/M database, 10,560 records remained (~1% of the vehicles tested in the I/M program annually). The primary reason for removing records is that the four newest model years are not in the I/M database, since they are exempt from testing. The RSD program meets EPA's on-road test requirements.

¹⁰ NO is used as a surrogate for oxides of nitrogen (NO_x).

¹¹ ESP is the only provider of Remote Sensing services.

Observed Remote Sensing Device (RSD) Emission Levels

- As expected, average RSD emissions and the percentages of high emitters are lowest for the newest vehicles.
- 0.21% of the vehicles scanned exceeded the 6% RSD CO limit. This criteria is used in some programs to identify high emitting vehicles. In 2005, when the last survey was done, 0.29% of the vehicles tested exceeded the 6% RSD CO limit.
- Emission trends can be observed before and after the emissions inspection. Of particular interest are RSD emissions for vehicles that were scanned via RSD prior to failing I/M tests or after failing.
- Average RSD emission levels for vehicles that failed I/M tests were much greater than average RSD emission levels for vehicles that had passed.
 - In particular, OBDII failures had much higher emissions than vehicles that passed their OBDII inspection.

Conclusion: OBDII tests identify vehicles with high emissions even though they do not directly measure emissions.

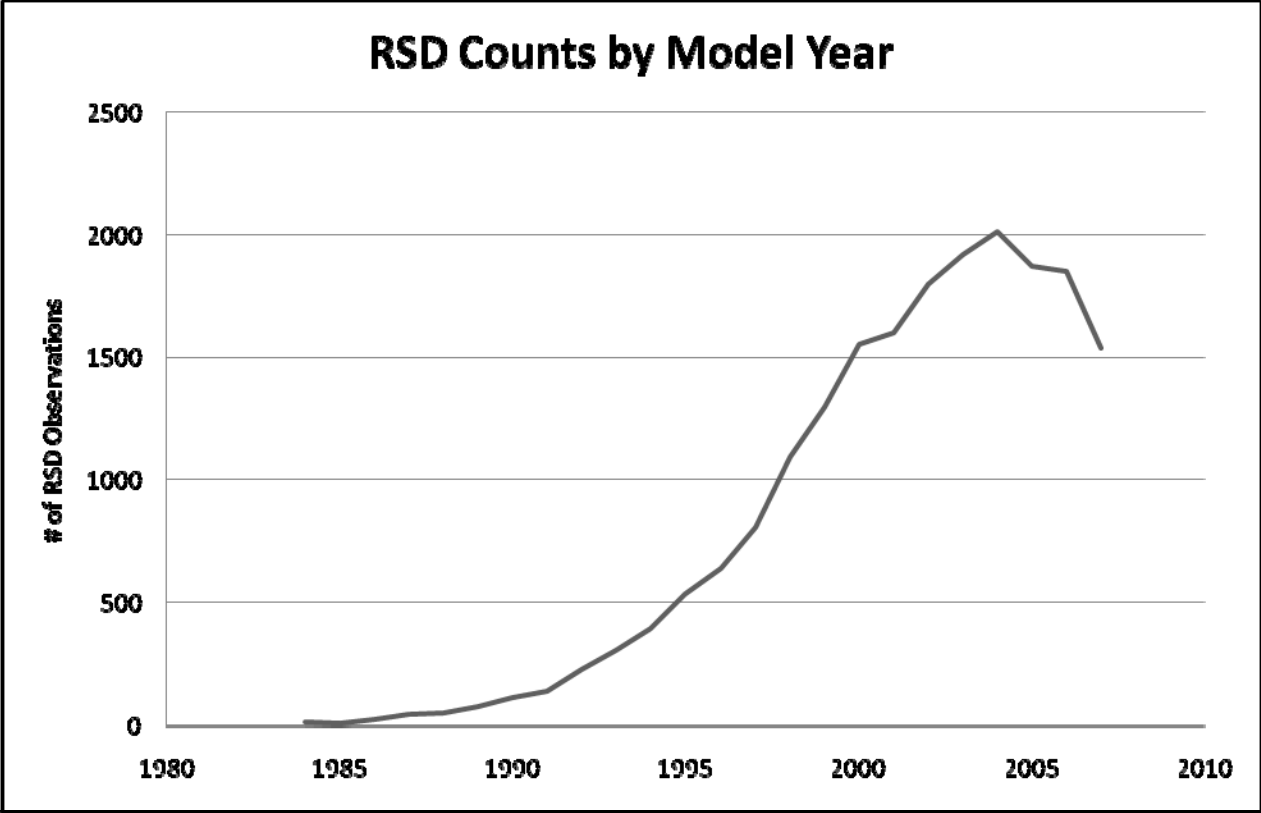

This chart shows the number of vehicles scanned by RSD by model year.

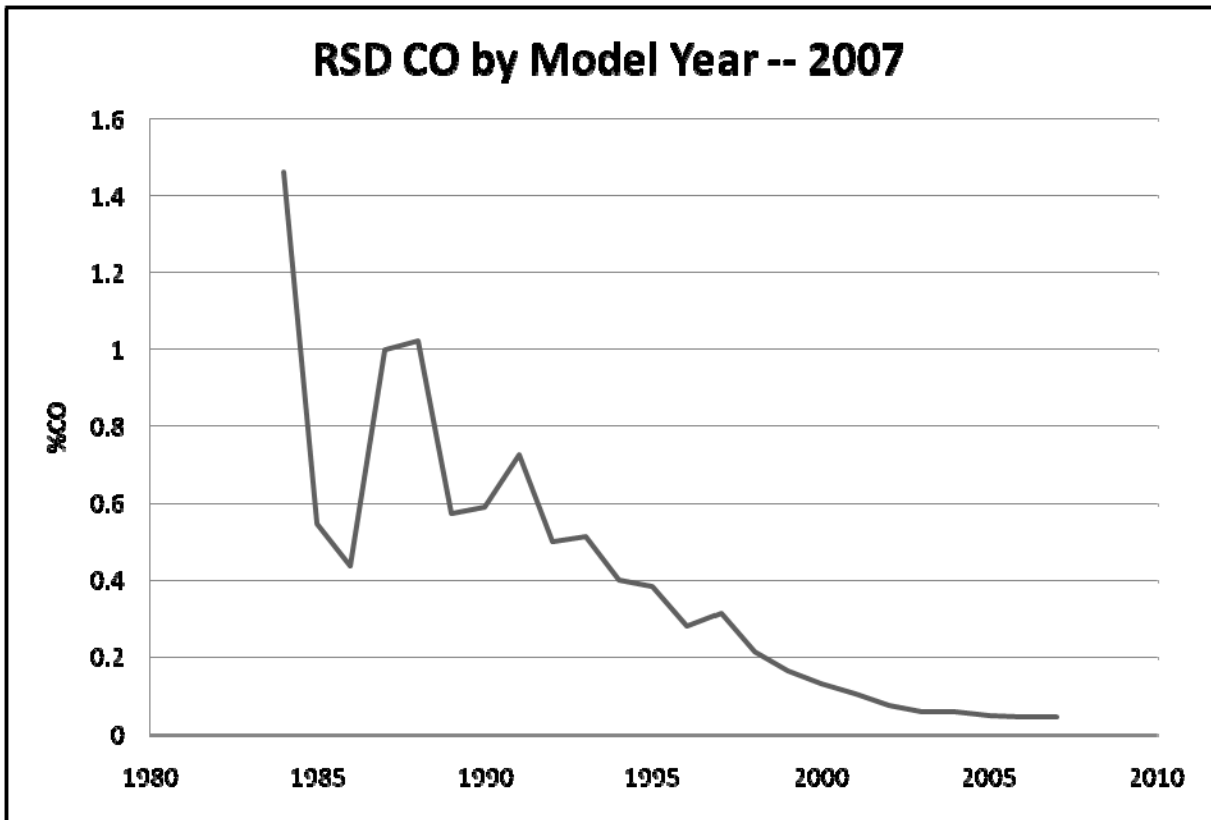

This figure shows average carbon monoxide (CO) RSD readings by model year. Increasingly more stringent EPA emission standards for newer vehicles and expected deterioration of emission controls in older vehicles result in newer vehicles having much lower emissions. The low sample sizes for the older vehicles causes considerable variation in average readings.

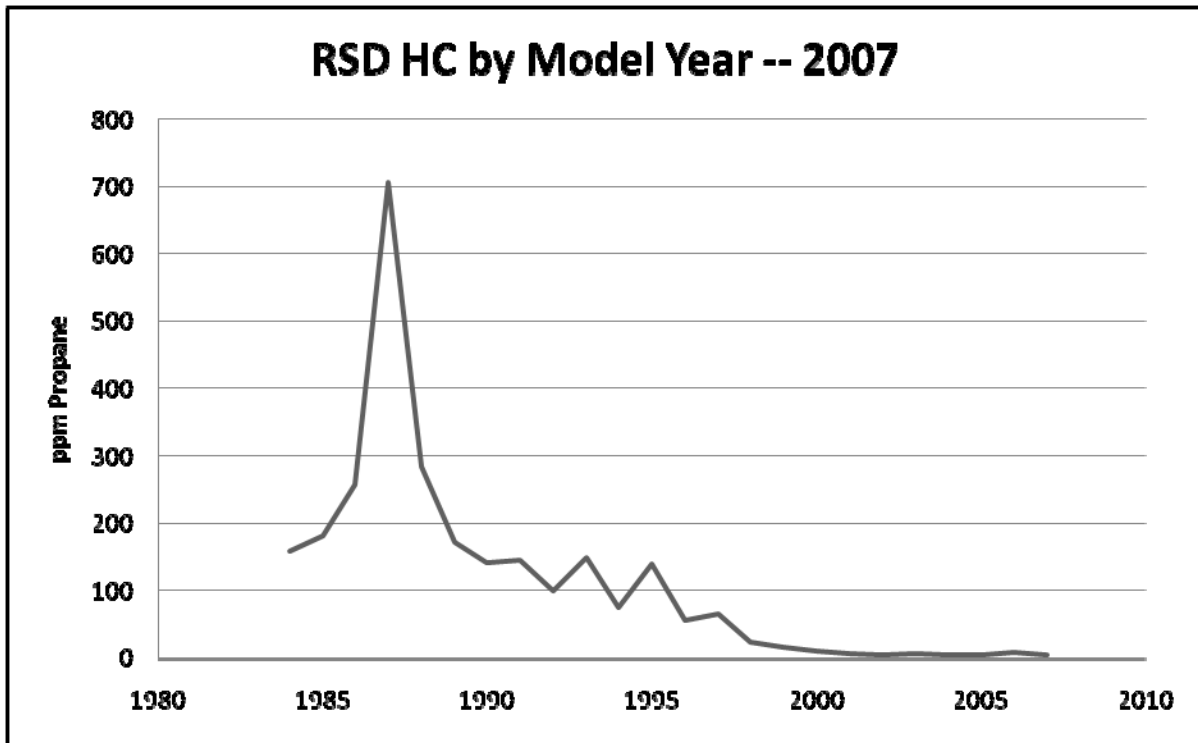

This figure shows average hydrocarbon (HC) RSD readings by model year. Propane is used as a surrogate for HC. Increasingly more stringent EPA emission standards for newer vehicles and expected deterioration of emission controls in older vehicles result in newer vehicles having much lower emissions. The low sample sizes for the older vehicles causes considerable variation in average readings.

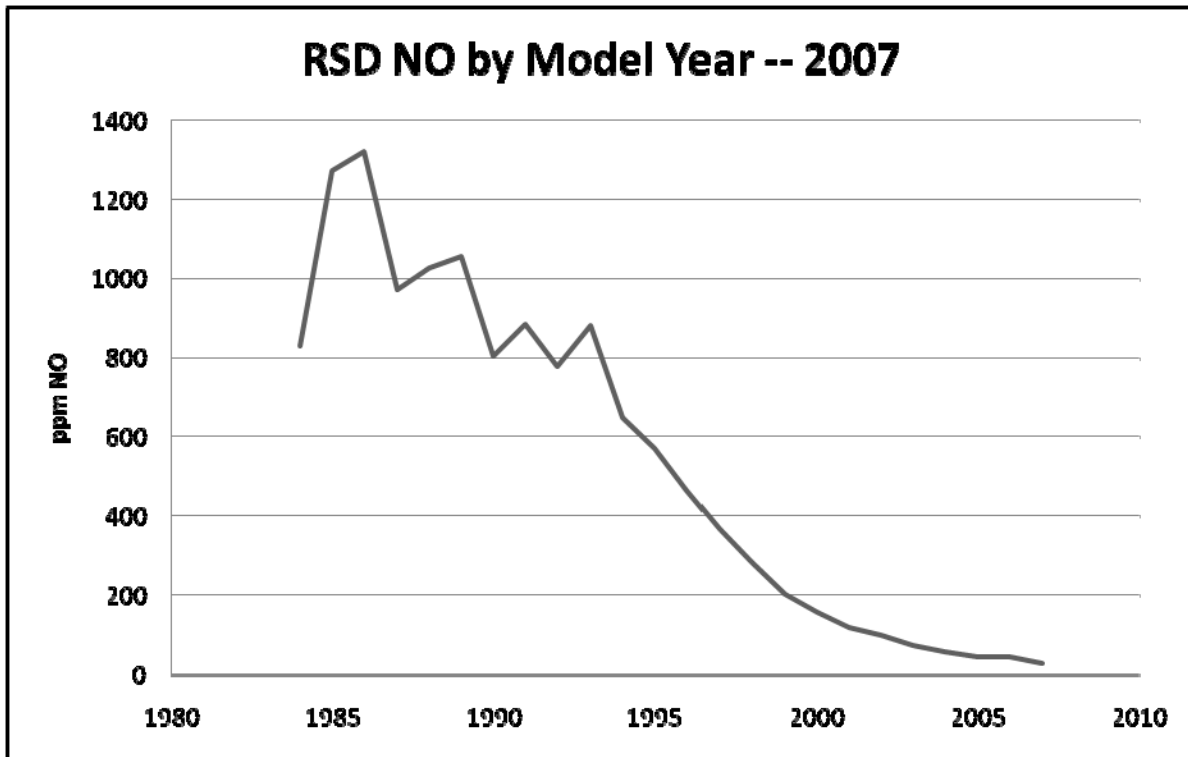

This figure shows average RSD readings for nitric oxide (NO) by model year. Increasingly more stringent EPA emission standards for newer vehicles and expected deterioration of emission controls in older vehicles result in newer vehicles having much lower emissions. The low sample sizes for the older vehicles causes considerable variation in average readings.

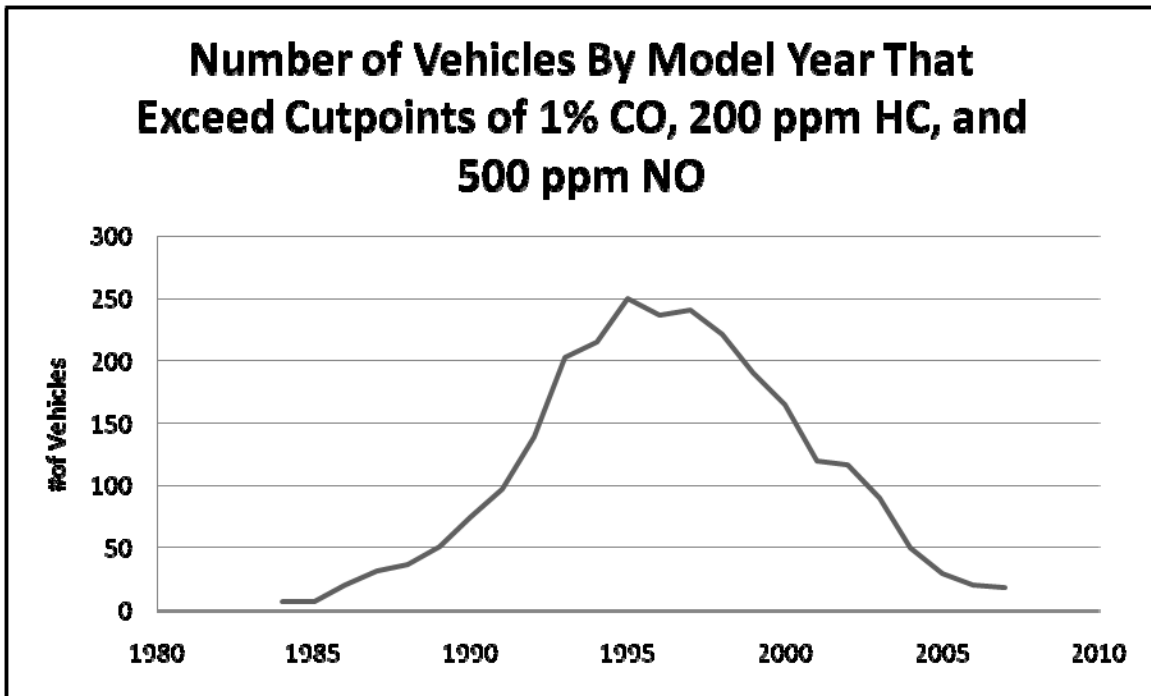

This figure shows the number of vehicles by model year that exceed cutpoints of 1% CO, 200 ppm HC, and 500 ppm NO. These cutpoints are similar to ASM2525 cutpoints for late model light-duty vehicles. These data indicate that most high emitting vehicles are 2003 and older models, which are the models included in the current program. The numbers drop off for 1990 and older models because far fewer of them are still being driven.

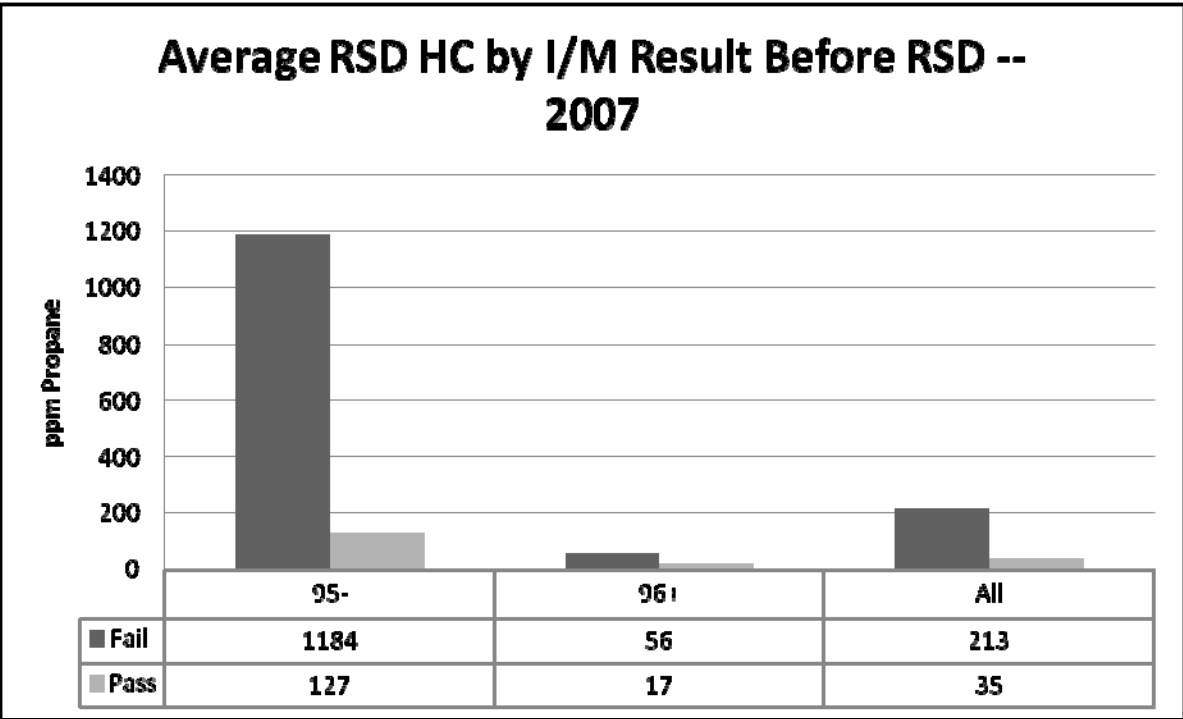

This figure shows average RSD HC emissions for vehicles that received an I/M test before they were observed by RSD. Results are broken down by model year and I/M pass/fail status of the last test before the RSD observation. RSD emission levels for vehicles that failed their I/M test were much higher than emission levels for vehicles that passed.

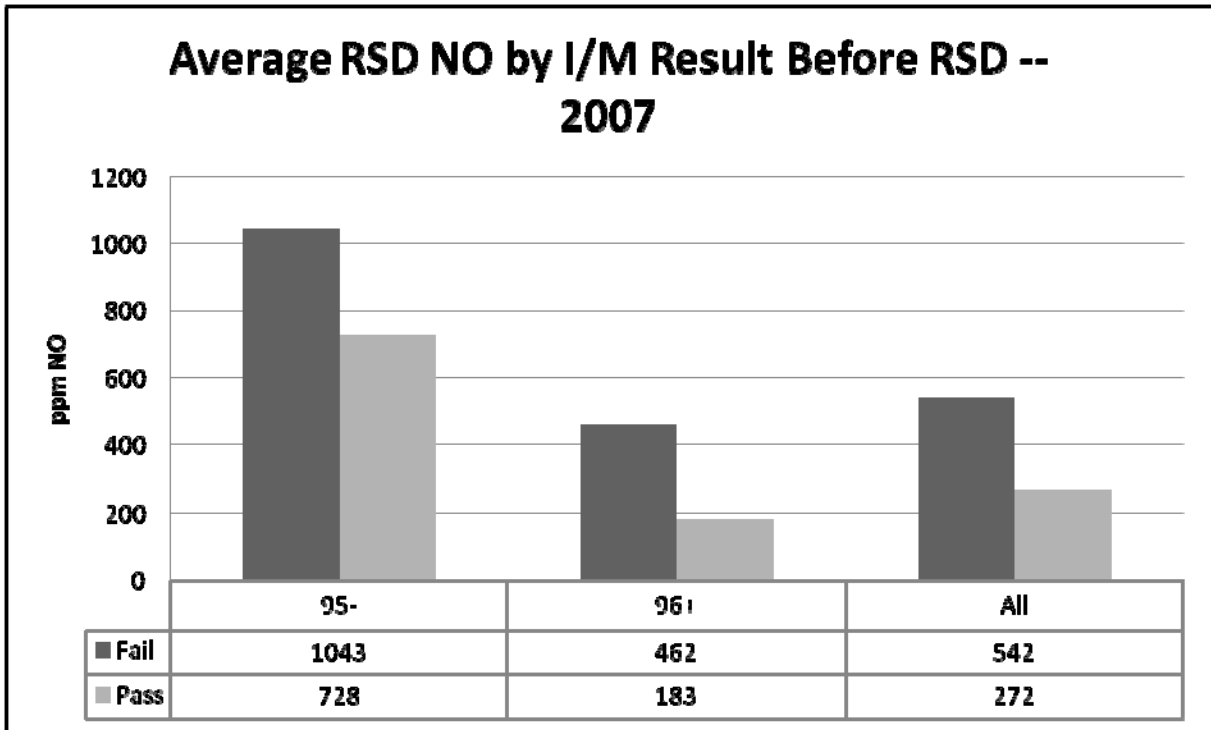

This figure shows average RSD NO emissions for vehicles that received an I/M test before they were observed by RSD. Results are broken down by model year and I/M pass/fail status of the last test before the RSD observation. RSD emission levels for vehicles that failed their I/M test were much higher than emission levels for vehicles that passed.

Emission Reduction Estimates Based on Remote Sensing Device (RSD) Readings

Based on the analysis of RSD emission levels for vehicles that received an I/M test before they were observed by RSD, dKC estimated emission reductions from the I/M program. They are shown below. Please note that these estimated emission reductions are extremely limited and should only be used as a rough assessment for the program. Results of remote sensing tests do not correlate well with mass emissions tests and cannot be compared to estimates based on mass emissions tests, but are directionally consistent with mass emission tests. The sample sizes are too small to make an accurate calculation of emission reductions for the I/M program. This comparison is mainly useful in determining if the program appears to be getting the benefits calculated by the MOBILE6 model.

HC and NO_x emissions are the primary concerns due to their role in forming ozone. HC benefits based on remote sensing tests are higher than predicted by MOBILE6, while NO_x benefits are slightly lower. dKC concludes that the program is getting the benefits predicted by MOBILE6.

Emission Reductions Based on Remote Sensing Device (RSD) Readings

Model Year	Pollutant		
	CO (%)	HC (ppm)	NO _x (ppm)
pre-1995	15.0%	45.2%	4.1%
1996+	13.6%	14.1%	9.8%
ALL	13.2%	28.7%	7.3%
MOBILE6	19.3%	13.5%	10.6%

Conclusion: Based on remote sensing data, Connecticut appears to be getting the emission reductions predicted by MOBILE6.

Emission Levels for 2003 and Newer Vehicles

Currently, Connecticut exempts the newest four model years from the I/M program. In 2007, this meant that the newest model year tested was 2003. dKC analyzed data on 2004 and newer vehicles that received RSD emissions tests to determine if there would be value in reducing the number of model year exemptions.

There were no cases of 2004 or newer models having CO > 6%, which some states use as criteria to define a gross polluter. There were few 2004 and newer vehicles that exceeded emissions levels comparable to ASM2525 cutpoints. ASM2525 pass/fail criteria for the latest models is approximately CO > 1%, HC > 200 ppm, or NOx > 500 ppm. Only 4% of the vehicles that exceeded these levels were 2004 and newer vehicles, even though 37% of the vehicles tested were 2004 and newer models.

Conclusion: Connecticut's policy of exempting the newest four model years from I/M compliance does not significantly impact the benefits from the program.

Contribution of 1995 and Older Vehicles to Total Vehicle Emissions

dKC analyzed results of the August 2007 RSD survey to estimate the contribution of 1995 and older models – the models that get tailpipe tests – to total vehicle emissions. dKC summed RSD emissions levels by model year to estimate the impact of pre-1996 vehicles on total vehicle emissions. The number of observations by model year can be used to estimate VMT by model year.

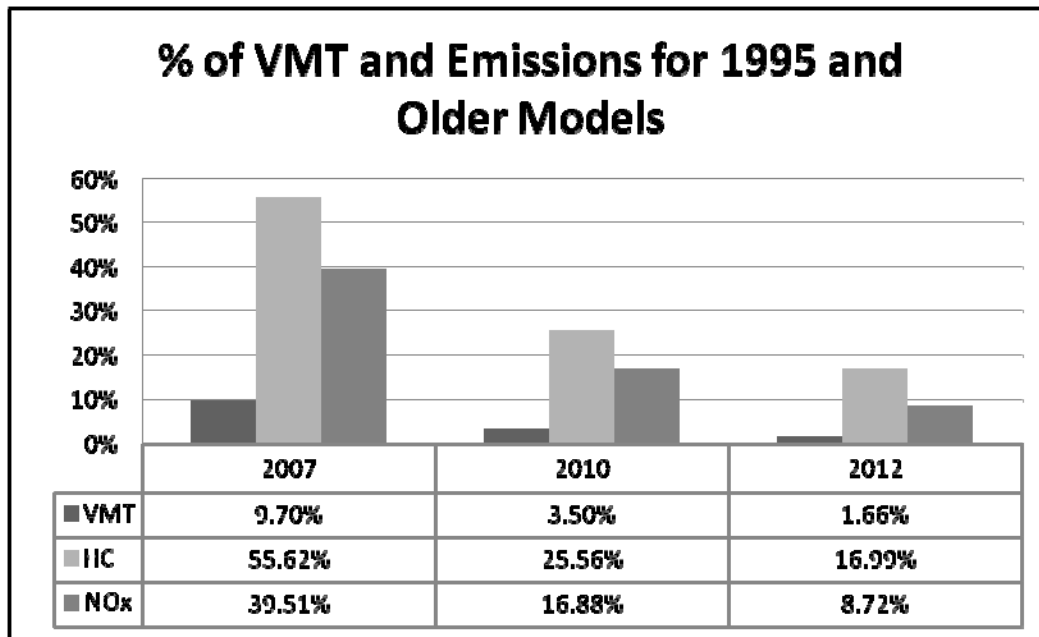

This figure shows VMT and emissions for pre-1996 vehicles as a percent of total emissions. The 2010 and 2012 values are projections based on 2007 values. Older models account for a significant fraction of vehicle emissions, even though far fewer of them were seen in the survey. Currently, pre-1996 vehicles account for 56% of the HC emissions and 40% of the NOx emissions, based on the 2007 RSD survey. These percentages drop to 26% and 17% in 2010 and 17% and 9% in 2012.

Connecticut's air quality would benefit from continuing to perform tailpipe emissions tests on 1995 and older models to ensure high emitting vehicles are identified and repaired.

7.0 Assessment of OBD Testing Issues

Fallback Tailpipe Test For Vehicles That Are Not Ready, But Otherwise Pass OBDII

During this inspection cycle, Connecticut's I/M program allowed vehicles that are not ready (>2 monitors for pre-2001 and >1 monitor for 2001 and newer) but otherwise pass the OBDII inspection to receive a back-up tailpipe test (ASM2525 or PCTSI depending on vehicle). As of July 1, 2008, the next generation of software will be utilized and these vehicles will fail. From January 1, 2006 to December 31, 2007, 21,981 vehicles (~3% of the OBDII fleet) received back-up tailpipe tests under this provision. During this period 52,324 vehicles failed their OBDII inspection because the MIL was commanded-on or the bulb did not work.

Based on inspection results, it appears that most motorists and inspection stations did not clear codes on vehicles with MILs on prior to inspection. Clearing codes could allow the vehicle to pass a tailpipe test¹², instead of failing the OBD inspection. If codes were being cleared, MIL-command-on rates would be lower and not ready rates would be higher than programs without back-up tailpipe tests. As shown on the following figures, Connecticut's MIL command-on rates are similar to Delaware's, while its not ready rates are slightly lower than Delaware's, based on data collected since 2006 and 2007. Delaware operates a centralized test-only program and has not allowed back-up tailpipe tests since January 1, 2005.

The back-up tailpipe test provision in Connecticut has not significantly impacted the benefits of Connecticut's I/M program. The latest software update terminates the back-up tailpipe test provision.

¹² Readiness status for all monitors is set to "not ready" when fault codes are cleared and the MIL is extinguished by a technician with a scan tool.

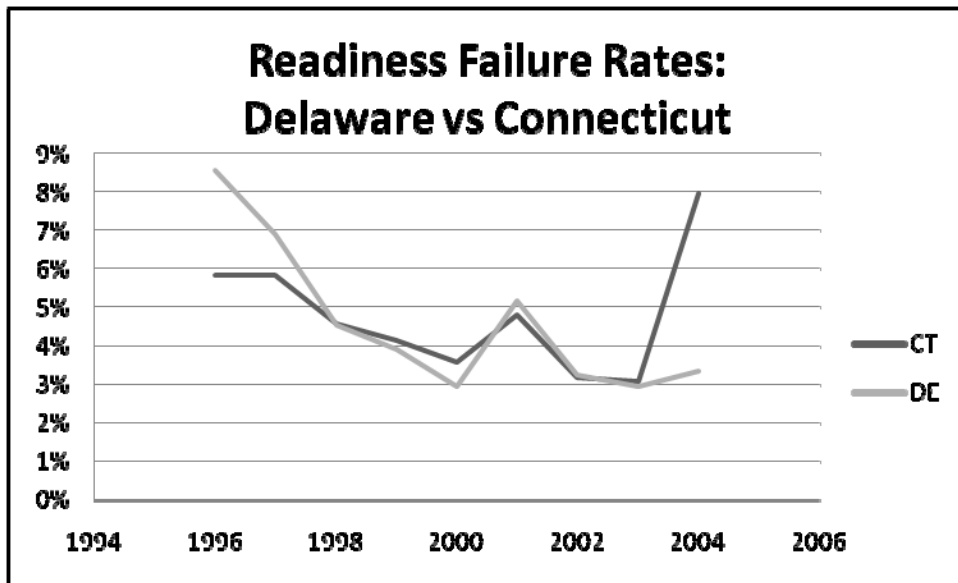
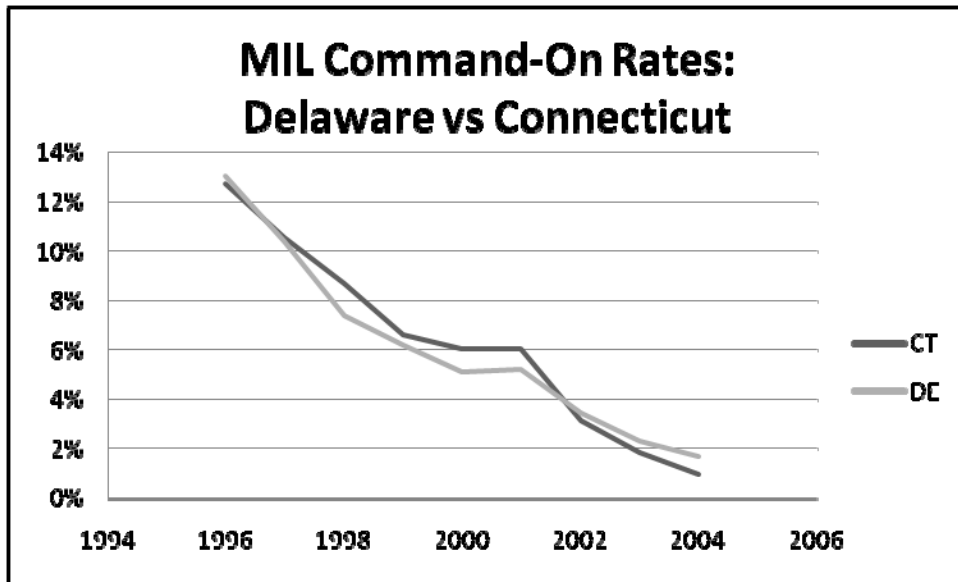

These charts compare MIL Command On failure rates and not ready rates in Connecticut with rates in Delaware. Delaware uses a State-Operated centralized scenario, and does not perform back-up tailpipe tests. The MIL Command On failure rates are nearly identical, while Connecticut has equal or slightly lower not ready rates, except for the 2004 model year, which as mentioned earlier is due to the large number of 2004 model dealer vehicles inspected in Connecticut.

Vehicles with Readiness Issues that are Not Currently Exempted from Readiness Requirements

EPA allows states to exempt vehicles from readiness requirements, if they have design flaws that cause them to frequently fail for readiness. Based on data from tests since November 11, 2004, several vehicle models that are not currently exempted from readiness by EPA have high not ready rates. Other states have reported similar problems with these vehicles. **These vehicles are listed in the following table.**

Vehicles That Should Be Added To EPA's Readiness Exemption List

Model Year	Make	Model	# OBD tested	# Not Ready	% Not Ready
1996	DODGE	AVENGER	177	57	32.2%
1996	DODGE	INTREPID	776	199	25.6%
1996	DODGE	NEON	580	174	30.0%
1996	DODGE	STRATUS	500	110	22.0%
1996	EAGLE	TALON	74	38	51.4%
1996	EAGLE	VISION	75	36	48.0%
1996	FORD	E250 SUPER VAN	13	3	23.1%
1996	FORD	PROBE	125	25	20.0%
1996	FORD	TAURUS SHO	14	4	28.6%
1996	GEO	TRACKER	300	61	20.3%
1996	HYUNDAI	ACCENT	242	51	21.1%
1996	HYUNDAI	ELANTRA	216	47	21.8%
1996	HYUNDAI	SONATA	55	29	52.7%
1996	MAZDA	MILLENNIA	75	19	25.3%
1996	MERCEDES-BENZ	S420	34	8	23.5%
1996	PLYMOUTH	NEON	501	139	27.7%
1996	PORSCHE	911 CARRERA	10	6	60.0%
1996	PORSCHE	911 TURBO	12	6	50.0%
1996	SUZUKI	X-90	27	12	44.4%
1996	VOLKSWAGEN	GTI	65	14	21.5%
1996	VOLKSWAGEN	PASSAT	296	86	29.1%
1997	CHEVROLET	G15	10	2	20.0%
1997	EAGLE	TALON	48	16	33.3%
1997	GEO	TRACKER	149	31	20.8%
1997	HYUNDAI	SONATA	153	75	49.0%
1997	KIA	SEPHIA	139	30	21.6%
1997	PORSCHE	911 CARRERA 2	58	17	29.3%
1997	PORSCHE	911 CARRERA 4	30	9	30.0%
1997	PORSCHE	911 TURBO	11	4	36.4%
1998	CHEVROLET	TRACKER	137	28	20.4%

Model Year	Make	Model	# OBD tested	# Not Ready	% Not Ready
1998	FORD	E250	16	4	25.0%
1998	HYUNDAI	SONATA	145	52	35.9%
1998	SUZUKI	SIDEKICK	20	6	30.0%
1998	TOYOTA	CELICA	37	8	21.6%
2000	PLYMOUTH	PROWLER	13	3	23.1%
2001	FORD	EXCURSION	10	6	60.0%
2001	FORD	F250	37	26	70.3%
2001	FORD	F350	15	5	33.3%
2002	BUICK	RENDEZVOUS AWD	106	28	26.4%
2002	BUICK	RENDEZVOUS FWD	33	10	30.3%
2002	CHEVROLET	BLAZER 4WD	226	57	25.2%
2002	CHRYSLER	SEBRING	117	25	21.4%
2002	CHRYSLER	VOYAGER	36	11	30.6%
2002	DODGE	RAM VAN 1500	12	3	25.0%
2002	FORD	CROWN VIC	25	15	60.0%
2002	FORD	TAURUS WAGON	35	8	22.9%
2002	GMC	SAFARI	13	3	23.1%
2002	MERCEDES-BENZ	C320	32	8	25.0%
2002	PONTIAC	AZTEK	12	4	33.3%
2002	TOYOTA	SIENNA	106	24	22.6%
2002	TOYOTA	TUNDRA 2WD	15	3	20.0%
2002	VOLVO	C70	17	7	41.2%
2002	VOLVO	V70 AWD	226	50	22.1%

Vehicles That Fail to Communicate with Connecticut's Test System

A small percentage (0.9%) of the vehicles with OBDII systems fail to communicate with Connecticut's inspection system. Currently these vehicles receive a back-up tailpipe test if there is no visual evidence that the MIL is on. The vehicles listed below have high no communication percentage. Overall, few vehicles have trouble communicating with Connecticut's OBDII test system.

Vehicles With High No Communication Rates

Model Year	Make	Model	OBD Tested	# No COM	No COM Rate
1997	ACURA	2.5TL	73	71	97%
2004	FORD	Explorer XLT	17	9	53%
2001	BMW	Z8	16	8	50%
2002	BMW	M5	16	7	44%
2000	BMW	M5	46	19	41%
2002	BMW	M3	47	18	38%
2001	BMW	M5	40	12	30%

Diagnostic Trouble Codes (DTCs) Recorded in OBDII Failures

Whenever the Malfunction Indicator Light (MIL) is illuminated a Diagnostic Trouble Code (DTC) should be stored in the vehicle's computer. DTCs describe the problem that caused the MIL to go on. Before OBDII, each manufacturer had their own specific trouble code list and code definitions. Under the OBDII requirements, all manufacturers must comply with a standardized convention for DTCs. The universal DTC format consists of a 5-character alphanumeric code, consisting of a single letter character followed by four numbers.

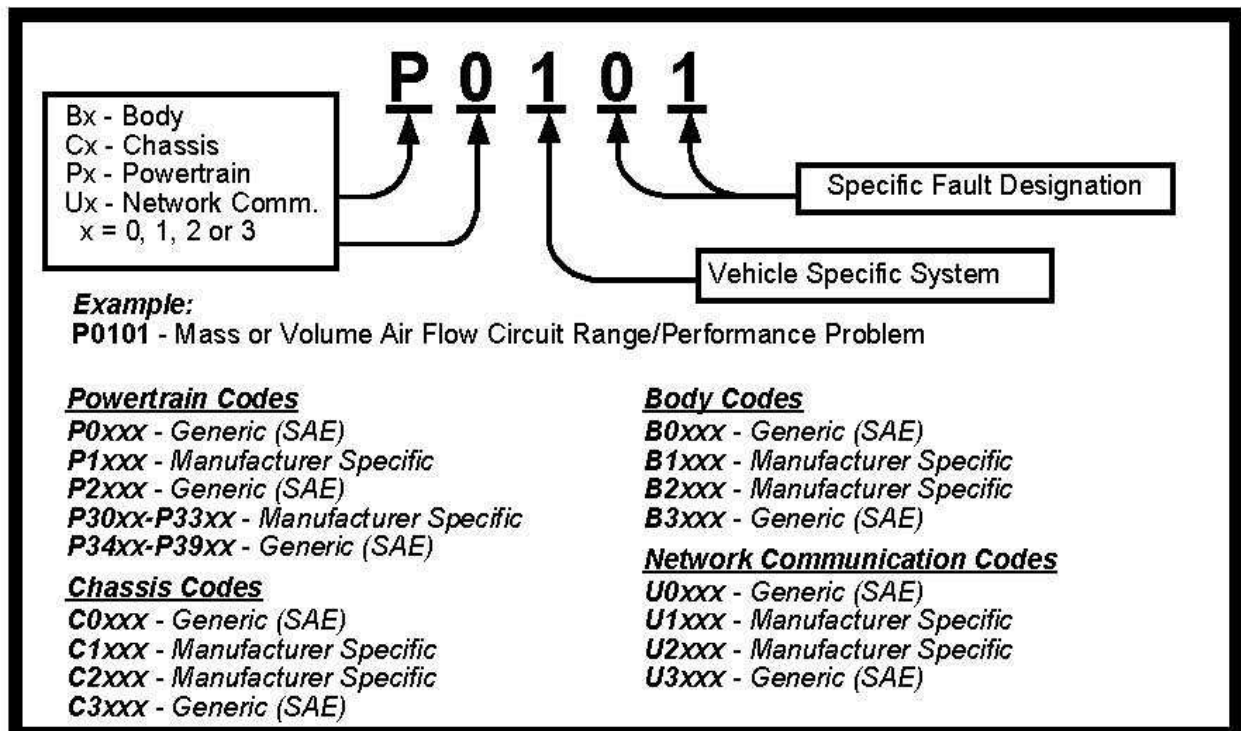

Top 10 DTCs in Connecticut

Following is a list of the most prevalent DTCs in Connecticut. Note that the top 10 DTCs are present in 63% of the MIL-on cases, even though there are over 1000 possible DTCs.

Rank	DTC	%
1	P0420 – Low Catalyst Efficiency	10.95%
2	P0171 -- System Too Lean	10.64%
3	P0401 -- EGR Flow Insufficient	7.21%
4	P0442 -- Evaporative Emission Control System Leak Detected (small leak)	6.01%
5	P0174 -- System Too Rich	5.83%
6	P0455 -- Evaporative Emission Control System Leak Detected (gross leak)	5.79%
7	P0440 -- Evaporative Emission Control System Malfunction	4.70%
8	P0300 -- Random Misfire	4.64%
9	P0141 -- O2 Sensor Heater Circuit Malfunction	3.99%
10	P0135 -- O2 Sensor Heater Circuit Malfunction	3.70%
	Total Top 10	63.47%

Comparison of Top 10 DTCs in Different States

dKC compiled data on top 10 DTCs in California and Delaware and compared this list with Connecticut's top 10 DTCs. The top 5 DTCs were similar in all 3 states, which indicates that these vehicle fleets have similar emissions related problems. Discrepancies at the bottom of the list are likely due to climate and/or emission standards differences.

Diagnostic Trouble Codes (DTC)	Rank		
	CA	CT	DE
P0420 -- Low Catalyst Efficiency	1	1	1
P0171 -- System Too Lean	2	2	2
P0401 -- EGR Flow Insufficient	3	3	3
P0174 -- System Too Rich	4	5	5
P0300 -- Random Misfire	5	8	4
P0141 -- O2 Sensor Heater Circuit Malfunction	6	9	6
P1443 -- Ford Evaporative Control Valve Failure	7	37	21
P0135 -- O2 Sensor Heater Circuit Malfunction	8	10	10
P0133 -- O2 Sensor Circuit Slow Response	9	17	7
P0455 -- Evaporative Emission Control System Leak Detected (gross leak)	10	6	15

8.0 2005 to 2007 Inspection Cycle Analysis

dKC created a dataset of 640,582 vehicles that were tested in both 2005 and 2007. The goal of our analysis was to determine the durability of repairs performed on vehicles failing in 2005.

Failure rates (overall, by test type and by model year) in 2007 were determined for the following groups of vehicles that were tested in 2005:

- Passed initial test in 2005
- Failed initial test/passed retest in 2005

The failure rate was low (7.0%) for the sample of vehicles that passed their initial test in 2005. The failure rate was much higher (19%) for the sample of vehicles that failed in 2005 and were repaired to pass.

Average ASM2525 emission rates (overall and by model year) for 1995 and older models in 2005 and 2007 were calculated for vehicles for the following groups:

- Passed initial test in 2005
- Failed initial test but passed retest in 2005

From this we can project how much emissions increase over the two year cycle.

Emissions were significantly higher two years later for vehicles that failed and were repaired to pass in 2005. On the other hand, vehicles that passed their initial test in 2005 saw minimal increases in emissions in 2007, which indicates that they were capable of maintaining good control over emissions despite their age.

The charts that follow have details on this analysis.

The high failure rates and emissions levels in 2007 for vehicles that failed and were repaired to pass in 2005 may indicate that repair quality can be significantly improved. As indicated previously on page 47, the majority of those vehicles that failed were 1995 and older model years.

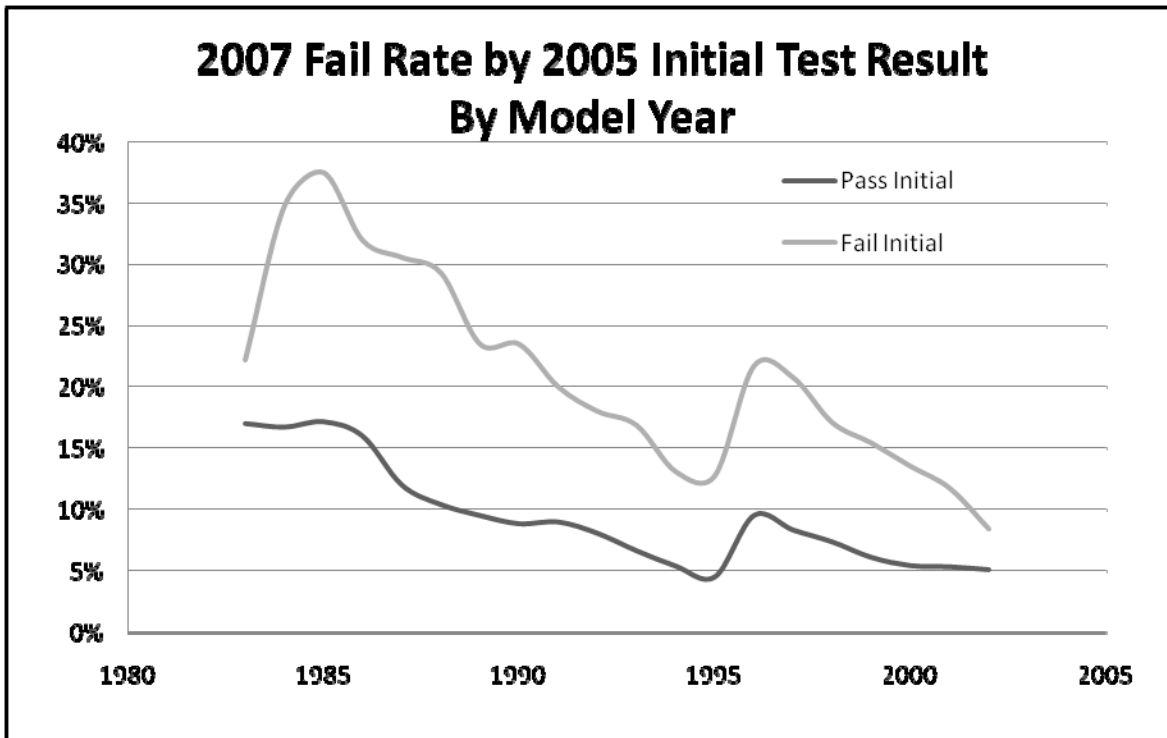

This chart shows failure rates by model year in 2007 for vehicles that passed in 2005. Failure rates in 2007 are compared for two groups of vehicles: 1) vehicles that passed their initial test in 2005 and 2) vehicles that failed and were repaired to pass in 2005. The second group, comprised mostly of 1995 and older model year vehicles, had much higher failure rates in 2007, indicating that these vehicles may be more prone to failing I/M inspections.

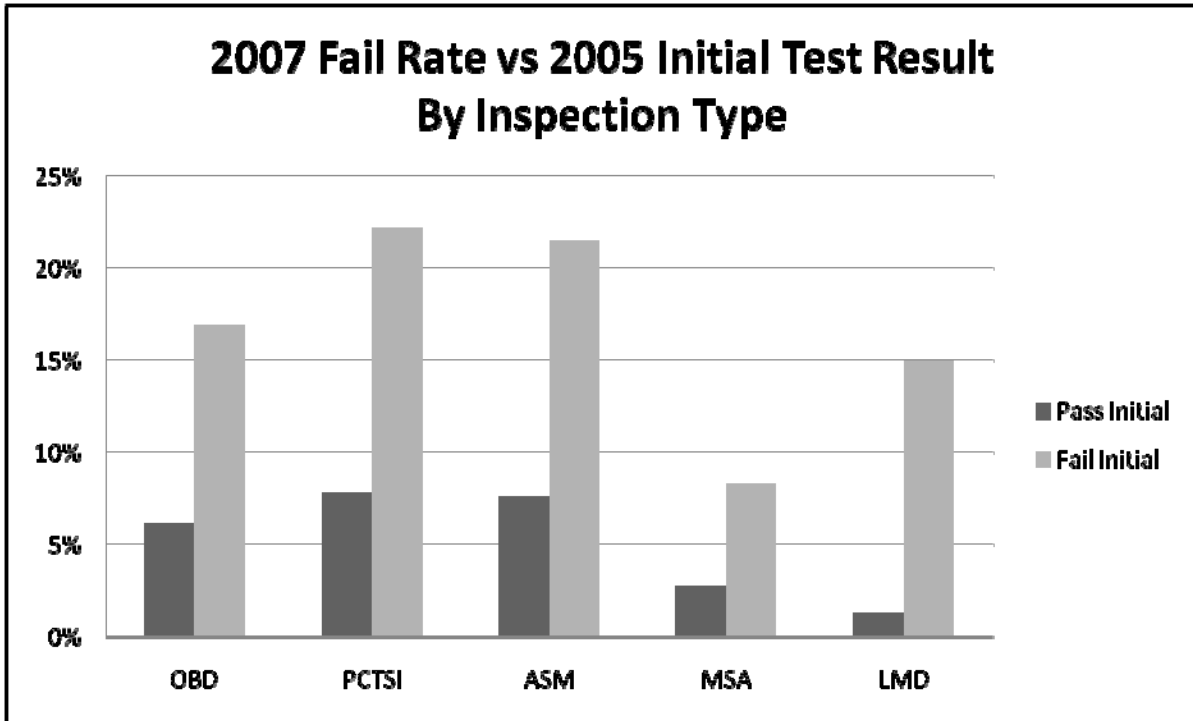

This chart shows failure rates by inspection type in 2007 for vehicles that passed in 2005. Failure rates in 2007 are compared for two groups of vehicles: 1) vehicles that passed their initial test in 2005 and 2) vehicles that failed and were repaired to pass in 2005. The second group had much higher failure rates in 2007 for all inspection types indicating that these vehicles may be more prone to failing I/M inspections.

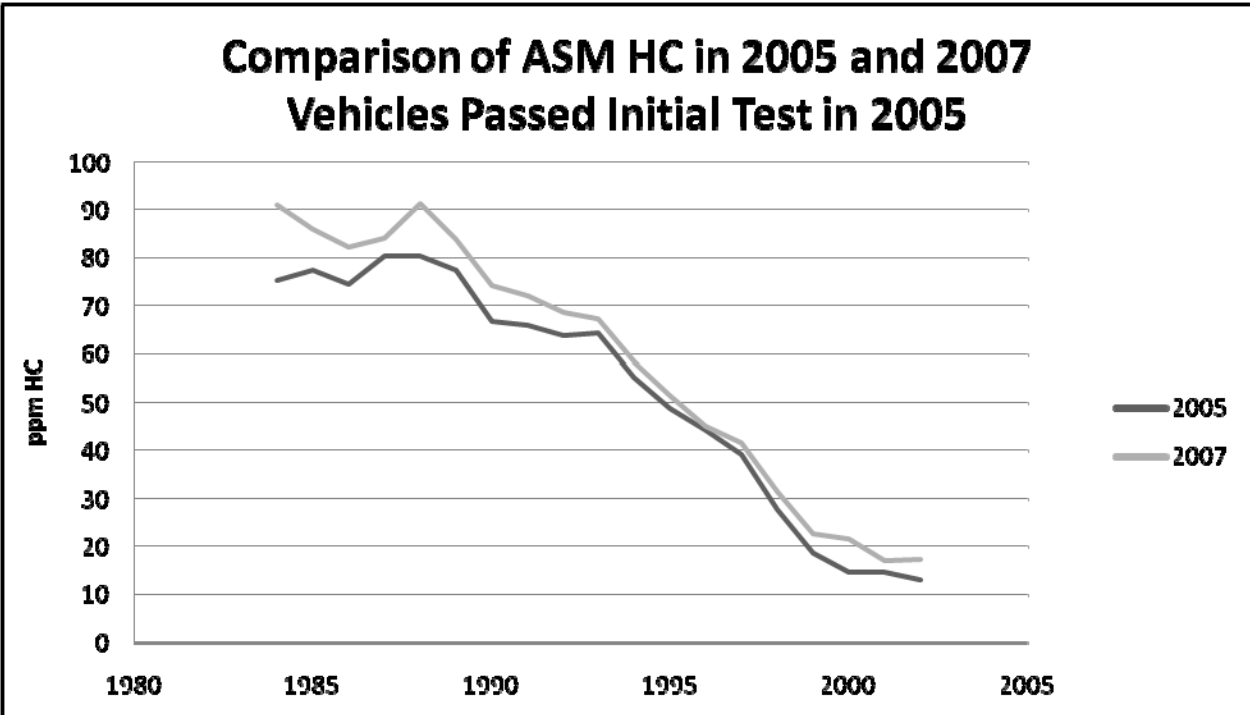

This chart shows average HC emissions by model year in 2005 and 2007 for vehicles that passed their initial test in 2005. Emissions increase slightly from 2005 to 2007. This indicates that many older vehicles can maintain low emissions levels.

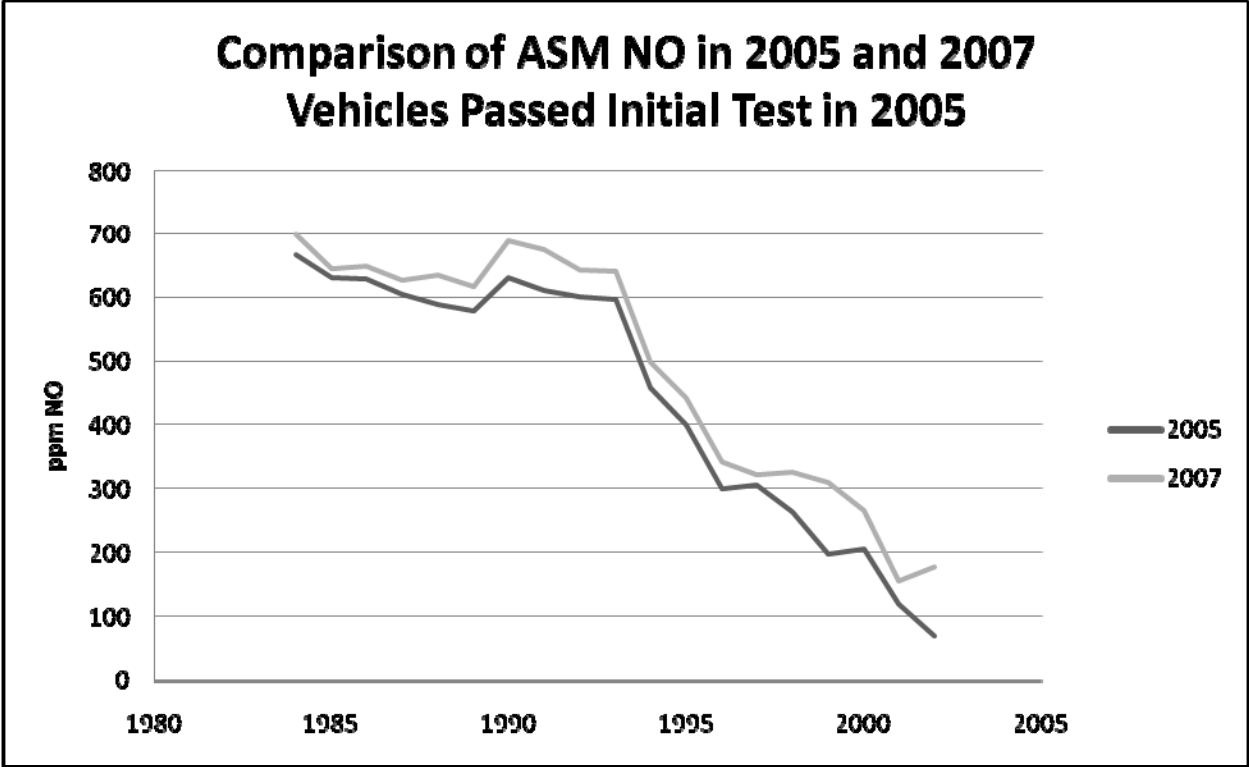

This chart shows average NO emissions by model year in 2005 and 2007 for vehicles that passed their initial test in 2005. Emissions increase slightly from 2005 to 2007. This indicates that many older vehicles can maintain low emissions levels.

Comparison of ASM HC in 2005 and 2007 Vehicles That Failed Initial Test/Passed Retest in 2005

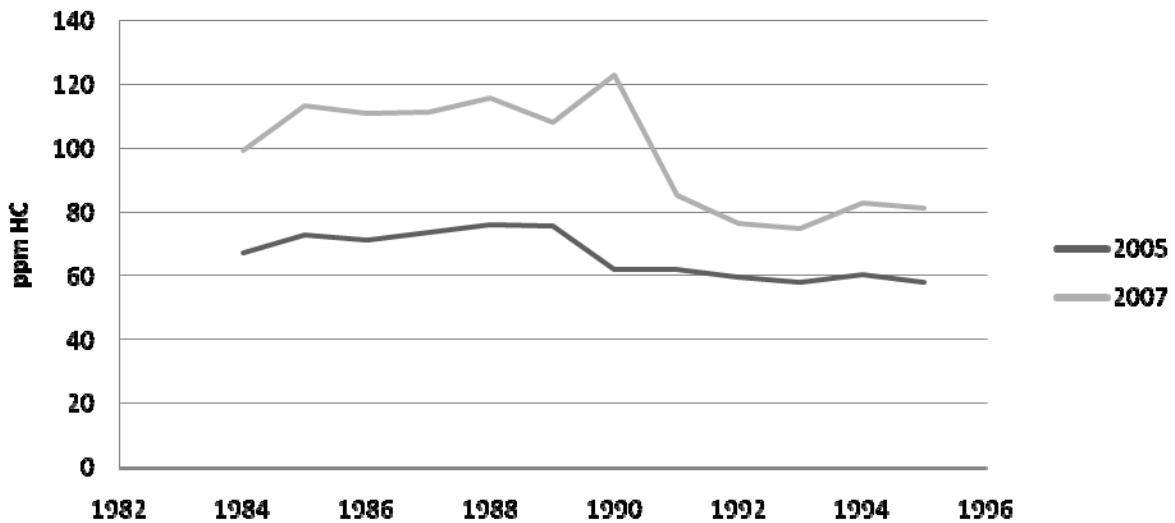

This chart shows average HC emissions by model year in 2005 and 2007 for vehicles that passed their retest in 2005. Emissions increase significantly from 2005 to 2007. This may indicate that many repairs may not have fully addressed the emissions problem in any given vehicle. There were not enough 1996 and newer models for a meaningful comparison.

Comparison of ASM NO in 2005 and 2007 Vehicles That Failed Initial Test/Passed Retest in 2005

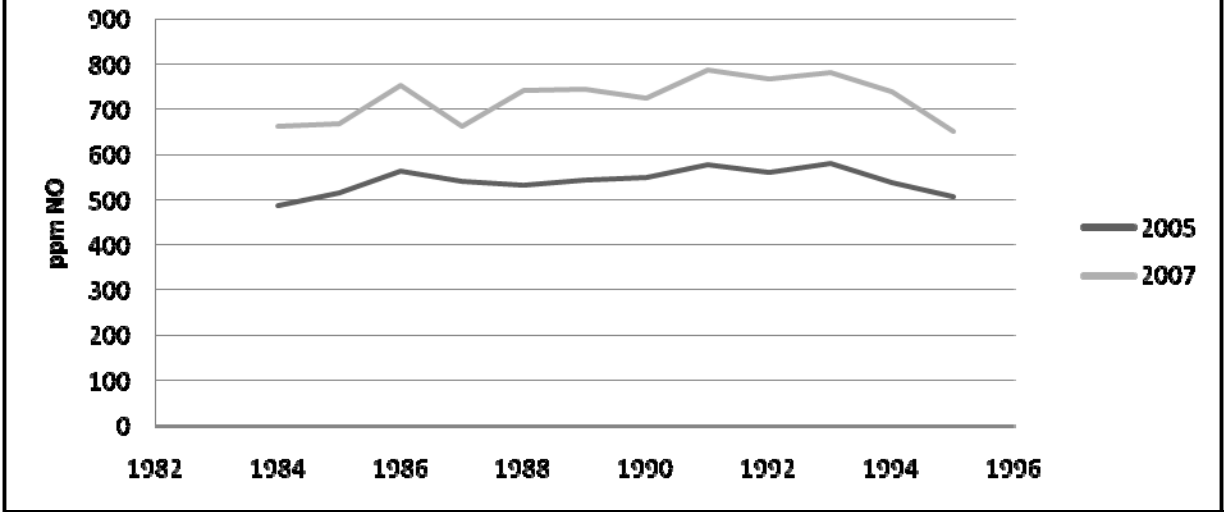

This chart shows average NO emissions by model year in 2005 and 2007 for vehicles that passed their retest in 2005. Emissions increase significantly from 2005 to 2007. This may indicate that many repairs may not have fully addressed the emissions problem in any given vehicle. There were not enough 1996 and newer models for a meaningful comparison.

9.0 Future Program Enhancements

DEP and DMV evaluate Connecticut's I/M program to ensure that it continues to operate accurately and effectively while guaranteeing the air quality benefits are achieved. Following are preliminary findings of an assessment by DEP and DMV of future options for Connecticut's program:

- ❖ Even though some states are dropping tailpipe tests, continuing tailpipe tests on pre-1996 vehicles in its I/M program maintains the air quality benefits necessary due to Clean Air Act requirements and statutory restrictions.
- ❖ Remote sensing devices (RSD) cannot be used as an alternative to periodic I/M tests. Use of RSD have been proposed as an alternative to tailpipe tests. However, RSD have severe drawbacks that limit their potential as an alternative to traditional tailpipe or OBDII emissions tests. Use of RSD is not a reliable method to identify individual high emitting vehicles. In addition, obtaining RSD emission measurements on a majority of the fleet by will cost much more than performing periodic I/M tests.
- ❖ Customer convenience can be enhanced by implementing innovative OBDII inspection strategies. Self service kiosks, wireless OBD and other innovative ways to perform OBDII inspections could be incorporated into Connecticut's next I/M program on a trial or pilot basis. However, traditional inspection stations will likely be used inspect most vehicles.

10.0 Conclusions

Following are the key conclusions from this analysis:

- ❖ Connecticut is failing the expected fraction of vehicles because they have evidence of being high emitters. Overall, almost 141,775 vehicles failed their initial emissions test in the 2006-2007 period. This equates to 7.9% of the vehicles tested.
- ❖ Over 96% of vehicle subject to I/M requirements comply with standards. 29% of the failures during the first quarter of 2007 test period did not receive a passing result or waiver by the end of 2007. Ultimately these vehicles must comply, since compliance with I/M standards is now a prerequisite to vehicle registration. The enforcement of Connecticut's I/M program exceeds the enforcement levels assumed in emissions modeling for the ozone SIP.
- ❖ The State and its contractor, Applus, perform all the Quality Assurance (QA) audits required by EPA at frequencies that greatly exceed EPA's requirements. Connecticut exceeds EPA's recommended levels of QA. The program performs accurate inspections.
- ❖ Connecticut conducts extensive enforcement activities on the I/M program. Connecticut is a national model for these types of enforcement activities. Consequently, Connecticut's I/M program has little fraud.
- ❖ Connecticut's I/M test identifies vehicles that were observed to have high emissions during independent on-road remote sensing tests. The fraction failing tailpipe and OBDII tests has much higher average emissions than the fraction that passes. OBDII and tailpipe tests identify vehicles with high emissions levels.
- ❖ Based on remote sensing data, older vehicles without OBDII systems may contribute significant amounts of pollution now and in the future. Connecticut air quality would benefit from continuing to perform tailpipe emissions tests.
- ❖ Based on remote sensing data, there appears to be no significant air quality impact of exempting the newest four model years from emissions testing.
- ❖ The high failure rates and emissions levels in 2007 for vehicles that failed and were repaired to pass in 2005 indicate that repair quality can be significantly improved.

Appendix A

EPA Checklist

Appendix A:
40 CFR Part 51 - Subpart S Inspection/Maintenance Program Requirements
51.366 - Data Analysis and Reporting Requirements

<u>Reporting Requirement</u>	<u>Reviewer Comments / Location in State Report</u>	<u>Has the State Met the Requirement?</u>
<p>(a) Test Data Report</p> <p>The program shall submit to EPA by July of each year a report providing basic statistics on the testing program for January through December of the previous year, including:</p>		
<p>(1) The number of vehicles tested by model year and vehicle type;</p>		
<p>(2) By model year and vehicle type, the number and percentage of vehicles:</p>		
<p>(i) Failing initially, per test type;</p>		
<p>(ii) Failing the first retest per test type;</p>		
<p>(iii) Passing the first retest per test type;</p>		
<p>(iv) Initially failed vehicles passing the second or subsequent retest per test type;</p>		
<p>(v) Initially failed vehicles receiving a waiver; and</p>		

<u>Reporting Requirement</u>	<u>Reviewer Comments / Location in State Report</u>	<u>Has the State Met the Requirement?</u>
(vi) Vehicles with no known final outcome (regardless of reason). (vii)-(x) [Reserved]		
(xi) Passing the on-board diagnostic check;		
(xii) Failing the on-board diagnostic check;		
(xiii) Failing the on-board diagnostic check and passing the tailpipe test (if applicable);		
(xiv) Failing the on-board diagnostic check and failing the tailpipe test (if applicable);		
(xv) Passing the on-board diagnostic check and failing the I/M gas cap evaporative system test (if applicable);		
(xvi) Failing the on-board diagnostic check and passing the I/M gas cap evaporative system test (if applicable);		
(xvii) Passing both the on-board diagnostic check and I/M gas cap evaporative system test (if applicable);		
(xviii) Failing both the on-board diagnostic check and I/M gas cap evaporative system test (if applicable);		
(xix) MIL is commanded on and no codes are stored;		
(xx) MIL is not commanded on and codes are stored;		

<u>Reporting Requirement</u>	<u>Reviewer Comments / Location in State Report</u>	<u>Has the State Met the Requirement?</u>
(xxi) MIL is commanded on and codes are stored;		
(xxii) MIL is not commanded on and codes are not stored;		
(xxiii) Readiness status indicates that the evaluation is not complete for any module supported by on-board diagnostic systems;		
(3) The initial test volume by model year and test station;		
(4) The initial test failure rate by model year and test station; and		
(5) The average increase or decrease in tailpipe emission levels for HC, CO, and NOX (if applicable) after repairs by model year and vehicle type for vehicles receiving a mass emissions test.		
<p data-bbox="71 1062 478 1097">(b) Quality assurance report.</p> <p data-bbox="71 1138 835 1279">The program shall submit to EPA by July of each year a report providing basic statistics on the quality assurance program for January through December of the previous year, including:</p>		
(1) The number of inspection stations and lanes:		

<u>Reporting Requirement</u>	<u>Reviewer Comments / Location in State Report</u>	<u>Has the State Met the Requirement?</u>
(i) Operating throughout the year; and		
(2) The number of inspection stations and lanes operating throughout the year:		
(i) Receiving overt performance audits in the year;		
(ii) Not receiving overt performance audits in the year;		
(iii) Receiving covert performance audits in the year;		
(iv) Not receiving covert performance audits in the year; and		
(v) That have been shut down as a result of overt performance audits;		
(3) The number of covert audits:		
(i) Conducted with the vehicle set to fail per test type;		
(ii) Conducted with the vehicle set to fail any combination of two or more test types;		
(iii) Resulting in a false pass per test type;		
(iv) Resulting in a false pass for any combination of two or more test types;		
(4) The number of inspectors and stations:		

<u>Reporting Requirement</u>	<u>Reviewer Comments / Location in State Report</u>	<u>Has the State Met the Requirement?</u>
(i) That were suspended, fired, or otherwise prohibited from testing as a result of covert audits;		
(ii) That were suspended, fired, or otherwise prohibited from testing for other causes; and		
(iii) That received fines;		
(5) The number of inspectors licensed or certified to conduct testing;		
(6) The number of hearings:		
(i) Held to consider adverse actions against inspectors and stations; and		
(ii) Resulting in adverse actions against inspectors and stations;		
(7) The total amount collected in fines from inspectors and stations by type of violation;		
(8) The total number of covert vehicles available for undercover audits over the year; and		
(9) The number of covert auditors available for undercover audits.		

<u>Reporting Requirement</u>	<u>Reviewer Comments / Location in State Report</u>	<u>Has the State Met the Requirement?</u>
<p>(c) Quality control report</p> <p>The program shall submit to EPA by July of each year a report providing basic statistics on the quality control program for January through December of the previous year, including:</p>		
<p>(1) The number of emission testing sites and lanes in use in the program;</p>		
<p>(2) The number of equipment audits by station and lane;</p>		
<p>(3) The number and percentage of stations that have failed equipment audits; and</p>		
<p>(4) Number and percentage of stations and lanes shut down as a result of equipment audits.</p>		
<p>(d) Enforcement report.</p> <p>(1) All varieties of enforcement programs shall, at a minimum, submit to EPA by July of each year a report providing basic statistics on the enforcement program for January through December of the previous year, including:</p>		
<p>(i) An estimate of the number of vehicles subject to the inspection program, including the results of an analysis of the registration data base;</p>		

<u>Reporting Requirement</u>	<u>Reviewer Comments / Location in State Report</u>	<u>Has the State Met the Requirement?</u>
(ii) The percentage of motorist compliance based upon a comparison of the number of valid final tests with the number of subject vehicles;		
(iii) The total number of compliance documents issued to inspection stations;		
(iv) The number of missing compliance documents;		
(v) The number of time extensions and other exemptions granted to motorists; and		
(vi) The number of compliance surveys conducted, number of vehicles surveyed in each, and the compliance rates found.		
(2) Registration denial based enforcement programs shall provide the following additional information:		
(i) A report of the program's efforts and actions to prevent motorists from falsely registering vehicles out of the program area or falsely changing fuel type or weight class on the vehicle registration, and the results of special studies to investigate the frequency of such activity; and		
(ii) The number of registration file audits, number of registrations reviewed, and compliance rates found in such audits.		

<u>Reporting Requirement</u>	<u>Reviewer Comments / Location in State Report</u>	<u>Has the State Met the Requirement?</u>
(3) Computer-matching based enforcement programs shall provide the following additional information:		
(i) The number and percentage of subject vehicles that were tested by the initial deadline, and by other milestones in the cycle;		
(ii) A report on the program's efforts to detect and enforce against motorists falsely changing vehicle classifications to circumvent program requirements, and the frequency of this type of activity; and		
(iii) The number of enforcement system audits, and the error rate found during those audits.		
(4) Sticker-based enforcement systems shall provide the following additional information:		
(i) A report on the program's efforts to prevent, detect, and enforce against sticker theft and counterfeiting, and the frequency of this type of activity;		
(ii) A report on the program's efforts to detect and enforce against motorists falsely changing vehicle classifications to circumvent program requirements, and the frequency of this type of activity; and		
(iii) The number of parking lot sticker audits conducted, the number of vehicles surveyed in each, and the		

<u>Reporting Requirement</u>	<u>Reviewer Comments / Location in State Report</u>	<u>Has the State Met the Requirement?</u>
noncompliance rate found during those audits.		
<p data-bbox="92 396 615 428">(e) Additional reporting requirements.</p> <p data-bbox="71 469 800 610">In addition to the annual reports in paragraphs (a) through (d) of this section, programs shall submit to EPA by July of every other year, biennial reports addressing:</p>		
<p data-bbox="71 656 852 797">(1) Any changes made in program design, funding, personnel levels, procedures, regulations, and legal authority, with detailed discussion and evaluation of the impact on the program of all such changes; and</p>		
<p data-bbox="71 839 800 1016">(2) Any weaknesses or problems identified in the program within the two-year reporting period, what steps have already been taken to correct those problems, the results of those steps, and any future efforts planned.</p>		

Appendix B
2007 CT I/M Program Data

Appendix B 2007 CT I/M Program Data

Table of Contents

Test Data Report

Table (a) (1). Number of Vehicles Tested by Model Year and Vehicle Type Includes Initial Tests and Retests	1
Table (a) (2) (i). Initial Test Results	2
Table (a) (2) (ii, iii). First Retest Results	7
Table (a) (2)(iv). Second and Later Retest Results	11
Table (a) (2)(v). Waivers Issued.....	15
Table (a) (2)(vi). Vehicles with No Final Pass	16
Table (a) (2)(xi, xii). Passing and Failing OBD Tests	18
Table (a) (2) (xix, xxi, xxii). # Fail for MIL Commanded On.....	19
Table (a) (2)(xix, xxi, xxii). % Fail for MIL Commanded On	19
Table (a) (2)(xxiii). # and % Not Ready	21
Table (a) (3 & 4). # of Tests by Station, % Fail By Station	22

Quality Assurance Report

Table (b) (1) & (2)(i, ii, & v). Quality Assurance	157
Table (b) (2)(iii, iv) & (3, 8, 9). Quality Assurance	157
Table (b) (4)(i & ii). Quality Assurance	157
Table (b) (5). # of licensed inspectors	157
Table (d) (1)(v). # of time extensions and exemptions granted to motorists	158
Table (d) (3)(i). # and % of subject vehicles that were tested by the initial deadline	158

Quality Control Report

Table (c) (1,2,3 & 4).....	159
------------------------------	-----

Enforcement Report

Enforcement Report: (d) (1)(i & ii), (2), & (3)(ii & iii)	167
---	-----

Table (a) (1).			
Number of Vehicles Tested by Model Year and Vehicle Type			
Includes Initial Tests and Retests			
Model Year	Passenger car (P)	Truck (T)	Total
1981	6	1	7
1982	14	9	23
1983	433	212	645
1984	2576	1449	4025
1985	3764	2056	5820
1986	5128	3349	8477
1987	6949	4216	11166
1988	8243	5889	14132
1989	10568	6242	16811
1990	12993	5010	18003
1991	14931	5352	20284
1992	19978	6865	26845
1993	25193	10843	36036
1994	29585	16881	46469
1995	40031	21672	61704
1996	38878	21596	60483
1997	50584	29781	80372
1998	49441	31472	80916
1999	63371	41933	105315
2000	92476	58964	151455
2001	87537	56928	144478
2002	26609	19760	46391
2003	82982	71298	154541
2004	14973	14724	29712
2005	13	5	19
2006	8	2	10
2007	2		2
Grand Total	687,266	436,509	1,123,775

Table (a) (2)(i). Initial Test Results							
Test Type	Vehicle Type	Model Year	# Fail	# Pass	Total	% Fail	
OBD	P	1992		1	1	0%	
		1993		2	2	0%	
		1996	4523	28740	33263	14%	
		1997	4746	39431	44177	11%	
		1998	4155	39695	43850	9%	
		1999	4486	52849	57335	8%	
		2000	5568	79659	85227	7%	
		2001	4597	76247	80844	6%	
		2002	1252	22923	24175	5%	
		2003	1848	77715	79563	2%	
		2004	168	13483	13651	1%	
		2005		9	9	0%	
		2006		4	4	0%	
	P Total			31,343	430,758	462,101	7%
	T	1993			2	2	0%
		1996	2509	14286	16795	15%	
		1997	2903	20364	23267	12%	
		1998	2647	23797	26444	10%	
		1999	2676	32443	35119	8%	
		2000	3294	46927	50221	7%	
		2001	3700	42792	46492	8%	
		2002	1214	14834	16048	8%	
		2003	1958	60298	62256	3%	
2004		260	12343	12603	2%		
2005		3	3	0%			
T Total			21,161	268,089	289,250	7%	
OBD Total			52,504	698,847	751,351	7%	

Table (a) (2)(i). Initial Test Results							
Test Type	Vehicle Type	Model Year	# Fail	# Pass	Total	% Fail	
PCTSI	P	1983	1	2	3	33%	
		1984	2	9	11	18%	
		1985	10	15	25	40%	
		1986	9	23	32	28%	
		1987	10	32	42	24%	
		1988	21	66	87	24%	
		1989	7	96	103	7%	
		1990	46	366	412	11%	
		1991	83	613	696	12%	
		1992	109	1025	1134	10%	
		1993	180	1720	1900	9%	
		1994	138	1573	1711	8%	
		1995	220	2905	3125	7%	
		1996	6	150	156	4%	
		1997	8	242	250	3%	
		1998	8	190	198	4%	
		1999	6	342	348	2%	
		2000	2	262	264	1%	
		2001	7	404	411	2%	
		2002	7	208	215	3%	
	2003	14	317	331	4%		
	2004	2	237	239	1%		
	2005		1	1	0%		
	2006		2	2	0%		
	2007		1	1	0%		
	P Total			896	10,801	11,697	8%
	T		1982	1	1	2	50%
			1983	6	9	15	40%
			1984	83	92	175	47%
			1985	110	129	239	46%
			1986	162	251	413	39%
			1987	138	301	439	31%
			1988	128	398	526	24%
1989			139	512	651	21%	
1990			73	343	416	18%	
1991			64	421	485	13%	
1992			68	511	579	12%	
1993			148	1461	1609	9%	
1994			239	2292	2531	9%	
1995			341	3306	3647	9%	
1996			112	993	1105	10%	
1997			123	1780	1903	6%	
1998			66	1258	1324	5%	
1999	82	2203	2285	4%			
2000	167	3258	3425	5%			
2001	302	3816	4118	7%			
2002	94	1324	1418	7%			
2003	265	4532	4797	6%			
2004	25	1146	1171	2%			
2005		1	1	0%			
2006		2	2	0%			
T Total			2,936	30,340	33,276	9%	
PCTSI Total			3,832	41,141	44,973	9%	

Table (a) (2)(i). Initial Test Results							
Test Type	Vehicle Type	Model Year	# Fail	# Pass	Total	% Fail	
ASM	P	1981	1	1	2	50%	
		1982	1	3	4	25%	
		1983	87	190	277	31%	
		1984	459	1366	1825	25%	
		1985	664	2011	2675	25%	
		1986	856	3142	3998	21%	
		1987	1034	4546	5580	19%	
		1988	1102	5818	6920	16%	
		1989	1166	7927	9093	13%	
		1990	1452	9503	10955	13%	
		1991	1545	10916	12461	12%	
		1992	1857	14732	16589	11%	
		1993	2003	18888	20891	10%	
		1994	1982	23672	25654	8%	
		1995	2144	32265	34409	6%	
		1996	71	1473	1544	5%	
		1997	74	1891	1965	4%	
		1998	50	1677	1727	3%	
		1999	53	1878	1931	3%	
		2000	46	2298	2344	2%	
		2001	41	2517	2558	2%	
		2002	16	1050	1066	2%	
		2003	11	1679	1690	1%	
	2004	3	949	952	0%		
	2005		3	3	0%		
	2006		2	2	0%		
	2007		1	1	0%		
	P Total			16,718	150,398	167,116	10%
	T	1981			1	1	0%
1982				6	6	0%	
1983		31	114	145	21%		
1984		227	654	881	26%		
1985		330	916	1246	26%		
1986		430	1657	2087	21%		
1987		494	2514	3008	16%		
1988		634	3762	4396	14%		
1989		628	4032	4660	13%		
1990		494	3421	3915	13%		
1991		428	3822	4250	10%		
1992		548	4969	5517	10%		
1993		577	7686	8263	7%		
1994		879	11987	12866	7%		
1995		899	15323	16222	6%		
1996		27	771	798	3%		
1997	37	936	973	4%			
1998	33	983	1016	3%			
1999	10	1015	1025	1%			
2000	19	1168	1187	2%			
2001	15	1652	1667	1%			
2002	4	622	626	1%			
2003	3	869	872	0%			
2004	1	533	534	0%			
T Total			6,748	69,413	76,161	9%	
ASM Total			23,466	219,811	243,277	10%	

Table (a) (2)(i). Initial Test Results							
Test Type	Vehicle Type	Model Year	# Fail	# Pass	Total	% Fail	
MSA	P	1983		3	3	0%	
		1984		5	5	0%	
		1985		4	4	0%	
		1986		3	3	0%	
		1987		7	7	0%	
		1988		1	1	0%	
		1990		2	2	0%	
		1992		3	3	0%	
		1993	1	5	6	17%	
		1994	1	2	3	33%	
		1995		1	1	0%	
		1996		11	11	0%	
		1997	1	2	3	33%	
		2000		1	1	0%	
		2001		1	1	0%	
		2002		3	3	0%	
		2003		6	6	0%	
	2004		1	1	0%		
	P Total			3	61	64	5%
	T	1983			2	2	0%
		1984			4	4	0%
		1985			12	12	0%
		1986	2		21	23	9%
		1987	1		12	13	8%
		1988	1		24	25	4%
		1989	1		17	18	6%
		1990	1		22	23	4%
		1991			19	19	0%
		1992	1		20	21	5%
		1993	2		32	34	6%
		1994	8		35	43	19%
		1995	8		77	85	9%
		1996	7		57	64	11%
1997		8		141	149	5%	
1998		4		39	43	9%	
1999		4		200	204	2%	
2000	7		146	153	5%		
2001	1		189	190	1%		
2002	4		56	60	7%		
2003	7		190	197	4%		
2004	1		22	23	4%		
2005			1	1	0%		
T Total			68	1,338	1,406	5%	
MSA Total			71	1,399	1,470	5%	

Table (a) (2)(i). Initial Test Results							
Test Type	Vehicle Type	Model Year	# Fail	# Pass	Total	% Fail	
LMD	P	1982	1	1	2	50%	
		1983		29	29	0%	
		1984	10	154	164	6%	
		1985	14	159	173	8%	
		1986	3	57	60	5%	
		1987	7	99	106	7%	
		1988	1	2	3	33%	
		1989		19	19	0%	
		1990		31	31	0%	
		1991	2	63	65	3%	
		1992	1	45	46	2%	
		1993	1	34	35	3%	
		1994		7	7	0%	
		1995		63	63	0%	
		1996	1	94	95	1%	
		1997		8	8	0%	
		1998		4	4	0%	
		1999		18	18	0%	
		2000		14	14	0%	
		2001		19	19	0%	
	2002		9	9	0%		
	2003		30	30	0%		
	2004		5	5	0%		
		P Total		41	964	1,005	4%
		T	1983	2	4	6	33%
			1984	2	36	38	5%
			1985	7	51	58	12%
			1986	8	78	86	9%
			1987	4	51	55	7%
			1988	1	83	84	1%
			1989	1	90	91	1%
			1990	1	84	85	1%
			1991		66	66	0%
	1992			104	104	0%	
	1993			169	169	0%	
	1994		8	284	292	3%	
	1995		8	424	432	2%	
	1996		5	432	437	1%	
	1997	3	796	799	0%		
	1998		284	284	0%		
	1999	5	886	891	1%		
	2000	4	986	990	0%		
	2001		1159	1159	0%		
	2002	3	390	393	1%		
	2003	6	1325	1331	0%		
	2004	1	166	167	1%		
	T Total		69	7,948	8,017	1%	
LMD Total			110	8,912	9,022	1%	
Grand Total			79,983	970,110	1,050,093	8%	

Table (a) (2)(ii, iii). First Retest Results								
Test Type	Vehicle Type	Model Year	# Fail	# Pass	Total	% Fail	% Pass	
OBD	P	1996	548	2770	3318	17%	83%	
		1997	537	3114	3651	15%	85%	
		1998	375	2926	3301	11%	89%	
		1999	330	3119	3449	10%	90%	
		2000	345	3971	4316	8%	92%	
		2001	263	3211	3474	8%	92%	
		2002	77	979	1056	7%	93%	
		2003	55	1245	1300	4%	96%	
		2004	5	115	120	4%	96%	
	P Total			2,535	21,450	23,985	11%	89%
	T	1996	365	1564	1929	19%	81%	
		1997	304	1926	2230	14%	86%	
		1998	275	1753	2028	14%	86%	
		1999	194	1944	2138	9%	91%	
		2000	183	2463	2646	7%	93%	
		2001	219	2610	2829	8%	92%	
		2002	69	982	1051	7%	93%	
		2003	46	1495	1541	3%	97%	
		2004	9	183	192	5%	95%	
	T Total			1,664	14,920	16,584	10%	90%
OBD Total			4,199	36,370	40,569	10%	90%	

Table (a) (2)(ii, iii). First Retest Results								
Test Type	Vehicle Type	Model Year	# Fail	# Pass	Total	% Fail	% Pass	
PCTSI	P	1983		1	1	0%	100%	
		1984		1	1	0%	100%	
		1985	2	8	10	20%	80%	
		1986		5	5	0%	100%	
		1987	2	6	8	25%	75%	
		1988	1	16	17	6%	94%	
		1989	3	6	9	33%	67%	
		1990	13	22	35	37%	63%	
		1991	16	62	78	21%	79%	
		1992	17	85	102	17%	83%	
		1993	24	143	167	14%	86%	
		1994	4	125	129	3%	97%	
		1995	19	193	212	9%	91%	
		1996	3	1	4	75%	25%	
		1997	1	4	5	20%	80%	
		1998		2	2	0%	100%	
		1999		5	5	0%	100%	
		2000	2		2	100%	0%	
		2001	2	6	8	25%	75%	
		2002		4	4	0%	100%	
	2003	2	7	9	22%	78%		
	2004	1		1	100%	0%		
	P Total			110	692	802	14%	86%
	T	1983	3	4	7	43%	57%	
		1984	21	42	63	33%	67%	
		1985	26	57	83	31%	69%	
		1986	48	97	145	33%	67%	
		1987	28	92	120	23%	77%	
		1988	26	94	120	22%	78%	
		1989	21	105	126	17%	83%	
		1990	15	54	69	22%	78%	
		1991	9	41	50	18%	82%	
		1992	9	51	60	15%	85%	
1993		17	108	125	14%	86%		
1994		38	172	210	18%	82%		
1995		64	252	316	20%	80%		
1996		16	84	100	16%	84%		
1997		13	104	117	11%	89%		
1998		4	58	62	6%	94%		
1999		5	73	78	6%	94%		
2000	6	160	166	4%	96%			
2001	4	284	288	1%	99%			
2002	3	91	94	3%	97%			
2003	4	248	252	2%	98%			
2004		23	23	0%	100%			
T Total			380	2,294	2,674	14%	86%	
PCTSI Total			490	2,986	3,476	14%	86%	

Table (a) (2)(ii, iii). First Retest Results								
Test Type	Vehicle Type	Model Year	# Fail	# Pass	Total	% Fail	% Pass	
ASM	P	1981	1		1	100%	0%	
		1982	1	2	3	33%	67%	
		1983	26	42	68	38%	62%	
		1984	145	250	395	37%	63%	
		1985	207	362	569	36%	64%	
		1986	258	453	711	36%	64%	
		1987	286	558	844	34%	66%	
		1988	281	604	885	32%	68%	
		1989	288	714	1002	29%	71%	
		1990	327	861	1188	28%	72%	
		1991	346	890	1236	28%	72%	
		1992	395	1153	1548	26%	74%	
		1993	402	1285	1687	24%	76%	
		1994	328	1371	1699	19%	81%	
		1995	313	1497	1810	17%	83%	
		1996	15	32	47	32%	68%	
		1997	21	33	54	39%	61%	
		1998	9	31	40	23%	78%	
		1999	8	23	31	26%	74%	
		2000	12	24	36	33%	67%	
	2001	8	24	32	25%	75%		
	2002	4	9	13	31%	69%		
	2003	2	6	8	25%	75%		
	2004		2	2	0%	100%		
	P Total			3,683	10,226	13,909	26%	74%
	T		1982		1	1	0%	100%
			1983	3	24	27	11%	89%
			1984	45	157	202	22%	78%
			1985	68	234	302	23%	77%
			1986	87	293	380	23%	77%
			1987	93	333	426	22%	78%
			1988	126	431	557	23%	77%
			1989	94	437	531	18%	82%
1990			66	358	424	16%	84%	
1991			62	329	391	16%	84%	
1992			71	424	495	14%	86%	
1993			62	490	552	11%	89%	
1994			78	719	797	10%	90%	
1995			50	774	824	6%	94%	
1996			6	13	19	32%	68%	
1997			15	15	30	50%	50%	
1998			11	15	26	42%	58%	
1999	2	5	7	29%	71%			
2000	5	6	11	45%	55%			
2001	1	9	10	10%	90%			
2002		4	4	0%	100%			
2003		1	1	0%	100%			
2004		1	1	0%	100%			
T Total			945	5,073	6,018	16%	84%	
ASM Total			4,628	15,299	19,927	23%	77%	

Table (a) (2)(ii, iii). First Retest Results								
Test Type	Vehicle Type	Model Year	# Fail	# Pass	Total	% Fail	% Pass	
MSA	P	1994	1		1	100%	0%	
		1997	1		1	100%	0%	
	P Total			2	0	2	100%	0%
	T	1985			1	1	0%	100%
		1986			2	2	0%	100%
		1987			1	1	0%	100%
		1989	1			1	100%	0%
		1991	1			1	100%	0%
		1992			1	1	0%	100%
		1993	1	1		2	50%	50%
		1994	3	4		7	43%	57%
		1995	4	6		10	40%	60%
		1996	3	3		6	50%	50%
		1997	4	3		7	57%	43%
		1998	1	3		4	25%	75%
		1999		6		6	0%	100%
		2000	2	5		7	29%	71%
	2001		1		1	0%	100%	
	2002	2	2		4	50%	50%	
	2003	2	4		6	33%	67%	
T Total			24	43	67	36%	64%	
MSA Total			26	43	69	38%	62%	
LMD	P	1982	1		1	100%	0%	
		1983	1		1	100%	0%	
		1984	2	6		8	25%	75%
		1985	6	5		11	55%	45%
		1986		1		1	0%	100%
		1987	1	6		7	14%	86%
		1991	1	1		2	50%	50%
		1992		1		1	0%	100%
		1993		1		1	0%	100%
	1996		2		2	0%	100%	
	P Total			12	23	35	34%	66%
	T	1983	2			2	100%	0%
		1984	1	2		3	33%	67%
		1985	2	1		3	67%	33%
		1986	3	4		7	43%	57%
		1987	2	1		3	67%	33%
		1988		1		1	0%	100%
		1989		1		1	0%	100%
		1993	1			1	100%	0%
		1994	2	1		3	67%	33%
1995		1	5		6	17%	83%	
1996		2	3		5	40%	60%	
1997		3		3	0%	100%		
1999		6		6	0%	100%		
2000		3		3	0%	100%		
2002		1		1	0%	100%		
2003	1	4		5	20%	80%		
2004		1		1	0%	100%		
T Total			17	37	54	31%	69%	
LMD Total			29	60	89	33%	67%	
Grand Total			9,372	54,758	64,130	15%	85%	

Table (a) (2)(iv). Second and Later Retest Results

Test Type	Vehicle Type	Model Year	# Fail	# Pass	Total	% Fail	% Pass	
OBD	P	1996	118	293	411	29%	71%	
		1997	126	324	450	28%	72%	
		1998	78	228	306	25%	75%	
		1999	43	203	246	17%	83%	
		2000	46	206	252	18%	82%	
		2001	35	144	179	20%	80%	
		2002	8	51	59	14%	86%	
		2003	6	35	41	15%	85%	
		2004		2	2	0%	100%	
	P Total			460	1,486	1,946	24%	76%
	T	1996	71	232	303	23%	77%	
		1997	77	195	272	28%	72%	
		1998	53	167	220	24%	76%	
		1999	28	134	162	17%	83%	
		2000	22	117	139	16%	84%	
		2001	28	141	169	17%	83%	
		2002	9	47	56	16%	84%	
		2003	12	23	35	34%	66%	
		2004	1	8	9	11%	89%	
	T Total			301	1,064	1,365	22%	78%
OBD Total			761	2,550	3,311	23%	77%	

Table (a) (2)(iv). Second and Later Retest Results

Test Type	Vehicle Type	Model Year	# Fail	# Pass	Total	% Fail	% Pass	
PCTSI	P	1983		1	1	0%	100%	
		1985	2	4	6	33%	67%	
		1987	2	2	4	50%	50%	
		1988	2	1	3	67%	33%	
		1989	4	6	10	40%	60%	
		1990	7	5	12	58%	42%	
		1991	3	8	11	27%	73%	
		1992	18	14	32	56%	44%	
		1993	6	18	24	25%	75%	
		1994	6	5	11	55%	45%	
		1995	4	15	19	21%	79%	
		1996	4		4	100%	0%	
		2000	1	2	3	33%	67%	
		2001	1	1	2	50%	50%	
	P Total			60	82	142	42%	58%
	T	1983			3	3	0%	100%
		1984	12	20	32	38%	63%	
		1985	16	15	31	52%	48%	
		1986	43	39	82	52%	48%	
		1987	11	18	29	38%	62%	
		1988	10	23	33	30%	70%	
		1989	16	23	39	41%	59%	
		1990	5	14	19	26%	74%	
		1991	8	5	13	62%	38%	
		1992	3	6	9	33%	67%	
		1993	6	14	20	30%	70%	
		1994	10	28	38	26%	74%	
		1995	23	47	70	33%	67%	
		1996	9	15	24	38%	63%	
		1997	2	13	15	13%	87%	
		1998	2	3	5	40%	60%	
		1999	3	4	7	43%	57%	
		2000	3	6	9	33%	67%	
2001			4	4	0%	100%		
2002		3	3	0%	100%			
2003		4	4	0%	100%			
T Total			182	307	489	37%	63%	
PCTSI Total			242	389	631	38%	62%	

Table (a) (2)(iv). Second and Later Retest Results

Test Type	Vehicle Type	Model Year	# Fail	# Pass	Total	% Fail	% Pass	
ASM	P	1981	1	2	3	33%	67%	
		1982	3		3	100%	0%	
		1983	24	25	49	49%	51%	
		1984	68	97	165	41%	59%	
		1985	144	141	285	51%	49%	
		1986	164	154	318	52%	48%	
		1987	152	198	350	43%	57%	
		1988	145	182	327	44%	56%	
		1989	131	201	332	39%	61%	
		1990	142	216	358	40%	60%	
		1991	162	219	381	43%	57%	
		1992	241	281	522	46%	54%	
		1993	207	273	480	43%	57%	
		1994	150	218	368	41%	59%	
		1995	170	222	392	43%	57%	
		1996	13	10	23	57%	43%	
		1997	7	13	20	35%	65%	
		1998	6	7	13	46%	54%	
		1999	3	5	8	38%	63%	
		2000	7	10	17	41%	59%	
	2001	4	5	9	44%	56%		
	2002	4	5	9	44%	56%		
	2003	2	2	4	50%	50%		
	P Total			1,950	2,486	4,436	44%	56%
	T	1983	3	2	5	60%	40%	
		1984	23	28	51	45%	55%	
		1985	38	41	79	48%	52%	
		1986	52	64	116	45%	55%	
		1987	49	71	120	41%	59%	
1988		55	92	147	37%	63%		
1989		45	77	122	37%	63%		
1990		11	47	58	19%	81%		
1991		24	52	76	32%	68%		
1992		34	45	79	43%	57%		
1993		25	39	64	39%	61%		
1994		26	60	86	30%	70%		
1995		10	44	54	19%	81%		
1996		2	5	7	29%	71%		
1997	3	9	12	25%	75%			
1998	6	7	13	46%	54%			
1999	3	2	5	60%	40%			
2000	2	4	6	33%	67%			
2001		1	1	0%	100%			
T Total			411	690	1,101	37%	63%	
ASM Total			2,361	3,176	5,537	43%	57%	

Table (a) (2)(iv). Second and Later Retest Results

Test Type	Vehicle Type	Model Year	# Fail	# Pass	Total	% Fail	% Pass	
MSA	P	1994	1	1	2	50%	50%	
	P Total		1	1	2	50%	50%	
	T	1989			1	1	0%	100%
		1991			1	1	0%	100%
		1993			2	2	0%	100%
		1994	2			2	100%	0%
		1995			5	5	0%	100%
		1996			1	1	0%	100%
		1997	2	2	4	50%	50%	
		1998	1	2	3	33%	67%	
		2000			1	1	0%	100%
	2002			2	2	0%	100%	
T Total		5	17	22	23%	77%		
MSA Total			6	18	24	25%	75%	
LMD	P	1982	1		1	100%	0%	
		1983		1	1	0%	100%	
		1984	1	1	2	50%	50%	
		1985	3	3	6	50%	50%	
		1987		1	1	0%	100%	
		1991		1	1	0%	100%	
	P Total		5	7	12	42%	58%	
	T	1985			2	2	0%	100%
		1986	6	2	8	75%	25%	
		1987	1	1	2	50%	50%	
		1989			1	1	0%	100%
		1990	1		1	100%	0%	
		1994	5	1	6	83%	17%	
		1995			1	1	0%	100%
1996				3	3	0%	100%	
2003			1	1	0%	100%		
T Total		13	12	25	52%	48%		
LMD Total			18	19	37	49%	51%	
Grand Total			3,388	6,152	9,540	36%	64%	

Table (a) (2)(v). Waivers Issued			
Model Year	Passenger Car (P)	Truck (T)	Grand Total
1984	7	1	8
1985	25	1	26
1986	12	0	12
1987	5	2	7
1988	8	1	9
1989	8	2	10
1990	14	1	15
1991	11	1	12
1992	8	1	9
1993	3	0	3
1994	8	2	10
1995	6	0	6
1996	48	19	67
1997	43	6	49
1998	41	9	50
1999	41	3	44
2000	38	2	40
2001	38	1	39
2002	4	0	4
2003	3	1	4
Total	371	53	424

Table (a) (2)(vi). Vehicles with No Final Pass

Vehicle Type	Model Year	# of Initial Tests	Fail Initial Test	Pass 1st Retest	Pass 2nd+ Retest	Pass/Fail Total 2007	# That do not Pass	% No Final Pass
P	1981	6	1		1	1	0	0.0%
	1982	14	2	2		2	0	0.0%
	1983	433	88	43	27	70	18	4.2%
	1984	2576	471	257	98	355	116	4.5%
	1985	3764	688	375	148	523	165	4.4%
	1986	5128	868	459	154	613	255	5.0%
	1987	6949	1051	570	201	771	280	4.0%
	1988	8243	1124	620	183	803	321	3.9%
	1989	10568	1173	720	207	927	246	2.3%
	1990	12993	1498	883	221	1104	394	3.0%
	1991	14931	1630	953	228	1181	449	3.0%
	1992	19978	1967	1239	295	1534	433	2.2%
	1993	25193	2185	1429	291	1720	465	1.8%
	1994	29585	2121	1496	224	1720	401	1.4%
	1995	40031	2364	1690	237	1927	437	1.1%
	1996	38878	4601	2805	303	3108	1493	3.8%
	1997	50584	4829	3151	337	3488	1341	2.7%
	1998	49441	4213	2959	235	3194	1019	2.1%
	1999	63371	4545	3147	208	3355	1190	1.9%
	2000	92476	5616	3995	218	4213	1403	1.5%
2001	87537	4645	3241	150	3391	1254	1.4%	
2002	26609	1275	992	56	1048	227	0.9%	
2003	82982	1873	1258	37	1295	578	0.7%	
2004	14973	173	117	2	119	54	0.4%	
2005	13				0	0	0.0%	
2006	8				0	0	0.0%	
2007	2				0	0	0.0%	
P Total		687,266	49,001	32,401	4,061	36,462	12,539	1.8%

Table (a) (2)(vi). Vehicles with No Final Pass

Vehicle Type	Model Year	# of Initial Tests	Fail Initial Test	Pass 1st Retest	Pass 2nd+ Retest	Pass/Fail Total 2007	# That do not Pass	% No Final Pass
T	1981	1				0	0	0.0%
	1982	9	1	1		1	0	0.0%
	1983	212	39	28	5	33	6	2.8%
	1984	1449	312	201	48	249	63	4.3%
	1985	2056	447	293	58	351	96	4.7%
	1986	3349	602	396	105	501	101	3.0%
	1987	4216	637	427	90	517	120	2.8%
	1988	5889	764	526	115	641	123	2.1%
	1989	6242	769	543	102	645	124	2.0%
	1990	5010	569	412	61	473	96	1.9%
	1991	5352	492	370	58	428	64	1.2%
	1992	6865	617	476	51	527	90	1.3%
	1993	10843	727	599	55	654	73	0.7%
	1994	16881	1134	896	89	985	149	0.9%
	1995	21672	1256	1037	97	1134	122	0.6%
	1996	21596	2660	1667	256	1923	737	3.4%
	1997	29781	3074	2051	219	2270	804	2.7%
	1998	31472	2750	1829	179	2008	742	2.4%
	1999	41933	2777	2034	140	2174	603	1.4%
	2000	58964	3491	2637	128	2765	726	1.2%
2001	56928	4018	2904	146	3050	968	1.7%	
2002	19760	1319	1080	52	1132	187	0.9%	
2003	71298	2239	1752	28	1780	459	0.6%	
2004	14724	288	208	8	216	72	0.5%	
2005	5				0	0	0.0%	
2006	2				0	0	0.0%	
T Total		436,509	30,982	22,367	2,090	24,457	6,525	1.5%
Grand Total		1,050,093	79,983	54,768	6,151	60,919	19,064	1.8%

Table (a) (2)(xi, xii). Passing and Failing OBD Tests					
Vehicle Type	Model Year	Fail OBD	Pass OBD	Grand Total	% Fail
P	1996	5189	31803	36992	14%
	1997	5409	42869	48278	11%
	1998	4608	42849	47457	10%
	1999	4859	56171	61030	8%
	2000	5959	83836	89795	7%
	2001	4895	79602	84497	6%
	2002	1337	23953	25290	5%
	2003	1909	78995	80904	2%
	2004	173	13600	13773	1%
	2005		9	9	0%
2006		4	4	0%	
P Total		34,338	453,691	488,029	7%
T	1996	2945	16082	19027	15%
	1997	3284	22485	25769	13%
	1998	2975	25717	28692	10%
	1999	2898	34521	37419	8%
	2000	3499	49507	53006	7%
	2001	3947	45543	49490	8%
	2002	1292	15863	17155	8%
	2003	2016	61816	63832	3%
	2004	270	12534	12804	2%
	2005		3	3	0%
T Total		23,126	284,071	307,197	8%
Grand Total		57,464	737,762	795,226	7%

Table (a) (2) (xix, xxi, xxii). # and % Fail for MIL Commanded On

		MIL Command On Result (#)				
Vehicle Type	Model Year	MIL Not Commanded-On	No Communication	MIL Commanded-On with codes	MIL Commanded-On without codes	Total
P	1996	32110	258	4599	25	36992
	1997	43055	263	4948	12	48278
	1998	42971	232	4238	16	47457
	1999	56570	237	4200	23	61030
	2000	83916	612	5254	13	89795
	2001	79679	333	4472	13	84497
	2002	23978	91	1210	11	25290
	2003	79149	160	1591	4	80904
	2004	13603	40	129	1	13773
	2005	9				9
2006	4				4	
P Total		455,044	2,226	30,641	118	488,029
T	1996	16255	138	2631	3	19027
	1997	22668	142	2955	4	25769
	1998	25847	181	2657	7	28692
	1999	34634	413	2349	23	37419
	2000	49631	662	2700	13	53006
	2001	45631	624	3195	40	49490
	2002	15890	235	1020	10	17155
	2003	61875	706	1234	17	63832
	2004	12550	136	118		12804
2005	3				3	
T Total		284,984	3,237	18,859	117	307,197
Grand Total		740,028	5,463	49,500	235	795,226

Table (a) (2)(xix, xxi, xxii). # and % Fail for MIL Commanded On

Vehicle Type	Model Year	MIL Command On Result (%)			
		MIL Not Commanded-On	No Communication	MIL Commanded-On with codes	MIL Commanded-On without codes
P	1996	87%	1%	12%	0%
	1997	89%	1%	10%	0%
	1998	91%	0%	9%	0%
	1999	93%	0%	7%	0%
	2000	93%	1%	6%	0%
	2001	94%	0%	5%	0%
	2002	95%	0%	5%	0%
	2003	98%	0%	2%	0%
	2004	99%	0%	1%	0%
	2005	100%	0%	0%	0%
	2006	100%	0%	0%	0%
P Total		93%	0%	6%	0%
T	1996	85%	1%	14%	0%
	1997	88%	1%	11%	0%
	1998	90%	1%	9%	0%
	1999	93%	1%	6%	0%
	2000	94%	1%	5%	0%
	2001	92%	1%	6%	0%
	2002	93%	1%	6%	0%
	2003	97%	1%	2%	0%
	2004	98%	1%	1%	0%
	2005	100%	0%	0%	0%
T Total		93%	1%	6%	0%
Grand Total		93%	1%	6%	0%

Table (a) (2)(xxiii). # and % Not Ready						
Vehicle Type	Model Year	Fail Readiness	Exempted from Readiness	Pass Readiness	Total	% Fail Readiness
P	1996	2105	7076	29177	38358	5%
	1997	2775	2829	44466	50070	6%
	1998	2225	3403	43389	49017	5%
	1999	2559		60314	62873	4%
	2000	2815	551	88093	91459	3%
	2001	3281	793	82846	86920	4%
	2002	1343		25054	26397	5%
	2003	1902		80621	82523	2%
	2004	1159		13705	14864	8%
	2005	3		9	12	25%
2006	2		4	6	33%	
P Total		20,169	14,652	467,678	502,499	4%
T	1996	1224	1209	17341	19774	6%
	1997	1584	4	25208	26796	6%
	1998	1499	8	28191	29698	5%
	1999	1540		36654	38194	4%
	2000	1623		52043	53666	3%
	2001	2474		48432	50906	5%
	2002	1004		16815	17819	6%
	2003	1351		63032	64383	2%
	2004	1111		12649	13760	8%
	2005			3	3	0%
T Total		13,410	1,221	300,368	314,999	4%
Grand Total		33,579	15,873	768,046	817,498	4%

Table (a) (3 & 4). # of Tests by Station, % Fail By Station					
Station ID	Model Year	Fail	Pass	Total	% Fail
ST0000001	1983		2	2	0%
	1984	2	6	8	25%
	1985	2	18	20	10%
	1986	3	17	20	15%
	1987	7	22	29	24%
	1988	4	28	32	13%
	1989	5	40	45	11%
	1990	5	41	46	11%
	1991	3	62	65	5%
	1992	6	50	56	11%
	1993	2	89	91	2%
	1994	4	139	143	3%
	1995	4	192	196	2%
	1996	14	171	185	8%
	1997	23	221	244	9%
	1998	19	226	245	8%
	1999	14	338	352	4%
	2000	26	546	572	5%
	2001	34	469	503	7%
	2002	4	118	122	3%
2003	12	602	614	2%	
2004	1	53	54	2%	
ST0000001 Total		194	3,450	3,644	5%
ST0000015	1984	1		1	100%
	1985		1	1	0%
	1986		1	1	0%
	1987		2	2	0%
	1988	3		3	100%
	1989	1		1	100%
	1990	2	2	4	50%
	1991		4	4	0%
	1992	1	3	4	25%
	1993		1	1	0%
	1994		5	5	0%
	1995		7	7	0%
	1996	1	10	11	9%
	1997	2	8	10	20%
	1998		10	10	0%
	1999	1	23	24	4%
	2000		23	23	0%
	2001	9	63	72	13%
	2002		19	19	0%
	2003	2	62	64	3%
2004		21	21	0%	
ST0000015 Total		23	265	288	8%

Table (a) (3 & 4). # of Tests by Station, % Fail By Station					
Station ID	Model Year	Fail	Pass	Total	% Fail
ST0000017	1983	1		1	100%
	1984	2	10	12	17%
	1985	6	16	22	27%
	1986	2	18	20	10%
	1987	4	29	33	12%
	1988	7	31	38	18%
	1989	5	38	43	12%
	1990	3	43	46	7%
	1991	5	49	54	9%
	1992	3	49	52	6%
	1993	10	79	89	11%
	1994	14	129	143	10%
	1995	6	180	186	3%
	1996	17	186	203	8%
	1997	19	274	293	6%
	1998	14	272	286	5%
	1999	20	406	426	5%
	2000	25	671	696	4%
	2001	23	607	630	4%
	2002	8	185	193	4%
2003	10	742	752	1%	
2004	3	94	97	3%	
ST0000017 Total		207	4,108	4,315	5%
ST0000019	1983		1	1	0%
	1984	4	1	5	80%
	1985	1	7	8	13%
	1986	2	4	6	33%
	1987	1	8	9	11%
	1988	2	16	18	11%
	1989	4	17	21	19%
	1990		20	20	0%
	1991	5	16	21	24%
	1992	2	30	32	6%
	1993	4	44	48	8%
	1994	2	69	71	3%
	1995	5	78	83	6%
	1996	9	66	75	12%
	1997	8	86	94	9%
	1998	7	113	120	6%
	1999	9	150	159	6%
	2000	16	267	283	6%
	2001	6	153	159	4%
	2002	5	77	82	6%
2003	9	274	283	3%	
2004	1	46	47	2%	
ST0000019 Total		102	1,543	1,645	6%

Table (a) (3 & 4). # of Tests by Station, % Fail By Station					
Station ID	Model Year	Fail	Pass	Total	% Fail
ST0000020	1983	1	4	5	20%
	1984	2	9	11	18%
	1985	6	13	19	32%
	1986	6	30	36	17%
	1987	8	26	34	24%
	1988	7	56	63	11%
	1989	13	67	80	16%
	1990	12	66	78	15%
	1991	18	60	78	23%
	1992	16	93	109	15%
	1993	16	151	167	10%
	1994	32	193	225	14%
	1995	29	302	331	9%
	1996	59	246	305	19%
	1997	60	363	423	14%
	1998	40	387	427	9%
	1999	41	503	544	8%
	2000	77	711	788	10%
	2001	60	730	790	8%
	2002	25	326	351	7%
2003	43	906	949	5%	
2004	2	282	284	1%	
ST0000020 Total		573	5,524	6,097	9%
ST0000023	1983		2	2	0%
	1984	4	11	15	27%
	1985	3	10	13	23%
	1986	8	20	28	29%
	1987	14	43	57	25%
	1988	9	60	69	13%
	1989	11	72	83	13%
	1990	14	81	95	15%
	1991	16	106	122	13%
	1992	20	139	159	13%
	1993	18	164	182	10%
	1994	19	219	238	8%
	1995	27	319	346	8%
	1996	56	264	320	18%
	1997	42	376	418	10%
	1998	41	372	413	10%
	1999	44	492	536	8%
	2000	43	691	734	6%
	2001	41	723	764	5%
	2002	15	213	228	7%
2003	19	864	883	2%	
2004	3	140	143	2%	
ST0000023 Total		467	5,381	5,848	8%

Table (a) (3 & 4). # of Tests by Station, % Fail By Station					
Station ID	Model Year	Fail	Pass	Total	% Fail
ST0000034	1983		2	2	0%
	1984	3	7	10	30%
	1985	4	7	11	36%
	1986	4	17	21	19%
	1987	3	27	30	10%
	1988	6	43	49	12%
	1989	5	46	51	10%
	1990	7	34	41	17%
	1991	8	60	68	12%
	1992	11	75	86	13%
	1993	7	102	109	6%
	1994	6	138	144	4%
	1995	6	205	211	3%
	1996	21	196	217	10%
	1997	39	260	299	13%
	1998	26	289	315	8%
	1999	26	403	429	6%
	2000	40	678	718	6%
	2001	40	692	732	5%
	2002	7	215	222	3%
2003	26	844	870	3%	
2004	4	166	170	2%	
ST0000034 Total		299	4,506	4,805	6%
ST0000036	1983	1	2	3	33%
	1984	3	5	8	38%
	1985	5	7	12	42%
	1986	1	7	8	13%
	1987	1	14	15	7%
	1988	7	9	16	44%
	1989	3	16	19	16%
	1990	6	27	33	18%
	1991	1	18	19	5%
	1992	7	41	48	15%
	1993	2	42	44	5%
	1994	11	60	71	15%
	1995	8	98	106	8%
	1996	10	84	94	11%
	1997	14	125	139	10%
	1998	7	134	141	5%
	1999	10	235	245	4%
	2000	18	378	396	5%
	2001	16	351	367	4%
	2002	4	132	136	3%
2003	13	490	503	3%	
2004	3	204	207	1%	
ST0000036 Total		151	2,479	2,630	6%

Table (a) (3 & 4). # of Tests by Station, % Fail By Station					
Station ID	Model Year	Fail	Pass	Total	% Fail
ST0000060	1984		4	4	0%
	1985	1	1	2	50%
	1986		3	3	0%
	1987	2		2	100%
	1988	2	8	10	20%
	1989	1	6	7	14%
	1990	1	2	3	33%
	1991		10	10	0%
	1992	2	14	16	13%
	1993	3	25	28	11%
	1994	2	26	28	7%
	1995		27	27	0%
	1996	1	35	36	3%
	1997	6	47	53	11%
	1998		60	60	0%
	1999	1	95	96	1%
	2000	4	192	196	2%
	2001	4	195	199	2%
2002		84	84	0%	
2003	1	360	361	0%	
2004	2	179	181	1%	
ST0000060 Total		33	1,373	1,406	2%
ST0000065	1983		1	1	0%
	1984		3	3	0%
	1985	3	11	14	21%
	1986		8	8	0%
	1987	1	6	7	14%
	1988		5	5	0%
	1989		12	12	0%
	1990	2	19	21	10%
	1991	5	23	28	18%
	1992		27	27	0%
	1993	2	33	35	6%
	1994	2	34	36	6%
	1995		63	63	0%
	1996	9	63	72	13%
	1997	3	93	96	3%
	1998	9	107	116	8%
	1999	4	156	160	3%
	2000	7	243	250	3%
2001	11	279	290	4%	
2002	4	108	112	4%	
2003	2	407	409	0%	
2004	2	135	137	1%	
2007		1	1	0%	
ST0000065 Total		66	1,837	1,903	3%

Table (a) (3 & 4). # of Tests by Station, % Fail By Station					
Station ID	Model Year	Fail	Pass	Total	% Fail
ST0000107	1983	1	2	3	33%
	1984	4	9	13	31%
	1985	2	18	20	10%
	1986	9	26	35	26%
	1987	8	37	45	18%
	1988	12	50	62	19%
	1989	10	45	55	18%
	1990	14	69	83	17%
	1991	16	66	82	20%
	1992	18	97	115	16%
	1993	18	151	169	11%
	1994	23	192	215	11%
	1995	21	255	276	8%
	1996	32	208	240	13%
	1997	48	335	383	13%
	1998	44	342	386	11%
	1999	39	449	488	8%
	2000	45	603	648	7%
	2001	46	622	668	7%
	2002	15	221	236	6%
2003	18	755	773	2%	
2004	6	186	192	3%	
ST0000107 Total		449	4,738	5,187	9%
ST0000112	1983	1	2	3	33%
	1984	3	7	10	30%
	1985	4	15	19	21%
	1986	5	22	27	19%
	1987	6	32	38	16%
	1988	9	33	42	21%
	1989	5	62	67	7%
	1990	10	51	61	16%
	1991	8	75	83	10%
	1992	9	77	86	10%
	1993	12	137	149	8%
	1994	15	159	174	9%
	1995	6	209	215	3%
	1996	22	175	197	11%
	1997	23	278	301	8%
	1998	22	274	296	7%
	1999	23	337	360	6%
	2000	24	545	569	4%
	2001	33	560	593	6%
	2002	6	159	165	4%
2003	10	531	541	2%	
2004		110	110	0%	
ST0000112 Total		256	3,850	4,106	6%

Table (a) (3 & 4). # of Tests by Station, % Fail By Station					
Station ID	Model Year	Fail	Pass	Total	% Fail
ST0000116	1983		2	2	0%
	1984	3	3	6	50%
	1985	4	4	8	50%
	1986		5	5	0%
	1987	1	9	10	10%
	1988		18	18	0%
	1989	1	17	18	6%
	1990	3	20	23	13%
	1991		23	23	0%
	1992	3	24	27	11%
	1993	2	39	41	5%
	1994		47	47	0%
	1995	2	84	86	2%
	1996	8	58	66	12%
	1997	7	101	108	6%
	1998	7	103	110	6%
	1999	8	124	132	6%
	2000	11	124	135	8%
	2001	2	45	47	4%
2002	3	50	53	6%	
2003	3	159	162	2%	
2004	2	48	50	4%	
ST0000116 Total		70	1,107	1,177	6%
ST0000120	1984		1	1	0%
	1985		2	2	0%
	1986	2	8	10	20%
	1987	1	15	16	6%
	1988	1	6	7	14%
	1989		21	21	0%
	1990	2	17	19	11%
	1991	2	27	29	7%
	1992	2	32	34	6%
	1993	2	54	56	4%
	1994	5	56	61	8%
	1995	3	71	74	4%
	1996	9	65	74	12%
	1997	9	113	122	7%
	1998	10	117	127	8%
	1999	12	139	151	8%
	2000	19	286	305	6%
	2001	19	341	360	5%
	2002	6	105	111	5%
2003	14	336	350	4%	
2004	2	87	89	2%	
ST0000120 Total		120	1,899	2,019	6%

Table (a) (3 & 4). # of Tests by Station, % Fail By Station					
Station ID	Model Year	Fail	Pass	Total	% Fail
ST0000128	1983		2	2	0%
	1984	1	7	8	13%
	1985	4	9	13	31%
	1986	4	11	15	27%
	1987	4	11	15	27%
	1988	6	33	39	15%
	1989	5	19	24	21%
	1990	4	28	32	13%
	1991	6	25	31	19%
	1992	3	34	37	8%
	1993	6	58	64	9%
	1994	7	70	77	9%
	1995	6	119	125	5%
	1996	16	90	106	15%
	1997	12	131	143	8%
	1998	12	144	156	8%
	1999	18	169	187	10%
	2000	19	254	273	7%
	2001	19	246	265	7%
	2002	2	58	60	3%
2003	6	231	237	3%	
2004		26	26	0%	
ST0000128 Total		160	1,775	1,935	8%
ST0000129	1983	1	3	4	25%
	1984	4	10	14	29%
	1985	2	14	16	13%
	1986	12	17	29	41%
	1987	6	30	36	17%
	1988	8	52	60	13%
	1989	6	56	62	10%
	1990	10	64	74	14%
	1991	11	73	84	13%
	1992	7	86	93	8%
	1993	5	160	165	3%
	1994	15	181	196	8%
	1995	13	232	245	5%
	1996	21	207	228	9%
	1997	32	305	337	9%
	1998	27	340	367	7%
	1999	29	447	476	6%
	2000	30	721	751	4%
	2001	43	705	748	6%
	2002	10	210	220	5%
2003	15	827	842	2%	
2004	1	219	220	0%	
ST0000129 Total		308	4,959	5,267	6%

Table (a) (3 & 4). # of Tests by Station, % Fail By Station					
Station ID	Model Year	Fail	Pass	Total	% Fail
ST0000132	1984		5	5	0%
	1985	1	5	6	17%
	1986		13	13	0%
	1987	1	15	16	6%
	1988	3	27	30	10%
	1989	2	30	32	6%
	1990	2	35	37	5%
	1991	4	39	43	9%
	1992	4	52	56	7%
	1993	6	76	82	7%
	1994	5	102	107	5%
	1995	7	136	143	5%
	1996	4	128	132	3%
	1997	10	191	201	5%
	1998	7	210	217	3%
	1999	11	307	318	3%
	2000	18	520	538	3%
	2001	19	547	566	3%
2002	6	138	144	4%	
2003	6	709	715	1%	
2004	1	121	122	1%	
ST0000132 Total		117	3,406	3,523	3%
ST0000136	1984		4	4	0%
	1985	1	2	3	33%
	1986		5	5	0%
	1987	5	15	20	25%
	1988	2	15	17	12%
	1989	1	27	28	4%
	1990	3	12	15	20%
	1991	3	19	22	14%
	1992	6	34	40	15%
	1993		51	51	0%
	1994	1	66	67	1%
	1995	1	90	91	1%
	1996	6	75	81	7%
	1997	7	99	106	7%
	1998	3	96	99	3%
	1999	3	177	180	2%
	2000	3	130	133	2%
	2001	1	15	16	6%
2002		24	24	0%	
2003		164	164	0%	
2004		4	4	0%	
ST0000136 Total		46	1,124	1,170	4%

Table (a) (3 & 4). # of Tests by Station, % Fail By Station					
Station ID	Model Year	Fail	Pass	Total	% Fail
ST0000168	1986		1	1	0%
	1988		1	1	0%
	1990		1	1	0%
	1992		4	4	0%
	1993		2	2	0%
	1994		2	2	0%
	1995		7	7	0%
	1996		2	2	0%
	1997	1	8	9	11%
	1998	1	3	4	25%
	1999		7	7	0%
	2000		9	9	0%
	2001		2	2	0%
	2002		4	4	0%
2003		16	16	0%	
2004		7	7	0%	
ST0000168 Total		2	76	78	3%
ST0000169	1984		1	1	0%
	1992		1	1	0%
	1993	1	2	3	33%
	1994		1	1	0%
	1995	1	1	2	50%
	1996		1	1	0%
	1997	1	4	5	20%
	1998		2	2	0%
	2000	1	2	3	33%
	2001		1	1	0%
	2002	1	6	7	14%
2003		9	9	0%	
2004	2	9	11	18%	
ST0000169 Total		7	40	47	15%
ST0000171	1983		2	2	0%
	1984	4	19	23	17%
	1985	3	10	13	23%
	1986	4	24	28	14%
	1987	6	33	39	15%
	1988	5	34	39	13%
	1989	2	43	45	4%
	1990	2	60	62	3%
	1991	5	58	63	8%
	1992	9	87	96	9%
	1993	9	114	123	7%
	1994	9	135	144	6%
	1995	9	251	260	3%
	1996	17	217	234	7%
	1997	13	287	300	4%
	1998	14	346	360	4%
	1999	27	551	578	5%
	2000	37	893	930	4%
2001	37	906	943	4%	
2002	7	220	227	3%	
2003	20	1,110	1,130	2%	
2004	2	112	114	2%	
ST0000171 Total		241	5,512	5,753	4%

Table (a) (3 & 4). # of Tests by Station, % Fail By Station					
Station ID	Model Year	Fail	Pass	Total	% Fail
ST0000193	1984	2	11	13	15%
	1985	3	18	21	14%
	1986	3	20	23	13%
	1987	3	35	38	8%
	1988	5	40	45	11%
	1989	5	58	63	8%
	1990	8	49	57	14%
	1991	8	58	66	12%
	1992	13	102	115	11%
	1993	15	128	143	10%
	1994	14	178	192	7%
	1995	8	238	246	3%
	1996	31	191	222	14%
	1997	23	286	309	7%
	1998	16	303	319	5%
	1999	23	439	462	5%
	2000	38	695	733	5%
	2001	25	700	725	3%
2002	7	147	154	5%	
2003	18	946	964	2%	
2004		165	165	0%	
ST0000193 Total		268	4,807	5,075	5%
ST0000229	1984		1	1	0%
	1985		2	2	0%
	1987		5	5	0%
	1988	2	4	6	33%
	1989	2	4	6	33%
	1990	3	9	12	25%
	1991		13	13	0%
	1992	3	25	28	11%
	1993	4	29	33	12%
	1994	3	43	46	7%
	1995	1	44	45	2%
	1996	3	61	64	5%
	1997	8	101	109	7%
	1998	4	95	99	4%
	1999	6	153	159	4%
	2000	6	212	218	3%
	2001	5	218	223	2%
	2002	2	136	138	1%
2003	5	396	401	1%	
2004	3	191	194	2%	
ST0000229 Total		60	1,742	1,802	3%

Table (a) (3 & 4). # of Tests by Station, % Fail By Station					
Station ID	Model Year	Fail	Pass	Total	% Fail
ST0000315	1983		3	3	0%
	1984	6	11	17	35%
	1985	7	15	22	32%
	1986	8	16	24	33%
	1987	6	29	35	17%
	1988	12	59	71	17%
	1989	6	74	80	8%
	1990	14	69	83	17%
	1991	8	68	76	11%
	1992	6	115	121	5%
	1993	18	148	166	11%
	1994	13	192	205	6%
	1995	14	242	256	5%
	1996	39	219	258	15%
	1997	40	281	321	12%
	1998	48	273	321	15%
	1999	32	360	392	8%
	2000	35	455	490	7%
	2001	25	382	407	6%
	2002	11	132	143	8%
2003	20	419	439	5%	
2004	1	33	34	3%	
ST0000315 Total		369	3,595	3,964	9%
ST0000326	1983	1	7	8	13%
	1984	2	19	21	10%
	1985	13	18	31	42%
	1986	12	35	47	26%
	1987	10	55	65	15%
	1988	13	80	93	14%
	1989	12	77	89	13%
	1990	12	131	143	8%
	1991	13	100	113	12%
	1992	16	167	183	9%
	1993	22	231	253	9%
	1994	22	289	311	7%
	1995	33	410	443	7%
	1996	62	375	437	14%
	1997	59	517	576	10%
	1998	42	519	561	7%
	1999	57	727	784	7%
	2000	61	1,026	1,087	6%
	2001	69	994	1,063	6%
	2002	23	281	304	8%
2003	16	980	996	2%	
2004	2	135	137	1%	
ST0000326 Total		572	7,173	7,745	7%

Table (a) (3 & 4). # of Tests by Station, % Fail By Station					
Station ID	Model Year	Fail	Pass	Total	% Fail
ST0000328	1983	1	3	4	25%
	1984	9	20	29	31%
	1985	5	27	32	16%
	1986	9	40	49	18%
	1987	8	65	73	11%
	1988	21	76	97	22%
	1989	12	105	117	10%
	1990	15	90	105	14%
	1991	12	97	109	11%
	1992	14	153	167	8%
	1993	17	226	243	7%
	1994	11	270	281	4%
	1995	14	414	428	3%
	1996	48	316	364	13%
	1997	51	445	496	10%
	1998	60	441	501	12%
	1999	52	626	678	8%
	2000	70	910	980	7%
	2001	54	777	831	6%
	2002	22	231	253	9%
2003	25	911	936	3%	
2004	8	275	283	3%	
ST0000328 Total		538	6,518	7,056	8%
ST0000359	1983	1	1	2	50%
	1984	1	1	2	50%
	1985	3	1	4	75%
	1986	2		2	100%
	1987	1	7	8	13%
	1988	1	2	3	33%
	1989	1	6	7	14%
	1990	1	8	9	11%
	1991	2	6	8	25%
	1992		11	11	0%
	1993	2	21	23	9%
	1994	2	14	16	13%
	1995	1	42	43	2%
	1996	4	22	26	15%
	1997	5	36	41	12%
	1998	3	48	51	6%
	1999	7	60	67	10%
	2000	3	65	68	4%
	2001	11	195	206	5%
	2002		46	46	0%
2003	2	152	154	1%	
2004	1	61	62	2%	
ST0000359 Total		54	805	859	6%

Table (a) (3 & 4). # of Tests by Station, % Fail By Station					
Station ID	Model Year	Fail	Pass	Total	% Fail
ST0000386	1983		4	4	0%
	1984	6	23	29	21%
	1985	5	23	28	18%
	1986	12	35	47	26%
	1987	15	65	80	19%
	1988	13	80	93	14%
	1989	15	134	149	10%
	1990	15	114	129	12%
	1991	17	127	144	12%
	1992	20	202	222	9%
	1993	20	270	290	7%
	1994	30	344	374	8%
	1995	28	486	514	5%
	1996	66	432	498	13%
	1997	67	586	653	10%
	1998	51	567	618	8%
	1999	61	842	903	7%
	2000	90	1,240	1,330	7%
	2001	60	1,232	1,292	5%
	2002	22	315	337	7%
2003	51	1,402	1,453	4%	
2004	4	253	257	2%	
ST0000386 Total		668	8,776	9,444	7%
ST0000412	1983	2	2	4	50%
	1984	4	18	22	18%
	1985	6	20	26	23%
	1986	6	39	45	13%
	1987	8	38	46	17%
	1988	17	50	67	25%
	1989	11	74	85	13%
	1990	15	78	93	16%
	1991	12	88	100	12%
	1992	19	111	130	15%
	1993	20	164	184	11%
	1994	17	182	199	9%
	1995	20	261	281	7%
	1996	39	214	253	15%
	1997	50	329	379	13%
	1998	30	315	345	9%
	1999	30	364	394	8%
	2000	42	558	600	7%
	2001	40	547	587	7%
	2002	11	159	170	6%
2003	24	584	608	4%	
2004	2	91	93	2%	
ST0000412 Total		425	4,286	4,711	9%

Table (a) (3 & 4). # of Tests by Station, % Fail By Station					
Station ID	Model Year	Fail	Pass	Total	% Fail
ST0000434	1983		4	4	0%
	1984	8	16	24	33%
	1985	11	25	36	31%
	1986	12	27	39	31%
	1987	14	51	65	22%
	1988	15	65	80	19%
	1989	7	67	74	9%
	1990	11	76	87	13%
	1991	16	123	139	12%
	1992	13	139	152	9%
	1993	25	190	215	12%
	1994	25	297	322	8%
	1995	23	411	434	5%
	1996	47	431	478	10%
	1997	44	653	697	6%
	1998	58	619	677	9%
	1999	41	903	944	4%
	2000	82	1,249	1,331	6%
	2001	80	1,319	1,399	6%
	2002	19	364	383	5%
2003	47	1,575	1,622	3%	
2004	2	372	374	1%	
ST0000434 Total		600	8,976	9,576	6%
ST0000469	1982		1	1	0%
	1983		2	2	0%
	1984	3	7	10	30%
	1985	2	23	25	8%
	1986	5	33	38	13%
	1987	5	41	46	11%
	1988	6	42	48	13%
	1989	2	53	55	4%
	1990	6	51	57	11%
	1991	10	47	57	18%
	1992	5	71	76	7%
	1993	9	96	105	9%
	1994	5	158	163	3%
	1995	13	186	199	7%
	1996	14	179	193	7%
	1997	14	245	259	5%
	1998	9	239	248	4%
	1999	22	377	399	6%
	2000	21	463	484	4%
	2001	23	447	470	5%
2002	11	189	200	6%	
2003	15	526	541	3%	
2004		96	96	0%	
ST0000469 Total		200	3,572	3,772	5%

Table (a) (3 & 4). # of Tests by Station, % Fail By Station					
Station ID	Model Year	Fail	Pass	Total	% Fail
ST0000493	1983		2	2	0%
	1984	3	8	11	27%
	1985	3	3	6	50%
	1986	2	20	22	9%
	1987	5	20	25	20%
	1988	5	33	38	13%
	1989	5	39	44	11%
	1990	2	35	37	5%
	1991	2	38	40	5%
	1992	4	63	67	6%
	1993	8	79	87	9%
	1994	9	121	130	7%
	1995	9	172	181	5%
	1996	21	139	160	13%
	1997	26	216	242	11%
	1998	17	270	287	6%
	1999	31	382	413	8%
	2000	33	503	536	6%
	2001	31	476	507	6%
	2002	10	128	138	7%
2003	8	551	559	1%	
2004		50	50	0%	
ST0000493 Total		234	3,348	3,582	7%
ST0000516	1983	1	1	2	50%
	1984	6	13	19	32%
	1985	2	20	22	9%
	1986	9	46	55	16%
	1987	8	53	61	13%
	1988	7	59	66	11%
	1989	12	69	81	15%
	1990	9	84	93	10%
	1991	10	98	108	9%
	1992	16	114	130	12%
	1993	15	199	214	7%
	1994	16	235	251	6%
	1995	18	308	326	6%
	1996	31	292	323	10%
	1997	50	445	495	10%
	1998	33	495	528	6%
	1999	40	728	768	5%
	2000	75	1,110	1,185	6%
	2001	82	1,191	1,273	6%
	2002	14	228	242	6%
2003	38	1,092	1,130	3%	
2004		97	97	0%	
ST0000516 Total		492	6,977	7,469	7%

Table (a) (3 & 4). # of Tests by Station, % Fail By Station					
Station ID	Model Year	Fail	Pass	Total	% Fail
ST0000520	1983	1	2	3	33%
	1984	4	14	18	22%
	1985	6	19	25	24%
	1986	9	28	37	24%
	1987	9	32	41	22%
	1988		42	42	0%
	1989	6	44	50	12%
	1990	9	58	67	13%
	1991	4	78	82	5%
	1992	5	70	75	7%
	1993	6	103	109	6%
	1994	4	148	152	3%
	1995	9	180	189	5%
	1996	4	179	183	2%
	1997	7	242	249	3%
	1998	5	274	279	2%
	1999	9	395	404	2%
	2000	8	567	575	1%
	2001	8	585	593	1%
	2002	2	123	125	2%
2003	5	607	612	1%	
2004	3	117	120	3%	
ST0000520 Total		123	3,907	4,030	3%
ST0000525	1984	1	3	4	25%
	1985	1	4	5	20%
	1986	4	11	15	27%
	1987	3	19	22	14%
	1988	4	15	19	21%
	1989	2	24	26	8%
	1990	2	30	32	6%
	1991	2	26	28	7%
	1992	1	42	43	2%
	1993	9	64	73	12%
	1994	6	94	100	6%
	1995	9	146	155	6%
	1996	12	140	152	8%
	1997	30	215	245	12%
	1998	15	255	270	6%
	1999	29	361	390	7%
	2000	24	539	563	4%
	2001	47	485	532	9%
	2002	10	204	214	5%
	2003	14	833	847	2%
2004	2	84	86	2%	
ST0000525 Total		227	3,594	3,821	6%

Table (a) (3 & 4). # of Tests by Station, % Fail By Station					
Station ID	Model Year	Fail	Pass	Total	% Fail
ST0000549	1984		8	8	0%
	1985	4	10	14	29%
	1986	6	13	19	32%
	1987	4	22	26	15%
	1988	7	33	40	18%
	1989	4	26	30	13%
	1990	8	35	43	19%
	1991	6	56	62	10%
	1992	5	64	69	7%
	1993	5	96	101	5%
	1994	6	111	117	5%
	1995	9	173	182	5%
	1996	20	118	138	14%
	1997	12	183	195	6%
	1998	16	199	215	7%
	1999	12	311	323	4%
	2000	30	480	510	6%
	2001	25	464	489	5%
2002	4	117	121	3%	
2003	19	590	609	3%	
2004		80	80	0%	
ST0000549 Total		202	3,189	3,391	6%
ST0000557	1983		1	1	0%
	1984	5	12	17	29%
	1985	2	12	14	14%
	1986	5	11	16	31%
	1987	5	23	28	18%
	1988	3	32	35	9%
	1989	4	50	54	7%
	1990	7	35	42	17%
	1991	4	43	47	9%
	1992	2	59	61	3%
	1993	6	82	88	7%
	1994	5	124	129	4%
	1995	9	167	176	5%
	1996	17	133	150	11%
	1997	22	201	223	10%
	1998	18	197	215	8%
	1999	11	264	275	4%
	2000	17	434	451	4%
2001	18	348	366	5%	
2002	6	63	69	9%	
2003	11	406	417	3%	
2004		19	19	0%	
ST0000557 Total		177	2,716	2,893	6%

Table (a) (3 & 4). # of Tests by Station, % Fail By Station					
Station ID	Model Year	Fail	Pass	Total	% Fail
ST0000581	1983		4	4	0%
	1984	12	21	33	36%
	1985	14	29	43	33%
	1986	13	49	62	21%
	1987	18	66	84	21%
	1988	13	65	78	17%
	1989	14	99	113	12%
	1990	17	89	106	16%
	1991	16	113	129	12%
	1992	18	159	177	10%
	1993	12	191	203	6%
	1994	22	267	289	8%
	1995	26	353	379	7%
	1996	52	328	380	14%
	1997	57	455	512	11%
	1998	41	441	482	9%
	1999	56	623	679	8%
	2000	55	814	869	6%
	2001	48	704	752	6%
	2002	17	259	276	6%
2003	28	793	821	3%	
2004	2	259	261	1%	
ST0000581 Total		551	6,181	6,732	8%
ST0000616	1983	1	1	2	50%
	1984		5	5	0%
	1985	2	8	10	20%
	1986	2	13	15	13%
	1987	5	17	22	23%
	1988	2	18	20	10%
	1989	2	36	38	5%
	1990	5	30	35	14%
	1991	6	37	43	14%
	1992	6	57	63	10%
	1993	7	98	105	7%
	1994	11	113	124	9%
	1995	6	169	175	3%
	1996	22	175	197	11%
	1997	25	257	282	9%
	1998	30	319	349	9%
	1999	21	381	402	5%
	2000	32	620	652	5%
	2001	47	592	639	7%
	2002	22	178	200	11%
2003	24	687	711	3%	
2004	1	64	65	2%	
ST0000616 Total		279	3,875	4,154	7%

Table (a) (3 & 4). # of Tests by Station, % Fail By Station					
Station ID	Model Year	Fail	Pass	Total	% Fail
ST0000618	1984		2	2	0%
	1985	4	7	11	36%
	1986		9	9	0%
	1987	3	13	16	19%
	1988	4	23	27	15%
	1989	4	30	34	12%
	1990	3	37	40	8%
	1991	3	41	44	7%
	1992	5	48	53	9%
	1993	11	71	82	13%
	1994	7	107	114	6%
	1995	8	135	143	6%
	1996	13	146	159	8%
	1997	20	180	200	10%
	1998	25	209	234	11%
	1999	26	267	293	9%
	2000	31	393	424	7%
	2001	24	395	419	6%
2002	11	100	111	10%	
2003	12	433	445	3%	
2004	1	34	35	3%	
ST0000618 Total		215	2,680	2,895	7%
ST0000621	1983		1	1	0%
	1984	1	5	6	17%
	1985	8	8	16	50%
	1986	3	14	17	18%
	1987	3	21	24	13%
	1988	5	32	37	14%
	1989	3	56	59	5%
	1990	11	54	65	17%
	1991	5	51	56	9%
	1992	15	71	86	17%
	1993	8	97	105	8%
	1994	9	152	161	6%
	1995	16	180	196	8%
	1996	13	183	196	7%
	1997	21	209	230	9%
	1998	26	249	275	9%
	1999	27	276	303	9%
	2000	24	372	396	6%
2001	30	326	356	8%	
2002	6	81	87	7%	
2003	4	355	359	1%	
2004	1	19	20	5%	
ST0000621 Total		239	2,812	3,051	8%

Table (a) (3 & 4). # of Tests by Station, % Fail By Station					
Station ID	Model Year	Fail	Pass	Total	% Fail
ST0000648	1983		1	1	0%
	1984	1	7	8	13%
	1985	4	11	15	27%
	1986	5	16	21	24%
	1987	5	14	19	26%
	1988	3	29	32	9%
	1989	8	46	54	15%
	1990	6	39	45	13%
	1991	4	41	45	9%
	1992	6	62	68	9%
	1993	4	81	85	5%
	1994	6	109	115	5%
	1995	4	161	165	2%
	1996	11	125	136	8%
	1997	16	197	213	8%
	1998	10	201	211	5%
	1999	17	304	321	5%
	2000	14	411	425	3%
	2001	18	394	412	4%
	2002	2	70	72	3%
2003	6	408	414	1%	
2004		24	24	0%	
ST0000648 Total		150	2,751	2,901	5%
ST0000697	1983	1		1	100%
	1984	5	2	7	71%
	1985	4	10	14	29%
	1986	5	9	14	36%
	1987	9	18	27	33%
	1988	6	25	31	19%
	1989	10	34	44	23%
	1990	6	37	43	14%
	1991	6	53	59	10%
	1992	13	66	79	16%
	1993	11	108	119	9%
	1994	7	114	121	6%
	1995	7	170	177	4%
	1996	29	204	233	12%
	1997	23	230	253	9%
	1998	21	222	243	9%
	1999	23	285	308	7%
	2000	21	393	414	5%
	2001	29	408	437	7%
	2002	7	122	129	5%
2003	6	378	384	2%	
2004	2	75	77	3%	
ST0000697 Total		251	2,963	3,214	8%

Table (a) (3 & 4). # of Tests by Station, % Fail By Station					
Station ID	Model Year	Fail	Pass	Total	% Fail
ST0000711	1985		1	1	0%
	1986	1	1	2	50%
	1987		4	4	0%
	1988	2	4	6	33%
	1989		6	6	0%
	1990		3	3	0%
	1991		5	5	0%
	1992	2	6	8	25%
	1993		12	12	0%
	1994		11	11	0%
	1995	2	16	18	11%
	1996		24	24	0%
	1997	1	20	21	5%
	1998		18	18	0%
	1999		32	32	0%
	2000	2	17	19	11%
	2001		7	7	0%
2002		11	11	0%	
2003		38	38	0%	
2004		9	9	0%	
ST0000711 Total		10	245	255	4%
ST0000718	1983		2	2	0%
	1984	1	6	7	14%
	1985	2	9	11	18%
	1986	1	13	14	7%
	1987	2	25	27	7%
	1988	3	24	27	11%
	1989	8	47	55	15%
	1990	9	45	54	17%
	1991	8	61	69	12%
	1992	8	65	73	11%
	1993	7	114	121	6%
	1994	8	157	165	5%
	1995	17	179	196	9%
	1996	23	127	150	15%
	1997	39	174	213	18%
	1998	35	170	205	17%
	1999	29	227	256	11%
	2000	24	327	351	7%
	2001	22	250	272	8%
	2002	8	88	96	8%
2003	9	249	258	3%	
2004	1	49	50	2%	
2005		1	1	0%	
2006		1	1	0%	
2007		1	1	0%	
ST0000718 Total		264	2,411	2,675	10%

Table (a) (3 & 4). # of Tests by Station, % Fail By Station					
Station ID	Model Year	Fail	Pass	Total	% Fail
ST0000725	1984	4	11	15	27%
	1985	5	9	14	36%
	1986	7	14	21	33%
	1987	6	31	37	16%
	1988	4	48	52	8%
	1989	5	56	61	8%
	1990	10	44	54	19%
	1991	10	88	98	10%
	1992	12	87	99	12%
	1993	14	132	146	10%
	1994	12	157	169	7%
	1995	13	193	206	6%
	1996	32	196	228	14%
	1997	23	245	268	9%
	1998	28	204	232	12%
	1999	25	293	318	8%
	2000	30	425	455	7%
2001	20	341	361	6%	
2002	7	95	102	7%	
2003	7	350	357	2%	
2004	1	54	55	2%	
ST0000725 Total		275	3,073	3,348	8%
ST0000730	1983	2	1	3	67%
	1984	7	21	28	25%
	1985	7	18	25	28%
	1986	19	43	62	31%
	1987	17	63	80	21%
	1988	29	90	119	24%
	1989	18	117	135	13%
	1990	30	148	178	17%
	1991	32	204	236	14%
	1992	26	239	265	10%
	1993	26	331	357	7%
	1994	29	421	450	6%
	1995	34	563	597	6%
	1996	104	443	547	19%
	1997	102	569	671	15%
	1998	110	575	685	16%
	1999	97	743	840	12%
	2000	108	909	1,017	11%
2001	74	842	916	8%	
2002	33	379	412	8%	
2003	32	678	710	5%	
2004	7	166	173	4%	
2005		4	4	0%	
2006		2	2	0%	
ST0000730 Total		943	7,569	8,512	11%

Table (a) (3 & 4). # of Tests by Station, % Fail By Station					
Station ID	Model Year	Fail	Pass	Total	% Fail
ST0000776	1984	2	13	15	13%
	1985	6	21	27	22%
	1986	6	31	37	16%
	1987	13	38	51	25%
	1988	12	66	78	15%
	1989	9	85	94	10%
	1990	12	92	104	12%
	1991	9	80	89	10%
	1992	17	140	157	11%
	1993	13	189	202	6%
	1994	18	249	267	7%
	1995	20	344	364	5%
	1996	46	285	331	14%
	1997	36	429	465	8%
	1998	47	431	478	10%
	1999	34	576	610	6%
	2000	50	863	913	5%
2001	54	914	968	6%	
2002	13	207	220	6%	
2003	17	904	921	2%	
2004	1	126	127	1%	
ST0000776 Total		435	6,083	6,518	7%
ST0000779	1983		1	1	0%
	1984	4	11	15	27%
	1985	1	15	16	6%
	1986	3	18	21	14%
	1987	8	14	22	36%
	1988	3	28	31	10%
	1989	6	26	32	19%
	1990	5	37	42	12%
	1991	4	36	40	10%
	1992	4	53	57	7%
	1993	8	57	65	12%
	1994	8	104	112	7%
	1995	5	162	167	3%
	1996	22	139	161	14%
	1997	31	167	198	16%
	1998	11	189	200	6%
	1999	18	256	274	7%
2000	30	444	474	6%	
2001	29	378	407	7%	
2002	10	83	93	11%	
2003	9	357	366	2%	
2004	2	60	62	3%	
ST0000779 Total		221	2,635	2,856	8%

Table (a) (3 & 4). # of Tests by Station, % Fail By Station					
Station ID	Model Year	Fail	Pass	Total	% Fail
ST0000790	1983		1	1	0%
	1984	5	20	25	20%
	1985	12	24	36	33%
	1986	7	33	40	18%
	1987	6	48	54	11%
	1988	6	74	80	8%
	1989	11	99	110	10%
	1990	6	103	109	6%
	1991	8	90	98	8%
	1992	11	107	118	9%
	1993	14	184	198	7%
	1994	19	230	249	8%
	1995	21	326	347	6%
	1996	49	259	308	16%
	1997	49	347	396	12%
	1998	40	337	377	11%
	1999	48	491	539	9%
	2000	56	776	832	7%
2001	50	676	726	7%	
2002	7	189	196	4%	
2003	13	692	705	2%	
2004	2	96	98	2%	
ST0000790 Total		440	5,202	5,642	8%
ST0000809	1983		1	1	0%
	1984	1	8	9	11%
	1985	4	6	10	40%
	1986	5	12	17	29%
	1987	8	22	30	27%
	1988	3	34	37	8%
	1989	6	35	41	15%
	1990	12	35	47	26%
	1991	8	37	45	18%
	1992	5	54	59	8%
	1993	6	94	100	6%
	1994	9	131	140	6%
	1995	12	139	151	8%
	1996	11	143	154	7%
	1997	10	182	192	5%
	1998	17	210	227	7%
	1999	14	256	270	5%
	2000	26	397	423	6%
2001	19	369	388	5%	
2002	3	124	127	2%	
2003	5	356	361	1%	
2004		65	65	0%	
ST0000809 Total		184	2,710	2,894	6%

Table (a) (3 & 4). # of Tests by Station, % Fail By Station					
Station ID	Model Year	Fail	Pass	Total	% Fail
ST0000825	1983	2	1	3	67%
	1984	1	7	8	13%
	1985	1	10	11	9%
	1986	8	17	25	32%
	1987	4	25	29	14%
	1988	4	34	38	11%
	1989	9	38	47	19%
	1990	12	50	62	19%
	1991	11	63	74	15%
	1992	10	88	98	10%
	1993	8	117	125	6%
	1994	9	141	150	6%
	1995	7	203	210	3%
	1996	15	235	250	6%
	1997	32	303	335	10%
	1998	19	309	328	6%
	1999	31	446	477	6%
	2000	38	685	723	5%
	2001	39	633	672	6%
	2002	11	178	189	6%
2003	13	675	688	2%	
2004		104	104	0%	
ST0000825 Total		284	4,362	4,646	6%
ST0000915	1984		1	1	0%
	1985		1	1	0%
	1986		1	1	0%
	1987		4	4	0%
	1988		3	3	0%
	1989		4	4	0%
	1990		4	4	0%
	1991		2	2	0%
	1992	2		2	100%
	1993	1	6	7	14%
	1994		11	11	0%
	1995	1	11	12	8%
	1996	1	10	11	9%
	1997	1	21	22	5%
	1998	1	17	18	6%
	1999	1	18	19	5%
	2000		15	15	0%
	2001	4	48	52	8%
	2002	1	9	10	10%
	2003	1	44	45	2%
2004		24	24	0%	
ST0000915 Total		14	254	268	5%

Table (a) (3 & 4). # of Tests by Station, % Fail By Station					
Station ID	Model Year	Fail	Pass	Total	% Fail
ST0000951	1983		2	2	0%
	1984	1	3	4	25%
	1985	2	8	10	20%
	1986	6	6	12	50%
	1987	3	13	16	19%
	1988	4	25	29	14%
	1989	4	28	32	13%
	1990	3	30	33	9%
	1991	6	30	36	17%
	1992	6	45	51	12%
	1993	6	56	62	10%
	1994	8	68	76	11%
	1995	6	114	120	5%
	1996	13	87	100	13%
	1997	9	154	163	6%
	1998	9	167	176	5%
	1999	10	258	268	4%
	2000	14	345	359	4%
	2001	14	332	346	4%
	2002	3	174	177	2%
2003	9	347	356	3%	
2004	3	286	289	1%	
ST0000951 Total		139	2,578	2,717	5%
ST0000963	1983		2	2	0%
	1984	3	8	11	27%
	1985	2	5	7	29%
	1986	3	18	21	14%
	1987	6	24	30	20%
	1988	5	29	34	15%
	1989	6	44	50	12%
	1990	5	49	54	9%
	1991	6	43	49	12%
	1992	3	61	64	5%
	1993	6	92	98	6%
	1994	6	126	132	5%
	1995	10	203	213	5%
	1996	20	174	194	10%
	1997	24	232	256	9%
	1998	20	276	296	7%
	1999	33	334	367	9%
	2000	30	560	590	5%
	2001	35	496	531	7%
	2002	9	215	224	4%
2003	15	682	697	2%	
2004		182	182	0%	
ST0000963 Total		247	3,855	4,102	6%

Table (a) (3 & 4). # of Tests by Station, % Fail By Station					
Station ID	Model Year	Fail	Pass	Total	% Fail
ST0000969	1983		2	2	0%
	1984	4	4	8	50%
	1985	3	7	10	30%
	1986	3	6	9	33%
	1987	3	21	24	13%
	1988	2	26	28	7%
	1989	7	23	30	23%
	1990	6	18	24	25%
	1991	6	23	29	21%
	1992	5	42	47	11%
	1993	7	33	40	18%
	1994	5	54	59	8%
	1995	12	94	106	11%
	1996	8	65	73	11%
	1997	7	99	106	7%
	1998	8	117	125	6%
	1999	9	147	156	6%
	2000	15	187	202	7%
	2001	12	177	189	6%
2002	3	54	57	5%	
2003	9	162	171	5%	
2004		25	25	0%	
ST0000969 Total		134	1,386	1,520	9%
ST0000971	1984	2	1	3	67%
	1985	1	7	8	13%
	1986	3	10	13	23%
	1987	6	11	17	35%
	1988	2	12	14	14%
	1989	7	32	39	18%
	1990	2	23	25	8%
	1991	1	27	28	4%
	1992	5	51	56	9%
	1993	4	66	70	6%
	1994	7	83	90	8%
	1995	5	122	127	4%
	1996	14	105	119	12%
	1997	18	170	188	10%
	1998	13	187	200	7%
	1999	14	241	255	5%
	2000	22	389	411	5%
	2001	25	356	381	7%
	2002	6	83	89	7%
2003	9	400	409	2%	
2004		22	22	0%	
ST0000971 Total		166	2,398	2,564	6%

Table (a) (3 & 4). # of Tests by Station, % Fail By Station					
Station ID	Model Year	Fail	Pass	Total	% Fail
ST0000972	1983		2	2	0%
	1984	1	11	12	8%
	1985	6	22	28	21%
	1986	4	15	19	21%
	1987	8	37	45	18%
	1988	10	41	51	20%
	1989	8	52	60	13%
	1990	6	56	62	10%
	1991	10	74	84	12%
	1992	13	76	89	15%
	1993	11	100	111	10%
	1994	8	142	150	5%
	1995	13	189	202	6%
	1996	19	177	196	10%
	1997	32	256	288	11%
	1998	26	260	286	9%
	1999	35	306	341	10%
	2000	26	487	513	5%
	2001	34	397	431	8%
	2002	5	184	189	3%
2003	11	494	505	2%	
2004	3	178	181	2%	
ST0000972 Total		289	3,556	3,845	8%
ST0000976	1983		3	3	0%
	1984	5	14	19	26%
	1985	2	17	19	11%
	1986	5	23	28	18%
	1987	7	29	36	19%
	1988	10	52	62	16%
	1989	5	56	61	8%
	1990	7	62	69	10%
	1991	8	66	74	11%
	1992	12	106	118	10%
	1993	7	123	130	5%
	1994	20	180	200	10%
	1995	19	274	293	6%
	1996	36	235	271	13%
	1997	43	318	361	12%
	1998	36	327	363	10%
	1999	39	463	502	8%
	2000	42	629	671	6%
	2001	46	764	810	6%
	2002	17	295	312	5%
2003	19	786	805	2%	
2004	4	229	233	2%	
ST0000976 Total		389	5,051	5,440	7%

Table (a) (3 & 4). # of Tests by Station, % Fail By Station					
Station ID	Model Year	Fail	Pass	Total	% Fail
ST0000986	1983	2	1	3	67%
	1984	5	10	15	33%
	1985	3	11	14	21%
	1986	4	21	25	16%
	1987	3	21	24	13%
	1988	6	35	41	15%
	1989	10	40	50	20%
	1990	2	44	46	4%
	1991	5	48	53	9%
	1992	6	78	84	7%
	1993	10	103	113	9%
	1994	11	140	151	7%
	1995	9	189	198	5%
	1996	18	158	176	10%
	1997	21	225	246	9%
	1998	23	249	272	8%
	1999	20	312	332	6%
	2000	28	486	514	5%
	2001	25	428	453	6%
	2002	4	135	139	3%
2003	9	538	547	2%	
2004		93	93	0%	
ST0000986 Total		224	3,365	3,589	6%
ST0000994	1983		1	1	0%
	1984	2	10	12	17%
	1985	7	16	23	30%
	1986	6	21	27	22%
	1987	5	48	53	9%
	1988	12	48	60	20%
	1989	5	57	62	8%
	1990	5	60	65	8%
	1991	8	73	81	10%
	1992	9	110	119	8%
	1993	12	127	139	9%
	1994	13	167	180	7%
	1995	18	273	291	6%
	1996	32	250	282	11%
	1997	40	338	378	11%
	1998	34	372	406	8%
	1999	37	450	487	8%
	2000	58	743	801	7%
	2001	60	763	823	7%
	2002	9	178	187	5%
2003	29	741	770	4%	
2004	4	64	68	6%	
2005		1	1	0%	
ST0000994 Total		405	4,911	5,316	8%

Table (a) (3 & 4). # of Tests by Station, % Fail By Station					
Station ID	Model Year	Fail	Pass	Total	% Fail
ST0001051	1983		3	3	0%
	1984	5	8	13	38%
	1985	3	10	13	23%
	1986	2	18	20	10%
	1987	1	24	25	4%
	1988	4	25	29	14%
	1989	4	27	31	13%
	1990	7	41	48	15%
	1991	7	34	41	17%
	1992	9	60	69	13%
	1993	11	69	80	14%
	1994	13	116	129	10%
	1995	7	157	164	4%
	1996	21	148	169	12%
	1997	20	204	224	9%
	1998	15	228	243	6%
	1999	23	306	329	7%
	2000	23	448	471	5%
	2001	23	473	496	5%
	2002	12	150	162	7%
2003	15	509	524	3%	
2004	2	81	83	2%	
ST0001051 Total		227	3,139	3,366	7%
ST0001056	1984	6	14	20	30%
	1985	12	14	26	46%
	1986	15	48	63	24%
	1987	9	49	58	16%
	1988	16	75	91	18%
	1989	11	78	89	12%
	1990	18	87	105	17%
	1991	11	89	100	11%
	1992	12	143	155	8%
	1993	9	180	189	5%
	1994	10	236	246	4%
	1995	20	351	371	5%
	1996	37	279	316	12%
	1997	38	465	503	8%
	1998	47	474	521	9%
	1999	37	595	632	6%
	2000	43	774	817	5%
	2001	63	758	821	8%
	2002	14	178	192	7%
	2003	23	828	851	3%
2004	1	92	93	1%	
ST0001056 Total		452	5,807	6,259	7%

Table (a) (3 & 4). # of Tests by Station, % Fail By Station					
Station ID	Model Year	Fail	Pass	Total	% Fail
ST0001066	1983	1	1	2	50%
	1984	7	4	11	64%
	1985	6	9	15	40%
	1986	6	20	26	23%
	1987	5	14	19	26%
	1988	6	37	43	14%
	1989	10	38	48	21%
	1990	2	44	46	4%
	1991	3	28	31	10%
	1992	6	49	55	11%
	1993	12	80	92	13%
	1994	7	88	95	7%
	1995	10	114	124	8%
	1996	17	102	119	14%
	1997	20	169	189	11%
	1998	10	150	160	6%
	1999	21	232	253	8%
	2000	13	283	296	4%
	2001	17	310	327	5%
	2002	6	77	83	7%
2003	6	329	335	2%	
2004	3	56	59	5%	
ST0001066 Total		194	2,234	2,428	8%
ST0001095	1983	1	4	5	20%
	1984	1	9	10	10%
	1985	4	13	17	24%
	1986	4	32	36	11%
	1987	16	25	41	39%
	1988	4	37	41	10%
	1989	4	50	54	7%
	1990	8	73	81	10%
	1991	11	75	86	13%
	1992	20	102	122	16%
	1993	12	139	151	8%
	1994	17	205	222	8%
	1995	30	257	287	10%
	1996	35	224	259	14%
	1997	42	323	365	12%
	1998	32	345	377	8%
	1999	30	468	498	6%
	2000	34	602	636	5%
	2001	38	576	614	6%
	2002	12	161	173	7%
2003	20	495	515	4%	
2004	1	111	112	1%	
ST0001095 Total		376	4,326	4,702	8%

Table (a) (3 & 4). # of Tests by Station, % Fail By Station					
Station ID	Model Year	Fail	Pass	Total	% Fail
ST0001131	1984		1	1	0%
	1985		4	4	0%
	1986	2	4	6	33%
	1987	4	7	11	36%
	1988	3	8	11	27%
	1989	2	10	12	17%
	1990	4	9	13	31%
	1991	4	20	24	17%
	1992	4	32	36	11%
	1993	3	43	46	7%
	1994	10	47	57	18%
	1995	4	64	68	6%
	1996	14	77	91	15%
	1997	7	108	115	6%
	1998	6	153	159	4%
	1999	11	183	194	6%
	2000	14	232	246	6%
	2001	25	279	304	8%
2002	5	69	74	7%	
2003	9	217	226	4%	
2004		58	58	0%	
ST0001131 Total		131	1,625	1,756	7%
ST0001193	1983		1	1	0%
	1984	4	30	34	12%
	1985	6	37	43	14%
	1986	15	54	69	22%
	1987	13	72	85	15%
	1988	13	85	98	13%
	1989	14	106	120	12%
	1990	16	122	138	12%
	1991	17	151	168	10%
	1992	22	192	214	10%
	1993	24	268	292	8%
	1994	18	322	340	5%
	1995	24	505	529	5%
	1996	61	406	467	13%
	1997	83	469	552	15%
	1998	64	476	540	12%
	1999	48	605	653	7%
	2000	76	831	907	8%
2001	55	692	747	7%	
2002	25	248	273	9%	
2003	30	727	757	4%	
2004	1	103	104	1%	
ST0001193 Total		629	6,502	7,131	9%

Table (a) (3 & 4). # of Tests by Station, % Fail By Station					
Station ID	Model Year	Fail	Pass	Total	% Fail
ST0001214	1986		1	1	0%
	1987		2	2	0%
	1988	1	2	3	33%
	1989	1	3	4	25%
	1990		4	4	0%
	1991	1	7	8	13%
	1992		4	4	0%
	1993	2	5	7	29%
	1994		10	10	0%
	1995	1	14	15	7%
	1996	6	32	38	16%
	1997	1	35	36	3%
	1998	5	35	40	13%
	1999	6	47	53	11%
	2000	3	53	56	5%
	2001	3	11	14	21%
2002		16	16	0%	
2003	2	50	52	4%	
2004		1	1	0%	
ST0001214 Total		32	332	364	9%
ST0001216	1983		2	2	0%
	1984	5	17	22	23%
	1985	8	29	37	22%
	1986	9	23	32	28%
	1987	16	54	70	23%
	1988	10	80	90	11%
	1989	18	108	126	14%
	1990	18	112	130	14%
	1991	17	130	147	12%
	1992	23	177	200	12%
	1993	29	232	261	11%
	1994	31	315	346	9%
	1995	34	480	514	7%
	1996	67	383	450	15%
	1997	78	579	657	12%
	1998	75	593	668	11%
	1999	67	845	912	7%
	2000	85	1228	1313	6%
2001	80	1113	1193	7%	
2002	30	375	405	7%	
2003	36	1199	1235	3%	
2004	2	151	153	1%	
ST0001216 Total		738	8,225	8,963	8%

Table (a) (3 & 4). # of Tests by Station, % Fail By Station					
Station ID	Model Year	Fail	Pass	Total	% Fail
ST0001220	1984	2	3	5	40%
	1985	1	5	6	17%
	1986	2	6	8	25%
	1987	1	4	5	20%
	1988	1	9	10	10%
	1989	4	12	16	25%
	1990	3	12	15	20%
	1991	2	17	19	11%
	1992	4	13	17	24%
	1993	4	39	43	9%
	1994		41	41	0%
	1995	3	62	65	5%
	1996	9	51	60	15%
	1997	12	91	103	12%
	1998	7	91	98	7%
	1999	12	95	107	11%
	2000	25	240	265	9%
	2001	31	430	461	7%
2002	2	89	91	2%	
2003	12	345	357	3%	
2004	1	44	45	2%	
ST0001220 Total		138	1,699	1,837	8%
ST0001235	1984	2	4	6	33%
	1985	2	7	9	22%
	1986	3	9	12	25%
	1987	4	13	17	24%
	1988	5	16	21	24%
	1989	2	20	22	9%
	1990	1	32	33	3%
	1991	4	34	38	11%
	1992	1	44	45	2%
	1993	2	60	62	3%
	1994	5	110	115	4%
	1995	7	135	142	5%
	1996	23	139	162	14%
	1997	20	222	242	8%
	1998	12	268	280	4%
	1999	28	388	416	7%
	2000	29	571	600	5%
	2001	38	630	668	6%
2002	12	247	259	5%	
2003	24	852	876	3%	
2004	1	72	73	1%	
ST0001235 Total		225	3,873	4,098	5%

Table (a) (3 & 4). # of Tests by Station, % Fail By Station					
Station ID	Model Year	Fail	Pass	Total	% Fail
ST0001253	1983	1	2	3	33%
	1984	4	8	12	33%
	1985	2	11	13	15%
	1986	13	24	37	35%
	1987	7	41	48	15%
	1988	7	39	46	15%
	1989	12	58	70	17%
	1990	17	69	86	20%
	1991	16	93	109	15%
	1992	22	134	156	14%
	1993	23	201	224	10%
	1994	24	227	251	10%
	1995	29	365	394	7%
	1996	58	301	359	16%
	1997	53	422	475	11%
	1998	52	421	473	11%
	1999	46	569	615	7%
	2000	60	772	832	7%
	2001	52	746	798	7%
	2002	19	238	257	7%
2003	15	700	715	2%	
2004	4	82	86	5%	
2005		1	1	0%	
ST0001253 Total		536	5,524	6,060	9%
ST0001264	1983	1	1	2	50%
	1984	4	12	16	25%
	1985	9	16	25	36%
	1986	7	35	42	17%
	1987	7	28	35	20%
	1988	5	45	50	10%
	1989	4	56	60	7%
	1990	4	60	64	6%
	1991	10	77	87	11%
	1992	9	97	106	8%
	1993	9	126	135	7%
	1994	11	149	160	7%
	1995	13	218	231	6%
	1996	20	208	228	9%
	1997	22	270	292	8%
	1998	28	283	311	9%
	1999	21	384	405	5%
	2000	39	565	604	6%
	2001	28	529	557	5%
	2002	7	174	181	4%
2003	13	623	636	2%	
2004	2	146	148	1%	
ST0001264 Total		273	4,102	4,375	6%

Table (a) (3 & 4). # of Tests by Station, % Fail By Station					
Station ID	Model Year	Fail	Pass	Total	% Fail
ST0001267	1983		1	1	0%
	1984	1	14	15	7%
	1985	6	9	15	40%
	1986	7	10	17	41%
	1987	5	25	30	17%
	1988	3	25	28	11%
	1989	3	41	44	7%
	1990	5	37	42	12%
	1991	5	43	48	10%
	1992	7	67	74	9%
	1993	5	71	76	7%
	1994	6	88	94	6%
	1995	9	140	149	6%
	1996	9	118	127	7%
	1997	14	206	220	6%
	1998	21	158	179	12%
	1999	16	258	274	6%
	2000	22	335	357	6%
	2001	16	351	367	4%
	2002	7	95	102	7%
2003	5	360	365	1%	
2004	1	45	46	2%	
ST0001267 Total		173	2,497	2,670	6%
ST0001270	1983		2	2	0%
	1984	2	5	7	29%
	1985	3	9	12	25%
	1986	3	13	16	19%
	1987	3	25	28	11%
	1988	4	31	35	11%
	1989	11	44	55	20%
	1990	8	64	72	11%
	1991	2	63	65	3%
	1992	5	74	79	6%
	1993	8	88	96	8%
	1994	13	124	137	9%
	1995	10	171	181	6%
	1996	19	172	191	10%
	1997	25	195	220	11%
	1998	15	191	206	7%
	1999	14	288	302	5%
	2000	16	376	392	4%
	2001	22	381	403	5%
	2002	6	95	101	6%
2003	7	323	330	2%	
2004	1	41	42	2%	
2006		1	1	0%	
ST0001270 Total		197	2,776	2,973	7%

Table (a) (3 & 4). # of Tests by Station, % Fail By Station					
Station ID	Model Year	Fail	Pass	Total	% Fail
ST0001274	1983		2	2	0%
	1984	2	15	17	12%
	1985	5	14	19	26%
	1986	6	31	37	16%
	1987	9	29	38	24%
	1988	10	62	72	14%
	1989	9	68	77	12%
	1990	7	68	75	9%
	1991	6	60	66	9%
	1992	5	78	83	6%
	1993	8	111	119	7%
	1994	9	152	161	6%
	1995	17	225	242	7%
	1996	15	202	217	7%
	1997	24	250	274	9%
	1998	19	269	288	7%
	1999	29	362	391	7%
	2000	30	528	558	5%
	2001	31	497	528	6%
2002	11	105	116	9%	
2003	23	533	556	4%	
2004		32	32	0%	
ST0001274 Total		275	3,693	3,968	7%
ST0001284	1984		9	9	0%
	1985	6	9	15	40%
	1986	3	20	23	13%
	1987	7	30	37	19%
	1988	4	40	44	9%
	1989	6	57	63	10%
	1990	8	57	65	12%
	1991	11	50	61	18%
	1992	7	81	88	8%
	1993	6	98	104	6%
	1994	8	154	162	5%
	1995	14	239	253	6%
	1996	22	224	246	9%
	1997	27	316	343	8%
	1998	32	369	401	8%
	1999	40	511	551	7%
	2000	50	777	827	6%
	2001	46	765	811	6%
	2002	10	175	185	5%
2003	25	864	889	3%	
2004		59	59	0%	
ST0001284 Total		332	4,904	5,236	6%

Table (a) (3 & 4). # of Tests by Station, % Fail By Station					
Station ID	Model Year	Fail	Pass	Total	% Fail
ST0001294	1984		1	1	0%
	1985		3	3	0%
	1986		1	1	0%
	1987		9	9	0%
	1988	1	2	3	33%
	1989	1	7	8	13%
	1990	3	11	14	21%
	1991		15	15	0%
	1992	2	13	15	13%
	1993	6	28	34	18%
	1994	3	33	36	8%
	1995	3	47	50	6%
	1996	12	61	73	16%
	1997	16	78	94	17%
	1998	3	82	85	4%
	1999	10	135	145	7%
	2000	13	227	240	5%
2001	12	232	244	5%	
2002	7	64	71	10%	
2003	5	310	315	2%	
2004		27	27	0%	
ST0001294 Total		97	1,386	1,483	7%
ST0001297	1983	3	3	6	50%
	1984	2	5	7	29%
	1985	3	12	15	20%
	1986	9	18	27	33%
	1987	13	16	29	45%
	1988	11	36	47	23%
	1989	9	45	54	17%
	1990	12	64	76	16%
	1991	11	62	73	15%
	1992	25	87	112	22%
	1993	12	139	151	8%
	1994	20	181	201	10%
	1995	23	199	222	10%
	1996	71	168	239	30%
	1997	46	170	216	21%
	1998	36	150	186	19%
	1999	28	180	208	13%
2000	32	194	226	14%	
2001	25	151	176	14%	
2002	9	75	84	11%	
2003	5	120	125	4%	
2004	2	7	9	22%	
ST0001297 Total		407	2,082	2,489	16%

Table (a) (3 & 4). # of Tests by Station, % Fail By Station					
Station ID	Model Year	Fail	Pass	Total	% Fail
ST0001299	1983		1	1	0%
	1984	5	9	14	36%
	1985	3	6	9	33%
	1986	3	13	16	19%
	1987	4	21	25	16%
	1988	8	24	32	25%
	1989	4	32	36	11%
	1990	9	30	39	23%
	1991	8	43	51	16%
	1992	9	60	69	13%
	1993	11	91	102	11%
	1994	9	120	129	7%
	1995	25	184	209	12%
	1996	32	144	176	18%
	1997	25	180	205	12%
	1998	26	227	253	10%
	1999	25	250	275	9%
	2000	23	255	278	8%
	2001	15	180	195	8%
	2002	3	74	77	4%
2003	8	161	169	5%	
2004	1	42	43	2%	
ST0001299 Total		256	2,147	2,403	11%
ST0001303	1983		2	2	0%
	1984	3	2	5	60%
	1985		3	3	0%
	1986	4	6	10	40%
	1987	2	13	15	13%
	1988	2	14	16	13%
	1989	4	22	26	15%
	1990	2	28	30	7%
	1991	3	36	39	8%
	1992	7	52	59	12%
	1993	4	81	85	5%
	1994	4	85	89	4%
	1995	11	130	141	8%
	1996	24	91	115	21%
	1997	21	138	159	13%
	1998	29	141	170	17%
	1999	14	179	193	7%
	2000	29	223	252	12%
	2001	17	180	197	9%
	2002	8	87	95	8%
2003	11	140	151	7%	
2004	1	24	25	4%	
ST0001303 Total		200	1,677	1,877	11%

Table (a) (3 & 4). # of Tests by Station, % Fail By Station					
Station ID	Model Year	Fail	Pass	Total	% Fail
ST0001363	1983	1		1	100%
	1984	2	3	5	40%
	1985	4	2	6	67%
	1986	5	15	20	25%
	1987	5	14	19	26%
	1988	5	32	37	14%
	1989	8	35	43	19%
	1990	13	46	59	22%
	1991	12	54	66	18%
	1992	19	91	110	17%
	1993	20	105	125	16%
	1994	21	153	174	12%
	1995	29	201	230	13%
	1996	37	165	202	18%
	1997	59	219	278	21%
	1998	41	206	247	17%
	1999	28	218	246	11%
	2000	38	328	366	10%
	2001	30	268	298	10%
2002	12	127	139	9%	
2003	4	249	253	2%	
2004		34	34	0%	
ST0001363 Total		393	2,565	2,958	13%
ST0001368	1984	2	7	9	22%
	1985	3	9	12	25%
	1986	3	22	25	12%
	1987	4	26	30	13%
	1988	2	36	38	5%
	1989	5	43	48	10%
	1990	7	50	57	12%
	1991	2	62	64	3%
	1992	7	82	89	8%
	1993	7	129	136	5%
	1994	4	143	147	3%
	1995	7	222	229	3%
	1996	26	186	212	12%
	1997	31	278	309	10%
	1998	25	289	314	8%
	1999	26	494	520	5%
	2000	35	839	874	4%
	2001	41	749	790	5%
	2002	5	157	162	3%
2003	12	806	818	1%	
2004	3	57	60	5%	
ST0001368 Total		257	4,686	4,943	5%

Table (a) (3 & 4). # of Tests by Station, % Fail By Station					
Station ID	Model Year	Fail	Pass	Total	% Fail
ST0001371	1983		1	1	0%
	1984	2	4	6	33%
	1985	2	15	17	12%
	1986	5	20	25	20%
	1987	8	22	30	27%
	1988	3	60	63	5%
	1989	7	60	67	10%
	1990	10	59	69	14%
	1991	3	64	67	4%
	1992	13	109	122	11%
	1993	10	113	123	8%
	1994	9	163	172	5%
	1995	20	241	261	8%
	1996	29	182	211	14%
	1997	31	240	271	11%
	1998	20	245	265	8%
	1999	32	372	404	8%
	2000	28	565	593	5%
	2001	42	464	506	8%
	2002	4	141	145	3%
2003	17	639	656	3%	
2004	6	208	214	3%	
2005		2	2	0%	
ST0001371 Total		301	3,989	4,290	7%
ST0001377	1983		3	3	0%
	1984	2	3	5	40%
	1985	2	12	14	14%
	1986	4	17	21	19%
	1987	3	25	28	11%
	1988	6	45	51	12%
	1989	8	54	62	13%
	1990	13	45	58	22%
	1991	7	68	75	9%
	1992	12	85	97	12%
	1993	9	112	121	7%
	1994	16	134	150	11%
	1995	25	241	266	9%
	1996	53	203	256	21%
	1997	32	248	280	11%
	1998	41	243	284	14%
	1999	33	325	358	9%
	2000	43	422	465	9%
	2001	29	403	432	7%
	2002	14	145	159	9%
2003	13	422	435	3%	
2004	3	84	87	3%	
ST0001377 Total		368	3,339	3,707	10%

Table (a) (3 & 4). # of Tests by Station, % Fail By Station					
Station ID	Model Year	Fail	Pass	Total	% Fail
ST0001401	1984	4	12	16	25%
	1985	6	10	16	38%
	1986	8	14	22	36%
	1987	13	34	47	28%
	1988	8	29	37	22%
	1989	16	41	57	28%
	1990	19	56	75	25%
	1991	17	59	76	22%
	1992	17	98	115	15%
	1993	17	128	145	12%
	1994	20	154	174	11%
	1995	23	203	226	10%
	1996	31	157	188	16%
	1997	49	215	264	19%
	1998	35	194	229	15%
	1999	37	196	233	16%
	2000	41	246	287	14%
2001	28	199	227	12%	
2002	6	108	114	5%	
2003	9	162	171	5%	
2004	2	51	53	4%	
ST0001401 Total		406	2,366	2,772	15%
ST0001423	1983	1		1	100%
	1984	1	4	5	20%
	1985	1	6	7	14%
	1986	6	18	24	25%
	1987	4	23	27	15%
	1988	5	29	34	15%
	1989	9	44	53	17%
	1990	11	65	76	14%
	1991	21	89	110	19%
	1992	19	84	103	18%
	1993	18	132	150	12%
	1994	18	182	200	9%
	1995	19	263	282	7%
	1996	45	250	295	15%
	1997	39	325	364	11%
	1998	37	290	327	11%
	1999	31	373	404	8%
2000	33	462	495	7%	
2001	29	502	531	5%	
2002	8	473	481	2%	
2003	16	1156	1172	1%	
2004	18	1367	1385	1%	
ST0001423 Total		389	6,137	6,526	6%

Table (a) (3 & 4). # of Tests by Station, % Fail By Station					
Station ID	Model Year	Fail	Pass	Total	% Fail
ST0001470	1982		1	1	0%
	1983	1	3	4	25%
	1984	2	6	8	25%
	1985	8	8	16	50%
	1986	12	26	38	32%
	1987	6	26	32	19%
	1988	10	60	70	14%
	1989	5	66	71	7%
	1990	8	47	55	15%
	1991	7	57	64	11%
	1992	8	75	83	10%
	1993	11	111	122	9%
	1994	22	146	168	13%
	1995	15	182	197	8%
	1996	28	169	197	14%
	1997	20	209	229	9%
	1998	22	177	199	11%
	1999	25	305	330	8%
	2000	39	412	451	9%
	2001	35	387	422	8%
2002	6	130	136	4%	
2003	19	444	463	4%	
2004	3	121	124	2%	
ST0001470 Total		312	3,168	3,480	9%
ST0001511	1983	1	3	4	25%
	1984	5	3	8	63%
	1985	1	17	18	6%
	1986	6	18	24	25%
	1987	7	48	55	13%
	1988	14	54	68	21%
	1989	9	52	61	15%
	1990	9	73	82	11%
	1991	5	48	53	9%
	1992	13	100	113	12%
	1993	13	130	143	9%
	1994	14	175	189	7%
	1995	10	260	270	4%
	1996	20	194	214	9%
	1997	31	277	308	10%
	1998	16	272	288	6%
	1999	29	353	382	8%
	2000	37	504	541	7%
	2001	28	462	490	6%
	2002	9	114	123	7%
2003	8	463	471	2%	
2004		65	65	0%	
ST0001511 Total		285	3,685	3,970	7%

Table (a) (3 & 4). # of Tests by Station, % Fail By Station					
Station ID	Model Year	Fail	Pass	Total	% Fail
ST0001519	1983	1	3	4	25%
	1984	7	30	37	19%
	1985	14	52	66	21%
	1986	18	55	73	25%
	1987	15	69	84	18%
	1988	18	106	124	15%
	1989	16	108	124	13%
	1990	14	94	108	13%
	1991	11	122	133	8%
	1992	15	130	145	10%
	1993	27	222	249	11%
	1994	21	297	318	7%
	1995	39	355	394	10%
	1996	55	292	347	16%
	1997	41	450	491	8%
	1998	29	351	380	8%
	1999	44	526	570	8%
	2000	51	724	775	7%
	2001	40	678	718	6%
	2002	9	252	261	3%
2003	14	737	751	2%	
2004	2	207	209	1%	
ST0001519 Total		501	5,860	6,361	8%
ST0001594	1983	1	1	2	50%
	1984	3	7	10	30%
	1985	2	9	11	18%
	1986	4	16	20	20%
	1987	3	19	22	14%
	1988	7	28	35	20%
	1989	5	34	39	13%
	1990	5	53	58	9%
	1991	9	49	58	16%
	1992	7	65	72	10%
	1993	9	82	91	10%
	1994	7	120	127	6%
	1995	7	148	155	5%
	1996	17	111	128	13%
	1997	32	167	199	16%
	1998	20	163	183	11%
	1999	27	232	259	10%
	2000	20	294	314	6%
	2001	11	251	262	4%
	2002	7	106	113	6%
2003	8	302	310	3%	
2004	1	162	163	1%	
ST0001594 Total		212	2,419	2,631	8%

Table (a) (3 & 4). # of Tests by Station, % Fail By Station					
Station ID	Model Year	Fail	Pass	Total	% Fail
ST0001613	1983	1	1	2	50%
	1984	2	9	11	18%
	1985	4	14	18	22%
	1986	3	21	24	13%
	1987	7	28	35	20%
	1988	11	47	58	19%
	1989	12	47	59	20%
	1990	8	64	72	11%
	1991	13	75	88	15%
	1992	12	97	109	11%
	1993	13	165	178	7%
	1994	12	200	212	6%
	1995	17	230	247	7%
	1996	35	198	233	15%
	1997	36	304	340	11%
	1998	35	297	332	11%
	1999	28	379	407	7%
	2000	46	537	583	8%
	2001	41	482	523	8%
2002	15	213	228	7%	
2003	15	574	589	3%	
2004	8	233	241	3%	
ST0001613 Total		374	4,215	4,589	8%
ST0001615	1984	1	1	2	50%
	1985	3	3	6	50%
	1986	8	13	21	38%
	1987	3	13	16	19%
	1988	2	17	19	11%
	1989	5	23	28	18%
	1990	7	26	33	21%
	1991	6	35	41	15%
	1992	3	43	46	7%
	1993	8	66	74	11%
	1994	12	107	119	10%
	1995	10	107	117	9%
	1996	20	90	110	18%
	1997	21	112	133	16%
	1998	17	130	147	12%
	1999	15	163	178	8%
	2000	25	190	215	12%
	2001	19	176	195	10%
	2002	6	64	70	9%
2003	9	166	175	5%	
2004		42	42	0%	
ST0001615 Total		200	1,587	1,787	11%

Table (a) (3 & 4). # of Tests by Station, % Fail By Station					
Station ID	Model Year	Fail	Pass	Total	% Fail
ST0001646	1983	1	2	3	33%
	1984	6	25	31	19%
	1985	5	23	28	18%
	1986	9	39	48	19%
	1987	9	39	48	19%
	1988	9	43	52	17%
	1989	10	68	78	13%
	1990	12	62	74	16%
	1991	12	78	90	13%
	1992	17	88	105	16%
	1993	12	140	152	8%
	1994	17	201	218	8%
	1995	19	241	260	7%
	1996	36	206	242	15%
	1997	36	270	306	12%
	1998	23	319	342	7%
	1999	33	351	384	9%
	2000	37	510	547	7%
2001	34	466	500	7%	
2002	19	171	190	10%	
2003	27	548	575	5%	
2004	1	107	108	1%	
ST0001646 Total		384	3,997	4,381	9%
ST0001660	1983	3		3	100%
	1984	2	10	12	17%
	1985	4	9	13	31%
	1986	4	22	26	15%
	1987	5	38	43	12%
	1988	9	40	49	18%
	1989	4	52	56	7%
	1990	17	49	66	26%
	1991	15	81	96	16%
	1992	12	76	88	14%
	1993	20	152	172	12%
	1994	20	214	234	9%
	1995	19	236	255	7%
	1996	26	261	287	9%
	1997	48	338	386	12%
	1998	42	400	442	10%
	1999	35	482	517	7%
	2000	43	694	737	6%
2001	54	709	763	7%	
2002	30	324	354	8%	
2003	19	893	912	2%	
2004	8	397	405	2%	
ST0001660 Total		439	5,477	5,916	7%

Table (a) (3 & 4). # of Tests by Station, % Fail By Station					
Station ID	Model Year	Fail	Pass	Total	% Fail
ST0001662	1983	2	1	3	67%
	1984	4	9	13	31%
	1985	4	14	18	22%
	1986	4	24	28	14%
	1987	4	28	32	13%
	1988	3	30	33	9%
	1989	5	46	51	10%
	1990	5	49	54	9%
	1991	8	62	70	11%
	1992	13	91	104	13%
	1993	13	127	140	9%
	1994	10	173	183	5%
	1995	10	204	214	5%
	1996	29	180	209	14%
	1997	27	237	264	10%
	1998	24	238	262	9%
	1999	30	329	359	8%
	2000	35	468	503	7%
	2001	34	458	492	7%
	2002	8	172	180	4%
2003	19	563	582	3%	
2004	6	178	184	3%	
ST0001662 Total		297	3,681	3,978	7%
ST0001679	1983	1		1	100%
	1984	10	17	27	37%
	1985	12	18	30	40%
	1986	11	34	45	24%
	1987	16	38	54	30%
	1988	21	59	80	26%
	1989	10	56	66	15%
	1990	19	89	108	18%
	1991	16	81	97	16%
	1992	20	109	129	16%
	1993	21	157	178	12%
	1994	38	256	294	13%
	1995	32	283	315	10%
	1996	29	210	239	12%
	1997	32	360	392	8%
	1998	45	376	421	11%
	1999	36	450	486	7%
	2000	63	607	670	9%
	2001	40	690	730	5%
	2002	19	180	199	10%
2003	23	677	700	3%	
2004	2	99	101	2%	
ST0001679 Total		516	4,846	5,362	10%

Table (a) (3 & 4). # of Tests by Station, % Fail By Station					
Station ID	Model Year	Fail	Pass	Total	% Fail
ST0001704	1983	1	2	3	33%
	1984	7	7	14	50%
	1985	13	20	33	39%
	1986	9	33	42	21%
	1987	9	42	51	18%
	1988	17	59	76	22%
	1989	18	74	92	20%
	1990	13	74	87	15%
	1991	9	83	92	10%
	1992	13	93	106	12%
	1993	20	126	146	14%
	1994	20	188	208	10%
	1995	13	253	266	5%
	1996	32	184	216	15%
	1997	26	262	288	9%
	1998	29	277	306	9%
	1999	28	363	391	7%
	2000	35	445	480	7%
2001	40	433	473	8%	
2002	8	118	126	6%	
2003	10	454	464	2%	
2004		40	40	0%	
ST0001704 Total		370	3,630	4,000	9%
ST0001725	1983		2	2	0%
	1984	3	9	12	25%
	1985	5	18	23	22%
	1986	5	39	44	11%
	1987	5	50	55	9%
	1988	11	53	64	17%
	1989	7	74	81	9%
	1990	3	67	70	4%
	1991	3	76	79	4%
	1992	6	115	121	5%
	1993	5	123	128	4%
	1994	5	177	182	3%
	1995	6	248	254	2%
	1996	24	240	264	9%
	1997	34	301	335	10%
	1998	29	306	335	9%
	1999	33	401	434	8%
	2000	38	628	666	6%
2001	29	570	599	5%	
2002	14	140	154	9%	
2003	16	593	609	3%	
2004	1	41	42	2%	
ST0001725 Total		282	4,271	4,553	6%

Table (a) (3 & 4). # of Tests by Station, % Fail By Station					
Station ID	Model Year	Fail	Pass	Total	% Fail
ST0001767	1983		1	1	0%
	1984	3	12	15	20%
	1985	4	12	16	25%
	1986	8	25	33	24%
	1987	14	46	60	23%
	1988	13	61	74	18%
	1989	27	72	99	27%
	1990	21	89	110	19%
	1991	18	98	116	16%
	1992	28	153	181	15%
	1993	39	244	283	14%
	1994	33	302	335	10%
	1995	38	387	425	9%
	1996	72	357	429	17%
	1997	79	456	535	15%
	1998	73	458	531	14%
	1999	63	654	717	9%
	2000	79	926	1005	8%
	2001	88	864	952	9%
	2002	33	332	365	9%
2003	28	1001	1029	3%	
2004	2	183	185	1%	
ST0001767 Total		763	6,733	7,496	10%
ST0001797	1982	1		1	100%
	1983		2	2	0%
	1984	1	5	6	17%
	1985	7	5	12	58%
	1986	3	22	25	12%
	1987	3	17	20	15%
	1988	8	23	31	26%
	1989	7	30	37	19%
	1990	3	28	31	10%
	1991	3	35	38	8%
	1992		53	53	0%
	1993	6	58	64	9%
	1994	9	86	95	9%
	1995	1	113	114	1%
	1996	15	93	108	14%
	1997	13	112	125	10%
	1998	7	134	141	5%
	1999	17	175	192	9%
	2000	22	268	290	8%
	2001	18	287	305	6%
2002	5	73	78	6%	
2003	8	229	237	3%	
2004		34	34	0%	
ST0001797 Total		157	1,882	2,039	8%

Table (a) (3 & 4). # of Tests by Station, % Fail By Station					
Station ID	Model Year	Fail	Pass	Total	% Fail
ST0001799	1983		1	1	0%
	1984	6	11	17	35%
	1985	8	17	25	32%
	1986	7	28	35	20%
	1987	9	30	39	23%
	1988	7	38	45	16%
	1989	6	43	49	12%
	1990	15	48	63	24%
	1991	6	64	70	9%
	1992	11	72	83	13%
	1993	13	105	118	11%
	1994	12	139	151	8%
	1995	13	192	205	6%
	1996	17	184	201	8%
	1997	23	234	257	9%
	1998	16	215	231	7%
	1999	15	328	343	4%
	2000	45	501	546	8%
	2001	43	519	562	8%
	2002	6	128	134	4%
2003	14	538	552	3%	
2004	3	63	66	5%	
ST0001799 Total		295	3,498	3,793	8%
ST0001805	1983	1		1	100%
	1984	11	21	32	34%
	1985	22	32	54	41%
	1986	19	43	62	31%
	1987	19	61	80	24%
	1988	23	115	138	17%
	1989	26	113	139	19%
	1990	28	118	146	19%
	1991	7	109	116	6%
	1992	29	178	207	14%
	1993	33	260	293	11%
	1994	39	325	364	11%
	1995	32	466	498	6%
	1996	61	341	402	15%
	1997	89	547	636	14%
	1998	71	518	589	12%
	1999	62	638	700	9%
	2000	87	921	1008	9%
	2001	62	812	874	7%
	2002	27	277	304	9%
2003	54	912	966	6%	
2004	4	127	131	3%	
ST0001805 Total		806	6,934	7,740	10%

Table (a) (3 & 4). # of Tests by Station, % Fail By Station					
Station ID	Model Year	Fail	Pass	Total	% Fail
ST0001835	1983	3	1	4	75%
	1984	8	14	22	36%
	1985	14	17	31	45%
	1986	10	36	46	22%
	1987	10	55	65	15%
	1988	19	101	120	16%
	1989	13	83	96	14%
	1990	17	86	103	17%
	1991	18	110	128	14%
	1992	18	144	162	11%
	1993	19	200	219	9%
	1994	26	276	302	9%
	1995	19	339	358	5%
	1996	48	302	350	14%
	1997	58	407	465	12%
	1998	57	447	504	11%
	1999	49	576	625	8%
	2000	50	784	834	6%
	2001	60	686	746	8%
	2002	19	201	220	9%
2003	29	851	880	3%	
2004	3	176	179	2%	
ST0001835 Total		567	5,892	6,459	9%
ST0001852	1982		1	1	0%
	1983	1	4	5	20%
	1984	3	13	16	19%
	1985	9	30	39	23%
	1986	4	44	48	8%
	1987	3	40	43	7%
	1988	13	67	80	16%
	1989	10	80	90	11%
	1990	7	67	74	9%
	1991	9	80	89	10%
	1992	9	123	132	7%
	1993	11	160	171	6%
	1994	17	214	231	7%
	1995	9	262	271	3%
	1996	28	223	251	11%
	1997	38	286	324	12%
	1998	28	312	340	8%
	1999	30	379	409	7%
	2000	42	641	683	6%
	2001	37	567	604	6%
2002	9	219	228	4%	
2003	28	593	621	5%	
2004	1	104	105	1%	
ST0001852 Total		346	4,509	4,855	7%

Table (a) (3 & 4). # of Tests by Station, % Fail By Station					
Station ID	Model Year	Fail	Pass	Total	% Fail
ST0001876	1983	1	5	6	17%
	1984	8	25	33	24%
	1985	6	31	37	16%
	1986	16	36	52	31%
	1987	13	80	93	14%
	1988	16	100	116	14%
	1989	16	138	154	10%
	1990	19	150	169	11%
	1991	14	168	182	8%
	1992	17	181	198	9%
	1993	23	274	297	8%
	1994	21	322	343	6%
	1995	33	429	462	7%
	1996	55	391	446	12%
	1997	57	569	626	9%
	1998	71	558	629	11%
	1999	54	711	765	7%
	2000	66	1144	1210	5%
	2001	61	1076	1137	5%
	2002	18	289	307	6%
2003	22	1133	1155	2%	
2004	2	141	143	1%	
ST0001876 Total		609	7,951	8,560	7%
ST0001889	1983	2	2	4	50%
	1984	10	11	21	48%
	1985	12	9	21	57%
	1986	10	29	39	26%
	1987	10	39	49	20%
	1988	11	52	63	17%
	1989	13	64	77	17%
	1990	10	64	74	14%
	1991	13	62	75	17%
	1992	10	98	108	9%
	1993	16	128	144	11%
	1994	14	169	183	8%
	1995	16	224	240	7%
	1996	22	224	246	9%
	1997	25	298	323	8%
	1998	25	316	341	7%
	1999	32	441	473	7%
	2000	35	637	672	5%
	2001	35	671	706	5%
	2002	8	270	278	3%
2003	13	671	684	2%	
2004	3	127	130	2%	
ST0001889 Total		345	4,606	4,951	7%

Table (a) (3 & 4). # of Tests by Station, % Fail By Station					
Station ID	Model Year	Fail	Pass	Total	% Fail
ST0001896	1984	5	11	16	31%
	1985	3	15	18	17%
	1986	7	15	22	32%
	1987	6	27	33	18%
	1988	8	46	54	15%
	1989	9	50	59	15%
	1990	8	48	56	14%
	1991	7	62	69	10%
	1992	7	85	92	8%
	1993	8	85	93	9%
	1994	9	143	152	6%
	1995	15	169	184	8%
	1996	28	182	210	13%
	1997	18	238	256	7%
	1998	17	237	254	7%
	1999	27	358	385	7%
	2000	26	498	524	5%
	2001	37	505	542	7%
2002	9	143	152	6%	
2003	21	563	584	4%	
2004	3	115	118	3%	
ST0001896 Total		278	3,595	3,873	7%
ST0001944	1983		1	1	0%
	1984	4	14	18	22%
	1985	4	22	26	15%
	1986	9	35	44	20%
	1987	9	58	67	13%
	1988	10	55	65	15%
	1989	8	70	78	10%
	1990	8	90	98	8%
	1991	11	95	106	10%
	1992	15	109	124	12%
	1993	13	187	200	7%
	1994	19	239	258	7%
	1995	11	337	348	3%
	1996	40	297	337	12%
	1997	53	440	493	11%
	1998	36	486	522	7%
	1999	57	676	733	8%
	2000	70	1012	1082	6%
2001	76	981	1057	7%	
2002	20	296	316	6%	
2003	35	998	1033	3%	
2004	2	206	208	1%	
ST0001944 Total		510	6,704	7,214	7%

Table (a) (3 & 4). # of Tests by Station, % Fail By Station					
Station ID	Model Year	Fail	Pass	Total	% Fail
ST0001969	1984	1	6	7	14%
	1985	2	8	10	20%
	1986	2	8	10	20%
	1987	1	15	16	6%
	1988	3	25	28	11%
	1989	5	40	45	11%
	1990	2	36	38	5%
	1991	4	23	27	15%
	1992	2	58	60	3%
	1993	8	77	85	9%
	1994	10	95	105	10%
	1995	6	140	146	4%
	1996	16	155	171	9%
	1997	20	238	258	8%
	1998	21	251	272	8%
	1999	24	365	389	6%
	2000	26	555	581	4%
	2001	27	515	542	5%
2002	7	135	142	5%	
2003	19	552	571	3%	
2004	1	61	62	2%	
ST0001969 Total		207	3,358	3,565	6%
ST0001970	1983		3	3	0%
	1984	2	9	11	18%
	1985	6	19	25	24%
	1986	2	30	32	6%
	1987	8	29	37	22%
	1988	7	48	55	13%
	1989	8	48	56	14%
	1990	8	57	65	12%
	1991	9	60	69	13%
	1992	6	77	83	7%
	1993	13	114	127	10%
	1994	12	186	198	6%
	1995	12	211	223	5%
	1996	37	227	264	14%
	1997	20	335	355	6%
	1998	33	387	420	8%
	1999	32	470	502	6%
	2000	48	786	834	6%
2001	44	751	795	6%	
2002	13	167	180	7%	
2003	16	913	929	2%	
2004		103	103	0%	
ST0001970 Total		336	5,030	5,366	6%

Table (a) (3 & 4). # of Tests by Station, % Fail By Station					
Station ID	Model Year	Fail	Pass	Total	% Fail
ST0002018	1982		1	1	0%
	1983		4	4	0%
	1984		13	13	0%
	1985	4	20	24	17%
	1986	3	30	33	9%
	1987	4	39	43	9%
	1988	5	30	35	14%
	1989	7	38	45	16%
	1990	3	48	51	6%
	1991	7	46	53	13%
	1992	5	72	77	6%
	1993	4	89	93	4%
	1994	5	117	122	4%
	1995	5	153	158	3%
	1996	13	147	160	8%
	1997	14	199	213	7%
	1998	12	186	198	6%
	1999	12	314	326	4%
	2000	28	388	416	7%
	2001	16	366	382	4%
2002	5	107	112	4%	
2003	6	461	467	1%	
2004	1	44	45	2%	
ST0002018 Total		159	2,912	3,071	5%
ST0002020	1984		3	3	0%
	1985		2	2	0%
	1986		3	3	0%
	1987	1	4	5	20%
	1988	1	3	4	25%
	1989	1		1	100%
	1990		6	6	0%
	1991	2	10	12	17%
	1992	1	5	6	17%
	1993		9	9	0%
	1994	1	13	14	7%
	1995	2	27	29	7%
	1996	6	24	30	20%
	1997	2	39	41	5%
	1998	3	47	50	6%
	1999		69	69	0%
	2000	9	144	153	6%
	2001	24	299	323	7%
	2002	3	46	49	6%
	2003	9	267	276	3%
2004	1	74	75	1%	
ST0002020 Total		66	1,094	1,160	6%

Table (a) (3 & 4). # of Tests by Station, % Fail By Station					
Station ID	Model Year	Fail	Pass	Total	% Fail
ST0002026	1984	4	7	11	36%
	1985	5	12	17	29%
	1986	7	22	29	24%
	1987	8	33	41	20%
	1988	7	37	44	16%
	1989	2	45	47	4%
	1990	7	27	34	21%
	1991	5	45	50	10%
	1992	5	56	61	8%
	1993	5	97	102	5%
	1994	10	144	154	6%
	1995	8	162	170	5%
	1996	14	133	147	10%
	1997	24	207	231	10%
	1998	11	184	195	6%
	1999	25	227	252	10%
	2000	19	368	387	5%
	2001	20	290	310	6%
2002	6	52	58	10%	
2003	18	359	377	5%	
2004		59	59	0%	
ST0002026 Total		210	2,566	2,776	8%
ST0002060	1983		2	2	0%
	1984	7	9	16	44%
	1985	8	18	26	31%
	1986	6	12	18	33%
	1987	14	29	43	33%
	1988	12	55	67	18%
	1989	12	51	63	19%
	1990	4	65	69	6%
	1991	11	61	72	15%
	1992	4	79	83	5%
	1993	17	126	143	12%
	1994	11	166	177	6%
	1995	20	217	237	8%
	1996	44	195	239	18%
	1997	38	272	310	12%
	1998	30	295	325	9%
	1999	32	416	448	7%
	2000	56	581	637	9%
2001	72	529	601	12%	
2002	12	136	148	8%	
2003	29	591	620	5%	
2004		39	39	0%	
ST0002060 Total		439	3,944	4,383	10%

Table (a) (3 & 4). # of Tests by Station, % Fail By Station					
Station ID	Model Year	Fail	Pass	Total	% Fail
ST0002080	1984		1	1	0%
	1987		1	1	0%
	1990		1	1	0%
	1992		3	3	0%
	1994	1	1	2	50%
	1995		4	4	0%
	1996		9	9	0%
	1997	1	8	9	11%
	1998	1	5	6	17%
	1999		7	7	0%
	2000	1	6	7	14%
	2001	1	16	17	6%
	2002		8	8	0%
	2003	3	13	16	19%
2004	1	2	3	33%	
ST0002080 Total		9	85	94	10%
ST0002120	1983		1	1	0%
	1984		3	3	0%
	1985	7	6	13	54%
	1986	4	15	19	21%
	1987	5	16	21	24%
	1988	2	25	27	7%
	1989	2	32	34	6%
	1990	1	33	34	3%
	1991	2	30	32	6%
	1992	5	38	43	12%
	1993	2	42	44	5%
	1994		72	72	0%
	1995	3	73	76	4%
	1996	20	86	106	19%
	1997	6	128	134	4%
	1998	9	130	139	6%
	1999	15	201	216	7%
	2000	11	309	320	3%
2001	18	352	370	5%	
2002	4	68	72	6%	
2003	14	382	396	4%	
2004	1	41	42	2%	
ST0002120 Total		131	2,083	2,214	6%

Table (a) (3 & 4). # of Tests by Station, % Fail By Station					
Station ID	Model Year	Fail	Pass	Total	% Fail
ST0002133	1983	1		1	100%
	1984		5	5	0%
	1985	1	5	6	17%
	1986	2	14	16	13%
	1987	6	17	23	26%
	1988	7	29	36	19%
	1989	8	31	39	21%
	1990	5	45	50	10%
	1991	4	37	41	10%
	1992	8	68	76	11%
	1993	6	90	96	6%
	1994	13	120	133	10%
	1995	17	184	201	8%
	1996	13	145	158	8%
	1997	22	186	208	11%
	1998	20	225	245	8%
	1999	33	354	387	9%
	2000	46	485	531	9%
	2001	31	469	500	6%
	2002	9	140	149	6%
2003	14	582	596	2%	
2004	3	118	121	2%	
ST0002133 Total		269	3,349	3,618	7%
ST0002134	1983		1	1	0%
	1984	3	3	6	50%
	1985	3	4	7	43%
	1986	3	10	13	23%
	1987	7	23	30	23%
	1988	6	16	22	27%
	1989	4	41	45	9%
	1990	4	25	29	14%
	1991	4	26	30	13%
	1992	13	43	56	23%
	1993	6	66	72	8%
	1994	3	77	80	4%
	1995	7	93	100	7%
	1996	16	102	118	14%
	1997	9	113	122	7%
	1998	8	128	136	6%
	1999	13	182	195	7%
	2000	13	223	236	6%
	2001	12	211	223	5%
	2002	7	64	71	10%
2003	3	214	217	1%	
2004	2	14	16	13%	
2005		1	1	0%	
ST0002134 Total		146	1,680	1,826	8%

Table (a) (3 & 4). # of Tests by Station, % Fail By Station					
Station ID	Model Year	Fail	Pass	Total	% Fail
ST0002141	1983		1	1	0%
	1984	1	3	4	25%
	1985		2	2	0%
	1986	1	7	8	13%
	1987		11	11	0%
	1988	2	6	8	25%
	1989	1	15	16	6%
	1990	1	19	20	5%
	1991	5	21	26	19%
	1992	1	23	24	4%
	1993	5	33	38	13%
	1994	5	50	55	9%
	1995	4	73	77	5%
	1996	6	74	80	8%
	1997	10	86	96	10%
	1998	8	137	145	6%
	1999	9	176	185	5%
	2000	18	290	308	6%
	2001	13	310	323	4%
	2002	8	101	109	7%
2003	6	350	356	2%	
2004	1	44	45	2%	
ST0002141 Total		105	1,832	1,937	5%
ST0002143	1985		1	1	0%
	1996		1	1	0%
	1997		1	1	0%
	1998		1	1	0%
	1999		4	4	0%
	2000		1	1	0%
	2001	1	1	2	50%
2003	1	2	3	33%	
ST0002143 Total		2	12	14	14%

Table (a) (3 & 4). # of Tests by Station, % Fail By Station					
Station ID	Model Year	Fail	Pass	Total	% Fail
ST0002149	1983	1		1	100%
	1984	3	5	8	38%
	1985	3	8	11	27%
	1986	9	16	25	36%
	1987	2	11	13	15%
	1988	5	23	28	18%
	1989	3	24	27	11%
	1990	6	34	40	15%
	1991	6	42	48	13%
	1992	5	54	59	8%
	1993	10	68	78	13%
	1994	8	94	102	8%
	1995	10	107	117	9%
	1996	19	97	116	16%
	1997	24	169	193	12%
	1998	17	145	162	10%
	1999	17	204	221	8%
	2000	25	286	311	8%
	2001	19	300	319	6%
	2002	7	100	107	7%
2003	8	322	330	2%	
2004		79	79	0%	
ST0002149 Total		207	2,188	2,395	9%
ST0002153	1983		1	1	0%
	1984	3	11	14	21%
	1985	3	17	20	15%
	1986	7	26	33	21%
	1987	7	38	45	16%
	1988	4	42	46	9%
	1989	6	64	70	9%
	1990	8	40	48	17%
	1991	6	78	84	7%
	1992	6	70	76	8%
	1993	9	104	113	8%
	1994	6	141	147	4%
	1995	9	190	199	5%
	1996	16	176	192	8%
	1997	20	253	273	7%
	1998	19	253	272	7%
	1999	30	357	387	8%
	2000	33	566	599	6%
	2001	33	534	567	6%
	2002	9	109	118	8%
2003	15	588	603	2%	
2004	1	48	49	2%	
ST0002153 Total		250	3,706	3,956	6%

Table (a) (3 & 4). # of Tests by Station, % Fail By Station					
Station ID	Model Year	Fail	Pass	Total	% Fail
ST0002175	1982	1		1	100%
	1983		4	4	0%
	1984		6	6	0%
	1985	2	2	4	50%
	1986	1	4	5	20%
	1987		6	6	0%
	1988	1	6	7	14%
	1989	2	8	10	20%
	1990	1	12	13	8%
	1991	3	12	15	20%
	1992	1	15	16	6%
	1993		28	28	0%
	1994	3	29	32	9%
	1995	3	43	46	7%
	1996	3	31	34	9%
	1997	3	55	58	5%
	1998	3	56	59	5%
	1999	2	93	95	2%
	2000	5	148	153	3%
	2001	1	49	50	2%
2002	1	52	53	2%	
2003	2	207	209	1%	
2004		79	79	0%	
ST0002175 Total		38	945	983	4%
ST0002178	1983	1	5	6	17%
	1984		16	16	0%
	1985	4	23	27	15%
	1986	5	25	30	17%
	1987	4	31	35	11%
	1988	5	33	38	13%
	1989	2	44	46	4%
	1990	6	40	46	13%
	1991	6	58	64	9%
	1992	10	67	77	13%
	1993	9	92	101	9%
	1994	6	104	110	5%
	1995	10	168	178	6%
	1996	26	131	157	17%
	1997	27	188	215	13%
	1998	17	192	209	8%
	1999	26	261	287	9%
	2000	24	405	429	6%
	2001	18	371	389	5%
	2002	3	112	115	3%
2003	11	413	424	3%	
2004	1	61	62	2%	
ST0002178 Total		221	2,840	3,061	7%

Table (a) (3 & 4). # of Tests by Station, % Fail By Station					
Station ID	Model Year	Fail	Pass	Total	% Fail
ST0002181	1983	3		3	100%
	1984	3	21	24	13%
	1985	9	22	31	29%
	1986	7	36	43	16%
	1987	18	62	80	23%
	1988	17	84	101	17%
	1989	11	94	105	10%
	1990	11	110	121	9%
	1991	16	115	131	12%
	1992	12	139	151	8%
	1993	22	231	253	9%
	1994	22	288	310	7%
	1995	14	370	384	4%
	1996	51	362	413	12%
	1997	57	509	566	10%
	1998	50	557	607	8%
	1999	56	821	877	6%
	2000	70	1265	1335	5%
	2001	65	1110	1175	6%
	2002	21	287	308	7%
2003	50	1216	1266	4%	
2004	1	109	110	1%	
ST0002181 Total		586	7,808	8,394	7%
ST0002233	1983	1	2	3	33%
	1984	3	16	19	16%
	1985	7	24	31	23%
	1986	10	29	39	26%
	1987	18	42	60	30%
	1988	13	71	84	15%
	1989	7	72	79	9%
	1990	9	74	83	11%
	1991	10	100	110	9%
	1992	17	114	131	13%
	1993	17	180	197	9%
	1994	20	233	253	8%
	1995	26	283	309	8%
	1996	56	268	324	17%
	1997	44	304	348	13%
	1998	37	338	375	10%
	1999	38	452	490	8%
	2000	58	658	716	8%
	2001	42	615	657	6%
	2002	13	270	283	5%
2003	22	578	600	4%	
2004	4	174	178	2%	
2005		1	1	0%	
ST0002233 Total		472	4,898	5,370	9%

Table (a) (3 & 4). # of Tests by Station, % Fail By Station					
Station ID	Model Year	Fail	Pass	Total	% Fail
ST0002267	1984	2	4	6	33%
	1985	1	7	8	13%
	1986	3	9	12	25%
	1987	4	11	15	27%
	1988	3	19	22	14%
	1989	7	23	30	23%
	1990	6	24	30	20%
	1991	3	34	37	8%
	1992	7	35	42	17%
	1993	7	55	62	11%
	1994	8	74	82	10%
	1995	10	106	116	9%
	1996	12	95	107	11%
	1997	12	134	146	8%
	1998	9	113	122	7%
	1999	3	178	181	2%
	2000	14	328	342	4%
2001	14	278	292	5%	
2002	3	81	84	4%	
2003	4	419	423	1%	
2004	2	50	52	4%	
ST0002267 Total		134	2,077	2,211	6%
ST0002304	1983	1	2	3	33%
	1984	2	12	14	14%
	1985	3	21	24	13%
	1986	11	28	39	28%
	1987	11	37	48	23%
	1988	13	54	67	19%
	1989	6	60	66	9%
	1990	2	58	60	3%
	1991	12	74	86	14%
	1992	13	101	114	11%
	1993	14	111	125	11%
	1994	8	181	189	4%
	1995	11	221	232	5%
	1996	34	174	208	16%
	1997	27	226	253	11%
	1998	41	271	312	13%
	1999	21	310	331	6%
2000	45	557	602	7%	
2001	35	612	647	5%	
2002	9	131	140	6%	
2003	14	514	528	3%	
2004	3	92	95	3%	
ST0002304 Total		336	3,847	4,183	8%

Table (a) (3 & 4). # of Tests by Station, % Fail By Station					
Station ID	Model Year	Fail	Pass	Total	% Fail
ST0002318	1983		2	2	0%
	1984	3	4	7	43%
	1985	1	7	8	13%
	1986	2	11	13	15%
	1987	4	15	19	21%
	1988	9	26	35	26%
	1989	1	23	24	4%
	1990	3	25	28	11%
	1991	1	26	27	4%
	1992	5	33	38	13%
	1993	8	59	67	12%
	1994	4	53	57	7%
	1995	4	82	86	5%
	1996	12	70	82	15%
	1997	5	87	92	5%
	1998	4	80	84	5%
	1999	7	93	100	7%
	2000	12	114	126	10%
	2001	13	105	118	11%
	2002	2	49	51	4%
2003	3	108	111	3%	
2004		11	11	0%	
2005		1	1	0%	
ST0002318 Total		103	1,084	1,187	9%
ST0002330	1984		7	7	0%
	1985	2	4	6	33%
	1986	5	12	17	29%
	1987	4	14	18	22%
	1988	4	27	31	13%
	1989	1	12	13	8%
	1990	5	23	28	18%
	1991	6	18	24	25%
	1992	4	32	36	11%
	1993	5	39	44	11%
	1994	4	56	60	7%
	1995	7	66	73	10%
	1996	7	55	62	11%
	1997	8	69	77	10%
	1998	7	62	69	10%
	1999	7	105	112	6%
	2000	10	199	209	5%
2001	25	287	312	8%	
2002	3	50	53	6%	
2003	5	214	219	2%	
2004		18	18	0%	
ST0002330 Total		119	1,369	1,488	8%

Table (a) (3 & 4). # of Tests by Station, % Fail By Station					
Station ID	Model Year	Fail	Pass	Total	% Fail
ST0002340	1984		3	3	0%
	1985	2	2	4	50%
	1986	1	4	5	20%
	1987		10	10	0%
	1988	1	11	12	8%
	1989		11	11	0%
	1990	1	15	16	6%
	1991	3	13	16	19%
	1992	2	14	16	13%
	1993	3	25	28	11%
	1994	2	36	38	5%
	1995	2	37	39	5%
	1996	8	37	45	18%
	1997	5	73	78	6%
	1998	7	80	87	8%
	1999	7	92	99	7%
	2000	6	165	171	4%
	2001	15	165	180	8%
	2002		84	84	0%
	2003	6	243	249	2%
2004	2	171	173	1%	
2005		1	1	0%	
ST0002340 Total		73	1,292	1,365	5%
ST0002351	1984		1	1	0%
	1986	1	1	2	50%
	1987	3		3	100%
	1988		3	3	0%
	1989		3	3	0%
	1990		2	2	0%
	1991		2	2	0%
	1992	1	6	7	14%
	1993	1	5	6	17%
	1994		9	9	0%
	1995	1	14	15	7%
	1996	3	10	13	23%
	1997		20	20	0%
	1998		22	22	0%
	1999	2	41	43	5%
	2000		14	14	0%
	2001		4	4	0%
2002		6	6	0%	
2003		28	28	0%	
2004	1	10	11	9%	
ST0002351 Total		13	201	214	6%

Table (a) (3 & 4). # of Tests by Station, % Fail By Station					
Station ID	Model Year	Fail	Pass	Total	% Fail
ST0002358	1984	4	2	6	67%
	1985	1	8	9	11%
	1986	6	8	14	43%
	1987	3	20	23	13%
	1988	4	27	31	13%
	1989	2	30	32	6%
	1990		27	27	0%
	1991	7	27	34	21%
	1992	2	49	51	4%
	1993	8	80	88	9%
	1994	6	97	103	6%
	1995	5	120	125	4%
	1996	23	108	131	18%
	1997	23	148	171	13%
	1998	15	184	199	8%
	1999	18	247	265	7%
	2000	20	370	390	5%
	2001	32	378	410	8%
2002	4	91	95	4%	
2003	14	415	429	3%	
2004	2	29	31	6%	
ST0002358 Total		199	2,465	2,664	7%
ST0002365	1983	3		3	100%
	1984	5	4	9	56%
	1985	5	9	14	36%
	1986	6	25	31	19%
	1987	1	21	22	5%
	1988	4	42	46	9%
	1989	4	58	62	6%
	1990	4	57	61	7%
	1991	7	62	69	10%
	1992	4	73	77	5%
	1993	13	100	113	12%
	1994	8	148	156	5%
	1995	14	197	211	7%
	1996	27	163	190	14%
	1997	27	224	251	11%
	1998	23	270	293	8%
	1999	36	328	364	10%
	2000	49	509	558	9%
2001	35	449	484	7%	
2002	11	130	141	8%	
2003	22	460	482	5%	
2004	2	26	28	7%	
2005		1	1	0%	
ST0002365 Total		310	3,356	3,666	8%

Table (a) (3 & 4). # of Tests by Station, % Fail By Station					
Station ID	Model Year	Fail	Pass	Total	% Fail
ST0002373	1984	5	21	26	19%
	1985	9	36	45	20%
	1986	10	36	46	22%
	1987	4	60	64	6%
	1988	9	73	82	11%
	1989	11	91	102	11%
	1990	11	79	90	12%
	1991	14	87	101	14%
	1992	12	134	146	8%
	1993	14	175	189	7%
	1994	16	213	229	7%
	1995	19	349	368	5%
	1996	43	293	336	13%
	1997	47	369	416	11%
	1998	39	349	388	10%
	1999	38	519	557	7%
	2000	51	770	821	6%
	2001	40	745	785	5%
2002	8	165	173	5%	
2003	21	779	800	3%	
2004		62	62	0%	
ST0002373 Total		421	5,405	5,826	7%
ST0002379	1985	2		2	100%
	1986		8	8	0%
	1987		10	10	0%
	1988		8	8	0%
	1989	2	19	21	10%
	1990	3	10	13	23%
	1991		19	19	0%
	1992		20	20	0%
	1993	1	27	28	4%
	1994	2	51	53	4%
	1995		57	57	0%
	1996	9	45	54	17%
	1997	8	54	62	13%
	1998	8	70	78	10%
	1999	13	78	91	14%
	2000	6	65	71	8%
	2001	3	26	29	10%
	2002		23	23	0%
2003	3	61	64	5%	
2004		7	7	0%	
ST0002379 Total		60	658	718	8%

Table (a) (3 & 4). # of Tests by Station, % Fail By Station					
Station ID	Model Year	Fail	Pass	Total	% Fail
ST0002380	1984		12	12	0%
	1985	4	12	16	25%
	1986	4	21	25	16%
	1987	7	36	43	16%
	1988	11	49	60	18%
	1989	11	39	50	22%
	1990	8	29	37	22%
	1991	5	44	49	10%
	1992	6	61	67	9%
	1993	3	92	95	3%
	1994	8	115	123	7%
	1995	8	146	154	5%
	1996	18	120	138	13%
	1997	21	170	191	11%
	1998	17	151	168	10%
	1999	12	232	244	5%
	2000	18	357	375	5%
2001	20	373	393	5%	
2002	3	92	95	3%	
2003	14	406	420	3%	
2004	2	33	35	6%	
ST0002380 Total		200	2,590	2,790	7%
ST0002419	1983	1		1	100%
	1984	4	7	11	36%
	1985	5	10	15	33%
	1986	8	10	18	44%
	1987	7	28	35	20%
	1988	6	38	44	14%
	1989	11	43	54	20%
	1990	10	38	48	21%
	1991	8	56	64	13%
	1992	7	72	79	9%
	1993	8	95	103	8%
	1994	7	137	144	5%
	1995	9	162	171	5%
	1996	18	141	159	11%
	1997	22	212	234	9%
	1998	14	229	243	6%
	1999	11	332	343	3%
2000	19	493	512	4%	
2001	23	450	473	5%	
2002	5	154	159	3%	
2003	10	537	547	2%	
2004		238	238	0%	
ST0002419 Total		213	3,482	3,695	6%

Table (a) (3 & 4). # of Tests by Station, % Fail By Station					
Station ID	Model Year	Fail	Pass	Total	% Fail
ST0002427	1983	1	3	4	25%
	1984		7	7	0%
	1985	4	11	15	27%
	1986	8	16	24	33%
	1987	6	27	33	18%
	1988	4	50	54	7%
	1989	3	45	48	6%
	1990	6	55	61	10%
	1991	4	48	52	8%
	1992	8	58	66	12%
	1993	7	81	88	8%
	1994	13	108	121	11%
	1995	8	170	178	4%
	1996	5	134	139	4%
	1997	10	222	232	4%
	1998	3	218	221	1%
	1999	9	311	320	3%
	2000	10	366	376	3%
	2001	9	377	386	2%
	2002	2	192	194	1%
2003	5	473	478	1%	
2004	1	361	362	0%	
2006		1	1	0%	
ST0002427 Total		126	3,334	3,460	4%
ST0002493	1984	3	13	16	19%
	1985	3	14	17	18%
	1986	5	17	22	23%
	1987	10	45	55	18%
	1988	5	51	56	9%
	1989	6	71	77	8%
	1990	10	64	74	14%
	1991	11	72	83	13%
	1992	9	100	109	8%
	1993	9	141	150	6%
	1994	19	201	220	9%
	1995	9	286	295	3%
	1996	13	273	286	5%
	1997	36	384	420	9%
	1998	22	437	459	5%
	1999	28	603	631	4%
	2000	42	938	980	4%
2001	37	977	1014	4%	
2002	17	249	266	6%	
2003	15	1053	1068	1%	
2004		98	98	0%	
ST0002493 Total		309	6,087	6,396	5%

Table (a) (3 & 4). # of Tests by Station, % Fail By Station					
Station ID	Model Year	Fail	Pass	Total	% Fail
ST0002526	1983		3	3	0%
	1984		3	3	0%
	1985		9	9	0%
	1986	1	5	6	17%
	1987	1	15	16	6%
	1988	2	20	22	9%
	1989	4	16	20	20%
	1990	5	24	29	17%
	1991	4	33	37	11%
	1992	3	21	24	13%
	1993	2	31	33	6%
	1994	8	51	59	14%
	1995	6	76	82	7%
	1996	8	68	76	11%
	1997	13	102	115	11%
	1998	13	96	109	12%
	1999	14	147	161	9%
	2000	7	142	149	5%
	2001	1	31	32	3%
	2002	4	50	54	7%
2003	5	183	188	3%	
2004		10	10	0%	
ST0002526 Total		101	1,136	1,237	8%
ST0002540	1984	1	2	3	33%
	1985		1	1	0%
	1986		9	9	0%
	1987	1	13	14	7%
	1988	1	15	16	6%
	1989	2	13	15	13%
	1990	2	15	17	12%
	1991	5	10	15	33%
	1992	2	18	20	10%
	1993		22	22	0%
	1994	3	36	39	8%
	1995	3	43	46	7%
	1996	5	41	46	11%
	1997	5	49	54	9%
	1998	6	67	73	8%
	1999	4	80	84	5%
	2000	17	193	210	8%
	2001	19	320	339	6%
	2002	5	46	51	10%
	2003	3	251	254	1%
2004		28	28	0%	
2006		1	1	0%	
ST0002540 Total		84	1,273	1,357	6%

Table (a) (3 & 4). # of Tests by Station, % Fail By Station					
Station ID	Model Year	Fail	Pass	Total	% Fail
ST0002554	1983		3	3	0%
	1984	1	5	6	17%
	1985	3	5	8	38%
	1986		6	6	0%
	1987	2	15	17	12%
	1988	4	19	23	17%
	1989	1	26	27	4%
	1990	3	19	22	14%
	1991	2	27	29	7%
	1992	4	25	29	14%
	1993	3	40	43	7%
	1994	5	47	52	10%
	1995	5	68	73	7%
	1996	4	66	70	6%
	1997	3	91	94	3%
	1998	7	83	90	8%
	1999	10	121	131	8%
	2000	3	156	159	2%
	2001		28	28	0%
	2002	5	32	37	14%
2003	3	139	142	2%	
2004		3	3	0%	
ST0002554 Total		68	1,024	1,092	6%
ST0002560	1984	3	7	10	30%
	1985	2	17	19	11%
	1986	5	18	23	22%
	1987	4	34	38	11%
	1988	5	32	37	14%
	1989	3	45	48	6%
	1990	9	61	70	13%
	1991	13	60	73	18%
	1992	6	98	104	6%
	1993	8	115	123	7%
	1994	10	189	199	5%
	1995	15	228	243	6%
	1996	33	210	243	14%
	1997	31	293	324	10%
	1998	30	314	344	9%
	1999	43	504	547	8%
	2000	51	746	797	6%
	2001	45	826	871	5%
	2002	10	188	198	5%
	2003	15	941	956	2%
2004		323	323	0%	
ST0002560 Total		341	5,249	5,590	6%

Table (a) (3 & 4). # of Tests by Station, % Fail By Station					
Station ID	Model Year	Fail	Pass	Total	% Fail
ST0002573	1983		1	1	0%
	1984	2	7	9	22%
	1985	2	7	9	22%
	1986	1	10	11	9%
	1987	1	22	23	4%
	1988	5	27	32	16%
	1989	2	27	29	7%
	1990	5	30	35	14%
	1991	5	42	47	11%
	1992	7	40	47	15%
	1993	10	67	77	13%
	1994	3	80	83	4%
	1995	6	114	120	5%
	1996	17	99	116	15%
	1997	11	155	166	7%
	1998	16	121	137	12%
	1999	15	217	232	6%
	2000	11	201	212	5%
	2001	6	67	73	8%
	2002	6	94	100	6%
2003	9	299	308	3%	
2004		68	68	0%	
ST0002573 Total		140	1,795	1,935	7%
ST0002593	1983		1	1	0%
	1984		3	3	0%
	1985	2	6	8	25%
	1986	4	20	24	17%
	1987	5	31	36	14%
	1988	3	32	35	9%
	1989	2	49	51	4%
	1990	8	37	45	18%
	1991	6	38	44	14%
	1992	8	65	73	11%
	1993	10	78	88	11%
	1994	13	108	121	11%
	1995	11	140	151	7%
	1996	21	125	146	14%
	1997	20	210	230	9%
	1998	25	206	231	11%
	1999	10	246	256	4%
	2000	23	386	409	6%
	2001	16	318	334	5%
	2002	9	107	116	8%
2003	1	379	380	0%	
2004	1	33	34	3%	
ST0002593 Total		198	2,618	2,816	7%

Table (a) (3 & 4). # of Tests by Station, % Fail By Station					
Station ID	Model Year	Fail	Pass	Total	% Fail
ST0002603	1984	1	3	4	25%
	1985	1	3	4	25%
	1986	1	7	8	13%
	1987	5	10	15	33%
	1988	2	11	13	15%
	1989	3	16	19	16%
	1990	2	12	14	14%
	1991		30	30	0%
	1992	11	29	40	28%
	1993	6	45	51	12%
	1994	11	55	66	17%
	1995	8	84	92	9%
	1996	10	85	95	11%
	1997	11	106	117	9%
	1998	11	118	129	9%
	1999	20	167	187	11%
	2000	14	257	271	5%
2001	20	242	262	8%	
2002	8	65	73	11%	
2003	9	302	311	3%	
2004		30	30	0%	
ST0002603 Total		154	1,677	1,831	8%
ST0002631	1983		1	1	0%
	1984	1	5	6	17%
	1985	4	9	13	31%
	1986	4	15	19	21%
	1987	7	32	39	18%
	1988	5	38	43	12%
	1989	4	33	37	11%
	1990	3	44	47	6%
	1991	3	35	38	8%
	1992	1	45	46	2%
	1993	11	56	67	16%
	1994	3	98	101	3%
	1995	12	130	142	8%
	1996	15	119	134	11%
	1997	13	169	182	7%
	1998	21	184	205	10%
	1999	18	254	272	7%
2000	29	371	400	7%	
2001	17	326	343	5%	
2002	9	83	92	10%	
2003	6	345	351	2%	
2004		18	18	0%	
ST0002631 Total		186	2,410	2,596	7%

Table (a) (3 & 4). # of Tests by Station, % Fail By Station					
Station ID	Model Year	Fail	Pass	Total	% Fail
ST0002651	1984	4	3	7	57%
	1985	2	8	10	20%
	1986	7	16	23	30%
	1987	2	27	29	7%
	1988	6	33	39	15%
	1989	7	33	40	18%
	1990	1	27	28	4%
	1991	1	35	36	3%
	1992	3	40	43	7%
	1993	4	68	72	6%
	1994	4	83	87	5%
	1995	7	94	101	7%
	1996	13	96	109	12%
	1997	11	130	141	8%
	1998	7	121	128	5%
	1999	12	171	183	7%
	2000	10	244	254	4%
	2001	16	186	202	8%
2002	3	56	59	5%	
2003	4	241	245	2%	
2004	1	16	17	6%	
ST0002651 Total		125	1,728	1,853	7%
ST0002652	1983		3	3	0%
	1984	4	13	17	24%
	1985	4	13	17	24%
	1986	13	32	45	29%
	1987	6	40	46	13%
	1988	8	57	65	12%
	1989	10	74	84	12%
	1990	9	68	77	12%
	1991	13	88	101	13%
	1992	17	105	122	14%
	1993	9	138	147	6%
	1994	8	225	233	3%
	1995	4	249	253	2%
	1996	29	247	276	11%
	1997	34	321	355	10%
	1998	34	348	382	9%
	1999	36	439	475	8%
	2000	38	771	809	5%
2001	43	688	731	6%	
2002	10	137	147	7%	
2003	16	714	730	2%	
2004	1	53	54	2%	
ST0002652 Total		346	4,823	5,169	7%

Table (a) (3 & 4). # of Tests by Station, % Fail By Station					
Station ID	Model Year	Fail	Pass	Total	% Fail
ST0002672	1983	2	6	8	25%
	1984	2	17	19	11%
	1985	3	16	19	16%
	1986	13	33	46	28%
	1987	13	51	64	20%
	1988	8	70	78	10%
	1989	14	101	115	12%
	1990	6	90	96	6%
	1991	7	102	109	6%
	1992	15	129	144	10%
	1993	20	196	216	9%
	1994	18	276	294	6%
	1995	22	359	381	6%
	1996	46	366	412	11%
	1997	65	496	561	12%
	1998	53	529	582	9%
	1999	54	719	773	7%
	2000	66	1209	1275	5%
	2001	90	1166	1256	7%
	2002	23	304	327	7%
2003	45	1367	1412	3%	
2004	1	178	179	1%	
ST0002672 Total		586	7,780	8,366	7%
ST0002722	1984	1	6	7	14%
	1985	1	9	10	10%
	1986	4	19	23	17%
	1987	4	19	23	17%
	1988	7	27	34	21%
	1989	4	37	41	10%
	1990	5	37	42	12%
	1991	9	58	67	13%
	1992	3	59	62	5%
	1993	8	88	96	8%
	1994	14	103	117	12%
	1995	5	159	164	3%
	1996	15	154	169	9%
	1997	20	210	230	9%
	1998	23	212	235	10%
	1999	17	336	353	5%
	2000	32	491	523	6%
	2001	29	465	494	6%
	2002	5	130	135	4%
	2003	14	571	585	2%
2004	1	43	44	2%	
ST0002722 Total		221	3,233	3,454	6%

Table (a) (3 & 4). # of Tests by Station, % Fail By Station					
Station ID	Model Year	Fail	Pass	Total	% Fail
ST0002740	1983		1	1	0%
	1984	5	10	15	33%
	1985	4	16	20	20%
	1986	2	18	20	10%
	1987	4	35	39	10%
	1988	6	36	42	14%
	1989	3	44	47	6%
	1990	10	40	50	20%
	1991	8	53	61	13%
	1992	9	95	104	9%
	1993	12	113	125	10%
	1994	16	143	159	10%
	1995	10	226	236	4%
	1996	37	161	198	19%
	1997	33	261	294	11%
	1998	30	268	298	10%
	1999	31	405	436	7%
	2000	47	608	655	7%
	2001	41	608	649	6%
	2002	13	138	151	9%
2003	27	720	747	4%	
2004	2	55	57	4%	
ST0002740 Total		350	4,054	4,404	8%
ST0002744	1983	1	1	2	50%
	1984	8	16	24	33%
	1985	8	22	30	27%
	1986	9	36	45	20%
	1987	5	40	45	11%
	1988	16	74	90	18%
	1989	12	91	103	12%
	1990	12	75	87	14%
	1991	5	90	95	5%
	1992	13	125	138	9%
	1993	14	160	174	8%
	1994	14	211	225	6%
	1995	24	288	312	8%
	1996	28	270	298	9%
	1997	38	375	413	9%
	1998	33	371	404	8%
	1999	37	486	523	7%
	2000	29	828	857	3%
	2001	47	786	833	6%
	2002	10	209	219	5%
2003	19	826	845	2%	
2004	2	115	117	2%	
ST0002744 Total		384	5,495	5,879	7%

Table (a) (3 & 4). # of Tests by Station, % Fail By Station					
Station ID	Model Year	Fail	Pass	Total	% Fail
ST0002770	1984	1	3	4	25%
	1985	2	5	7	29%
	1986	3	11	14	21%
	1987	1	7	8	13%
	1988	7	24	31	23%
	1989	2	17	19	11%
	1990	2	25	27	7%
	1991	3	35	38	8%
	1992	5	47	52	10%
	1993	2	50	52	4%
	1994	8	69	77	10%
	1995	4	103	107	4%
	1996	20	103	123	16%
	1997	19	131	150	13%
	1998	14	132	146	10%
	1999	14	196	210	7%
	2000	23	329	352	7%
	2001	24	248	272	9%
2002	6	68	74	8%	
2003	15	348	363	4%	
2004	4	17	21	19%	
ST0002770 Total		179	1,968	2,147	8%
ST0002822	1983		4	4	0%
	1984	7	19	26	27%
	1985	11	22	33	33%
	1986	13	37	50	26%
	1987	16	42	58	28%
	1988	14	79	93	15%
	1989	11	95	106	10%
	1990	15	83	98	15%
	1991	15	111	126	12%
	1992	20	148	168	12%
	1993	23	202	225	10%
	1994	16	255	271	6%
	1995	21	351	372	6%
	1996	52	268	320	16%
	1997	41	387	428	10%
	1998	32	366	398	8%
	1999	31	506	537	6%
	2000	54	776	830	7%
2001	30	698	728	4%	
2002	12	254	266	5%	
2003	26	824	850	3%	
2004	3	171	174	2%	
ST0002822 Total		463	5,698	6,161	8%

Table (a) (3 & 4). # of Tests by Station, % Fail By Station					
Station ID	Model Year	Fail	Pass	Total	% Fail
ST0002830	1983		1	1	0%
	1984	1	5	6	17%
	1985	2	16	18	11%
	1986	1	18	19	5%
	1987	6	30	36	17%
	1988	8	36	44	18%
	1989	6	41	47	13%
	1990	5	46	51	10%
	1991	5	59	64	8%
	1992	3	76	79	4%
	1993	7	105	112	6%
	1994	11	130	141	8%
	1995	11	187	198	6%
	1996	19	153	172	11%
	1997	31	241	272	11%
	1998	27	221	248	11%
	1999	22	311	333	7%
	2000	26	507	533	5%
	2001	27	481	508	5%
	2002	5	125	130	4%
2003	19	479	498	4%	
2004		72	72	0%	
ST0002830 Total		242	3,340	3,582	7%
ST0002880	1983	3	5	8	38%
	1984	4	14	18	22%
	1985	4	19	23	17%
	1986	9	38	47	19%
	1987	8	54	62	13%
	1988	7	71	78	9%
	1989	5	90	95	5%
	1990	7	75	82	9%
	1991	14	116	130	11%
	1992	10	130	140	7%
	1993	11	175	186	6%
	1994	16	244	260	6%
	1995	13	317	330	4%
	1996	33	269	302	11%
	1997	41	374	415	10%
	1998	28	326	354	8%
	1999	38	477	515	7%
	2000	43	752	795	5%
	2001	44	695	739	6%
	2002	11	169	180	6%
2003	29	795	824	4%	
2004		67	67	0%	
ST0002880 Total		378	5,272	5,650	7%

Table (a) (3 & 4). # of Tests by Station, % Fail By Station					
Station ID	Model Year	Fail	Pass	Total	% Fail
ST0002884	1983		3	3	0%
	1984	4	9	13	31%
	1985	1	13	14	7%
	1986	4	23	27	15%
	1987	4	33	37	11%
	1988	7	44	51	14%
	1989	5	58	63	8%
	1990	3	64	67	4%
	1991	6	63	69	9%
	1992	5	74	79	6%
	1993	5	105	110	5%
	1994	16	151	167	10%
	1995	15	188	203	7%
	1996	18	173	191	9%
	1997	22	267	289	8%
	1998	13	277	290	4%
	1999	15	352	367	4%
	2000	30	547	577	5%
	2001	29	505	534	5%
	2002	4	126	130	3%
2003	19	544	563	3%	
2004		42	42	0%	
ST0002884 Total		225	3,661	3,886	6%
ST0002903	1982		1	1	0%
	1983		1	1	0%
	1984	3	9	12	25%
	1985	6	15	21	29%
	1986	2	24	26	8%
	1987	4	19	23	17%
	1988	6	28	34	18%
	1989	6	24	30	20%
	1990	6	36	42	14%
	1991	1	44	45	2%
	1992	4	71	75	5%
	1993	10	82	92	11%
	1994	6	106	112	5%
	1995	15	137	152	10%
	1996	24	116	140	17%
	1997	16	169	185	9%
	1998	20	188	208	10%
	1999	17	209	226	8%
	2000	19	325	344	6%
	2001	21	289	310	7%
2002	5	87	92	5%	
2003	5	304	309	2%	
2004		61	61	0%	
2006		1	1	0%	
ST0002903 Total		196	2,346	2,542	8%

Table (a) (3 & 4). # of Tests by Station, % Fail By Station					
Station ID	Model Year	Fail	Pass	Total	% Fail
ST0002915	1983		1	1	0%
	1984	3	10	13	23%
	1985	4	19	23	17%
	1986	8	31	39	21%
	1987	4	48	52	8%
	1988	13	50	63	21%
	1989	9	65	74	12%
	1990	5	82	87	6%
	1991	5	72	77	6%
	1992	10	101	111	9%
	1993	13	181	194	7%
	1994	9	205	214	4%
	1995	15	274	289	5%
	1996	28	235	263	11%
	1997	37	353	390	9%
	1998	37	385	422	9%
	1999	37	457	494	7%
	2000	45	770	815	6%
	2001	39	713	752	5%
	2002	10	216	226	4%
2003	30	786	816	4%	
2004	3	118	121	2%	
ST0002915 Total		364	5,172	5,536	7%
ST0002919	1983	1		1	100%
	1984	1	2	3	33%
	1985	1	4	5	20%
	1986	3	5	8	38%
	1987	6	6	12	50%
	1988	2	19	21	10%
	1989	4	21	25	16%
	1990	2	33	35	6%
	1991	3	23	26	12%
	1992	7	24	31	23%
	1993	7	60	67	10%
	1994	7	70	77	9%
	1995	8	95	103	8%
	1996	13	96	109	12%
	1997	10	118	128	8%
	1998	19	109	128	15%
	1999	19	184	203	9%
	2000	19	231	250	8%
	2001	12	201	213	6%
	2002	6	83	89	7%
2003	9	221	230	4%	
2004		29	29	0%	
ST0002919 Total		159	1,634	1,793	9%

Table (a) (3 & 4). # of Tests by Station, % Fail By Station					
Station ID	Model Year	Fail	Pass	Total	% Fail
ST0002955	1983		3	3	0%
	1984	1	3	4	25%
	1985	6	4	10	60%
	1986	4	9	13	31%
	1987	7	10	17	41%
	1988	6	19	25	24%
	1989	6	25	31	19%
	1990	8	33	41	20%
	1991	7	31	38	18%
	1992	8	52	60	13%
	1993	5	74	79	6%
	1994	14	90	104	13%
	1995	13	127	140	9%
	1996	31	85	116	27%
	1997	27	126	153	18%
	1998	19	110	129	15%
	1999	27	151	178	15%
	2000	25	166	191	13%
	2001	8	163	171	5%
	2002	4	62	66	6%
2003	6	108	114	5%	
2004		11	11	0%	
2006		1	1	0%	
ST0002955 Total		232	1,463	1,695	14%
ST0002964	1984	3	8	11	27%
	1985	6	17	23	26%
	1986	8	25	33	24%
	1987	7	40	47	15%
	1988	9	49	58	16%
	1989	8	66	74	11%
	1990	13	66	79	16%
	1991	7	62	69	10%
	1992	11	111	122	9%
	1993	11	172	183	6%
	1994	20	191	211	9%
	1995	13	275	288	5%
	1996	37	253	290	13%
	1997	47	358	405	12%
	1998	42	337	379	11%
	1999	45	452	497	9%
	2000	54	687	741	7%
2001	52	663	715	7%	
2002	9	201	210	4%	
2003	18	769	787	2%	
2004	6	151	157	4%	
ST0002964 Total		426	4,953	5,379	8%

Table (a) (3 & 4). # of Tests by Station, % Fail By Station					
Station ID	Model Year	Fail	Pass	Total	% Fail
ST0003004	1983		3	3	0%
	1984	3	8	11	27%
	1985	5	22	27	19%
	1986	6	22	28	21%
	1987	12	28	40	30%
	1988	7	52	59	12%
	1989	8	68	76	11%
	1990	10	52	62	16%
	1991	15	73	88	17%
	1992	13	90	103	13%
	1993	13	135	148	9%
	1994	14	203	217	6%
	1995	10	242	252	4%
	1996	26	201	227	11%
	1997	30	277	307	10%
	1998	27	317	344	8%
	1999	30	329	359	8%
	2000	19	502	521	4%
	2001	25	441	466	5%
2002	6	190	196	3%	
2003	11	407	418	3%	
2004	1	199	200	1%	
ST0003004 Total		291	3,861	4,152	7%
ST0003086	1984	1	6	7	14%
	1985	4	2	6	67%
	1986	3	13	16	19%
	1987	1	20	21	5%
	1988	6	13	19	32%
	1989	4	27	31	13%
	1990	4	38	42	10%
	1991	6	30	36	17%
	1992	3	38	41	7%
	1993	5	48	53	9%
	1994	4	77	81	5%
	1995	9	102	111	8%
	1996	15	79	94	16%
	1997	11	99	110	10%
	1998	15	117	132	11%
	1999	15	141	156	10%
	2000	16	218	234	7%
	2001	12	181	193	6%
	2002	2	63	65	3%
2003	10	222	232	4%	
2004	1	34	35	3%	
ST0003086 Total		147	1,568	1,715	9%

Table (a) (3 & 4). # of Tests by Station, % Fail By Station					
Station ID	Model Year	Fail	Pass	Total	% Fail
ST0003102	1983		1	1	0%
	1984		2	2	0%
	1985	2	4	6	33%
	1986	1	12	13	8%
	1987	3	18	21	14%
	1988	4	19	23	17%
	1989	8	23	31	26%
	1990	8	30	38	21%
	1991	8	37	45	18%
	1992	4	56	60	7%
	1993	13	88	101	13%
	1994	14	86	100	14%
	1995	13	150	163	8%
	1996	29	119	148	20%
	1997	25	141	166	15%
	1998	26	162	188	14%
	1999	26	199	225	12%
	2000	35	234	269	13%
	2001	23	230	253	9%
	2002	11	80	91	12%
2003	8	251	259	3%	
2004		26	26	0%	
ST0003102 Total		261	1,968	2,229	12%
ST0003106	1983		1	1	0%
	1984	2	4	6	33%
	1985	2	6	8	25%
	1986	5	8	13	38%
	1987	6	14	20	30%
	1988	5	15	20	25%
	1989	4	21	25	16%
	1990	6	26	32	19%
	1991	5	35	40	13%
	1992	5	42	47	11%
	1993	1	63	64	2%
	1994	5	87	92	5%
	1995	11	119	130	8%
	1996	16	77	93	17%
	1997	21	119	140	15%
	1998	12	132	144	8%
	1999	12	132	144	8%
	2000	10	206	216	5%
	2001	14	192	206	7%
	2002	3	60	63	5%
2003	5	195	200	3%	
2004		14	14	0%	
ST0003106 Total		150	1,568	1,718	9%

Table (a) (3 & 4). # of Tests by Station, % Fail By Station					
Station ID	Model Year	Fail	Pass	Total	% Fail
ST0003107	1983	1		1	100%
	1984	6	9	15	40%
	1985	7	13	20	35%
	1986	8	30	38	21%
	1987	11	31	42	26%
	1988	11	60	71	15%
	1989	25	58	83	30%
	1990	10	69	79	13%
	1991	11	64	75	15%
	1992	13	104	117	11%
	1993	17	149	166	10%
	1994	23	172	195	12%
	1995	12	246	258	5%
	1996	42	197	239	18%
	1997	36	265	301	12%
	1998	26	250	276	9%
	1999	46	312	358	13%
	2000	39	462	501	8%
2001	37	402	439	8%	
2002	12	131	143	8%	
2003	17	399	416	4%	
2004		39	39	0%	
ST0003107 Total		410	3,462	3,872	11%
ST0003176	1984	5	6	11	45%
	1985	5	7	12	42%
	1986	11	18	29	38%
	1987	4	26	30	13%
	1988	5	42	47	11%
	1989	10	33	43	23%
	1990	6	46	52	12%
	1991	8	58	66	12%
	1992	13	87	100	13%
	1993	15	94	109	14%
	1994	13	125	138	9%
	1995	15	215	230	7%
	1996	41	148	189	22%
	1997	44	239	283	16%
	1998	31	231	262	12%
	1999	34	336	370	9%
	2000	54	488	542	10%
	2001	29	401	430	7%
2002	14	139	153	9%	
2003	25	411	436	6%	
2004		37	37	0%	
ST0003176 Total		382	3,187	3,569	11%

Table (a) (3 & 4). # of Tests by Station, % Fail By Station					
Station ID	Model Year	Fail	Pass	Total	% Fail
ST0003190	1983		2	2	0%
	1984	4	8	12	33%
	1985	1	11	12	8%
	1986	3	23	26	12%
	1987	4	25	29	14%
	1988	6	33	39	15%
	1989	6	58	64	9%
	1990	8	51	59	14%
	1991	9	86	95	9%
	1992	6	85	91	7%
	1993	14	141	155	9%
	1994	8	188	196	4%
	1995	13	252	265	5%
	1996	27	217	244	11%
	1997	37	349	386	10%
	1998	32	368	400	8%
	1999	32	544	576	6%
	2000	33	852	885	4%
	2001	51	870	921	6%
2002	5	245	250	2%	
2003	6	1176	1182	1%	
2004	2	81	83	2%	
ST0003190 Total		307	5,665	5,972	5%
ST0003192	1983	2	9	11	18%
	1984	12	35	47	26%
	1985	17	56	73	23%
	1986	18	70	88	20%
	1987	20	98	118	17%
	1988	35	117	152	23%
	1989	27	152	179	15%
	1990	33	198	231	14%
	1991	31	214	245	13%
	1992	33	250	283	12%
	1993	52	383	435	12%
	1994	52	546	598	9%
	1995	62	728	790	8%
	1996	103	667	770	13%
	1997	132	825	957	14%
	1998	128	869	997	13%
	1999	93	1162	1255	7%
	2000	104	1533	1637	6%
	2001	96	1297	1393	7%
2002	46	669	715	6%	
2003	39	1345	1384	3%	
2004	6	456	462	1%	
ST0003192 Total		1,141	11,679	12,820	9%

Table (a) (3 & 4). # of Tests by Station, % Fail By Station					
Station ID	Model Year	Fail	Pass	Total	% Fail
ST0003225	1983		2	2	0%
	1984	1	4	5	20%
	1985	6	8	14	43%
	1986	3	9	12	25%
	1987	8	12	20	40%
	1988	7	18	25	28%
	1989	7	27	34	21%
	1990	20	32	52	38%
	1991	12	38	50	24%
	1992	17	67	84	20%
	1993	24	90	114	21%
	1994	23	110	133	17%
	1995	17	149	166	10%
	1996	52	113	165	32%
	1997	57	140	197	29%
	1998	29	144	173	17%
	1999	27	131	158	17%
	2000	31	224	255	12%
	2001	25	167	192	13%
2002	7	79	86	8%	
2003	10	120	130	8%	
2004	4	34	38	11%	
ST0003225 Total		387	1,718	2,105	18%
ST0003253	1983		1	1	0%
	1984		7	7	0%
	1985		8	8	0%
	1986	5	8	13	38%
	1987	6	22	28	21%
	1988	1	20	21	5%
	1989	4	20	24	17%
	1990	1	21	22	5%
	1991	5	22	27	19%
	1992	7	39	46	15%
	1993	2	55	57	4%
	1994	3	69	72	4%
	1995	4	105	109	4%
	1996	15	97	112	13%
	1997	11	133	144	8%
	1998	12	169	181	7%
	1999	17	242	259	7%
	2000	15	419	434	3%
	2001	12	422	434	3%
2002	3	118	121	2%	
2003	7	464	471	1%	
2004		75	75	0%	
ST0003253 Total		130	2,536	2,666	5%

Table (a) (3 & 4). # of Tests by Station, % Fail By Station					
Station ID	Model Year	Fail	Pass	Total	% Fail
ST0003263	1983		1	1	0%
	1984		5	5	0%
	1985	2	9	11	18%
	1986	4	7	11	36%
	1987	1	13	14	7%
	1988	5	18	23	22%
	1989	5	25	30	17%
	1990	4	27	31	13%
	1991	3	36	39	8%
	1992	6	57	63	10%
	1993	4	78	82	5%
	1994	6	105	111	5%
	1995	8	124	132	6%
	1996	24	105	129	19%
	1997	25	172	197	13%
	1998	21	164	185	11%
	1999	13	219	232	6%
	2000	43	361	404	11%
	2001	25	321	346	7%
	2002	10	100	110	9%
2003	9	319	328	3%	
2004	1	28	29	3%	
ST0003263 Total		219	2,294	2,513	9%
ST0003292	1983	2	1	3	67%
	1984	4	7	11	36%
	1985	8	16	24	33%
	1986	7	20	27	26%
	1987	7	38	45	16%
	1988	6	40	46	13%
	1989	14	65	79	18%
	1990	8	58	66	12%
	1991	12	74	86	14%
	1992	14	100	114	12%
	1993	14	145	159	9%
	1994	22	205	227	10%
	1995	17	265	282	6%
	1996	34	196	230	15%
	1997	50	242	292	17%
	1998	44	202	246	18%
	1999	42	329	371	11%
	2000	47	449	496	9%
	2001	45	352	397	11%
	2002	13	110	123	11%
2003	22	385	407	5%	
2004	2	40	42	5%	
ST0003292 Total		434	3,339	3,773	12%

Table (a) (3 & 4). # of Tests by Station, % Fail By Station					
Station ID	Model Year	Fail	Pass	Total	% Fail
ST0003406	1983	1	2	3	33%
	1984	11	5	16	69%
	1985	5	19	24	21%
	1986	12	26	38	32%
	1987	16	43	59	27%
	1988	12	51	63	19%
	1989	20	65	85	24%
	1990	17	84	101	17%
	1991	20	118	138	14%
	1992	31	144	175	18%
	1993	31	210	241	13%
	1994	25	249	274	9%
	1995	26	307	333	8%
	1996	67	227	294	23%
	1997	54	289	343	16%
	1998	40	268	308	13%
	1999	34	280	314	11%
	2000	47	340	387	12%
2001	22	231	253	9%	
2002	9	130	139	6%	
2003	9	188	197	5%	
2004	2	40	42	5%	
ST0003406 Total		511	3,316	3,827	13%
ST0003432	1982		1	1	0%
	1983	1	4	5	20%
	1984	4	18	22	18%
	1985	8	21	29	28%
	1986	10	41	51	20%
	1987	16	53	69	23%
	1988	26	85	111	23%
	1989	25	120	145	17%
	1990	26	138	164	16%
	1991	36	155	191	19%
	1992	37	227	264	14%
	1993	41	311	352	12%
	1994	34	426	460	7%
	1995	33	509	542	6%
	1996	94	362	456	21%
	1997	125	400	525	24%
	1998	84	456	540	16%
	1999	79	514	593	13%
2000	74	705	779	9%	
2001	63	577	640	10%	
2002	33	325	358	9%	
2003	37	533	570	6%	
2004	6	184	190	3%	
ST0003432 Total		892	6,165	7,057	13%

Table (a) (3 & 4). # of Tests by Station, % Fail By Station					
Station ID	Model Year	Fail	Pass	Total	% Fail
ST0003437	1984	2	8	10	20%
	1985	2	11	13	15%
	1986	4	13	17	24%
	1987	8	33	41	20%
	1988	5	31	36	14%
	1989	7	39	46	15%
	1990	6	60	66	9%
	1991	2	58	60	3%
	1992	8	88	96	8%
	1993	13	98	111	12%
	1994	12	143	155	8%
	1995	16	196	212	8%
	1996	33	175	208	16%
	1997	30	255	285	11%
	1998	29	288	317	9%
	1999	38	408	446	9%
	2000	40	665	705	6%
2001	73	616	689	11%	
2002	13	168	181	7%	
2003	25	842	867	3%	
2004	1	69	70	1%	
ST0003437 Total		367	4,264	4,631	8%
ST0003449	1983	3	2	5	60%
	1984	4	11	15	27%
	1985	7	20	27	26%
	1986	15	29	44	34%
	1987	17	50	67	25%
	1988	20	89	109	18%
	1989	23	128	151	15%
	1990	31	142	173	18%
	1991	31	181	212	15%
	1992	39	258	297	13%
	1993	43	357	400	11%
	1994	52	480	532	10%
	1995	50	618	668	7%
	1996	161	479	640	25%
	1997	181	692	873	21%
	1998	155	636	791	20%
	1999	116	781	897	13%
2000	134	1093	1227	11%	
2001	113	915	1028	11%	
2002	48	473	521	9%	
2003	40	747	787	5%	
2004	4	217	221	2%	
ST0003449 Total		1,287	8,398	9,685	13%

Table (a) (3 & 4). # of Tests by Station, % Fail By Station					
Station ID	Model Year	Fail	Pass	Total	% Fail
ST0003458	1983	1	4	5	20%
	1984	1	16	17	6%
	1985	1	25	26	4%
	1986	3	37	40	8%
	1987	4	42	46	9%
	1988	12	44	56	21%
	1989	6	67	73	8%
	1990	3	63	66	5%
	1991	5	68	73	7%
	1992	7	81	88	8%
	1993	7	117	124	6%
	1994	12	175	187	6%
	1995	10	221	231	4%
	1996	21	253	274	8%
	1997	17	355	372	5%
	1998	24	394	418	6%
	1999	27	484	511	5%
	2000	35	791	826	4%
	2001	42	883	925	5%
	2002	7	186	193	4%
2003	22	963	985	2%	
2004	1	75	76	1%	
ST0003458 Total		268	5,344	5,612	5%
ST0003483	1983		2	2	0%
	1984	2	5	7	29%
	1985	3	8	11	27%
	1986	3	21	24	13%
	1987	6	23	29	21%
	1988	9	36	45	20%
	1989	4	48	52	8%
	1990	2	57	59	3%
	1991	8	52	60	13%
	1992	7	87	94	7%
	1993	8	99	107	7%
	1994	9	119	128	7%
	1995	12	147	159	8%
	1996	16	129	145	11%
	1997	23	202	225	10%
	1998	21	165	186	11%
	1999	25	273	298	8%
	2000	34	382	416	8%
	2001	32	400	432	7%
	2002	10	93	103	10%
2003	26	485	511	5%	
2004		47	47	0%	
ST0003483 Total		260	2,880	3,140	8%

Table (a) (3 & 4). # of Tests by Station, % Fail By Station					
Station ID	Model Year	Fail	Pass	Total	% Fail
ST0003498	1983	1	1	2	50%
	1984	8	14	22	36%
	1985	8	24	32	25%
	1986	7	30	37	19%
	1987	11	62	73	15%
	1988	12	84	96	13%
	1989	21	115	136	15%
	1990	27	105	132	20%
	1991	21	148	169	12%
	1992	27	158	185	15%
	1993	29	254	283	10%
	1994	49	367	416	12%
	1995	38	475	513	7%
	1996	68	375	443	15%
	1997	65	466	531	12%
	1998	72	453	525	14%
	1999	58	573	631	9%
	2000	68	745	813	8%
	2001	56	646	702	8%
2002	12	226	238	5%	
2003	21	620	641	3%	
2004	1	121	122	1%	
ST0003498 Total		680	6,062	6,742	10%
ST0003548	1983		4	4	0%
	1984	7	20	27	26%
	1985	17	33	50	34%
	1986	20	51	71	28%
	1987	20	68	88	23%
	1988	28	122	150	19%
	1989	33	159	192	17%
	1990	27	197	224	12%
	1991	27	175	202	13%
	1992	44	230	274	16%
	1993	37	368	405	9%
	1994	49	494	543	9%
	1995	44	625	669	7%
	1996	82	508	590	14%
	1997	112	687	799	14%
	1998	89	705	794	11%
	1999	67	850	917	7%
	2000	72	1103	1175	6%
	2001	82	911	993	8%
2002	34	354	388	9%	
2003	27	988	1015	3%	
2004	4	273	277	1%	
ST0003548 Total		922	8,925	9,847	9%

Table (a) (3 & 4). # of Tests by Station, % Fail By Station					
Station ID	Model Year	Fail	Pass	Total	% Fail
ST0003592	1983	1	3	4	25%
	1984	5	16	21	24%
	1985	10	27	37	27%
	1986	11	29	40	28%
	1987	9	54	63	14%
	1988	11	69	80	14%
	1989	17	92	109	16%
	1990	10	97	107	9%
	1991	11	103	114	10%
	1992	17	181	198	9%
	1993	18	214	232	8%
	1994	18	336	354	5%
	1995	26	464	490	5%
	1996	62	370	432	14%
	1997	60	566	626	10%
	1998	50	490	540	9%
	1999	58	720	778	7%
	2000	79	937	1016	8%
	2001	61	800	861	7%
	2002	18	267	285	6%
2003	25	890	915	3%	
2004	5	99	104	5%	
ST0003592 Total		582	6,824	7,406	8%
ST0003662	1983		8	8	0%
	1984	5	7	12	42%
	1985	9	21	30	30%
	1986	8	17	25	32%
	1987	5	43	48	10%
	1988	13	59	72	18%
	1989	14	76	90	16%
	1990	16	99	115	14%
	1991	20	110	130	15%
	1992	14	140	154	9%
	1993	22	147	169	13%
	1994	25	230	255	10%
	1995	24	305	329	7%
	1996	43	295	338	13%
	1997	23	336	359	6%
	1998	26	338	364	7%
	1999	32	435	467	7%
	2000	28	625	653	4%
	2001	22	545	567	4%
	2002	12	283	295	4%
2003	8	751	759	1%	
2004	3	414	417	1%	
ST0003662 Total		372	5,284	5,656	7%

Table (a) (3 & 4). # of Tests by Station, % Fail By Station					
Station ID	Model Year	Fail	Pass	Total	% Fail
ST0003724	1983		1	1	0%
	1984	2	11	13	15%
	1985	1	10	11	9%
	1986	2	19	21	10%
	1987	2	19	21	10%
	1988	5	20	25	20%
	1989	3	34	37	8%
	1990	3	18	21	14%
	1991	3	34	37	8%
	1992	2	36	38	5%
	1993	3	65	68	4%
	1994	4	94	98	4%
	1995	2	98	100	2%
	1996	9	102	111	8%
	1997	9	132	141	6%
	1998	8	113	121	7%
	1999	5	170	175	3%
	2000	10	250	260	4%
	2001	5	248	253	2%
	2002	3	65	68	4%
2003	7	258	265	3%	
2004		14	14	0%	
ST0003724 Total		88	1,811	1,899	5%
ST0003732	1984	2	2	4	50%
	1985	2		2	100%
	1986	2	7	9	22%
	1987	4	3	7	57%
	1988	2	2	4	50%
	1989	2	11	13	15%
	1990		12	12	0%
	1991		8	8	0%
	1992		11	11	0%
	1993		17	17	0%
	1994	1	26	27	4%
	1995	3	38	41	7%
	1996	11	30	41	27%
	1997		42	42	0%
	1998	3	39	42	7%
	1999	4	52	56	7%
	2000	7	91	98	7%
	2001	2	76	78	3%
	2002	1	15	16	6%
	2003	4	95	99	4%
2004		4	4	0%	
ST0003732 Total		50	581	631	8%

Table (a) (3 & 4). # of Tests by Station, % Fail By Station					
Station ID	Model Year	Fail	Pass	Total	% Fail
ST0003739	1983		1	1	0%
	1984	1	6	7	14%
	1985	1	7	8	13%
	1986	2	15	17	12%
	1987	1	15	16	6%
	1988	6	21	27	22%
	1989	4	24	28	14%
	1990	2	25	27	7%
	1991	3	20	23	13%
	1992	4	27	31	13%
	1993	4	30	34	12%
	1994	2	39	41	5%
	1995	2	65	67	3%
	1996	10	53	63	16%
	1997	5	77	82	6%
	1998	5	83	88	6%
	1999	10	114	124	8%
	2000	8	155	163	5%
2001	3	149	152	2%	
2002	2	42	44	5%	
2003	4	122	126	3%	
2004		31	31	0%	
ST0003739 Total		79	1,121	1,200	7%
ST0003746	1984	1	1	2	50%
	1985	2	4	6	33%
	1986	3	6	9	33%
	1987	3	5	8	38%
	1988	2	9	11	18%
	1989	4	12	16	25%
	1990	3	12	15	20%
	1991	1	15	16	6%
	1992	1	23	24	4%
	1993	4	24	28	14%
	1994	4	44	48	8%
	1995	5	33	38	13%
	1996	7	40	47	15%
	1997	4	69	73	5%
	1998	4	79	83	5%
	1999	6	78	84	7%
	2000	9	136	145	6%
	2001	6	144	150	4%
2002	4	40	44	9%	
2003	4	172	176	2%	
2004		7	7	0%	
ST0003746 Total		77	953	1,030	7%

Table (a) (3 & 4). # of Tests by Station, % Fail By Station					
Station ID	Model Year	Fail	Pass	Total	% Fail
ST0003767	1983	1	3	4	25%
	1984	5	12	17	29%
	1985	7	14	21	33%
	1986	15	33	48	31%
	1987	8	47	55	15%
	1988	6	65	71	8%
	1989	11	85	96	11%
	1990	9	81	90	10%
	1991	10	105	115	9%
	1992	17	139	156	11%
	1993	16	204	220	7%
	1994	12	241	253	5%
	1995	23	390	413	6%
	1996	44	289	333	13%
	1997	43	436	479	9%
	1998	43	452	495	9%
	1999	58	640	698	8%
	2000	78	952	1030	8%
	2001	66	961	1027	6%
	2002	15	262	277	5%
2003	28	1073	1101	3%	
2004	6	193	199	3%	
ST0003767 Total		521	6,677	7,198	7%
ST0003876	1983	1	2	3	33%
	1984	11	14	25	44%
	1985	8	24	32	25%
	1986	9	23	32	28%
	1987	14	38	52	27%
	1988	16	55	71	23%
	1989	16	89	105	15%
	1990	20	73	93	22%
	1991	6	96	102	6%
	1992	15	107	122	12%
	1993	12	169	181	7%
	1994	21	212	233	9%
	1995	21	305	326	6%
	1996	37	236	273	14%
	1997	25	312	337	7%
	1998	39	348	387	10%
	1999	47	466	513	9%
	2000	48	718	766	6%
	2001	45	672	717	6%
	2002	10	189	199	5%
2003	11	771	782	1%	
2004		70	70	0%	
ST0003876 Total		432	4,989	5,421	8%

Table (a) (3 & 4). # of Tests by Station, % Fail By Station					
Station ID	Model Year	Fail	Pass	Total	% Fail
ST0003932	1983		1	1	0%
	1984	6	12	18	33%
	1985	4	15	19	21%
	1986	10	19	29	34%
	1987	6	22	28	21%
	1988	7	36	43	16%
	1989	11	55	66	17%
	1990	12	62	74	16%
	1991	6	57	63	10%
	1992	12	98	110	11%
	1993	13	115	128	10%
	1994	17	179	196	9%
	1995	16	231	247	6%
	1996	23	188	211	11%
	1997	22	261	283	8%
	1998	24	313	337	7%
	1999	34	412	446	8%
	2000	24	617	641	4%
	2001	29	656	685	4%
	2002	8	138	146	5%
2003	15	698	713	2%	
2004	1	87	88	1%	
ST0003932 Total		300	4,272	4,572	7%
ST0003937	1983	2	1	3	67%
	1984	2	6	8	25%
	1985	5	7	12	42%
	1986	1	14	15	7%
	1987	3	20	23	13%
	1988	1	31	32	3%
	1989	2	29	31	6%
	1990	3	27	30	10%
	1991	3	25	28	11%
	1992	7	49	56	13%
	1993	3	80	83	4%
	1994	5	103	108	5%
	1995	8	114	122	7%
	1996	19	141	160	12%
	1997	18	183	201	9%
	1998	12	189	201	6%
	1999	20	305	325	6%
	2000	25	455	480	5%
	2001	18	469	487	4%
	2002	3	119	122	2%
2003	12	510	522	2%	
2004	2	79	81	2%	
ST0003937 Total		174	2,956	3,130	6%

Table (a) (3 & 4). # of Tests by Station, % Fail By Station					
Station ID	Model Year	Fail	Pass	Total	% Fail
ST0003943	1983	1		1	100%
	1984	6	28	34	18%
	1985	8	30	38	21%
	1986	20	41	61	33%
	1987	22	56	78	28%
	1988	16	84	100	16%
	1989	19	119	138	14%
	1990	13	103	116	11%
	1991	12	136	148	8%
	1992	19	166	185	10%
	1993	23	205	228	10%
	1994	20	273	293	7%
	1995	25	371	396	6%
	1996	42	285	327	13%
	1997	49	400	449	11%
	1998	48	394	442	11%
	1999	38	473	511	7%
	2000	42	685	727	6%
	2001	35	688	723	5%
	2002	10	158	168	6%
2003	15	612	627	2%	
2004	1	124	125	1%	
ST0003943 Total		484	5,431	5,915	8%
ST0003988	1984		3	3	0%
	1985	4	7	11	36%
	1986	2	16	18	11%
	1987	5	15	20	25%
	1988	4	22	26	15%
	1989	3	29	32	9%
	1990	8	29	37	22%
	1991	9	42	51	18%
	1992	4	53	57	7%
	1993	9	79	88	10%
	1994	7	111	118	6%
	1995	7	176	183	4%
	1996	17	173	190	9%
	1997	20	248	268	7%
	1998	19	262	281	7%
	1999	24	399	423	6%
	2000	30	614	644	5%
	2001	31	628	659	5%
	2002	5	149	154	3%
	2003	15	852	867	2%
2004	2	163	165	1%	
ST0003988 Total		225	4,070	4,295	5%

Table (a) (3 & 4). # of Tests by Station, % Fail By Station					
Station ID	Model Year	Fail	Pass	Total	% Fail
ST0003997	1984	4	23	27	15%
	1985	9	32	41	22%
	1986	11	32	43	26%
	1987	10	53	63	16%
	1988	6	71	77	8%
	1989	15	97	112	13%
	1990	11	94	105	10%
	1991	10	77	87	11%
	1992	12	126	138	9%
	1993	9	222	231	4%
	1994	12	265	277	4%
	1995	18	365	383	5%
	1996	40	318	358	11%
	1997	31	460	491	6%
	1998	23	456	479	5%
	1999	35	607	642	5%
	2000	63	939	1002	6%
	2001	61	894	955	6%
2002	8	232	240	3%	
2003	29	1166	1195	2%	
2004		126	126	0%	
ST0003997 Total		417	6,655	7,072	6%
ST0004004	1983	1	2	3	33%
	1984	2	15	17	12%
	1985	6	17	23	26%
	1986	6	28	34	18%
	1987	12	43	55	22%
	1988	13	61	74	18%
	1989	7	74	81	9%
	1990	10	75	85	12%
	1991	14	99	113	12%
	1992	14	148	162	9%
	1993	14	176	190	7%
	1994	21	235	256	8%
	1995	23	325	348	7%
	1996	44	324	368	12%
	1997	48	414	462	10%
	1998	43	480	523	8%
	1999	51	589	640	8%
	2000	59	916	975	6%
2001	61	888	949	6%	
2002	23	279	302	8%	
2003	34	1058	1092	3%	
2004	2	180	182	1%	
ST0004004 Total		508	6,426	6,934	7%

Table (a) (3 & 4). # of Tests by Station, % Fail By Station					
Station ID	Model Year	Fail	Pass	Total	% Fail
ST0004016	1983		1	1	0%
	1984	2	5	7	29%
	1985	3	5	8	38%
	1986	1	13	14	7%
	1987	4	12	16	25%
	1988		18	18	0%
	1989	2	26	28	7%
	1990	3	35	38	8%
	1991	4	37	41	10%
	1992	3	43	46	7%
	1993	4	79	83	5%
	1994	12	121	133	9%
	1995	4	179	183	2%
	1996	16	168	184	9%
	1997	24	249	273	9%
	1998	20	292	312	6%
	1999	31	428	459	7%
	2000	50	697	747	7%
	2001	47	669	716	7%
	2002	19	246	265	7%
2003	21	971	992	2%	
2004	2	131	133	2%	
ST0004016 Total		272	4,425	4,697	6%
ST0004034	1984	1	7	8	13%
	1985	8	13	21	38%
	1986	4	23	27	15%
	1987	9	38	47	19%
	1988	8	38	46	17%
	1989	8	38	46	17%
	1990	8	59	67	12%
	1991	17	74	91	19%
	1992	14	94	108	13%
	1993	16	145	161	10%
	1994	16	182	198	8%
	1995	17	229	246	7%
	1996	39	184	223	17%
	1997	34	251	285	12%
	1998	33	281	314	11%
	1999	27	305	332	8%
	2000	43	444	487	9%
	2001	37	415	452	8%
	2002	10	151	161	6%
	2003	17	488	505	3%
2004	2	69	71	3%	
ST0004034 Total		368	3,528	3,896	9%

Table (a) (3 & 4). # of Tests by Station, % Fail By Station					
Station ID	Model Year	Fail	Pass	Total	% Fail
ST0004040	1981		1	1	0%
	1984	4	5	9	44%
	1985	1	6	7	14%
	1986	4	9	13	31%
	1987	4	23	27	15%
	1988	5	22	27	19%
	1989	6	35	41	15%
	1990	6	53	59	10%
	1991	10	67	77	13%
	1992	13	74	87	15%
	1993	16	141	157	10%
	1994	13	171	184	7%
	1995	25	256	281	9%
	1996	48	183	231	21%
	1997	47	222	269	17%
	1998	31	255	286	11%
	1999	50	316	366	14%
	2000	45	420	465	10%
	2001	44	382	426	10%
	2002	15	189	204	7%
2003	13	454	467	3%	
2004	4	189	193	2%	
2005		1	1	0%	
ST0004040 Total		404	3,474	3,878	10%
ST0004080	1984		3	3	0%
	1985		4	4	0%
	1986		5	5	0%
	1987	3	7	10	30%
	1988		11	11	0%
	1989	2	6	8	25%
	1990		20	20	0%
	1991	1	25	26	4%
	1992	2	24	26	8%
	1993	4	27	31	13%
	1994	2	41	43	5%
	1995	4	58	62	6%
	1996	3	72	75	4%
	1997	2	90	92	2%
	1998	2	109	111	2%
	1999	9	168	177	5%
	2000	7	317	324	2%
2001	5	266	271	2%	
2002	4	106	110	4%	
2003	4	443	447	1%	
2004	1	174	175	1%	
ST0004080 Total		55	1,976	2,031	3%

Table (a) (3 & 4). # of Tests by Station, % Fail By Station					
Station ID	Model Year	Fail	Pass	Total	% Fail
ST0004105	1985	1	1	2	50%
	1986	2	1	3	67%
	1987	1	6	7	14%
	1988	1	11	12	8%
	1989	2	20	22	9%
	1990	3	29	32	9%
	1991	7	41	48	15%
	1992	9	63	72	13%
	1993	15	92	107	14%
	1994	13	101	114	11%
	1995	17	162	179	9%
	1996	35	118	153	23%
	1997	43	170	213	20%
	1998	33	182	215	15%
	1999	25	175	200	13%
	2000	32	223	255	13%
	2001	10	150	160	6%
2002	5	92	97	5%	
2003	10	129	139	7%	
2004	2	45	47	4%	
ST0004105 Total		266	1,811	2,077	13%
ST0004107	1983	1	3	4	25%
	1984	2	18	20	10%
	1985	6	33	39	15%
	1986	5	32	37	14%
	1987	12	42	54	22%
	1988	15	60	75	20%
	1989	3	56	59	5%
	1990	16	87	103	16%
	1991	6	96	102	6%
	1992	17	112	129	13%
	1993	17	168	185	9%
	1994	21	234	255	8%
	1995	30	357	387	8%
	1996	58	322	380	15%
	1997	54	341	395	14%
	1998	44	423	467	9%
	1999	51	517	568	9%
	2000	57	696	753	8%
2001	53	777	830	6%	
2002	15	319	334	4%	
2003	28	942	970	3%	
2004	6	273	279	2%	
2005		2	2	0%	
2006		1	1	0%	
ST0004107 Total		517	5,911	6,428	8%

Table (a) (3 & 4). # of Tests by Station, % Fail By Station					
Station ID	Model Year	Fail	Pass	Total	% Fail
ST0004111	1983	3	2	5	60%
	1984	4	12	16	25%
	1985	5	8	13	38%
	1986	1	18	19	5%
	1987	9	24	33	27%
	1988	4	31	35	11%
	1989	4	49	53	8%
	1990	13	57	70	19%
	1991	10	89	99	10%
	1992	21	86	107	20%
	1993	6	101	107	6%
	1994	6	169	175	3%
	1995	16	271	287	6%
	1996	41	241	282	15%
	1997	37	355	392	9%
	1998	40	407	447	9%
	1999	36	604	640	6%
	2000	61	843	904	7%
	2001	57	992	1049	5%
	2002	20	467	487	4%
2003	27	1268	1295	2%	
2004	4	374	378	1%	
ST0004111 Total		425	6,468	6,893	6%
ST0004144	1984		1	1	0%
	1985		1	1	0%
	1986		1	1	0%
	1988	1	1	2	50%
	1989	1	6	7	14%
	1990		4	4	0%
	1991		6	6	0%
	1992	1	10	11	9%
	1993	1	12	13	8%
	1994	2	15	17	12%
	1995	1	21	22	5%
	1996	6	26	32	19%
	1997	7	35	42	17%
	1998	8	47	55	15%
	1999	9	36	45	20%
	2000	4	67	71	6%
	2001	7	47	54	13%
	2002	2	26	28	7%
2003		50	50	0%	
2004		8	8	0%	
ST0004144 Total		50	420	470	11%

Table (a) (3 & 4). # of Tests by Station, % Fail By Station					
Station ID	Model Year	Fail	Pass	Total	% Fail
ST0004152	1983		1	1	0%
	1984		4	4	0%
	1985	2	6	8	25%
	1986	2	9	11	18%
	1987	3	15	18	17%
	1988	1	5	6	17%
	1989	4	15	19	21%
	1990	3	24	27	11%
	1991	3	25	28	11%
	1992	7	43	50	14%
	1993	4	48	52	8%
	1994	7	84	91	8%
	1995	6	105	111	5%
	1996	14	80	94	15%
	1997	8	123	131	6%
	1998	16	93	109	15%
	1999	10	162	172	6%
	2000	10	179	189	5%
	2001	5	120	125	4%
	2002	3	98	101	3%
2003	4	194	198	2%	
2004	2	122	124	2%	
ST0004152 Total		114	1,555	1,669	7%
ST0004161	1983	1		1	100%
	1984		1	1	0%
	1985	3	5	8	38%
	1986		6	6	0%
	1987	1	13	14	7%
	1988	2	10	12	17%
	1989	3	11	14	21%
	1990		20	20	0%
	1991		22	22	0%
	1992	3	30	33	9%
	1993	5	48	53	9%
	1994	3	69	72	4%
	1995	2	98	100	2%
	1996	12	80	92	13%
	1997	11	106	117	9%
	1998	13	108	121	11%
	1999	20	146	166	12%
	2000	10	257	267	4%
	2001	19	230	249	8%
	2002	2	94	96	2%
2003	10	294	304	3%	
2004		44	44	0%	
ST0004161 Total		120	1,692	1,812	7%

Table (a) (3 & 4). # of Tests by Station, % Fail By Station					
Station ID	Model Year	Fail	Pass	Total	% Fail
ST0004167	1983	1	1	2	50%
	1984	5	13	18	28%
	1985	3	9	12	25%
	1986	4	17	21	19%
	1987	6	29	35	17%
	1988	5	40	45	11%
	1989	11	34	45	24%
	1990	3	30	33	9%
	1991	7	48	55	13%
	1992	7	74	81	9%
	1993	7	108	115	6%
	1994	5	128	133	4%
	1995	9	187	196	5%
	1996	15	170	185	8%
	1997	21	221	242	9%
	1998	10	248	258	4%
	1999	16	340	356	4%
	2000	16	512	528	3%
	2001	17	461	478	4%
	2002	13	181	194	7%
2003	6	602	608	1%	
2004		117	117	0%	
ST0004167 Total		187	3,570	3,757	5%
ST0004170	1983		1	1	0%
	1984	2	7	9	22%
	1985	3	10	13	23%
	1986	3	20	23	13%
	1987	3	21	24	13%
	1988	4	24	28	14%
	1989	5	29	34	15%
	1990	5	38	43	12%
	1991	6	52	58	10%
	1992	7	52	59	12%
	1993	4	89	93	4%
	1994	9	114	123	7%
	1995	11	174	185	6%
	1996	20	148	168	12%
	1997	18	219	237	8%
	1998	19	248	267	7%
	1999	32	306	338	9%
	2000	41	501	542	8%
	2001	38	483	521	7%
	2002	16	154	170	9%
2003	24	587	611	4%	
2004	2	52	54	4%	
ST0004170 Total		272	3,329	3,601	8%

Table (a) (3 & 4). # of Tests by Station, % Fail By Station					
Station ID	Model Year	Fail	Pass	Total	% Fail
ST0004180	1983		1	1	0%
	1984	1	13	14	7%
	1985	4	13	17	24%
	1986	5	28	33	15%
	1987	10	25	35	29%
	1988	5	34	39	13%
	1989	5	45	50	10%
	1990	2	67	69	3%
	1991	10	80	90	11%
	1992	3	93	96	3%
	1993	14	112	126	11%
	1994	5	172	177	3%
	1995	10	202	212	5%
	1996	24	153	177	14%
	1997	24	256	280	9%
	1998	34	245	279	12%
	1999	30	362	392	8%
	2000	51	635	686	7%
	2001	40	733	773	5%
	2002	8	217	225	4%
2003	19	804	823	2%	
2004	3	133	136	2%	
ST0004180 Total		307	4,423	4,730	6%
ST0004191	1983	1		1	100%
	1984	5	2	7	71%
	1985	4	5	9	44%
	1986	4	8	12	33%
	1987	4	17	21	19%
	1988	5	13	18	28%
	1989	5	26	31	16%
	1990	4	31	35	11%
	1991	5	35	40	13%
	1992	4	52	56	7%
	1993	4	63	67	6%
	1994	1	92	93	1%
	1995	9	134	143	6%
	1996	9	83	92	10%
	1997	16	144	160	10%
	1998	9	143	152	6%
	1999	19	247	266	7%
	2000	26	363	389	7%
	2001	23	409	432	5%
	2002	6	129	135	4%
2003	14	563	577	2%	
2004	3	96	99	3%	
ST0004191 Total		180	2,655	2,835	6%

Table (a) (3 & 4). # of Tests by Station, % Fail By Station					
Station ID	Model Year	Fail	Pass	Total	% Fail
ST0004223	1995		2	2	0%
	1998		1	1	0%
	1999	1	2	3	33%
	2000		1	1	0%
	2001		1	1	0%
	2002		3	3	0%
ST0004223 Total		1	10	11	9%
ST0004230	1982	1	2	3	33%
	1983	3	4	7	43%
	1984	5	13	18	28%
	1985	5	22	27	19%
	1986	9	27	36	25%
	1987	8	42	50	16%
	1988	9	43	52	17%
	1989	10	73	83	12%
	1990	13	93	106	12%
	1991	16	94	110	15%
	1992	17	131	148	11%
	1993	21	162	183	11%
	1994	19	213	232	8%
	1995	24	326	350	7%
	1996	49	251	300	16%
	1997	30	360	390	8%
	1998	42	400	442	10%
	1999	47	598	645	7%
2000	73	951	1024	7%	
2001	58	1049	1107	5%	
2002	19	395	414	5%	
2003	38	1312	1350	3%	
2004	1	445	446	0%	
ST0004230 Total		517	7,006	7,523	7%

Table (a) (3 & 4). # of Tests by Station, % Fail By Station					
Station ID	Model Year	Fail	Pass	Total	% Fail
ST0004241	1984		1	1	0%
	1985		1	1	0%
	1986	1	1	2	50%
	1987	2	10	12	17%
	1988	1	6	7	14%
	1989		8	8	0%
	1990	3	11	14	21%
	1991		7	7	0%
	1992	1	16	17	6%
	1993	3	15	18	17%
	1994		26	26	0%
	1995	3	27	30	10%
	1996	4	36	40	10%
	1997	5	63	68	7%
	1998	3	61	64	5%
	1999	5	113	118	4%
	2000	9	94	103	9%
2001	2	31	33	6%	
2002	3	45	48	6%	
2003	3	227	230	1%	
2004		14	14	0%	
ST0004241 Total		48	813	861	6%
ST0004243	1983		1	1	0%
	1984		3	3	0%
	1985		4	4	0%
	1986	1	5	6	17%
	1987	1	9	10	10%
	1988		3	3	0%
	1989	1	3	4	25%
	1990	1	11	12	8%
	1991	1	7	8	13%
	1992		11	11	0%
	1993	1	13	14	7%
	1994	4	14	18	22%
	1995	1	22	23	4%
	1996		20	20	0%
	1997	3	35	38	8%
	1998	2	41	43	5%
	1999	3	67	70	4%
2000	4	103	107	4%	
2001	8	308	316	3%	
2002	2	56	58	3%	
2003	9	257	266	3%	
2004		68	68	0%	
ST0004243 Total		42	1,061	1,103	4%

Table (a) (3 & 4). # of Tests by Station, % Fail By Station					
Station ID	Model Year	Fail	Pass	Total	% Fail
ST0004257	1983	2	2	4	50%
	1984	4	19	23	17%
	1985	11	23	34	32%
	1986	6	41	47	13%
	1987	8	52	60	13%
	1988	16	74	90	18%
	1989	19	102	121	16%
	1990	18	88	106	17%
	1991	21	102	123	17%
	1992	20	158	178	11%
	1993	21	191	212	10%
	1994	32	276	308	10%
	1995	29	364	393	7%
	1996	43	307	350	12%
	1997	60	432	492	12%
	1998	44	425	469	9%
	1999	61	560	621	10%
	2000	71	879	950	7%
2001	63	860	923	7%	
2002	20	332	352	6%	
2003	26	1011	1037	3%	
2004	4	157	161	2%	
ST0004257 Total		599	6,455	7,054	8%
ST0004262	1982		1	1	0%
	1983		3	3	0%
	1984	4	14	18	22%
	1985	10	19	29	34%
	1986	9	43	52	17%
	1987	16	63	79	20%
	1988	6	78	84	7%
	1989	17	83	100	17%
	1990	18	119	137	13%
	1991	19	136	155	12%
	1992	16	165	181	9%
	1993	21	223	244	9%
	1994	37	304	341	11%
	1995	31	365	396	8%
	1996	56	311	367	15%
	1997	60	421	481	12%
	1998	66	436	502	13%
	1999	50	533	583	9%
2000	69	826	895	8%	
2001	73	774	847	9%	
2002	23	233	256	9%	
2003	29	832	861	3%	
2004	2	101	103	2%	
ST0004262 Total		632	6,083	6,715	9%

Table (a) (3 & 4). # of Tests by Station, % Fail By Station					
Station ID	Model Year	Fail	Pass	Total	% Fail
ST0004298	1983	1		1	100%
	1984	7	18	25	28%
	1985	3	22	25	12%
	1986	9	32	41	22%
	1987	12	68	80	15%
	1988	10	56	66	15%
	1989	13	79	92	14%
	1990	8	88	96	8%
	1991	9	131	140	6%
	1992	12	176	188	6%
	1993	15	212	227	7%
	1994	17	289	306	6%
	1995	26	375	401	6%
	1996	36	308	344	10%
	1997	41	430	471	9%
	1998	40	496	536	7%
	1999	36	672	708	5%
	2000	76	1003	1079	7%
	2001	65	974	1039	6%
	2002	10	313	323	3%
2003	51	1272	1323	4%	
2004	4	136	140	3%	
ST0004298 Total		501	7,150	7,651	7%
ST0004363	1984	1	5	6	17%
	1985	2	3	5	40%
	1986	3	6	9	33%
	1987	2	19	21	10%
	1988	4	26	30	13%
	1989	4	24	28	14%
	1990	2	30	32	6%
	1991	7	28	35	20%
	1992	2	52	54	4%
	1993	7	58	65	11%
	1994	8	68	76	11%
	1995	12	102	114	11%
	1996	4	77	81	5%
	1997	7	137	144	5%
	1998	5	136	141	4%
	1999	9	174	183	5%
	2000	12	324	336	4%
	2001	21	346	367	6%
	2002	3	87	90	3%
	2003	9	461	470	2%
2004	1	74	75	1%	
ST0004363 Total		125	2,237	2,362	5%

Table (a) (3 & 4). # of Tests by Station, % Fail By Station					
Station ID	Model Year	Fail	Pass	Total	% Fail
ST0004375	1983	1	1	2	50%
	1984	6	1	7	86%
	1985	4	4	8	50%
	1986	6	14	20	30%
	1987	5	23	28	18%
	1988	3	22	25	12%
	1989	6	28	34	18%
	1990	4	33	37	11%
	1991	5	30	35	14%
	1992	8	52	60	13%
	1993	3	81	84	4%
	1994	7	106	113	6%
	1995	9	182	191	5%
	1996	17	169	186	9%
	1997	21	230	251	8%
	1998	21	294	315	7%
	1999	24	456	480	5%
	2000	43	715	758	6%
	2001	37	767	804	5%
	2002	8	233	241	3%
2003	18	919	937	2%	
2004	4	125	129	3%	
ST0004375 Total		260	4,485	4,745	5%
ST0004377	1984	5	5	10	50%
	1985	2	16	18	11%
	1986		14	14	0%
	1987	3	18	21	14%
	1988	3	21	24	13%
	1989	3	22	25	12%
	1990	3	38	41	7%
	1991		26	26	0%
	1992	2	46	48	4%
	1993	2	61	63	3%
	1994	4	86	90	4%
	1995	5	157	162	3%
	1996	11	116	127	9%
	1997	29	198	227	13%
	1998	21	206	227	9%
	1999	12	311	323	4%
	2000	23	419	442	5%
	2001	22	480	502	4%
	2002	3	146	149	2%
	2003	16	541	557	3%
2004	2	133	135	1%	
ST0004377 Total		171	3,060	3,231	5%

Table (a) (3 & 4). # of Tests by Station, % Fail By Station					
Station ID	Model Year	Fail	Pass	Total	% Fail
ST0004397	1983	1	1	2	50%
	1984	2	16	18	11%
	1985	5	16	21	24%
	1986	6	22	28	21%
	1987	5	40	45	11%
	1988	5	51	56	9%
	1989	10	67	77	13%
	1990	10	88	98	10%
	1991	5	88	93	5%
	1992	7	93	100	7%
	1993	11	134	145	8%
	1994	3	194	197	2%
	1995	10	253	263	4%
	1996	8	196	204	4%
	1997	17	339	356	5%
	1998	9	365	374	2%
	1999	22	496	518	4%
	2000	14	840	854	2%
	2001	20	857	877	2%
	2002	5	264	269	2%
2003	20	1118	1138	2%	
2004	1	296	297	0%	
ST0004397 Total		196	5,834	6,030	3%
ST0004405	1983		1	1	0%
	1984	2	5	7	29%
	1985	1	7	8	13%
	1986	1	9	10	10%
	1987	2	12	14	14%
	1988	5	19	24	21%
	1989	4	22	26	15%
	1990	5	22	27	19%
	1991	4	36	40	10%
	1992		42	42	0%
	1993	5	58	63	8%
	1994	5	57	62	8%
	1995	6	99	105	6%
	1996	10	86	96	10%
	1997	6	146	152	4%
	1998	12	133	145	8%
	1999	10	208	218	5%
	2000	14	359	373	4%
	2001	14	413	427	3%
	2002	2	112	114	2%
2003	4	448	452	1%	
2004		119	119	0%	
ST0004405 Total		112	2,413	2,525	4%

Table (a) (3 & 4). # of Tests by Station, % Fail By Station					
Station ID	Model Year	Fail	Pass	Total	% Fail
ST0004480	1984	5	5	10	50%
	1985	4	6	10	40%
	1986	5	14	19	26%
	1987	9	26	35	26%
	1988	6	38	44	14%
	1989	19	53	72	26%
	1990	12	88	100	12%
	1991	16	100	116	14%
	1992	18	147	165	11%
	1993	21	203	224	9%
	1994	33	260	293	11%
	1995	32	344	376	9%
	1996	70	244	314	22%
	1997	73	362	435	17%
	1998	55	402	457	12%
	1999	50	430	480	10%
	2000	61	609	670	9%
2001	61	631	692	9%	
2002	13	331	344	4%	
2003	36	689	725	5%	
2004	3	217	220	1%	
ST0004480 Total		602	5,199	5,801	10%
ST0004525	1983	1	2	3	33%
	1984	4	25	29	14%
	1985	3	24	27	11%
	1986	4	28	32	13%
	1987	8	42	50	16%
	1988	7	49	56	13%
	1989	10	73	83	12%
	1990	15	71	86	17%
	1991	12	111	123	10%
	1992	17	130	147	12%
	1993	15	183	198	8%
	1994	20	212	232	9%
	1995	27	376	403	7%
	1996	55	296	351	16%
	1997	61	494	555	11%
	1998	64	507	571	11%
	1999	63	758	821	8%
2000	92	1137	1229	7%	
2001	66	1219	1285	5%	
2002	31	399	430	7%	
2003	45	1469	1514	3%	
2004	4	237	241	2%	
ST0004525 Total		624	7,842	8,466	7%

Table (a) (3 & 4). # of Tests by Station, % Fail By Station					
Station ID	Model Year	Fail	Pass	Total	% Fail
ST0004541	1983	1	1	2	50%
	1984	1	8	9	11%
	1985	4	12	16	25%
	1986	5	28	33	15%
	1987	4	26	30	13%
	1988	6	35	41	15%
	1989	4	41	45	9%
	1990	6	42	48	13%
	1991	7	51	58	12%
	1992	4	75	79	5%
	1993	5	94	99	5%
	1994	5	82	87	6%
	1995	13	152	165	8%
	1996	18	135	153	12%
	1997	18	199	217	8%
	1998	26	233	259	10%
	1999	21	298	319	7%
	2000	23	418	441	5%
	2001	25	404	429	6%
	2002	6	105	111	5%
2003	19	482	501	4%	
2004	1	57	58	2%	
ST0004541 Total		222	2,978	3,200	7%
ST0004582	1983		1	1	0%
	1984	2	6	8	25%
	1985	1	5	6	17%
	1986	1	7	8	13%
	1987	8	18	26	31%
	1988	6	19	25	24%
	1989	2	28	30	7%
	1990	9	27	36	25%
	1991	3	35	38	8%
	1992	9	62	71	13%
	1993	6	77	83	7%
	1994	10	93	103	10%
	1995	16	116	132	12%
	1996	25	103	128	20%
	1997	21	127	148	14%
	1998	16	134	150	11%
	1999	19	148	167	11%
	2000	19	169	188	10%
	2001	19	170	189	10%
	2002	1	72	73	1%
2003	6	169	175	3%	
2004		55	55	0%	
ST0004582 Total		199	1,641	1,840	11%

Table (a) (3 & 4). # of Tests by Station, % Fail By Station					
Station ID	Model Year	Fail	Pass	Total	% Fail
ST0004591	1983		1	1	0%
	1984	1	3	4	25%
	1985	3	10	13	23%
	1986	6	17	23	26%
	1987	5	16	21	24%
	1988	4	19	23	17%
	1989	4	28	32	13%
	1990	2	14	16	13%
	1991	4	26	30	13%
	1992	4	30	34	12%
	1993	2	46	48	4%
	1994	3	57	60	5%
	1995	9	68	77	12%
	1996	8	83	91	9%
	1997	9	114	123	7%
	1998	4	108	112	4%
	1999	8	150	158	5%
	2000	13	229	242	5%
	2001	11	162	173	6%
	2002	3	63	66	5%
2003	7	200	207	3%	
2004		38	38	0%	
ST0004591 Total		110	1,482	1,592	7%
ST0004592	1983	2	2	4	50%
	1984	3	17	20	15%
	1985	10	21	31	32%
	1986	6	43	49	12%
	1987	10	54	64	16%
	1988	12	57	69	17%
	1989	13	73	86	15%
	1990	7	67	74	9%
	1991	9	89	98	9%
	1992	8	95	103	8%
	1993	16	161	177	9%
	1994	13	178	191	7%
	1995	26	273	299	9%
	1996	31	260	291	11%
	1997	33	327	360	9%
	1998	14	296	310	5%
	1999	29	438	467	6%
	2000	24	629	653	4%
	2001	31	600	631	5%
	2002	11	255	266	4%
2003	15	822	837	2%	
2004	8	476	484	2%	
ST0004592 Total		331	5,233	5,564	6%

Table (a) (3 & 4). # of Tests by Station, % Fail By Station					
Station ID	Model Year	Fail	Pass	Total	% Fail
ST0004612	1983	1		1	100%
	1984		4	4	0%
	1985	5	4	9	56%
	1986	6	15	21	29%
	1987	4	13	17	24%
	1988	9	35	44	20%
	1989	6	24	30	20%
	1990	3	27	30	10%
	1991	5	24	29	17%
	1992	4	32	36	11%
	1993	3	40	43	7%
	1994	3	62	65	5%
	1995	8	81	89	9%
	1996	7	64	71	10%
	1997	10	96	106	9%
	1998	7	82	89	8%
	1999	9	110	119	8%
	2000	15	167	182	8%
	2001	4	87	91	4%
	2002	4	34	38	11%
2003	3	117	120	3%	
2004	1	5	6	17%	
ST0004612 Total		117	1,123	1,240	9%
ST0004615	1983		1	1	0%
	1984	1	2	3	33%
	1985		1	1	0%
	1986	1	5	6	17%
	1987	1	8	9	11%
	1988	3	12	15	20%
	1989	1	22	23	4%
	1990	3	24	27	11%
	1991	2	28	30	7%
	1992	4	35	39	10%
	1993	11	50	61	18%
	1994	4	61	65	6%
	1995	3	88	91	3%
	1996	10	84	94	11%
	1997	12	127	139	9%
	1998	8	134	142	6%
	1999	15	196	211	7%
	2000	22	295	317	7%
	2001	29	335	364	8%
	2002	2	70	72	3%
2003	5	383	388	1%	
2004		25	25	0%	
ST0004615 Total		137	1,986	2,123	6%

Table (a) (3 & 4). # of Tests by Station, % Fail By Station					
Station ID	Model Year	Fail	Pass	Total	% Fail
ST0004619	1985	1		1	100%
	1986		1	1	0%
	1987		1	1	0%
	1988	1	2	3	33%
	1989	1	3	4	25%
	1990	1	9	10	10%
	1991		1	1	0%
	1992	1	7	8	13%
	1993		6	6	0%
	1994		7	7	0%
	1995		15	15	0%
	1996	2	14	16	13%
	1997		30	30	0%
	1998	3	25	28	11%
	1999	2	30	32	6%
	2000		15	15	0%
	2001		5	5	0%
2002		10	10	0%	
2003	4	22	26	15%	
2004		7	7	0%	
ST0004619 Total		16	210	226	7%
ST0004628	1984		2	2	0%
	1985	1	4	5	20%
	1986	2	10	12	17%
	1987		15	15	0%
	1988	2	18	20	10%
	1989	1	31	32	3%
	1990	4	30	34	12%
	1991	5	33	38	13%
	1992	9	63	72	13%
	1993	7	84	91	8%
	1994	5	109	114	4%
	1995	8	139	147	5%
	1996	31	139	170	18%
	1997	26	236	262	10%
	1998	23	276	299	8%
	1999	27	364	391	7%
	2000	39	559	598	7%
2001	48	571	619	8%	
2002	15	151	166	9%	
2003	17	646	663	3%	
2004		54	54	0%	
ST0004628 Total		270	3,534	3,804	7%

Table (a) (3 & 4). # of Tests by Station, % Fail By Station					
Station ID	Model Year	Fail	Pass	Total	% Fail
ST0004632	1984	5	10	15	33%
	1985	3	12	15	20%
	1986	5	29	34	15%
	1987	4	33	37	11%
	1988	10	34	44	23%
	1989	8	46	54	15%
	1990	12	49	61	20%
	1991	10	57	67	15%
	1992	7	107	114	6%
	1993	9	144	153	6%
	1994	19	179	198	10%
	1995	19	259	278	7%
	1996	41	214	255	16%
	1997	31	289	320	10%
	1998	46	287	333	14%
	1999	40	420	460	9%
	2000	39	567	606	6%
2001	38	522	560	7%	
2002	12	216	228	5%	
2003	17	623	640	3%	
2004	1	165	166	1%	
ST0004632 Total		376	4,262	4,638	8%
ST0004657	1982		1	1	0%
	1983	1	3	4	25%
	1984	5	18	23	22%
	1985	5	21	26	19%
	1986	4	40	44	9%
	1987	13	59	72	18%
	1988	11	72	83	13%
	1989	20	94	114	18%
	1990	11	86	97	11%
	1991	14	103	117	12%
	1992	14	124	138	10%
	1993	16	188	204	8%
	1994	12	224	236	5%
	1995	23	314	337	7%
	1996	34	283	317	11%
	1997	34	415	449	8%
	1998	35	423	458	8%
1999	35	550	585	6%	
2000	43	862	905	5%	
2001	45	884	929	5%	
2002	8	243	251	3%	
2003	17	972	989	2%	
2004	2	194	196	1%	
ST0004657 Total		402	6,173	6,575	6%

Table (a) (3 & 4). # of Tests by Station, % Fail By Station					
Station ID	Model Year	Fail	Pass	Total	% Fail
ST0004658	1983		3	3	0%
	1984	3	9	12	25%
	1985	6	10	16	38%
	1986	6	20	26	23%
	1987	11	36	47	23%
	1988	9	35	44	20%
	1989	5	48	53	9%
	1990	1	48	49	2%
	1991	6	65	71	8%
	1992	6	84	90	7%
	1993	8	109	117	7%
	1994	8	146	154	5%
	1995	7	178	185	4%
	1996	18	158	176	10%
	1997	13	224	237	5%
	1998	14	258	272	5%
	1999	17	341	358	5%
	2000	20	560	580	3%
	2001	21	503	524	4%
	2002	13	212	225	6%
2003	13	663	676	2%	
2004	1	216	217	0%	
ST0004658 Total		206	3,926	4,132	5%
ST0004696	1984	1	9	10	10%
	1985	4	7	11	36%
	1986	2	13	15	13%
	1987	3	24	27	11%
	1988	4	30	34	12%
	1989	5	44	49	10%
	1990	4	39	43	9%
	1991	13	55	68	19%
	1992	10	65	75	13%
	1993	6	89	95	6%
	1994	7	99	106	7%
	1995	15	157	172	9%
	1996	16	124	140	11%
	1997	20	217	237	8%
	1998	21	200	221	10%
	1999	27	283	310	9%
	2000	36	431	467	8%
	2001	17	398	415	4%
	2002	9	129	138	7%
	2003	12	461	473	3%
2004	1	60	61	2%	
ST0004696 Total		233	2,934	3,167	7%

Table (a) (3 & 4). # of Tests by Station, % Fail By Station					
Station ID	Model Year	Fail	Pass	Total	% Fail
ST0004701	1983	2	1	3	67%
	1984	6	8	14	43%
	1985	5	25	30	17%
	1986	14	38	52	27%
	1987	10	45	55	18%
	1988	11	67	78	14%
	1989	7	78	85	8%
	1990	11	92	103	11%
	1991	7	81	88	8%
	1992	11	104	115	10%
	1993	10	159	169	6%
	1994	14	179	193	7%
	1995	19	314	333	6%
	1996	24	275	299	8%
	1997	22	316	338	7%
	1998	29	392	421	7%
	1999	37	486	523	7%
	2000	48	799	847	6%
	2001	47	794	841	6%
	2002	11	212	223	5%
2003	20	810	830	2%	
2004	3	81	84	4%	
ST0004701 Total		368	5,356	5,724	6%
ST0004710	1983	1	3	4	25%
	1984	7	12	19	37%
	1985	5	19	24	21%
	1986	7	28	35	20%
	1987	13	32	45	29%
	1988	11	55	66	17%
	1989	5	42	47	11%
	1990	4	50	54	7%
	1991	8	50	58	14%
	1992	4	62	66	6%
	1993	14	92	106	13%
	1994	10	101	111	9%
	1995	7	146	153	5%
	1996	5	142	147	3%
	1997	5	170	175	3%
	1998	3	193	196	2%
	1999	6	202	208	3%
	2000	4	264	268	1%
	2001	6	189	195	3%
	2002	2	50	52	4%
2003	1	220	221	0%	
2004		17	17	0%	
ST0004710 Total		128	2,139	2,267	6%

Table (a) (3 & 4). # of Tests by Station, % Fail By Station					
Station ID	Model Year	Fail	Pass	Total	% Fail
ST0004713	1984	3	10	13	23%
	1985	12	18	30	40%
	1986	11	33	44	25%
	1987	5	32	37	14%
	1988	7	38	45	16%
	1989	11	59	70	16%
	1990	12	47	59	20%
	1991	7	52	59	12%
	1992	8	75	83	10%
	1993	22	104	126	17%
	1994	11	129	140	8%
	1995	14	180	194	7%
	1996	22	145	167	13%
	1997	23	187	210	11%
	1998	15	194	209	7%
	1999	24	221	245	10%
	2000	26	324	350	7%
	2001	24	293	317	8%
2002	10	92	102	10%	
2003	7	304	311	2%	
2004	2	21	23	9%	
ST0004713 Total		276	2,558	2,834	10%
ST0004722	1981	1		1	100%
	1983		2	2	0%
	1984	4	16	20	20%
	1985	9	26	35	26%
	1986	14	47	61	23%
	1987	18	73	91	20%
	1988	21	98	119	18%
	1989	20	106	126	16%
	1990	26	133	159	16%
	1991	15	146	161	9%
	1992	29	214	243	12%
	1993	33	270	303	11%
	1994	26	345	371	7%
	1995	29	503	532	5%
	1996	51	457	508	10%
	1997	79	648	727	11%
	1998	62	681	743	8%
	1999	67	941	1008	7%
2000	92	1372	1464	6%	
2001	86	1381	1467	6%	
2002	32	464	496	6%	
2003	53	1782	1835	3%	
2004	5	452	457	1%	
ST0004722 Total		772	10,157	10,929	7%

Table (a) (3 & 4). # of Tests by Station, % Fail By Station					
Station ID	Model Year	Fail	Pass	Total	% Fail
ST0004739	1983		2	2	0%
	1984	5	10	15	33%
	1985	5	21	26	19%
	1986	9	24	33	27%
	1987	10	40	50	20%
	1988	5	44	49	10%
	1989	10	53	63	16%
	1990	6	41	47	13%
	1991	14	74	88	16%
	1992	6	96	102	6%
	1993	10	109	119	8%
	1994	12	205	217	6%
	1995	14	245	259	5%
	1996	19	256	275	7%
	1997	32	382	414	8%
	1998	29	425	454	6%
	1999	44	604	648	7%
	2000	29	836	865	3%
2001	60	829	889	7%	
2002	16	383	399	4%	
2003	34	1128	1162	3%	
2004	9	784	793	1%	
ST0004739 Total		378	6,591	6,969	5%
ST0004745	1984		8	8	0%
	1985	7	11	18	39%
	1986	3	16	19	16%
	1987	8	27	35	23%
	1988	4	26	30	13%
	1989	7	34	41	17%
	1990	3	30	33	9%
	1991	4	34	38	11%
	1992	5	45	50	10%
	1993	7	64	71	10%
	1994	5	78	83	6%
	1995	3	104	107	3%
	1996	15	103	118	13%
	1997	19	113	132	14%
	1998	18	128	146	12%
	1999	8	180	188	4%
	2000	18	248	266	7%
	2001	19	218	237	8%
2002	2	72	74	3%	
2003	7	216	223	3%	
2004	1	51	52	2%	
ST0004745 Total		163	1,806	1,969	8%

Table (a) (3 & 4). # of Tests by Station, % Fail By Station					
Station ID	Model Year	Fail	Pass	Total	% Fail
ST0004750	1983	2	1	3	67%
	1984	1	11	12	8%
	1985	4	23	27	15%
	1986	12	29	41	29%
	1987	8	34	42	19%
	1988	7	39	46	15%
	1989	12	62	74	16%
	1990	8	58	66	12%
	1991	11	71	82	13%
	1992	21	111	132	16%
	1993	17	134	151	11%
	1994	12	217	229	5%
	1995	23	275	298	8%
	1996	44	269	313	14%
	1997	58	313	371	16%
	1998	43	298	341	13%
	1999	55	465	520	11%
	2000	53	691	744	7%
	2001	64	621	685	9%
2002	22	252	274	8%	
2003	27	707	734	4%	
2004	4	82	86	5%	
ST0004750 Total		508	4,763	5,271	10%
ST0004761	1996	4		4	100%
	1998	1		1	100%
	1999	1		1	100%
	2000	3		3	100%
		1		1	100%
ST0004761 Total		10		10	100%
ST0004762	1984	3	10	13	23%
	1985	1	8	9	11%
	1986	6	23	29	21%
	1987	10	31	41	24%
	1988	7	25	32	22%
	1989	5	28	33	15%
	1990	5	31	36	14%
	1991	4	37	41	10%
	1992	10	45	55	18%
	1993	9	80	89	10%
	1994	6	109	115	5%
	1995	13	158	171	8%
	1996	13	143	156	8%
	1997	8	214	222	4%
	1998	6	199	205	3%
	1999	17	228	245	7%
	2000	10	312	322	3%
	2001	24	352	376	6%
2002	7	88	95	7%	
2003	8	340	348	2%	
2004	2	53	55	4%	
2005		1	1	0%	
2006		1	1	0%	
ST0004762 Total		174	2,516	2,690	6%

Table (a) (3 & 4). # of Tests by Station, % Fail By Station					
Station ID	Model Year	Fail	Pass	Total	% Fail
ST0004764	1984	1	3	4	25%
	1985	2	7	9	22%
	1986	1	1	2	50%
	1987		9	9	0%
	1988	1	13	14	7%
	1989		11	11	0%
	1990	2	17	19	11%
	1991	2	24	26	8%
	1992	3	44	47	6%
	1993	1	35	36	3%
	1994	1	47	48	2%
	1995	3	85	88	3%
	1996	11	56	67	16%
	1997	8	87	95	8%
	1998	9	113	122	7%
	1999	8	183	191	4%
	2000	11	294	305	4%
	2001	12	339	351	3%
2002		111	111	0%	
2003	2	443	445	0%	
2004		84	84	0%	
ST0004764 Total		78	2,006	2,084	4%
ST0004765	1983		1	1	0%
	1984	2	5	7	29%
	1985	4	13	17	24%
	1986	6	17	23	26%
	1987	6	19	25	24%
	1988	6	31	37	16%
	1989	7	31	38	18%
	1990	9	46	55	16%
	1991	5	57	62	8%
	1992	17	71	88	19%
	1993	4	97	101	4%
	1994	24	143	167	14%
	1995	12	170	182	7%
	1996	36	206	242	15%
	1997	45	264	309	15%
	1998	34	282	316	11%
	1999	27	383	410	7%
	2000	41	513	554	7%
2001	36	463	499	7%	
2002	14	171	185	8%	
2003	29	548	577	5%	
2004	2	77	79	3%	
ST0004765 Total		366	3,608	3,974	9%

Table (a) (3 & 4). # of Tests by Station, % Fail By Station					
Station ID	Model Year	Fail	Pass	Total	% Fail
ST0004769	1983		1	1	0%
	1984	4	16	20	20%
	1985	7	13	20	35%
	1986	4	12	16	25%
	1987	6	18	24	25%
	1988	2	26	28	7%
	1989	5	43	48	10%
	1990	5	41	46	11%
	1991	9	43	52	17%
	1992	6	47	53	11%
	1993	9	63	72	13%
	1994	8	95	103	8%
	1995	12	141	153	8%
	1996	4	113	117	3%
	1997	17	159	176	10%
	1998	10	157	167	6%
	1999	24	240	264	9%
	2000	35	347	382	9%
	2001	36	337	373	10%
	2002	9	100	109	8%
2003	13	415	428	3%	
2004		67	67	0%	
ST0004769 Total		225	2,494	2,719	8%
ST0004772	1983		1	1	0%
	1984	1	3	4	25%
	1985	4	15	19	21%
	1986	6	20	26	23%
	1987	5	29	34	15%
	1988	5	38	43	12%
	1989	6	48	54	11%
	1990	5	26	31	16%
	1991	8	63	71	11%
	1992	6	71	77	8%
	1993	5	98	103	5%
	1994	9	123	132	7%
	1995	12	166	178	7%
	1996	9	127	136	7%
	1997	18	225	243	7%
	1998	19	200	219	9%
	1999	13	282	295	4%
	2000	22	382	404	5%
	2001	12	388	400	3%
	2002	2	88	90	2%
2003	6	375	381	2%	
2004		11	11	0%	
ST0004772 Total		173	2,780	2,953	6%

Table (a) (3 & 4). # of Tests by Station, % Fail By Station					
Station ID	Model Year	Fail	Pass	Total	% Fail
ST0004777	1984	3	13	16	19%
	1985	6	12	18	33%
	1986	4	29	33	12%
	1987	10	25	35	29%
	1988	5	46	51	10%
	1989	13	59	72	18%
	1990	7	53	60	12%
	1991	9	68	77	12%
	1992	15	92	107	14%
	1993	11	126	137	8%
	1994	24	185	209	11%
	1995	29	222	251	12%
	1996	36	186	222	16%
	1997	32	292	324	10%
	1998	36	273	309	12%
	1999	46	363	409	11%
	2000	38	574	612	6%
2001	36	477	513	7%	
2002	16	205	221	7%	
2003	13	563	576	2%	
2004	1	112	113	1%	
ST0004777 Total		390	3,975	4,365	9%
ST0004788	1983		2	2	0%
	1984	3	7	10	30%
	1985	4	6	10	40%
	1986	4	22	26	15%
	1987	3	18	21	14%
	1988	10	35	45	22%
	1989	12	61	73	16%
	1990	10	62	72	14%
	1991	18	82	100	18%
	1992	18	112	130	14%
	1993	23	131	154	15%
	1994	23	190	213	11%
	1995	23	208	231	10%
	1996	56	185	241	23%
	1997	61	206	267	23%
	1998	44	223	267	16%
	1999	38	300	338	11%
2000	48	360	408	12%	
2001	43	344	387	11%	
2002	16	174	190	8%	
2003	20	435	455	4%	
2004	1	110	111	1%	
ST0004788 Total		478	3,273	3,751	13%

Table (a) (3 & 4). # of Tests by Station, % Fail By Station					
Station ID	Model Year	Fail	Pass	Total	% Fail
ST0004810	1983		1	1	0%
	1984		1	1	0%
	1985	1	3	4	25%
	1986	6	7	13	46%
	1987	2	12	14	14%
	1988	3	6	9	33%
	1989	1	18	19	5%
	1990	2	17	19	11%
	1991		18	18	0%
	1992		21	21	0%
	1993	5	30	35	14%
	1994	4	47	51	8%
	1995	10	77	87	11%
	1996	3	65	68	4%
	1997	9	95	104	9%
	1998	9	94	103	9%
	1999	9	152	161	6%
	2000	10	176	186	5%
	2001	2	47	49	4%
	2002	2	45	47	4%
2003	5	167	172	3%	
2004		7	7	0%	
ST0004810 Total		83	1,106	1,189	7%
ST0004816	1984	2	6	8	25%
	1985	4	9	13	31%
	1986	5	15	20	25%
	1987	3	14	17	18%
	1988	5	29	34	15%
	1989	7	37	44	16%
	1990	3	32	35	9%
	1991	4	45	49	8%
	1992	4	54	58	7%
	1993	6	86	92	7%
	1994	11	118	129	9%
	1995	6	138	144	4%
	1996	16	117	133	12%
	1997	16	174	190	8%
	1998	12	186	198	6%
	1999	16	259	275	6%
	2000	11	381	392	3%
	2001	17	328	345	5%
	2002	5	103	108	5%
	2003	13	430	443	3%
2004	2	78	80	3%	
ST0004816 Total		168	2,639	2,807	6%

Table (a) (3 & 4). # of Tests by Station, % Fail By Station					
Station ID	Model Year	Fail	Pass	Total	% Fail
ST0004817	1984	2	3	5	40%
	1985	2	1	3	67%
	1986	2	7	9	22%
	1987	3	16	19	16%
	1988	3	14	17	18%
	1989	4	19	23	17%
	1990	2	37	39	5%
	1991	5	38	43	12%
	1992	11	50	61	18%
	1993	1	76	77	1%
	1994	8	90	98	8%
	1995	2	128	130	2%
	1996	13	151	164	8%
	1997	8	128	136	6%
	1998	12	154	166	7%
	1999	9	196	205	4%
	2000	10	295	305	3%
	2001	21	221	242	9%
2002	6	57	63	10%	
2003	3	235	238	1%	
2004		19	19	0%	
ST0004817 Total		127	1,935	2,062	6%
ST0004820	1981		1	1	0%
	1983	2	1	3	67%
	1984	6	7	13	46%
	1985	5	11	16	31%
	1986	9	19	28	32%
	1987	11	36	47	23%
	1988	10	32	42	24%
	1989	7	61	68	10%
	1990	14	91	105	13%
	1991	20	77	97	21%
	1992	13	123	136	10%
	1993	28	165	193	15%
	1994	25	212	237	11%
	1995	19	305	324	6%
	1996	69	208	277	25%
	1997	69	255	324	21%
	1998	44	243	287	15%
	1999	38	315	353	11%
	2000	42	352	394	11%
2001	21	294	315	7%	
2002	12	113	125	10%	
2003	22	201	223	10%	
2004	1	20	21	5%	
2005		1	1	0%	
ST0004820 Total		487	3,143	3,630	13%

Table (a) (3 & 4). # of Tests by Station, % Fail By Station					
Station ID	Model Year	Fail	Pass	Total	% Fail
ST0004826	1985		1	1	0%
	1989		1	1	0%
	1990	1	2	3	33%
	1991	1	2	3	33%
	1992		2	2	0%
	1993		8	8	0%
	1994		2	2	0%
	1995		5	5	0%
	1996	1	10	11	9%
	1997		16	16	0%
	1998		12	12	0%
	1999	2	13	15	13%
	2000		20	20	0%
	2001	1	10	11	9%
	2002	1	15	16	6%
2003		44	44	0%	
2004		4	4	0%	
ST0004826 Total		7	167	174	4%
ST0004827	1984		1	1	0%
	1985	2	2	4	50%
	1986	2	2	4	50%
	1987		1	1	0%
	1988		1	1	0%
	1989		5	5	0%
	1990	1	3	4	25%
	1991		5	5	0%
	1992		1	1	0%
	1993	1	6	7	14%
	1994		7	7	0%
	1995		10	10	0%
	1996		9	9	0%
	1997		10	10	0%
	1998		13	13	0%
1999		11	11	0%	
2000	1	6	7	14%	
2001		2	2	0%	
2002		3	3	0%	
2003		9	9	0%	
ST0004827 Total		7	107	114	6%

Table (a) (3 & 4). # of Tests by Station, % Fail By Station					
Station ID	Model Year	Fail	Pass	Total	% Fail
ST0004828	1983	3	1	4	75%
	1984	2	12	14	14%
	1985	3	16	19	16%
	1986	6	27	33	18%
	1987	10	36	46	22%
	1988	21	64	85	25%
	1989	16	86	102	16%
	1990	18	100	118	15%
	1991	25	138	163	15%
	1992	36	167	203	18%
	1993	29	275	304	10%
	1994	27	377	404	7%
	1995	40	439	479	8%
	1996	81	306	387	21%
	1997	108	427	535	20%
	1998	83	419	502	17%
	1999	78	532	610	13%
	2000	84	766	850	10%
	2001	79	669	748	11%
	2002	25	226	251	10%
2003	24	707	731	3%	
2004	3	63	66	5%	
ST0004828 Total		801	5,853	6,654	12%
ST0004837	1984	2	5	7	29%
	1985		14	14	0%
	1986	3	15	18	17%
	1987	6	33	39	15%
	1988	9	46	55	16%
	1989	5	45	50	10%
	1990	9	57	66	14%
	1991	4	60	64	6%
	1992	18	79	97	19%
	1993	10	141	151	7%
	1994	21	158	179	12%
	1995	14	218	232	6%
	1996	33	180	213	15%
	1997	33	243	276	12%
	1998	21	257	278	8%
	1999	29	323	352	8%
	2000	40	416	456	9%
	2001	35	424	459	8%
	2002	6	122	128	5%
	2003	12	377	389	3%
2004		33	33	0%	
ST0004837 Total		310	3,246	3,556	9%

Table (a) (3 & 4). # of Tests by Station, % Fail By Station					
Station ID	Model Year	Fail	Pass	Total	% Fail
ST0004839	1983	2	3	5	40%
	1984	1	18	19	5%
	1985	4	16	20	20%
	1986	7	24	31	23%
	1987	7	38	45	16%
	1988	12	46	58	21%
	1989	14	51	65	22%
	1990	7	71	78	9%
	1991	6	81	87	7%
	1992	10	104	114	9%
	1993	12	127	139	9%
	1994	13	197	210	6%
	1995	16	258	274	6%
	1996	20	195	215	9%
	1997	26	293	319	8%
	1998	32	293	325	10%
	1999	39	463	502	8%
	2000	43	635	678	6%
	2001	40	667	707	6%
	2002	11	236	247	4%
2003	25	787	812	3%	
2004	6	286	292	2%	
ST0004839 Total		353	4,889	5,242	7%
ST0004843	1983	1	4	5	20%
	1984	4	10	14	29%
	1985	6	17	23	26%
	1986	8	25	33	24%
	1987	7	42	49	14%
	1988	10	41	51	20%
	1989	6	59	65	9%
	1990	9	46	55	16%
	1991	13	64	77	17%
	1992	15	104	119	13%
	1993	13	133	146	9%
	1994	22	228	250	9%
	1995	20	252	272	7%
	1996	32	237	269	12%
	1997	29	329	358	8%
	1998	28	351	379	7%
	1999	40	500	540	7%
	2000	63	789	852	7%
	2001	66	806	872	8%
	2002	12	190	202	6%
2003	36	1046	1082	3%	
2004	6	164	170	4%	
ST0004843 Total		446	5,437	5,883	8%

Table (a) (3 & 4). # of Tests by Station, % Fail By Station					
Station ID	Model Year	Fail	Pass	Total	% Fail
ST0004847	1983	1	1	2	50%
	1984	3	14	17	18%
	1985	4	11	15	27%
	1986	8	20	28	29%
	1987	12	35	47	26%
	1988	5	48	53	9%
	1989	6	51	57	11%
	1990	4	61	65	6%
	1991	10	58	68	15%
	1992	7	74	81	9%
	1993	11	126	137	8%
	1994	17	139	156	11%
	1995	6	216	222	3%
	1996	23	171	194	12%
	1997	25	261	286	9%
	1998	27	244	271	10%
	1999	25	351	376	7%
	2000	36	550	586	6%
	2001	45	513	558	8%
	2002	6	116	122	5%
2003	15	598	613	2%	
2004	1	42	43	2%	
ST0004847 Total		297	3,700	3,997	7%
ST0004854	1983		4	4	0%
	1984	6	10	16	38%
	1985	7	21	28	25%
	1986	12	29	41	29%
	1987	7	52	59	12%
	1988	13	65	78	17%
	1989	13	78	91	14%
	1990	18	101	119	15%
	1991	15	108	123	12%
	1992	20	185	205	10%
	1993	23	242	265	9%
	1994	35	288	323	11%
	1995	33	428	461	7%
	1996	58	358	416	14%
	1997	65	477	542	12%
	1998	67	528	595	11%
	1999	61	649	710	9%
	2000	64	959	1023	6%
	2001	87	798	885	10%
	2002	30	296	326	9%
2003	37	1020	1057	4%	
2004	1	133	134	1%	
ST0004854 Total		672	6,829	7,501	9%

Table (a) (3 & 4). # of Tests by Station, % Fail By Station					
Station ID	Model Year	Fail	Pass	Total	% Fail
ST0004855	1982		1	1	0%
	1983		1	1	0%
	1984	3	13	16	19%
	1985	9	10	19	47%
	1986	8	19	27	30%
	1987	11	37	48	23%
	1988	11	40	51	22%
	1989	15	50	65	23%
	1990	17	66	83	20%
	1991	13	85	98	13%
	1992	26	111	137	19%
	1993	31	133	164	19%
	1994	18	153	171	11%
	1995	26	247	273	10%
	1996	47	160	207	23%
	1997	41	213	254	16%
	1998	38	206	244	16%
	1999	30	231	261	11%
	2000	31	302	333	9%
	2001	28	236	264	11%
2002	16	74	90	18%	
2003	5	211	216	2%	
2004	1	28	29	3%	
ST0004855 Total		425	2,627	3,052	14%
ST0004866	1983	1		1	100%
	1984	7	6	13	54%
	1985	8	7	15	53%
	1986	10	15	25	40%
	1987	8	23	31	26%
	1988	10	36	46	22%
	1989	9	36	45	20%
	1990	14	59	73	19%
	1991	13	64	77	17%
	1992	17	116	133	13%
	1993	17	161	178	10%
	1994	18	180	198	9%
	1995	17	226	243	7%
	1996	42	163	205	20%
	1997	69	262	331	21%
	1998	51	218	269	19%
	1999	50	318	368	14%
	2000	60	390	450	13%
	2001	37	359	396	9%
	2002	13	128	141	9%
2003	16	338	354	5%	
2004	3	41	44	7%	
ST0004866 Total		490	3,146	3,636	13%

Table (a) (3 & 4). # of Tests by Station, % Fail By Station					
Station ID	Model Year	Fail	Pass	Total	% Fail
ST0004867	1983	1	2	3	33%
	1984	12	15	27	44%
	1985	8	27	35	23%
	1986	13	42	55	24%
	1987	14	65	79	18%
	1988	24	105	129	19%
	1989	19	121	140	14%
	1990	21	135	156	13%
	1991	23	154	177	13%
	1992	34	205	239	14%
	1993	36	266	302	12%
	1994	37	392	429	9%
	1995	36	500	536	7%
	1996	71	388	459	15%
	1997	98	568	666	15%
	1998	76	561	637	12%
	1999	86	676	762	11%
	2000	89	936	1025	9%
	2001	104	1000	1104	9%
	2002	39	330	369	11%
2003	43	1173	1216	4%	
2004	8	137	145	6%	
ST0004867 Total		892	7,798	8,690	10%
ST0004868	1983		3	3	0%
	1984	3	4	7	43%
	1985	4	7	11	36%
	1986	5	15	20	25%
	1987	6	21	27	22%
	1988	2	28	30	7%
	1989	5	28	33	15%
	1990	3	39	42	7%
	1991	4	33	37	11%
	1992	4	53	57	7%
	1993	6	77	83	7%
	1994	9	87	96	9%
	1995	13	131	144	9%
	1996	14	100	114	12%
	1997	13	156	169	8%
	1998	19	133	152	13%
	1999	14	201	215	7%
	2000	8	203	211	4%
	2001	8	58	66	12%
	2002	1	58	59	2%
2003	8	213	221	4%	
2004		24	24	0%	
ST0004868 Total		149	1,672	1,821	8%

Table (a) (3 & 4). # of Tests by Station, % Fail By Station					
Station ID	Model Year	Fail	Pass	Total	% Fail
ST0004870	1986		1	1	0%
	1987		1	1	0%
	1988		2	2	0%
	1990		5	5	0%
	1991	1	3	4	25%
	1992		5	5	0%
	1993	1	2	3	33%
	1994		3	3	0%
	1995	1	1	2	50%
	1996		8	8	0%
	1997	1	11	12	8%
	1998	4	5	9	44%
	1999	3	19	22	14%
	2000	2	20	22	9%
	2001	4	58	62	6%
	2002		8	8	0%
2003	1	46	47	2%	
2004		14	14	0%	
ST0004870 Total		18	212	230	8%
ST0004871	1984		3	3	0%
	1985		8	8	0%
	1986	3	3	6	50%
	1987	2	7	9	22%
	1988	2	4	6	33%
	1989	2	6	8	25%
	1990	2	13	15	13%
	1991	1	16	17	6%
	1992	2	17	19	11%
	1993	4	32	36	11%
	1994	6	38	44	14%
	1995	9	43	52	17%
	1996	5	48	53	9%
	1997	8	63	71	11%
	1998	7	77	84	8%
	1999	9	97	106	8%
	2000	20	241	261	8%
	2001	26	307	333	8%
2002	5	42	47	11%	
2003	8	221	229	3%	
2004		39	39	0%	
ST0004871 Total		121	1,325	1,446	8%
Grand Total		79,983	970,110	1,050,093	8%

Table (b) (1 & 2(i, ii & v)). Quality Assurance			
Parameter	Beginning Year	of Left Program	Added to Program
No. of Inspection stations/lanes operating throughout 2007	294	17	9
Receiving overt performance audits in 2007	262		
Not receiving overt performance audits in 2007	0		
That have been shut down as a result of overt performance audits	0		

Table (b) (2)(iii, iv) & (3, 8 & 9). Quality Assurance			
No. of Inspection stations/lanes operating throughout 2007	All Test Types	OBD Tests	ASM Tests
Receiving Covert Audit	262		
Not Receiving Covert Audit	0		
Number of Covert Audits	1203	1136	67
Conducted with vehicle set to fail	1012	1012	
Conducted with vehicle set to fail any combination of two or more types	N/A	N/A	N/A
Resulting in a false Pass	300	300	0
Resulting in a false Pass for any combination of two or more test types	N/A	N/A	N/A
Total number of Covert vehicles available for undercover audits over the year	8	5	3
Total number of Covert auditors available for undercover audits over the year	17	17	17

Table (b) (4)(i & ii). Quality Assurance		
Parameter	Stations	Inspectors
Suspended as a result of covert audits	0	4
Suspended for other causes	2	36

Table (b) (5). Quality Assurance	
Certified Testing Inspectors as of 12/31/07	974

Table (d) (1)(v). Enforcement Report	
Time Extension and Other exemptions	8,492

Table (d) (3)(i). Enforcement Report		
Number and % of subject vehicles that were tested by the initial deadline		
	#	%
On Due date	32,384	3.47%
1-30 days early	389,326	41.77%
31-60 days early	175,712	18.85%
61-90 days early	7,162	0.76%
91-120 days early	4,349	0.46%
> 120 days early	24,273	2.60%
1-30 days late	108,399	11.63%
31-60 days late	30,199	3.24%
61-90 days late	16,170	1.73%
91-120 days late	11,437	1.22%
> 120 days late	132,635	14.23%

Figures based on 'Noticed' vehicles/tested volume of 932,046

Report (d), (5) Enforcement Report	
Number of Inspectors licensed or certified to conduct testing as of 12/31/07	974

Table (c) (1,2,3 & 4). Quality Control				
Station #	Station Name	Lane number	Initial Gas Audits	Initial Gas Audit Fail
0001	Valley Dodge	1	2	1
0015	Artioli Kia	1	1	0
0017	Morande Linc-Merc	1	2	0
0019	Artioli Dodge	1	2	0
0020	Cargill Chevrolet Co	1	2	0
0023	Robert's Chrysler-Dodge	1	2	1
0034	Bob Valenti Chevrolet-Olds	1	3	3
0036	Hoffman Auto Group	1	3	1
0060	Dan Perkins Chevrolet	1	3	0
0065	Stevens Ford Linc-Merc	1	3	0
0107	King Olds-Cadillac	1	3	1
0112	Brustolon	1	2	0
0116	Simon Ford	1	0	0
0120	Girard Ford	1	3	2
0128	Southworths Dodge	1	2	2
0129	Southworth's Chrysler	1	3	1
0132	Middletown Toyota	1	2	2
0136	Parson's Buick	1	0	0
0168	Merriam Motors	1	1	1
0169	Key Lincoln Mercury	1	0	0
0171	O'Neills	1	3	1
0193	M J Sullivan Auto	1	3	2
0229	Hartford Toyota Superstore	1	2	0
0315	Schaller Tire Distributer	1	2	2
0326	Midas	1	2	2
0328	Automotive Plus	1	2	0
0359	Laurel Automotive	1	2	2
0386	Hamelin & Sons	1	2	0
0412	Arnold's Garage	1	3	3
0434	Midas	1	2	2
0469	Lees Auto Center	1	2	2
0493	Midas	1	2	0
0516	Hallmark Tire Co	1	3	2
0520	Farmington Motor Sports	1	2	2
0525	Firestone	1	2	0
0549	Morande Ford	1	2	0
0557	Kensington Auto	1	4	1
0581	J & M Corvettes	1	3	0
0616	Firestone	1	2	0
0618	Computer Tune & Lube	1	3	0
0621	Ex-Per Tech	1	3	1

Table (c) (1,2,3 & 4). Quality Control				
Station #	Station Name	Lane number	Initial Gas Audits	Initial Gas Audit Fail
0648	Bolton Motors	1	3	1
0697	Firestone	1	2	1
0718	Ceglarz	1	2	0
0725	Story Bros, Inc.	1	5	1
0730	Midas	1	3	2
0776	Anthony's Service	1	3	1
0779	Central Conn Tire	1	2	1
0790	Farm Car Care	1	2	1
0809	Moore's Auto	1	2	0
0825	Meineke	1	3	0
0915	Bolles Chrysler-Didge	1	1	0
0951	Ready Credit	1	5	2
0963	Firestone	1	2	1
0969	Meineke	1	3	1
0971	Computer Tune & Lube	1	3	2
0972	Mad Hatter	1	2	1
0976	Midas	1	4	0
0986	Suburban Tire	1	4	0
0994	Tolland Citgo	1	2	1
1051	L and J Service	1	4	1
1056	Scata's Auto	1	2	0
1066	Bobby G's	1	2	1
1095	Prospect Foreign Car	1	2	0
1131	Main Street Automotive	1	2	
1193	Herb's Auto Electric	1	3	1
1214	Rick's Auto	1	1	0
1216	Wethersfield Auto	1	3	2
1220	Midas - Rocky Hill	1	1	0
1235	Valvoline	1	2	0
1253	Midas	1	3	1
1264	Mike's Auto	1	2	1
1267	Mirabelli Auto	1	3	1
1270	R & M Auto	1	2	2
1274	West Hill Auto	1	3	1
1284	Modern Tire	1	3	0
1294	Modern Tire	1	2	2
1297	Aquas Buenas	1	3	1
1299	B & S Auto	1	2	0

Table (c) (1,2,3 & 4). Quality Control				
Station #	Station Name	Lane number	Initial Gas Audits	Initial Gas Audit Fail
1303	South Green Auto	1	3	1
1363	Midas	1	2	0
1368	Lyons Service	1	2	0
1371	Cox's Service	1	2	0
1377	A & P Auto	1	3	0
1401	Nutmeg Auto	1	2	2
1423	Midas	1	3	0
1470	Columbia Car Care	1	3	0
1511	T and B Motor Sales	1	3	0
1519	Raymond's Auto	1	3	1
1594	Town Hill Auto	1	2	0
1613	Midas	1	2	0
1615	Firestone	1	3	1
1646	Bob's Auto	1	4	2
1660	Midas	1	2	1
1662	Meineke	1	2	0
1679	Montville Auto	1	2	0
1704	Precision Motors, Inc.	1	3	1
1725	Nick's Service Center	1	3	1
1767	Firestone	1	3	0
1797	Shoreline Service	1	2	2
1799	All Pro Automotive	1	3	1
1805	Plainfield Shell	1	3	0
1835	Montville Auto	1	4	1
1852	Marvin's Midway	1	3	1
1876	General Muffler	1	2	2
1889	Gabe's Service Station	1	2	1
1896	A & M Service Station	1	2	1
1944	Branford Auto Center	1	2	0
1969	Cheshire Shell Service	1	1	1
1970	Cheshire Tire & Auto	1	2	1
2018	D and R Automotive	1	3	1
2020	Hammonasset Ford	1	2	2
2026	Desmonds Auto Sales	1	3	0
2060	Cromwell Automotive	1	2	0
2080	Derby Auto	1	1	0
2120	Greenfield Hill Service	1	3	0
2133	Firestone	1	3	1

Table (c) (1,2,3 & 4). Quality Control

Station #	Station Name	Lane number	Initial Gas Audits	Initial Gas Audit Fail
2134	Brooklawn Service Center	1	2	1
2141	Fairfield Tire & Auto	1	3	1
2149	Meineke	1	4	3
2153	Sport Hill Service Station.	1	2	1
2175	Audi of Fairfield	1	3	1
2178	Nick's Precision Auto	1	3	0
2181	Auto Associates	1	2	0
2233	Cos' Central Auto	1	4	0
2267	Harte Chevrolet	1	4	1
2304	Alarcon Tire Co	1	2	0
2318	Fine Tunes	1	2	2
2330	BellTown Motors	1	2	0
2340	European Motorcars	1	2	1
2351	Towne & Country	1	0	0
2358	Computer Tune & Lube	1	2	1
2365	Midas	1	3	1
2373	Personal Auto Care	1	3	2
2380	New Image Auto	1	3	3
2419	Robert's Service Center	1	3	0
2427	Westshore Motors	1	2	2
2493	Amaral Motors, Inc.	1	3	2
2526	Horseless Carriage	1	0	0
2554	Bouchard Automotive.	1	2	1
2560	Tech One Automotive	1	2	1
2573	Oceanside Auto	1	2	1
2593	Bens Service Center	1	2	1
2603	Meineke	1	4	1
2631	Portland Automotive	1	3	2
2651	East Coast Four-Wheel	1	2	1
2652	Falbos Tire and Auto	1	2	1
2672	AJ'S Center Service	1	2	1
2722	Computer Tune and Lube	1	3	1
2740	Mad Hatter Muffler	1	3	1
2744	Tire Depot Plus	1	2	1
2770	South Colony Mobil	1	2	0
2822	Frenchys Auto .	1	4	0
2830	Nelson's Automotive	1	3	0
2880	Broadbridge Auto Service	1	2	2
2884	Don Schiffer's Auto	1	3	0
2903	Cars, Inc.	1	4	1

Table (c) (1,2,3 & 4). Quality Control

Station #	Station Name	Lane number	Initial Gas Audits	Initial Gas Audit Fail
2915	Midas	1	3	1
2919	Meineke Discount Mufflers	1	2	1
2955	Nova Automotive	1	3	2
2964	Canzanella Brothers	1	3	2
3004	Annex Auto Repair	1	2	1
3086	Barco Motors, Inc.	1	3	2
3102	Auto Specialist	1	2	1
3106	Campbell Motor Sales.	1	2	0
3107	Chuck's Garage	1	4	1
3176	Circle A Auto	1	2	2
3190	Partyka Chevrolet	1	3	1
3192	Dougan Automotive	1	12	2
3225	Tire Doctor	1	2	1
3253	Crest Lincoln Mercury	1	2	2
3263	Firestone	1	2	1
3292	Joey's Capitol-Wood	1	2	1
3406	Genesis Motorworks	1	3	2
3432	E & S Auto	1	3	0
3437	Monroe Muffler	1	2	2
3449	Boston Ave Auto (Getty)	1	2	1
3458	Knecht's Garage	1	3	2
3483	Breezy Point Auto	1	3	1
3498	Model Garage.	1	3	1
3548	Montambault's	1	9	4
3592	Superior Transmissions	1	4	1
3662	United Auto	1	2	1
3724	Superior Transmissions	1	3	0
3732	Litchfield Hills Motorsports	1	3	1
3739	Bennett Motor Works	1	3	1
3746	Sunshine Car Repair	1	2	1
3767	Mezzio Auto Body	1	3	2
3876	The Quiet Zone	1	2	1
3932	Wilson Dodge Nissan	1	2	1
3937	Northwest Hills Chrysler	1	2	2
3943	Bahr Auto Repair	1	2	0
3988	Valenti Motors	1	2	3
3997	Murray Bros Garage	1	3	2
4004	Belardinelli Tire Comp	1	3	2

Table (c) (1,2,3 & 4). Quality Control

Station #	Station Name	Lane number	Initial Gas Audits	Initial Gas Audit Fail
4016	Firestone	1	4	4
4034	A 1 Service Center	1	2	1
4040	Cardinale Auto Repair.	1	2	1
4080	Danbury Chevy Olds	1	2	0
4105	E.M. Auto Repair	1	3	3
4107	Federal Towing	1	3	1
4111	Wilton Service	1	3	2
4144	Advanced Auto Repair	1	2	1
4152	Motor Works	1	3	2
4161	Danbury Autowerks	1	2	0
4167	Superior Service (Getty)	1	2	0
4170	New Fairfield Automotive	1	2	0
4180	Noroton Getty	1	3	2
4191	Darien Auto Center	1	2	0
4230	Greenwich Shell	1	6	3
4241	New Canaan Exxon	1	0	0
4243	AC Autobody	1	2	0
4257	New Canaan Ave. Service	1	3	0
4262	The Brigg's Tire Co.	1	2	2
4298	Hank Mays Goodyear	1	2	1
4363	Soundview North Service	1	3	1
4375	Copps Hill Shell	1	2	2
4377	Limestone Service	1	2	1
4397	Green's Farms Shell	1	2	1
4405	Weston Service Center	1	3	0
4480	Stamford Firestone	1	2	1
4525	High Ridge Shell	1	3	1
4541	Sotires Auto Diagnostic	1	5	2
4582	A-OK Auto Center	1	2	1
4591	AutoWorks of Devon	1	5	4
4592	Avery Brothers	1	2	1
4612	Platt Automotive	1	2	1
4615	Firestone	1	4	0
4619	Bill Selig Ford	1	0	0
4628	Firestone	1	2	1
4632	Burt Humphrey & Sons	1	3	4
4657	Essex Service Center	1	4	4
4658	Fairfield Auto & Truck	1	2	2
4696	Long Ridge Service	1	2	1
4701	Martin & Parson's Auto	1	2	1

Table (c) (1,2,3 & 4). Quality Control

Station #	Station Name	Lane number	Initial Gas Audits	Initial Gas Audit Fail
4710	Middlesex Auto Center	1	2	1
4713	Milex Auto Repair	1	2	1
4722	Mobile Lube Express	1	3	2
4739	Precision Motor Coach	1	3	0
4745	R.K. Rogers	1	3	3
4750	Sam Wibberley	1	2	0
4762	Auto Tek	1	4	3
4764	Suburban Subaru	1	2	0
4765	Meineke	1	3	3
4769	The Quiet Zone	1	3	3
4772	Tim's Auto Center	1	2	1
4777	Townline Auto Sales	1	3	0
4788	West High Service	1	3	0
4810	Valvoline	1	1	0
4816	Valenti Pontiac	1	2	0
4817	High Tech Auto	1	2	1
4820	John & Son's Auto	1	3	0
4826	Suburban Mitsubishi	1	0	0
4827	Balkos Service	1	1	0
4828	Waterbury Tire & Auto	1	2	0
4837	Car Tune	1	3	1
4839	Hank Mays Goodyear	1	3	1
4843	Toyota of Colchester	1	3	2
4847	Tarcas Hebron Quick Lube	1	2	12
4854	Valvoline	1	4	1
4855	Auto Parts Mart	1	3	0
4866	Lee Myles Transmissions	1	2	2
4867	Foxy Fast Lube	1	2	1
4868	Artioli Chevrolet	1	1	0
4870	Middlebury Garage	1	3	2
4871	Midas Milford	1	3	2
FL 1001	City of Bristol	1	2	0
FL 1002	Aquarion Water	1	2	0
FL 1003	Regional Water	1	2	0
FL 1004	ATT- Middletown	1	1	0
FL 1005	Stamford PD	1	2	0
FL 1006	Hunter Ambulance	1	2	0
FL 1007	New Haven PD	1	2	0
FL 1008	Cablevison - Bridgeport	1	2	0

Table (c) (1,2,3 & 4). Quality Control				
Station #	Station Name	Lane number	Initial Gas Audits	Initial Gas Audit Fail
FL 1009	Cablevision - Norwalk	1	2	0
FL1010	Town of Trumbull	1	2	0
FL 1011	University of Hartford	1	1	0
FL 1012	Town of Guilford	1	2	0
FL 1013	Southern CT Gas	1	2	0
FL 1014	CT DAS - New Haven	1	2	0
FL 1015	CT DAS - Norwich	1	2	0
FL 1016	CT - DAS Wethersfield	1	2	0
FL 1017	City of Waterbury	1	2	0
FL 1018	CNG	1	2	0
FL 1019	ATT - Meriden	1	2	0
FL 1020	ATT - Winsted	1	1	1
FL 1021	ATT - Waterbury	1	2	1
FL 1022	ATT - Danbury	1	1	1
FL 1023	ATT - Stamford	1	2	0
FL 1024	ATT - Shelton	1	1	1
FL 1025	ATT - Stratford	1	1	1
FL 1026	ATT - Norwalk	1	2	1
FL 1027	ATT - New Haven	1	2	0
FL 1028	ATT - No. Branford	1	2	0
FL 1029	ATT - Waterford	1	2	0
FL 1030	ATT - No. Windham	1	2	0
FL 1031	ATT - Enfield	1	2	0
FL 1032	ATT- Hartford	1	2	0

NOTE: Stations 116, 136, 169, 2351, 2526, 4241, 4619 and 4826 exited the program early in 2007 and therefore did not undergo any audits that year.

Total Stations in Program	298
Total Equipment Audits	732
Total Equipment Audit Fails	282
Number of Stations failing an equipment (gas) audit¹	181
Percentage of stations faing an equipment (gas) audit¹	60.7%
Number of Stations shut down as a result of a failed equipment (gas) audit²	0
Percentage of stations shut down as a result of a failed equipment (gas) audit²	0%

¹ Failures are limited to gas calibration audits. By contract, Testing contractor must resolve equipment failures within 24 hours.

² Stations are prohibited from performing tailpipe emission testing only until the equipment problem is resolved. Stations continue to perform OBD testing (In 2007 - 71.6% of all tests).

Enforcement Report: (d) (1)(i & ii), (2), & (3)(ii & iii).

(d) Enforcement Report –

(1) All varieties of enforcement programs shall, at a minimum

(i) An estimate of the number of vehicles subject to the inspection program, including the results of an analysis of the registration data base:

Connecticut's estimated emission eligible population is two million vehicles per testing cycle. During 2007, 71.58% of initial inspections were OBD tests.

(ii) The percentage of motorist compliance based upon a comparison of the number of valid final tests with the number of subject vehicles.

Connecticut's compliance rate was approximately 96.7 % for 2007.

(2) Registration Denial bases enforcement programs shall provide the following additional information.

(i) A report of the program's efforts and actions to prevent motorists from falsely registering vehicles out of the program area or falsely changing fuel type or weight class on the vehicle registration, and the results of special studies to investigate the frequency of such activity:

Connecticut does not perform an analysis of its emission eligible database to detect vehicles that are falsely registered out of state to avoid being emission testing in the state. The majority of vehicles registered with an incorrect GVWR are those where the vehicle owner registers the vehicle at a lower weight to avoid the added expense and would not be emission eligible (>10,000 lbs.) with their corrected weight. Connecticut tests all fuel types, including hybrids.

(ii) The number of registration file audits, number of registrations reviewed and compliance rates found in such audits.

In 2007, 889,965 vehicle registrations were audited, which detected a compliance rate of 96%. Of the 4% that were found to be out of compliance, 92.4% were later brought into compliance.

(3) Computer matching based enforcement programs shall provide the following additional information:

(ii) A report on the program's efforts to detect and enforce against motorists falsely changing vehicle classifications to circumvent program requirements, and the frequency of this type of activity:

Enforcement Report: (d) (1)(i & ii), (2), & (3)(ii & iii). ...continued

97.7% of emission eligible vehicles in Connecticut are in the Passenger, Commercial or Combination classifications. Because of the added expense, documentation and inspection requirements needed to change a vehicle's registration classification to a non-emission eligible class, incidents of such modifications are rare.

(iii) The number of enforcement system audits and the error rate found during those audits:

Connecticut's program uses both registration denial and late fee assessment to enforce emission testing compliance. In 2007, 889,965 registration renewals were audited, resulting in 37,078 denials of which 34,278 later complied. And, in 2007, 84,217 late fees were assessed.