

Appendix G: EMF Report



**Electric and Magnetic
Field Assessment:
The Pequonnock
Substation Rebuild
Project**



Electric and Magnetic Field Assessment: The Pequonnock Substation Rebuild Project

Prepared for

The United Illuminating Company
180 Marsh Hill Rd.
Orange, CT 06477

Prepared by

Exponent
420 Lexington Ave.
Suite 1740
New York, NY 10170

February 15, 2018

© Exponent, Inc.

Contents

	<u>Page</u>
List of Figures	2
List of Tables	4
Notice	5
Executive Summary	6
Introduction	9
Technical Background	15
Measurement and Modeling Profiles	17
Assessment Criteria	20
Methods	22
Measurements	22
Magnetic-Field Modeling	22
Results and Discussion	27
Perimeter Profiles	28
Profiles 1-6	29
Structures and Buildings	32
Electric Fields	33
Conclusions	34
Consistency with CSC Best Management Practices	35

List of Figures

	<u>Page</u>
Figure 1. Plan view of the existing Pequonnock Substation and surrounding area, showing the location of existing overhead 115-kV circuits on the adjacent ROW. The Bridgeport Energy Interconnection is not in service and therefore not shown.	11
Figure 2. Plan view of the proposed Pequonnock Substation and surrounding area, showing the repositioned spans of the overhead 115-kV circuits on the adjacent ROW.	12
Figure 3. One-line diagram of the existing 115-kV transmission system showing overhead and underground circuits terminating at the existing Pequonnock Substation.	13
Figure 4. One-line diagram of the proposed 115-kV transmission system showing overhead and underground circuits terminating at the proposed Pequonnock Substation.	14
Figure 5. Electric- and magnetic-field levels in the environment.	16
Figure 6. Plan view of the Project vicinity, showing existing and proposed substation yards and the location of calculated profiles.	18
Figure 7. Overview of the three-dimensional SUBCALC model used to calculate magnetic fields for the existing Pequonnock Substation.	24
Figure 8. Overview of the three-dimensional SUBCALC model used to calculate magnetic fields for the proposed Pequonnock Substation, including repositioned 115-kV transmission lines on the adjoining ROW.	25
Figure 9. Measured and calculated magnetic-field profiles around the perimeter of the existing Pequonnock Substation sites for average-load conditions in the year 2027. Measured magnetic fields reflect existing substation and loading on November 15, 2017.	39
Figure 10. Measured and calculated magnetic-field profiles around the property line of the proposed Pequonnock Substation for average-load conditions in the year 2027. Measured magnetic fields reflect existing substation and loading on November 15, 2017.	40
Figure 11. Calculated magnetic-field profiles around the property line of the proposed Pequonnock Substation for peak-load conditions in the year 2018.	41
Figure 12. Calculated and measured magnetic-field levels along Profile 1.	42
Figure 13. Calculated and measured magnetic-field levels along Profile 2.	43

Figure 14. Calculated and measured magnetic-field levels along Profile 3.	44
Figure 15. Calculated and measured magnetic-field levels along Profile 4.	46
Figure 16. Calculated and measured magnetic-field levels along Profile 5.	47
Figure 17. Calculated and measured magnetic-field levels along Profile 6.	48
Figure 18. Locations of electric field-measurements.	49

List of Tables

	<u>Page</u>
Table 1. ICNIRP and ICES guidelines for EMF exposure at 60-Hz	21
Table 2. Summary of calculated magnetic fields (mG) for Profiles 2 – 6 for average-load conditions in 2027	37
Table 3. Summary of calculated magnetic fields (mG) for Profiles 2 – 6 for peak-load conditions in 2018	37
Table 4. Summary of calculated magnetic fields (mG) at designated structures	38
Table 5. Summary of measured electric fields	50

Notice

At the request of The United Illuminating Company (UI), Exponent modeled the electric and magnetic fields associated with the rebuild of the existing Pequonnock Substation in the City of Bridgeport, Connecticut. This report summarizes work performed to date and presents the findings resulting from that work. In the analysis, we have relied on geometry, material data, usage conditions, specifications, and various other types of information provided by UI. We cannot verify the correctness of this input data, and rely on the client for the data's accuracy. UI has confirmed to Exponent that the summary of data provided to Exponent contained herein is not subject to Critical Energy Infrastructure Information restrictions. Although Exponent has exercised usual and customary care in the conduct of this analysis, the responsibility for the design and operation of the project remains fully with the client.

The findings presented herein are made to a reasonable degree of engineering and scientific certainty. Exponent reserves the right to supplement this report and to expand or modify opinions based on review of additional material as it becomes available, through any additional work, or review of additional work performed by others.

The scope of services performed during this investigation may not adequately address the needs of other users of this report, and any re-use of this report or its findings, conclusions, or recommendations presented herein other than for permitting of this project are at the sole risk of the user. The opinions and comments formulated during this assessment are based on observations and information available at the time of the investigation. No guarantee or warranty as to future life or performance of any reviewed condition is expressed or implied.

Executive Summary

The United Illuminating Company (UI) proposes to rebuild the existing Pequonnock Substation (the Project) located at 1 Atlantic Street in the City of Bridgeport, Connecticut. The proposed site of the new Pequonnock Substation is on the western side of the Public Service Electric and Gas Company (PSEG) Power Connecticut, LLC parcel at 1 Kiefer Street, west of Bridgeport Harbor Station 3 (BHS3) and north of the Bridgeport Energy generation facility. The proposed site is part of a 3.7-acre parcel that UI plans to acquire from PSEG; this parcel includes approximately 2 acres within the existing PSEG fence line (where the new substation will be built), as well as lands to the north, including Ferry Access Road. Both the existing and proposed sites are in industrial areas, south of the existing railroad/transmission line right-of-way (ROW), which includes Metro-North Railroad (MNR) tracks and catenary structures of the New Haven Rail Line. The closest residential neighborhood is located on the west side of Main Street. The nearest proposed equipment is approximately 480 feet from the closest single-family dwelling to the southwest.

As part of the Project, UI proposes to relocate sections of four overhead transmission lines on the adjoining railroad ROW, which terminate at the existing Pequonnock Substation. UI will relocate sections of these circuits to new steel monopole structures north of the proposed site, and terminate the repositioned circuits at the proposed Pequonnock Substation. In addition, UI will extend and re-terminate additional circuits as follows: (1) existing overhead interconnection to BHS3; and (2) three underground circuits to the Singer Substation and substations in the Naugatuck Valley corridor (the Trumbull, Old Town, and Devon Substations).

The effect of the Pequonnock Substation rebuild on existing magnetic-field levels was evaluated by modeling magnetic fields for pre- and post-Project configurations. The pre-Project configuration includes the overhead and underground transmission lines in their existing alignments. Modeling of the post-Project conditions uses the same loadings as in the pre-Project configuration, but with (1) the rebuilt substation in operation, (2) the existing Pequonnock Substation de-energized, and (3) the existing eight transmission lines re-terminated at the proposed substation. Two load cases were studied for both pre- and post-Project

configurations, corresponding to 2027 average load and 2018 peak load. Pre-project electric and magnetic fields were also measured around the existing substation on November 15, 2017.

Comparing pre- and post-Project conditions, the modeling shows that the calculated magnetic fields are approximately the same *magnitude* but have a different *position*. This similarity arises because the equipment in the new Pequonnock Substation will be similar in topology and dimensions to the equipment in the existing Pequonnock Substation and the loads at the Pequonnock Substation do not change significantly as a result of the rebuild. As a result, calculated magnetic fields are nearly the same before and after operation of the Project, but are shifted westward with the proposed equipment.

The largest calculated magnetic field in the Project vicinity is 150 mG, above the existing 115 kV underground circuit near Ferry Access Road, and offset by approximately 20 feet from the existing 345 kV underground cables of Middletown-Norwalk Line. In the post-Project configuration, the 115-kV underground source is repositioned to exit north of the proposed site of the Pequonnock substation, approximately 700 feet southwest of its existing location. Likewise, calculated magnetic fields beneath the overhead circuits range from 55 to 100 mG, and are also shifted west with operation of the Project. There are no occupied facilities in the vicinity of the repositioned underground and overhead circuits, which are located in vacant land or areas with transportation uses. In addition, since an existing portion of the 115 kV underground circuit is removed along Ferry Access Road between the existing and proposed sites of the Pequonnock Substation, the calculated magnetic field decreases above this portion of the road.

For the peak-load case, the loading on some overhead lines decreases and the loading on other lines increases. The magnitude of these changes is small, however, and as a result the calculated magnetic field beneath the new overhead terminations ranges between 45 mG and 115 mG.

While operation of the Project affects the location of calculated magnetic fields between the substation and the existing transmission corridor, it has little effect at structures and dwellings in the surrounding community. At structures and dwellings along Main Street (located west of the

proposed substation), for instance, calculated magnetic fields before and after operation of the project differ by approximately 0.2 mG or less.

The highest measured electric field (0.12 kV/m) was recorded beneath the conductors of the existing overhead terminations on the north side of the existing substation. Only small electric-field values (below 0.03 kV/m) were measured on around the sites of the existing and proposed Pequonnock Substation. Electric-field levels will not differ appreciably around the proposed Pequonnock Substation since the configuration of equipment and overhead interconnections is similar to pre-Project conditions.

Introduction

The existing Pequonnock Substation is located on a 1.5-acre parcel at 1 Atlantic Street in the City of Bridgeport, Connecticut. The northeastern portion of the site directly abuts Bridgeport Harbor. Based on a March 2016 Asset Condition study, the United Illuminating Company (UI) determined that the existing Pequonnock Substation is “at-risk” of being destroyed by a FEMA 100-year flood event. The study also identified significant equipment and structural deficiencies at the existing substation.

The UI Coastal Substation Flood Mitigation Solution Report, which was completed January 23, 2017,¹ provided the mitigating strategy for each of the various “at-risk” UI substations. Due to the combination of asset condition deficiencies and flooding risk at the existing substation site, UI proposes that the Pequonnock Substation be rebuilt at an elevation at least three feet above the FEMA 100-year base flood elevation, on a new site located approximately 700 feet southwest of the existing substation location.

The proposed site of the new Pequonnock Substation is on the western side of the PSEG Power Connecticut, LLC parcel at 1 Keifer Street, north of the Bridgeport Energy generation facility. *See* Figure 1 and Figure 2. North of the proposed site is the existing railroad/transmission line right-of-way (ROW), which includes Metro North Railroad (MNR) tracks and catenary structures of the New Haven Rail Line (Figure 1). As shown in Figure 1, five overhead 115-kV circuits² terminate at the existing Pequonnock Substation:

- two overhead 115-kV circuits that proceed north on the west and east sides of the MNR tracks, designated Line “A” and Line “B”;
- two overhead 115-kV that proceed west on both sides of the MNR corridor, designated Line “C” east and Line “D;” and
- one 115 kV interconnection to Bridgeport Harbor Station 3 (BHS3).

¹ UI Coastal Substation Flood Mitigation Solution Report – Final, 1/23/2017, available at the following link: <https://www.iso-ne.com/committees/planning/planning-advisory>

² 115-kV circuits identified as: “A” (8809A), “B” (8909B), “C” (1130), “D” (91001), and BHS3

Underground transmission circuits terminating at the Pequonnock Substation, which are not depicted in Figure 1, include:

- two underground high-pressure gas filled (HPGF) 115-kV circuits in pipe-type cables, which proceed north beneath Bridgeport Harbor; and
- one cross-linked polyethylene (XLPE) 115-kV circuit, having 3 cables per phase in the ducts of an underground duct bank, which proceeds from UI's Singer Substation along Ferry Access Road and Main Street, parallel to the route of the existing 345 kV double circuit Middletown-Norwalk underground transmission cables.

In addition to the above-mentioned transmission circuits, distribution cables in underground duct banks exit the Pequonnock Substation onto Ferry Access Road, and proceed north to an underground crossing of the MNR tracks.

The topology of the existing Pequonnock Substation and proposed Pequonnock Substation is nearly identical. The existing Pequonnock Substation is a 6-bay open-air-insulated breaker-and-a-half configuration. The proposed substation will consist of a 5-bay breaker-and-a-half Gas Insulated Substation (GIS) construction approximately 700 feet southwest of the existing site. One-line diagrams of the pre-Project and post-Project configurations can be seen in Figure 3 and Figure 4, respectively.

The proposed site is within an industrial area that is immediately bordered by industrial uses, the railroad corridor, and commercial (warehouse) type uses. The closest residential neighborhood is located on the west side of Main Street. The nearest proposed equipment is approximately 480 feet from the closest single-family dwelling to the southwest.

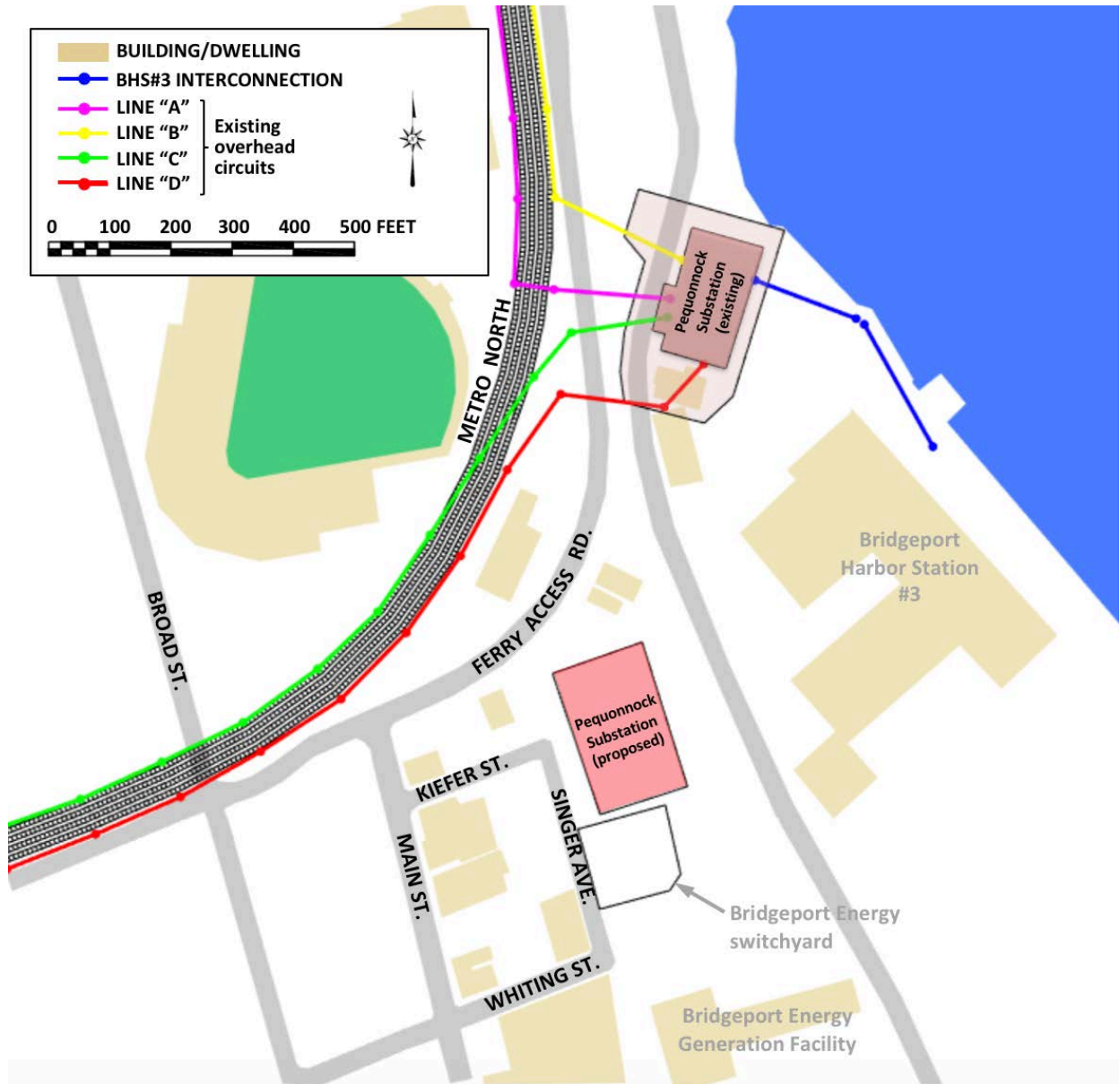

Figure 1. Plan view of the existing Pequonnock Substation and surrounding area, showing the location of existing overhead 115-kV circuits on the adjacent ROW. The Bridgeport Energy Interconnection is not in service and therefore not shown.

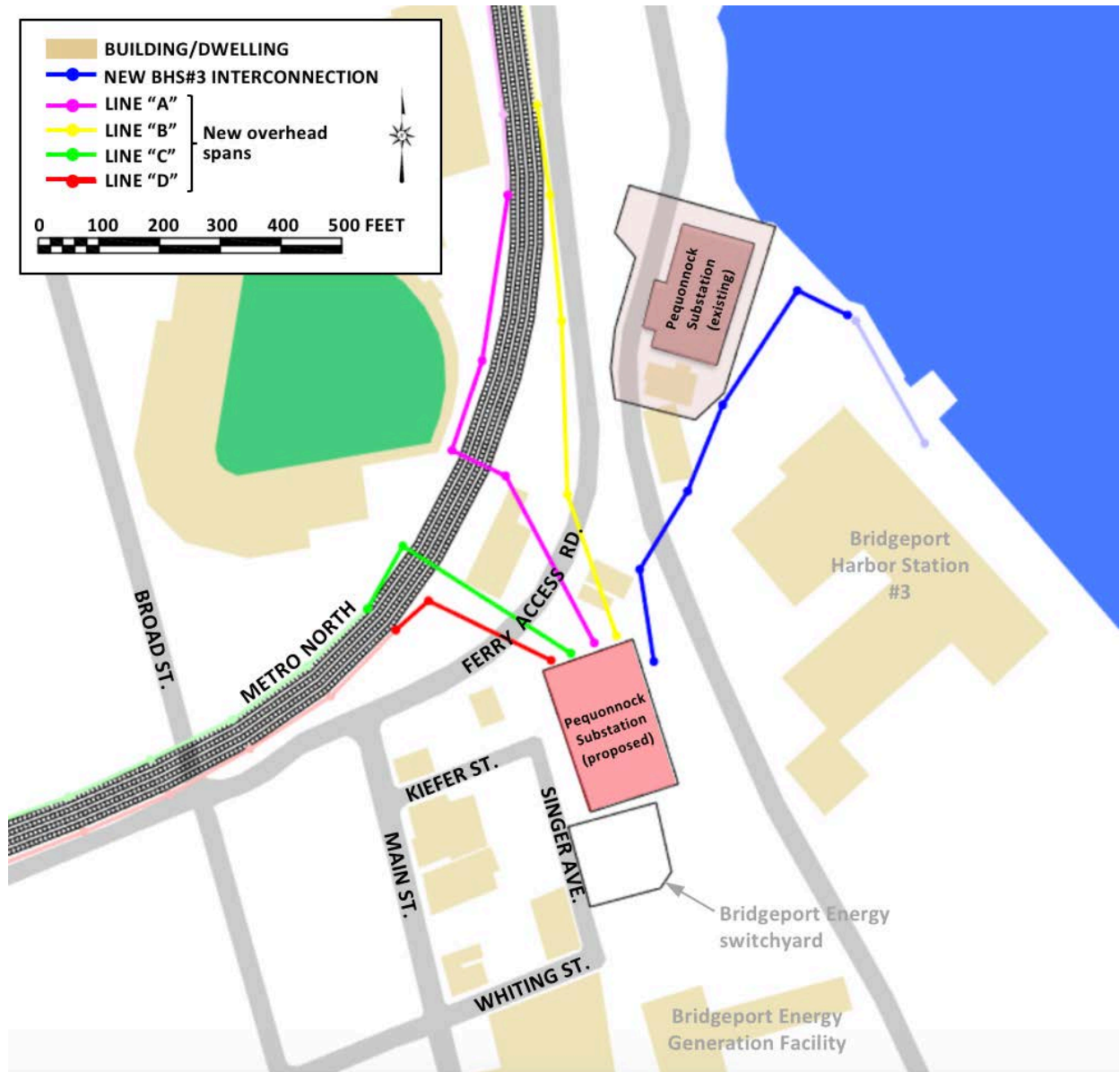

Figure 2. Plan view of the proposed Pequonnock Substation and surrounding area, showing the repositioned spans of the overhead 115-kV circuits on the adjacent ROW.

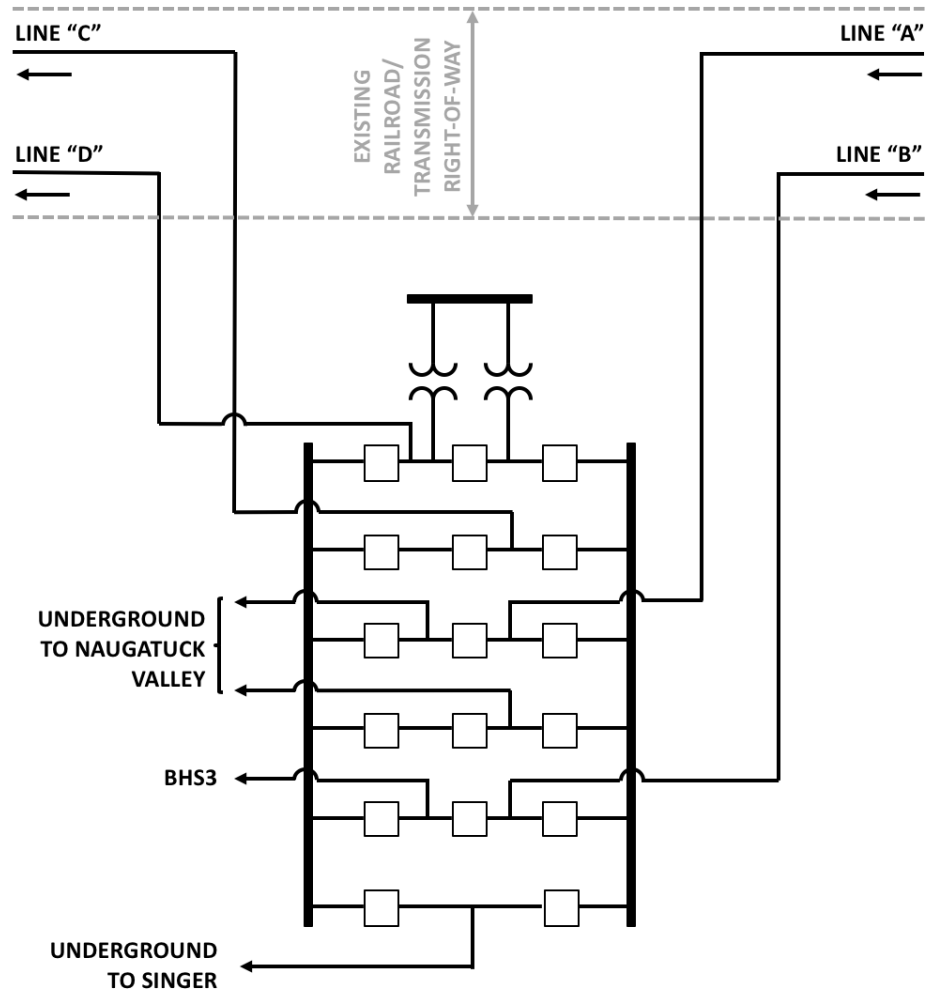

Figure 3. One-line diagram of the existing 115-kV transmission system showing overhead and underground circuits terminating at the existing Pequonnock Substation. The reference direction of current flow on the overhead transmission lines is depicted.

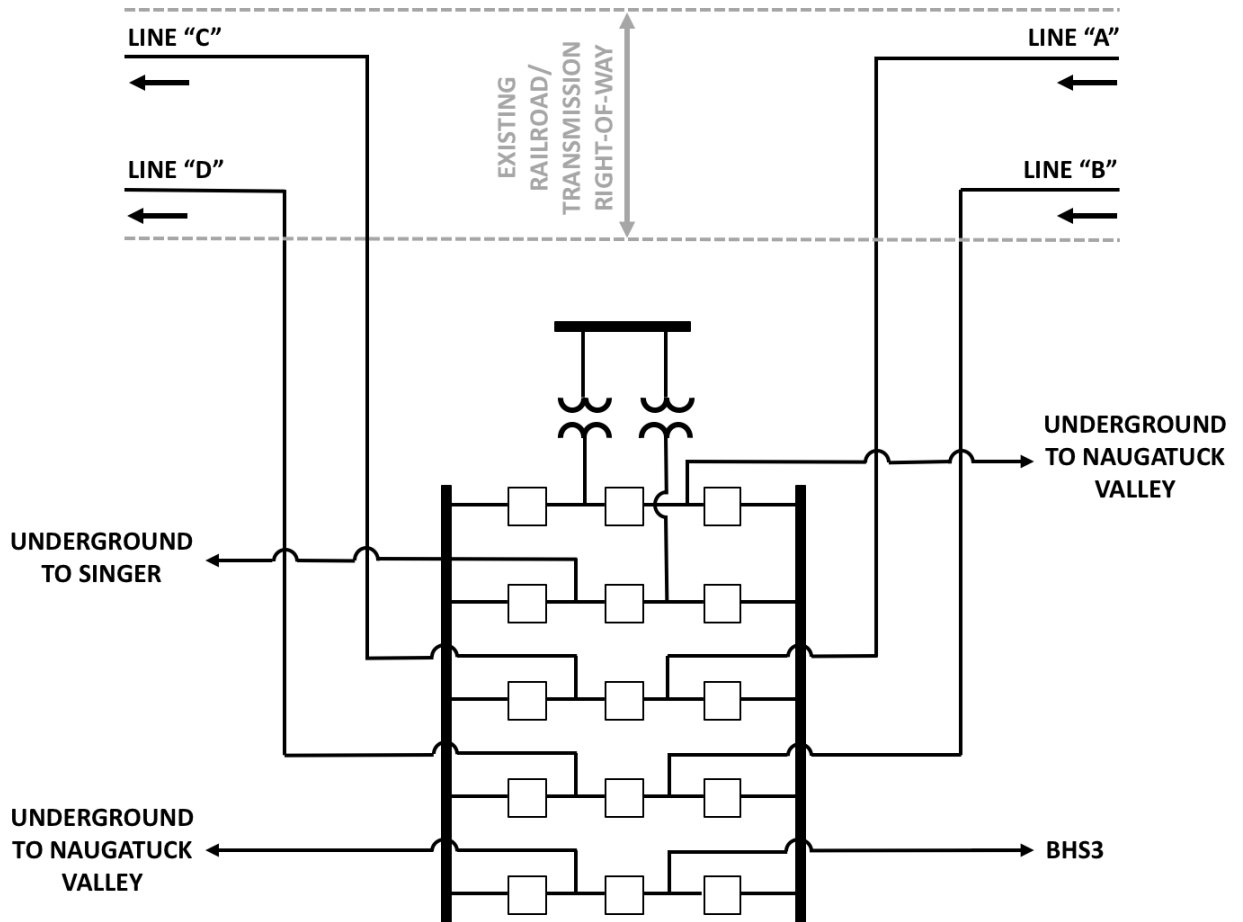

Figure 4. One-line diagram of the proposed 115-kV transmission system showing overhead and underground circuits terminating at the proposed Pequonnock Substation.

Technical Background

Magnetic Fields. The current flowing in the conductors of a substation bus-line or an overhead transmission line generates a magnetic field near the conductor. The strength of project-related magnetic fields in this report are expressed as magnetic flux density in units of milligauss (mG), where 1 Gauss (G) = 1,000 mG. In the case of alternating current (AC) transmission lines, these currents (and thus magnetic fields) vary in direction and magnitude with a 60-Hertz (Hz) cycle. Since load currents—expressed in units of amperes (A)—generate magnetic fields around the conductors, measurements or calculations of the magnetic field present a snapshot for the load conditions at only one moment in time. On a given day, throughout a week, or over the course of months and years, the magnetic-field level can change depending upon the patterns of power demand on the bulk transmission system.

Electric Fields. The voltage on the conductors of transmission lines generates an electric field in the space between the conductors and the ground. Many objects are conductive—including fences, shrubbery, and buildings—and thus shield electric fields. Electric fields within the Pequonnock Substation therefore are not calculated since they are likely to be blocked by the substation fence. In addition, the buried distribution lines will not be a source of 60-Hz electric fields above ground, since electric fields are confined by the cables' conductive sheath and armor, as well as blocked by the surrounding soil and duct bank. In this report, electric-field levels are calculated for the transmission lines and are expressed in units of kilovolts per meter (kV/m)—1 kV/m is equal to 1,000 volts per meter (V/m).

Electricity is an integral part of our infrastructure (e.g., transportation systems) and our homes and businesses, and people living in modern communities are therefore surrounded by sources of EMF. Figure 5 depicts typical magnetic-field levels measured in residential and occupational environments, compared to levels measured on or at the edge of transmission line ROWs.

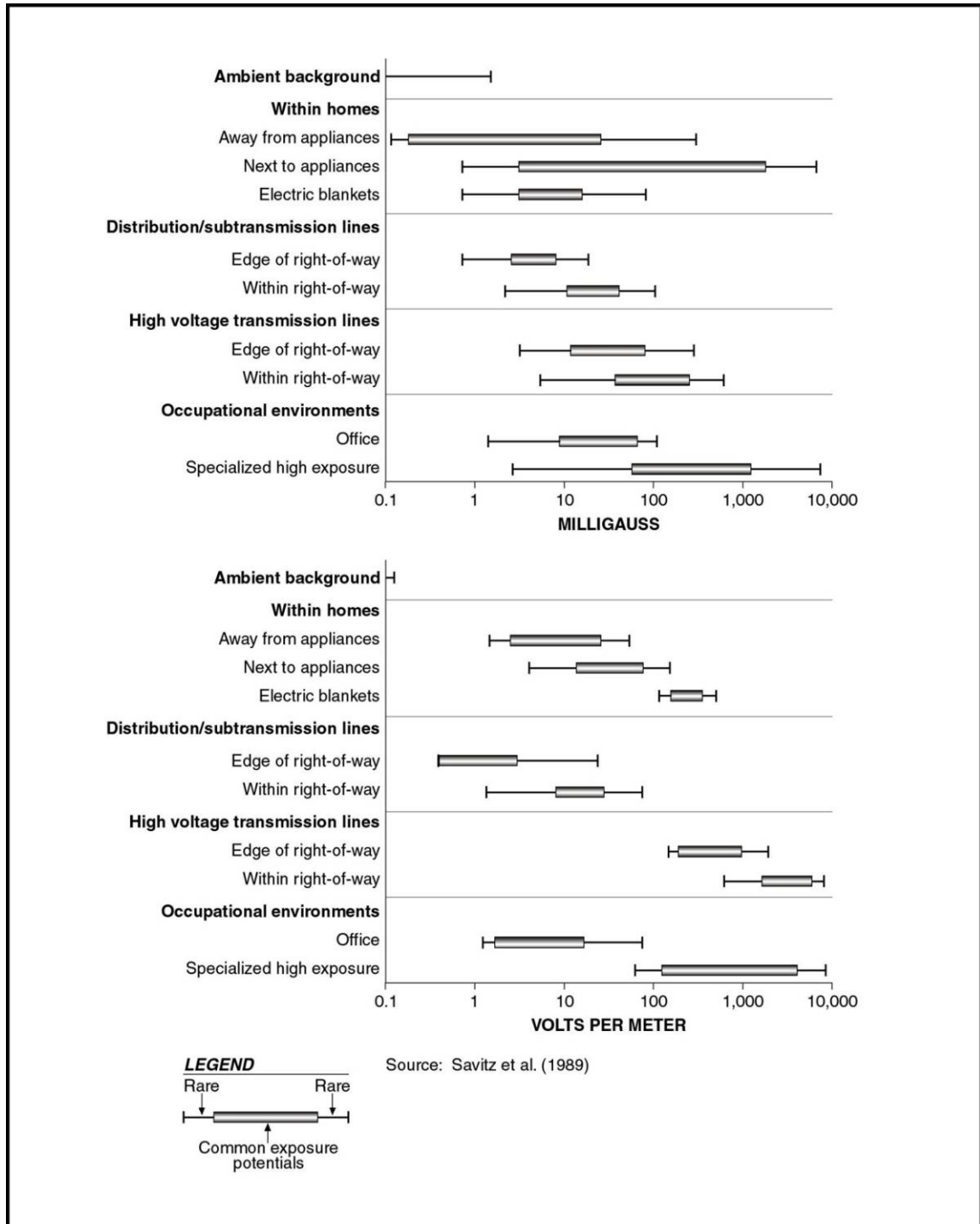

Figure 5. Electric- and magnetic-field levels in the environment.

Measurement and Modeling Profiles

Measurements of electric- and magnetic-field (EMF) levels from existing sources at the proposed boundaries of the new Pequonnock Substation were taken on November 15, 2017, to assess pre-Project conditions. The results of these measurements are summarized in the following sections.

Exponent created electrical models of the existing and proposed configurations of the transmission system to examine magnetic-field levels in the vicinity of the Project. In addition to calculations of magnetic fields around the property line and fence of the existing and proposed substations, Exponent calculated the magnetic field along six profiles in the vicinity of the Project (see Figure 6).

Profile 1 starts at southeast corner of the intersection of Broad St. and Ferry Access Road, and proceeds due west, following the curve of Ferry Access Road to the north/

Profile 2 runs west from the fence of the existing Pequonnock Substation, crossing Ferry Access Road and the MNR tracks to the west.

Profile 3 runs north from the fence of the proposed Pequonnock Substation, crossing Ferry Access Road to the north.

Profile 4 begins on the west side of the proposed Pequonnock Substation, and proceeds west on the north side of Kiefer Street.

Profile 5 starts at the proposed substation fence near the southwest corner, and proceeds southwest towards the residences on the west side of Main Street.

Profile 6 starts west of the proposed Pequonnock substation, and transects the existing railroad/transmission-line ROW from south to north.

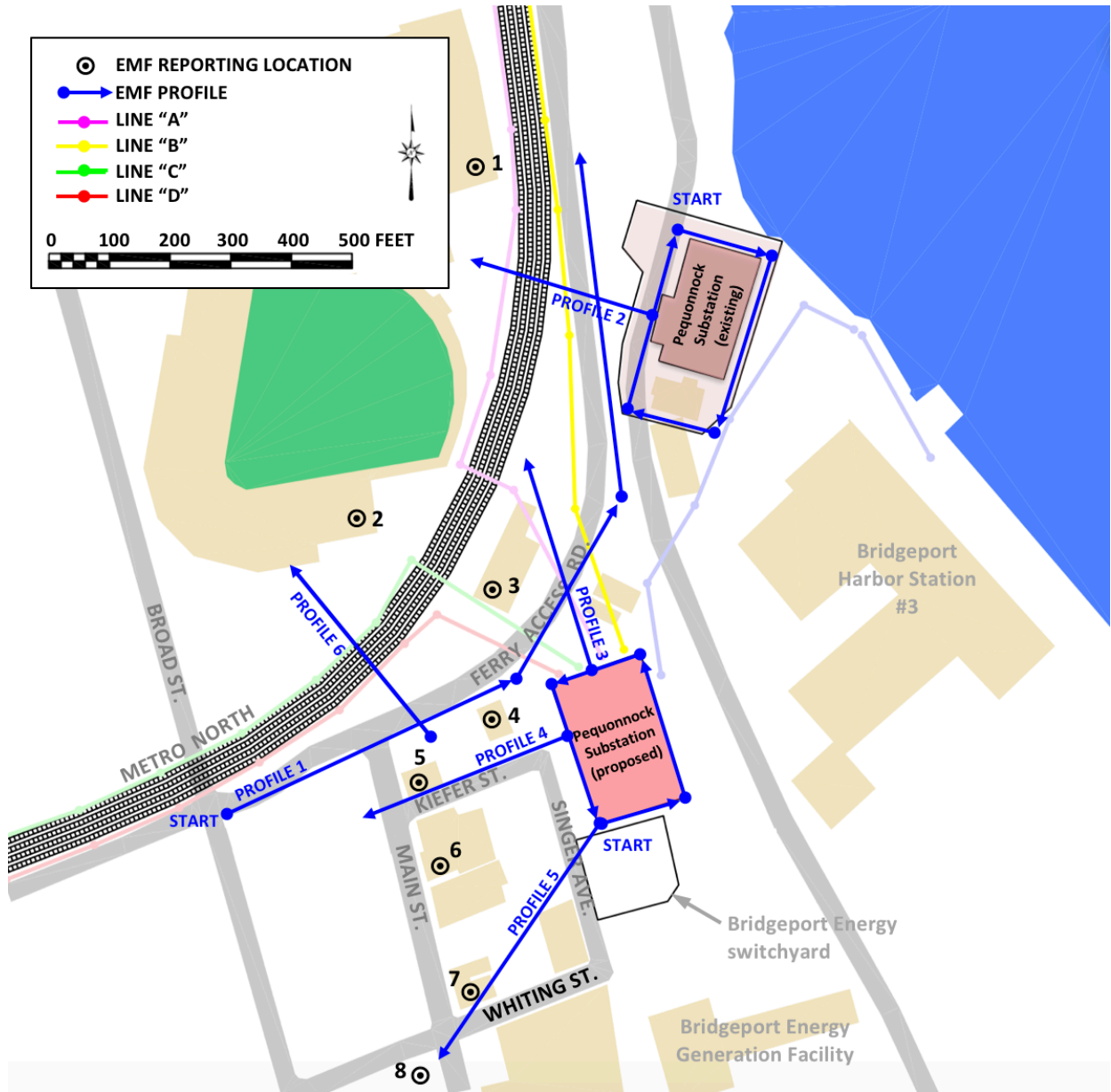

Figure 6. Plan view of the Project vicinity, showing existing and proposed substation yards and the location of calculated profiles.

The existing location of overhead 115-kV circuits on the adjacent ROW also is depicted.

On the MNR corridor directly northwest of the existing Pequonnock Substation, the overhead circuits A through D are mounted on catenary structures of the New Haven Line. In the existing configuration, these circuits have predominantly a delta configuration with an approximate 10-foot spacing between the phase conductors. In addition, two existing 115 kV circuits (lines C

and D) are supported on vertical monopoles between the MNR corridor and the existing Pequonnock Substation.

Assessment Criteria

Neither the federal government nor the State of Connecticut has enacted standards for magnetic fields or electric fields from power lines or other sources at power frequencies although the Connecticut Siting Council has developed guidelines for siting new transmission lines as discussed in a subsequent section of this report. Several other states have statutes or guidelines that apply to fields produced by new transmission lines, but these guidelines are not health based. For example, New York and Florida have limits on EMF that were designed to limit fields from new transmission lines to levels characteristic of the fields from existing transmission lines.

More relevant EMF assessment criteria include the exposure limits recommended by scientific organizations. These exposure limits are included in guidelines developed to protect health and safety and are based upon reviews and evaluations of relevant health research. These guidelines include exposure limits for the general public recommended by the International Committee on Electromagnetic Safety (ICES) and the International Commission on Non-Ionizing Radiation Protection (ICNIRP) to address health and safety issues.³

In a June 2007 Factsheet, the World Health Organization included recommendations that policy makers should adopt international exposure limit guidelines, such as those from ICNIRP or ICES (Table 1), for occupational and public exposure to EMF.⁴

³ International Committee on Electromagnetic Safety (ICES). IEEE Standard for Safety Levels with Respect to Human Exposure to Electromagnetic Fields 0 to 3 kHz. Piscataway, NJ: IEEE, 2002; International Commission on Non-ionizing Radiation Protection (ICNIRP). Guidelines for limiting exposure to time-varying electric and magnetic fields (1 Hz to 100 kHz). Health Phys 99: 818-836, 2010.

⁴ World Health Organization (WHO). Fact Sheet No. 322: Electromagnetic Fields and Public Health – Exposure to Extremely Low Frequency Fields. Geneva, Switzerland: World Health Organization, 2007.

Table 1. ICNIRP and ICES guidelines for EMF exposure at 60-Hz

	Exposure (60 Hz)	
	Electric Field	Magnetic Field
ICNIRP		
Occupational	8.3 kV/m	10 G (10,000 mG)
General Public	4.2 kV/m	2 G (2,000 mG)
ICES		
Occupational	20 kV/m	27.1 G (27,100 mG)
General Public	5 kV/m*	9.040 G (9,040 mG)

*Within power line ROWs, the guideline is 10 kV/m under normal load conditions.

Methods

Measurements

EMF levels around the existing configuration of the Pequonnock Substation, fields were characterized by taking measurements outside the existing substation fence on November 15, 2017. The measurements were taken at a height of 1 meter (3.28 feet) above ground in accordance with the standard methods for measuring near power lines.⁵ Both electric fields and magnetic fields were expressed as the total field computed as the resultant of field vectors measured along vertical, transverse, and longitudinal axes.⁶ The electric field was measured in units of kV/m with a single-axis field sensor and meter manufactured by Enertech Consultants. The magnetic field was measured in units of mG by orthogonally-mounted sensing coils whose output was logged by a digital recording meter (EMDEX II) manufactured by Enertech Consultants. These instruments meet the Institute of Electrical and Electronics Engineers (IEEE) instrumentation standard for obtaining accurate field measurements at power line frequencies.⁷ The meters were calibrated by the manufacturer by methods like those described in IEEE Std. 644-2008, “*IEEE Standard Procedures for Measurement of Power Frequency Electric and Magnetic Fields from AC Power Lines.*”

Magnetic-Field Modeling

Exponent modeled magnetic-field levels associated with the existing and proposed configurations of the Pequonnock Substation and the existing 115-kV transmission lines using SUBCALC. SUBCALC, part of the Enertech EMF Workbench Suite, was used to model the

⁵ Institute of Electrical and Electronics Engineers (IEEE). IEEE Standard Procedures for Measurement of Power Frequency Electric and Magnetic Fields from AC Power Lines (ANSI/IEEE Std. 644-2008). New York: IEEE, 2008.

⁶ Measurements along the vertical, transverse, and longitudinal axes were recorded as root-mean-square magnitudes. Root mean square refers to the common mathematical method of defining the effective voltage, current, or field of an AC system.

⁷ Institute of Electrical and Electronics Engineers (IEEE). IEEE Recommended Practice for Instrumentation: Specifications for Magnetic Flux Density and Electric Field Strength Meters – 10 Hz to 3 kHz (IEEE Std. 1308-1994). New York: IEEE, 1994.

magnetic fields in and around substation equipment, and accounts for the three-dimensional arrangement of breakers, transformers, reactors, capacitors, buswork, and transmission lines.

Two SUBCALC models were constructed using the substation plan and profile data, and accounting for the elevated grade of the MNR corridor. The inputs to the program include data regarding voltage, current flow, circuit phasing, and conductor configurations, which were provided by UI.

The first SUBCALC model calculated magnetic fields for the existing configuration of the Pequonnock Substation, and included terminations of overhead and underground transmission lines (Figure 7). The second SUBCALC model included new transmission-line terminations at the proposed substation (Figure 8). The average-load conditions in 2027 and peak-load conditions in 2018 were used to calculate magnetic fields for both models, as discussed further below. Based on these two models, changes in the calculated magnetic fields associated with the operation of the Project are provided in the Results section.

Along each profile and perimeter, magnetic-field levels were calculated at 1 meter (3.28 feet) above ground as the root-mean-square value of the field in accordance with IEEE Std. C95.3.1-2010 and IEEE Std. 644-2008.⁸ Calculated magnetic-field levels are reported as resultant quantities in units of mG.⁹ Electric fields from the Pequonnock Substation were not modeled because the gas-insulated buswork and metallic fence enclosing the substation will effectively block the electric field associated with energized equipment.

⁸ Institute of Electrical and Electronics Engineers (IEEE). IEEE Recommended Practice for Measurements and Computations of Electric, Magnetic, and Electromagnetic Fields with Respect to Human Exposure to Such Fields, 0 Hz to 100 kHz (IEEE Std. C95.3.1-2010). New York: IEEE, 2010; Institute of Electrical and Electronics Engineers (IEEE). IEEE Standard Procedures for Measurement of Power Frequency Electric and Magnetic Fields from AC Power Lines (ANSI/IEEE Std. 644-2008). New York: IEEE, 2008.

⁹ The resultant magnetic field is the Euclidian norm (square root of the sum of the squares) of the component magnetic-field vectors calculated along vertical, transverse, and longitudinal axes.

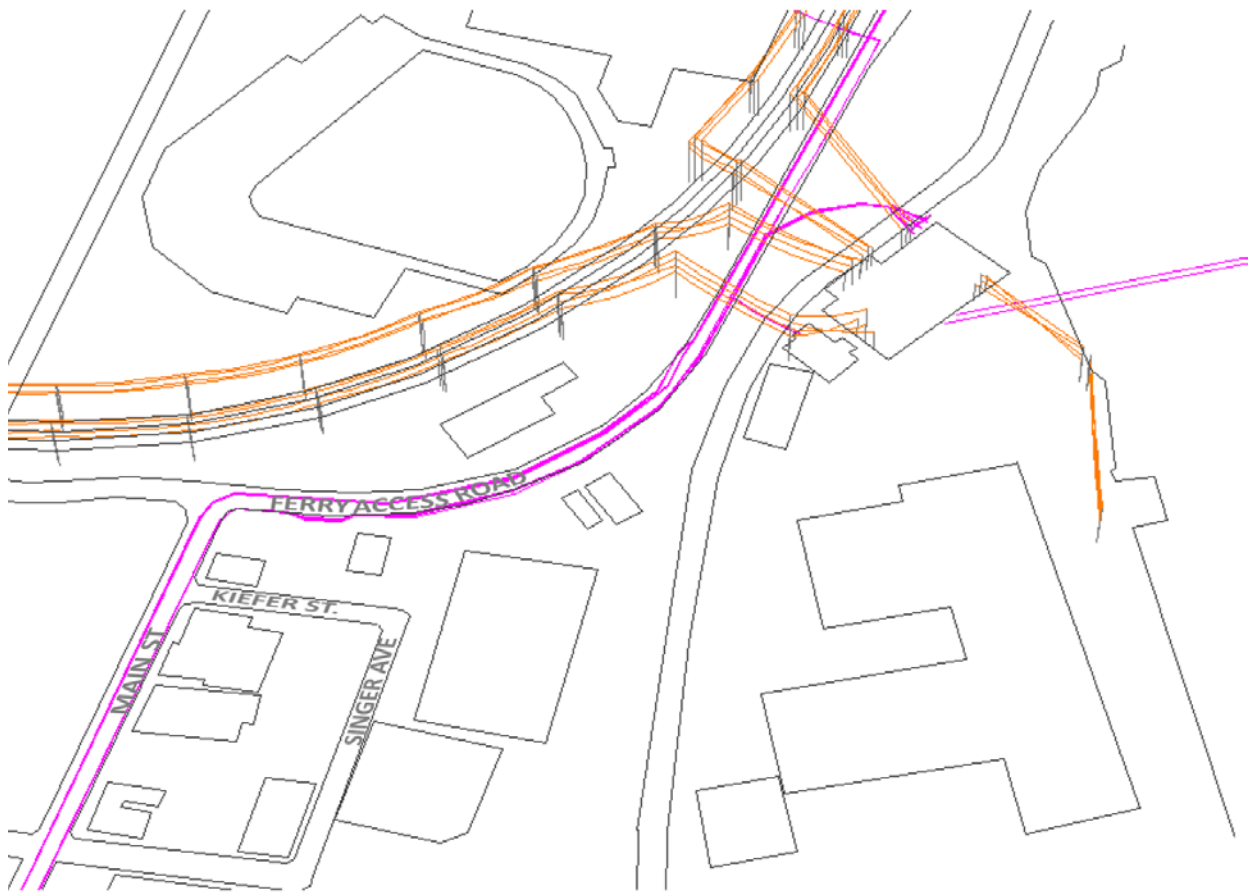

Figure 7. Overview of the three-dimensional SUBCALC model used to calculate magnetic fields for the existing Pequonnock Substation.

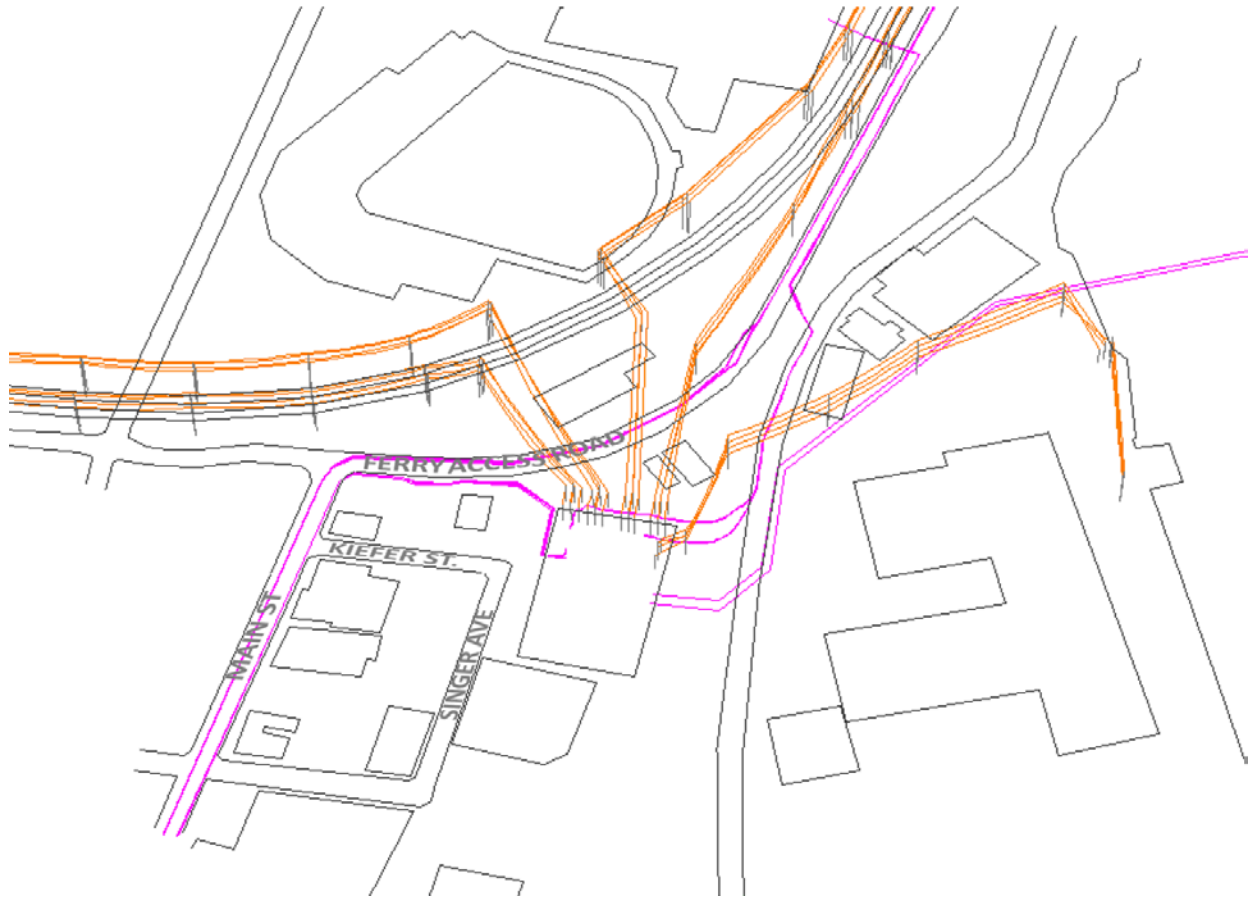

Figure 8. Overview of the three-dimensional SUBCALC model used to calculate magnetic fields for the proposed Pequonnock Substation, including repositioned 115-kV transmission lines on the adjoining ROW.

Loading

UI Transmission Planning provided the pre- and post-Project loadings for the 115-kV transmission lines and transformers involved in the Project. UI selected dispatches in such a way to stress the transmission corridor around the project area to cause the maximum current flows on the seven transmission lines terminating at the Pequonnock Substation. The current flows used for modeling are summarized in a table available from Exponent upon request, consistent with Critical Energy Infrastructure Information restrictions.

UI is required by the Connecticut Siting Council's (CSC) Electric and Magnetic Fields Best Management Practices (BMP) for the Construction of Electric Transmission Lines in Connecticut to provide line loadings for "pre and post project conditions, under: 1) peak load

conditions at the time of application filing, and 2) projected seasonal maximum 24-hour average current load on the line anticipated within five years after the line is placed into operation.”¹⁰

As provided by UI Transmission Planning, the term “seasonal maximum 24-hour average load level” was replaced by the term “peak daily average load.” In this report, “average load” refers to this case.

The project filing date, subsequent peak-load year, planned in-service date, and projected average daily peak-load year are as follows:

- CSC Filing: 2nd quarter of 2018
- Current Peak-Load Year: 2018
- Pequonnock Substation Rebuild In-Service: 2022
- Peak Daily Average Load Year: 2027¹¹

For peak-load analysis, UI modeled the system to reflect the topology of New England’s transmission system in the year 2018. In addition, the 2027 study year was modeled to satisfy the CSC requirement for obtaining EMF data for an average-load level within a five-year horizon of the in-service date. In order to determine the scenario with the highest line loadings, generation dispatches were chosen that caused the highest projected flows. As a conservative modeling approach, the model incorporated the highest total line-current magnitude anticipated in each transmission line separately.

¹⁰ Connecticut Siting Council (CSC). Electric and Magnetic Fields Best Management Practices for the Construction of Transmission Lines in Connecticut (Revised February 20, 2014). New Britain, CT: Connecticut Siting Council, 2014, p. 6.

¹¹ The load in New England is projected to increase for each of the five years following the project in-service date; therefore, the projected peak daily average load will occur during 2027.

Results and Discussion

Calculated magnetic fields for pre-Project and post-Project conditions are depicted in Figure 9 through Figure 17. Summary tables of magnetic-field levels calculated at various distances from the substation fence are provided in

Table 2 for the average-load case and in Table 3 for the peak-load case.

Perimeter Profiles

Figure 9 depicts the calculated magnetic-field level around the perimeter of the existing Pequonnock substation for average-load conditions in 2028. The perimeter path begins at the northwest corner of the substation, and proceeds clockwise along the north, east, south, and west sides of the yard. All portions around this site are restricted to members of the public.

The highest magnetic-field levels for the pre-Project profiles are encountered beneath the conductors of overhead transmission lines and above underground transmission cables. Near the terminations of underground cables near the northwest corner of the site, the highest calculated magnetic field is 750-900 mG. At other locations on the west side of the substation, the calculated magnetic fields near the termination of overhead conductors ranges between 55 mG and 100 mG. These observations are consistent with IEEE Standard 1127 which notes:

In a substation, the strongest fields near the perimeter fence come from the transmission and distribution lines entering and leaving the substation. The strength of fields from equipment inside the fence decreases rapidly with distance, reaching very low levels at relatively short distances beyond substation fences.¹²

Away from the transmission or distribution lines, especially on the east and south sides of the property, the calculated magnetic-field levels fall below 10 mG. Magnetic-field levels measured on November 15, 2017, are also depicted in Figure 9, and follow the same general trend as the pre-Project calculations.

Comparing the pre-Project and post-Project profiles in Figure 9, calculated magnetic-field levels are lower at the majority of locations around the perimeter of the existing Pequonnock substation. One exception to this trend is on the east side of the site, where the existing

¹² IEEE Guide for the Design, Construction, and Operation of Electric Power Substations for Community Acceptance and Environmental Compatibility (IEEE Std 1127-2013). New York: IEEE, p. 26.

overhead and underground circuit terminations will be rebuilt and extended southeast, toward the proposed site of the substation.

Figure 10 depicts the calculated magnetic-field level around the fence line of the proposed Pequonnock Substation for the average-load conditions in the year 2028. At the majority of locations, the pre-Project magnetic-field levels are lower than post-Project levels.¹³ Figure 10 shows that, consistent with expectations, the highest post-Project magnetic-field levels are beneath the conductors of overhead transmission lines and above underground XLPE transmission cables. In this case, the highest calculated magnetic-field level is 140 mG above the repositioned 115 kV underground circuit from the Singer Substation. The calculated magnetic fields are somewhat lower (50-100 mG) where new terminal conductors of Lines “A” through “D” pass above the fence of the proposed Pequonnock Substation.

Figure 11 depicts the calculated magnetic-field level along the same path as Figure 10 for the peak-load case in the year 2018. Comparing the average- and peak-load cases, the loading on the overhead lines “A” and “B” decreases and the loading on lines “C” and “D” increases. The magnitude of these changes is small, however, and as a result Figure 11 shows that the calculated magnetic fields beneath the overhead line terminations is between 45 mG and 115 mG.

Profiles 1-6

Calculated and measured magnetic-field levels along Profiles 1 – 6 are shown in Figure 12 through Figure 17. (See Figure 6 for the location of Profiles 1 – 6). Each figure shows pre-Project (noted as existing) and post-Project (noted as proposed) magnetic-field levels calculated for the average-load case.

¹³ Near the southwest corner of the proposed site, the measured and calculated magnetic fields (pre-Project) are higher than the post-Project levels due to sources in the Bridgeport Energy switchyard. These sources were not included in the SUBCALC model for the post-Project configuration.

Table 2 summarizes the calculated magnetic-field values in Figure 12 through Figure 17 at various distances from the profile starting point (e.g., the substation fence). Since the proposed site of the Pequonnock Substation is rebuilt to the south of the existing site, calculated magnetic-field levels are generally lower for post-Project conditions than for pre-Project conditions in profiles lying north (Profile 2, and the end of Profile 1). Conversely, in profiles farther south and nearer to the proposed substation (Profile 3, and the beginning of Profile 1), calculated magnetic-field levels are generally higher for post-Project conditions than for pre-Project conditions.

Profile 1 – On the south side of Ferry Access Road, the calculated profiles show that the magnetic-field sources having the same magnitude are shifted to the west with operation of the Project. Above the 115kV XLPE underground transmission circuit from the Singer Substation (and offset by approximately 20 feet from the existing 345 kV underground cables of Middletown-Norwalk Line), the calculated and measured magnetic field above the transmission cables is approximately 150 mG. In the pre-Project configuration, this underground source is located near the existing Pequonnock Substation, at approximately 1200 feet along Profile 1 as shown in Figure 12. In the post-Project configuration, this underground circuit is repositioned to exit north from the proposed site of the Pequonnock Substation (approximately 550 feet along Profile 1). Calculated magnetic fields from the overhead circuits range from 55 to 100 mG, and are likewise shifted west with operation of the Project.

Profile 2 – west of the existing Pequonnock Substation, existing 115 kV overhead and underground sources between the substation fence and Ferry Access Road will be relocated. As shown in Figure 13, the measured and calculated magnetic fields approach 110 mG east of Ferry Access Road in the pre-Project configuration. In the post-Project configuration, the calculated magnetic field levels east of Ferry Access Road are much lower, and range between 5 and 15 mG for average-load conditions. Above Ferry Access Road, calculated magnetic fields are approximately 50 mG both pre- and post-Project configurations. At this location, existing sources – including underground distribution circuits and the transmission cables – have loadings that are unchanged with operation of the Project.

Profile 3 – The Pre-Project magnetic-field levels along Profile 3 are significantly higher than post-Project magnetic-field levels at approximately 130 feet from the proposed substation fence (175 mG above Ferry Access Road in the pre-Project configuration, versus 75 mG post-Project. *See* Figure 14). This is due to 115 kV underground transmission cables that terminate at the existing Pequonnock Substation, which will be moved as part of the Project. North and south of Ferry Access Road, the calculated magnetic field levels (60-110 mG) are higher in the post-Project configuration. Here, Profile 3 runs parallel to the course of the new overhead spans of transmission lines “A” through “D.” These calculated magnetic fields are approximately the same as those measured beneath the transmission lines “A” through “D” at their existing locations (55 to 100 mG along Profile 1, as depicted in Figure 12).

Profile 4 – As shown in Figure 15, both pre-Project and post-Project magnetic-field levels along Profile 4 are similar. The increase at distances below 50 feet from the proposed substation fence is due to new transmission-line terminations that are proposed as part of the Project. Above Main Street, the calculated magnetic field levels for average-load conditions are approximately 50 mG, before and after operation of the Project. At this location, existing sources – including underground distribution circuits and the transmission cables – have loadings that are unchanged with operation of the Project.

Profile 5 – As shown in Figure 16, Profile 5 has the same features as Profile 4. Immediately southwest of the proposed substation, the measured magnetic fields are higher (50 mG) than the calculated magnetic fields in the post-Project configuration. This difference is due to sources within the Bridgeport Energy switchyard, which were not included in Exponent’s SUBCALC model for the proposed substation. Near the intersection of Main Street and Whiting Street, the calculated magnetic field levels for average-load conditions are approximately 50 mG, before and after operation of the Project. At this location, existing sources – including 115-kV underground transmission cables between the Pequonnock and Singer Substations and 345-kV underground transmission cables of the Middletown-Norwalk Project – have loadings that are unchanged with operation of the Project. These results show that at the nearest single-family dwelling (at the southwest corner of Main

Street and Whiting Street), the rebuild/relocation of the Pequonnock Substation will have essentially no effect on the calculated magnetic-field levels.

Profile 6 – The path of Profile 6 transects the railroad/transmission line ROW, and calculated magnetic-field levels along this profile are nearly identical before and after operation of the Project (Figure 17). These results show that though the proposed location of the Pequonnock Substation is approximately 700 feet south of its existing location, the loading of transmission lines terminating at the substation remains unchanged.

As noted above in the discussion of the perimeter of the proposed site (Figure 10 and Figure 11), the loading on the overhead transmission lines terminating at the Pequonnock Substation remains nearly unchanged between the average-load and peak-load cases. This similarity is also reflected in Table 3, which summarizes the calculated magnetic-field values for the peak-load case in Profiles 1 – 6. Comparing the entries in Table 2 and Table 3, the calculated magnetic-field levels differ by approximately 10% or less, reflecting the small changes in loading in Lines “A” through “D” in the peak-load case.

Structures and Buildings

Table 4 shows the magnetic field calculated at reporting locations 1 – 8 (see Figure 6), which are structures and dwellings in the vicinity of the Pequonnock Substation. Table 4 provides the calculated magnetic field levels at both average and peak loading, before and after operation of the Project. Closest to the existing ROW and north of the proposed substation (location 3), the increase in calculated magnetic field is approximately 16 mG for average-load conditions and 17 mG for peak-load conditions. This change reflects the relocation of lines “A” through “D” to cross Ferry Access Road north of the proposed site. Adjoining the proposed site of the Pequonnock Substation to the west, the calculated magnetic fields increase from 4.8 mG (pre-Project) to 6.9 mG (post-Project) for average-load conditions.

At other reporting locations, operation of the Project has a small effect on calculated magnetic fields. At structures and dwellings along Main Street, for instance, calculated magnetic fields before and after operation of the project differ by approximately 0.2 mG.

Electric Fields

Figure 18 depicts the location of electric-field measurements recorded on November 15, 2017. Measured electric-field values in three orthogonal axes are summarized in Table 5, along with calculated resultant quantities. The highest measured electric field in the (0.12 kV/m) was recorded beneath the conductors of the existing overhead terminations on the north side of the existing substation. At other locations in the surrounding community, and not directly beneath the overhead transmission conductors, the measured electric fields are quite low, typically below 0.03 kV/m.

Conclusions

As shown in the modeling results, the proposed Project will not significantly change magnetic-field levels surrounding the substation. Calculated pre-Project and post-Project magnetic fields are of approximately the same *magnitude* but have a different *location* due to the similar equipment and topography in the existing and proposed Pequonnock Substations, as well as the similar loading of the station under pre- and post-Project conditions. As a result, the calculated magnetic fields are nearly the same before and after operation of the Project, but are shifted westward with the proposed equipment.

As mentioned above, electricity is an integral part of our infrastructure (e.g., transportation systems), as well as our homes and businesses, and people living in modern communities are therefore surrounded by sources of EMF, as noted in Figure 5, which depicts typical magnetic-field levels measured in residential and occupational environments, compared to levels measured on or at the edge of transmission-line ROWs.

While magnetic-field levels decrease with distance from the source, any home, school, or office tends to have a background magnetic-field level as a result of the combined effect of numerous EMF sources. In general, the background magnetic-field level as estimated from the average of measurements throughout a house away from appliances is typically less than 4 mG, while levels can be hundreds of mG in close proximity to appliances. Comparing Figure 5 to the results discussed above, the calculated magnetic-field levels in the vicinity of both the pre-Project and post-Project configurations of the Pequonnock Substation are comparable in magnitude to the magnetic-field levels encountered in the vicinity of typical distribution lines and in homes and workplaces.

The largest calculated magnetic field in the Project vicinity is 150 mG, above the existing underground 115 kV XLPE circuit near Ferry Access Road. The calculated magnetic field decreases rapidly with distance from this circuit, and falls below 50 mG at distances of approximately 20 feet from the centerline of the underground cables. The highest measured electric field in the (0.12 kV/m) was recorded close to this location, beneath the conductors of

the existing overhead terminations on the north side of the existing substation. Electric-field levels will not differ appreciably around the proposed Pequonnock Substation since the configuration of equipment and overhead interconnections is similar to pre-Project conditions.

Both calculated magnetic-field levels and measured electric-field levels in the vicinity of the Pequonnock Substation are a small fraction of those recommended for the general public by international health-based standards (ICES and ICNIRP).

Consistency with CSC Best Management Practices

The Connecticut Siting Council adopted “EMF Best Management Practices for the Construction of Electric Transmission Lines in Connecticut” (BMP) in 2007 based upon a consensus of health and scientific agencies that the scientific evidence “reflects the lack of credible scientific evidence for a causal relationship between MF [magnetic field] exposure and adverse health effects.” (CSC, p. 3). Nevertheless, the CSC concluded that precautionary measures for the siting of new transmission lines in the state of Connecticut are appropriate and should include “the use of effective no-cost and low-cost technologies and management techniques on a project-specific basis to reduce MF [magnetic field] exposure to the public while allowing for the development of efficient and cost-effective electrical transmission projects” (CSC, p. 11).

The discussion below focusses on the CSC’s BMP (CSC, 2014) that pertains to the calculation of magnetic fields. Please note that the BMP explicitly applies to transmission lines, not substations. Despite this, Exponent has endeavored to meet the spirit of the BMP for transmission lines as interpreted for a substation. The Project does involve relocation of existing transmission lines, but otherwise the EMF from these lines post-Project will be similar to pre-Project conditions.

The models developed for the existing and proposed Pequonnock Substation configurations provided calculations of the magnetic fields at the Pequonnock Substation and from the interconnecting transmission lines based on BMP recommendations:

- Peak load conditions at the time of the application filing in 2018 and projected “average daily peak” in 2027;
- Consideration of any already approved changes to the electrical system; and,
- Calculations at a height of 1 meter (3.28 feet) above ground level.

Although no new transmission lines are part of the Project, calculations of EMF from existing lines and the relocated lines were provided because they are an existing adjacent background source of EMF. Despite the differences between the guidance applicable to substations and transmission lines, aspects of this project are consistent with the BMP applied to transmission lines and include:

- There are no adjacent statutory facilities where children might congregate around the proposed Pequonnock Substation; and
- UI selected the location for the relocated Pequonnock Substation in an industrial area, and the proposed terminations of overhead transmission lines have essentially no effect on the calculated magnetic field at dwellings in the surrounding community. For this reason, the proposed Project is consistent with “no-cost/low-cost designs that do not compromise system reliability or worker safety, or environmental and aesthetic project goals.”¹⁴

¹⁴ Connecticut Siting Council (CSC). Electric and Magnetic Fields Best Management Practices for the Construction of Transmission Lines in Connecticut (Revised February 20, 2014). New Britain, CT: Connecticut Siting Council, 2014, p. 6.

Table 2. Summary of calculated magnetic fields (mG) for Profiles 2 – 6 for average-load conditions in 2027

Profile	Heading	Modeling condition	Distance from proposed substation perimeter (ft)				
			0	100	150	200	300
2	west	Pre-Project	55.2	47.3	7.4	16.4	6.7
		Post-Project	4.7	9.9	12.7	15.7	0.8
3	north	Pre-Project	24.0	26.8	10.3	23.8	26.6
		Post-Project	95.9	75.6	73.2	76.1	17.5
4	west	Pre-Project	6.8	1.9	2.1	*56.8	3.6
		Post-Project	36.0	2.6	2.4	*57.2	3.8
5	southwest	Pre-Project	13.4	0.8	0.6	0.9	*12.8
		Post-Project	2.9	0.7	0.6	0.8	*12.8
6	north	Pre-Project	1.2	2.5	7.5	†24.2	†20.3
		Post-Project	1.2	2.5	7.5	†24.2	†20.3

† This location is near overhead 115-kV transmission lines on the adjoining ROW.

* This location is near underground transmission lines on Ferry Access Road or Main Street.

Table 3. Summary of calculated magnetic fields (mG) for Profiles 2 – 6 for peak-load conditions in 2018

Profile	Heading	Modeling condition	Distance from proposed substation perimeter (ft)				
			0	100	150	200	300
2	west	Pre-Project	45.3	44.7	6.5	12.4	5.2
		Post-Project	3.8	7.2	9.8	11.6	5.2
3	north	Pre-Project	24.0	26.6	11.3	27.7	29.9
		Post-Project	91.8	61.0	54.4	56.9	13.8
4	west	Pre-Project	6.9	2.1	2.4	*56.8	4.1
		Post-Project	36.0	2.8	2.8	*57.3	4.3
5	southwest	Pre-Project	13.4	0.8	0.7	0.9	*12.8
		Post-Project	2.9	0.7	0.6	0.8	*12.7
6	north	Pre-Project	1.4	2.9	8.0	†28.7	†22.2
		Post-Project	1.4	3.2	8.4	†28.7	†21.9

† This location is near overhead 115-kV transmission lines on the adjoining ROW.

* This location is near underground transmission lines on Ferry Access Road or Main Street.

Table 4. Summary of calculated magnetic fields (mG) at designated structures

Building designator*	Average Load		Peak Load	
	pre-Project	post-Project	pre-Project	post-Project
1	15.2	14.1	11.4	10.6
2	6.5	2.8	7.4	3.4
3	16.6	33.6	19.5	35.2
4	4.8	6.9	5.0	7.8
5	4.1	4.3	4.5	4.8
6	2.7	2.6	2.8	2.7
7	2.3	2.2	2.3	2.2
8	1.2	1.2	1.3	1.2

* The location of each building is shown in Figure 6.

Calculated and measured magnetic field perimeter of the existing Pequonnock substation

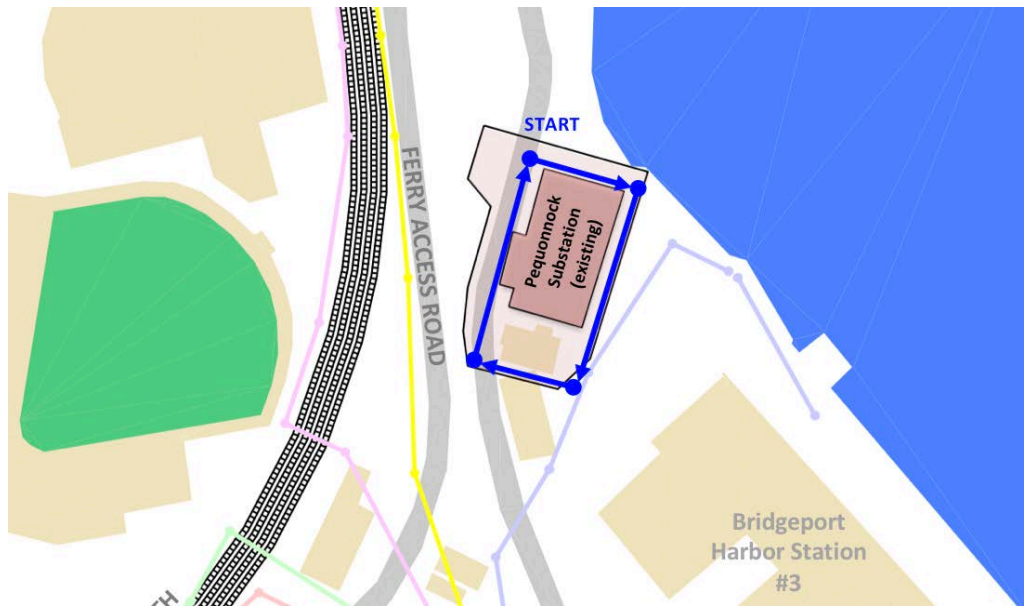
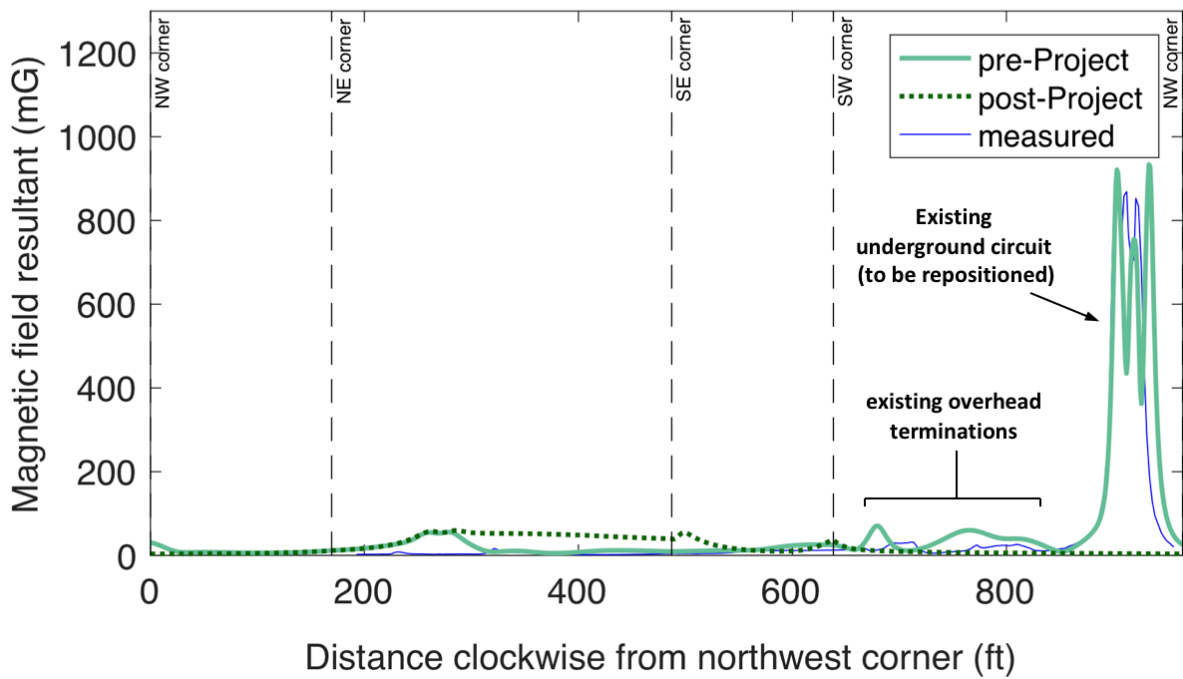

Figure 9. Measured and calculated magnetic-field profiles around the perimeter of the existing Pequonnock Substation sites for average-load conditions in the year 2027. Measured magnetic fields reflect existing substation and loading on November 15, 2017.

The profile begins at the northwest corner of the substation, and proceeds clockwise along the north, east, south, and west sides of the yard.

Calculated and measured magnetic field perimeter of the proposed Pequonnock substation

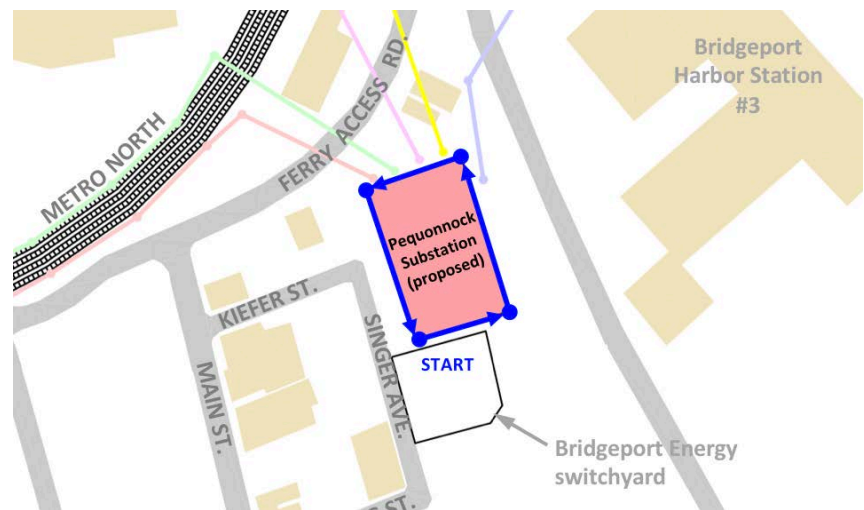
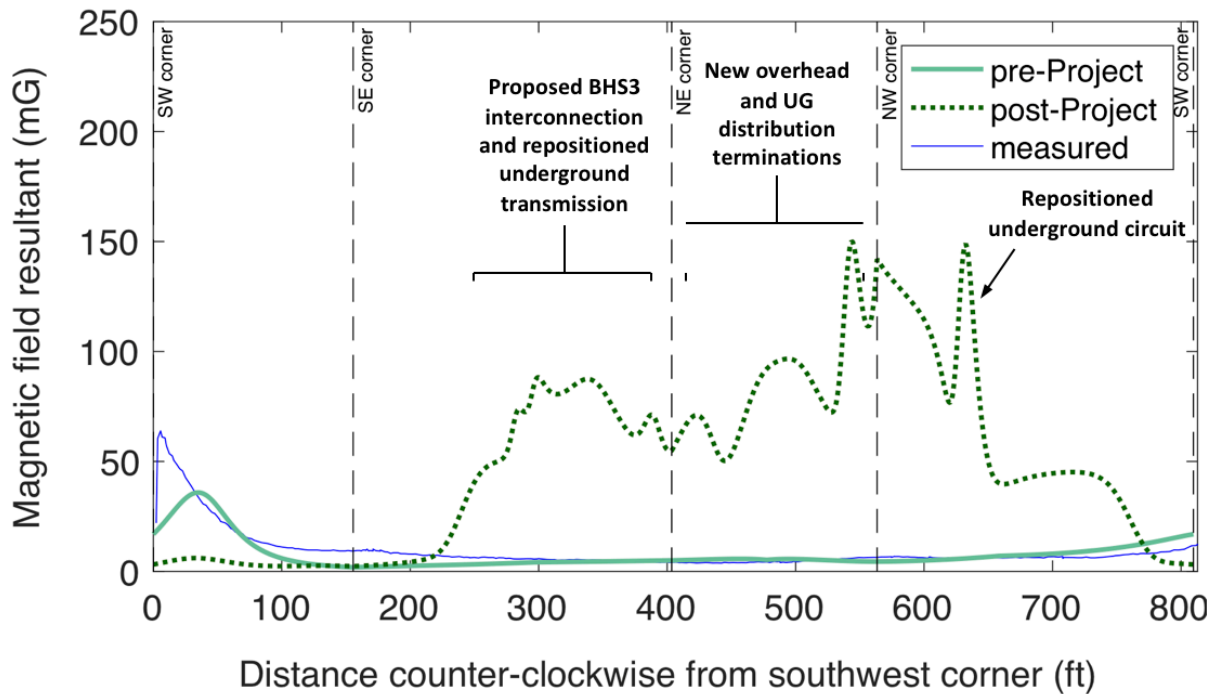

Figure 10. Measured and calculated magnetic-field profiles around the property line of the proposed Pequonnock Substation for average-load conditions in the year 2027. Measured magnetic fields reflect existing substation and loading on November 15, 2017.

The profile begins at the southwest corner of the substation, and proceeds counter-clockwise along the property line. The highest calculated magnetic fields are above the conductors of the underground circuits where they pass below the proposed perimeter of the substation.

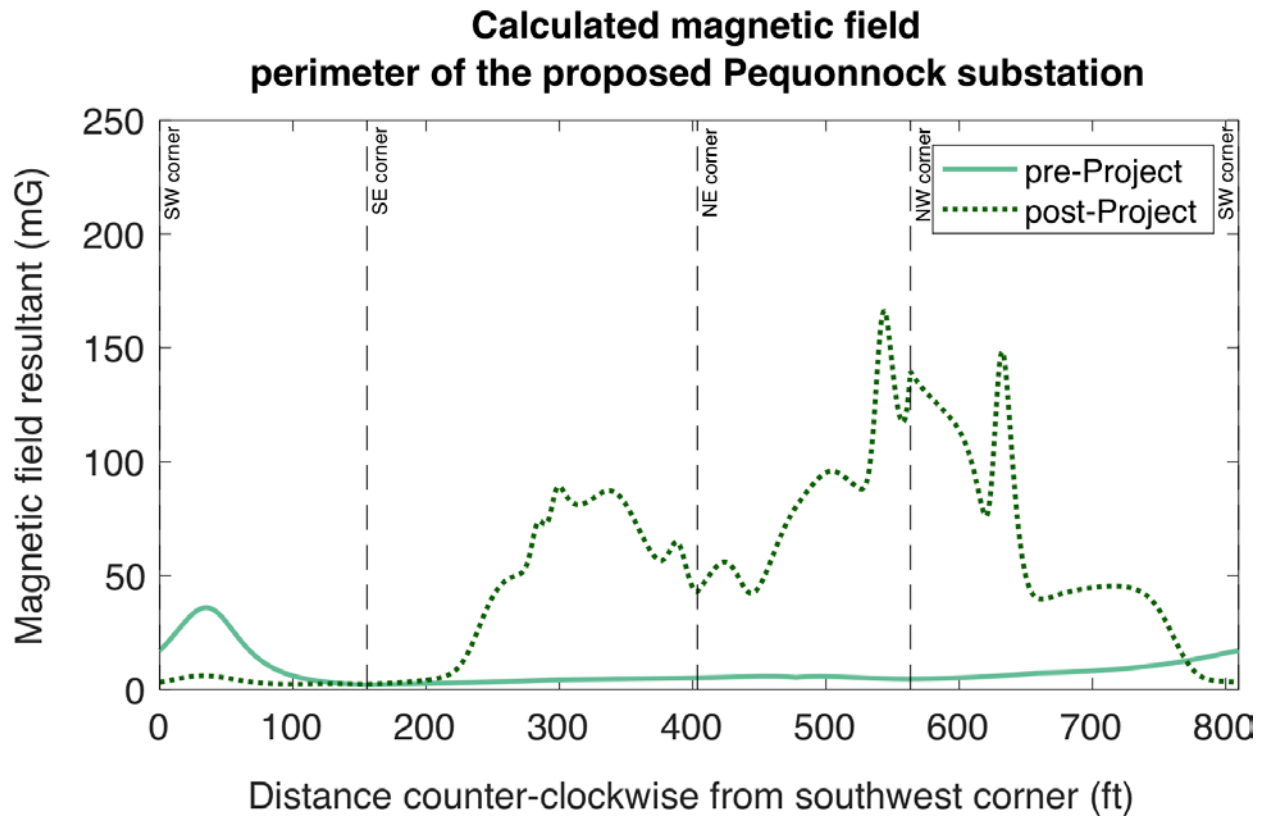

Figure 11. Calculated magnetic-field profiles around the property line of the proposed Pequonnock Substation for peak-load conditions in the year 2018.

Calculated and measured magnetic field Profile 1 (Ferry Access Road)

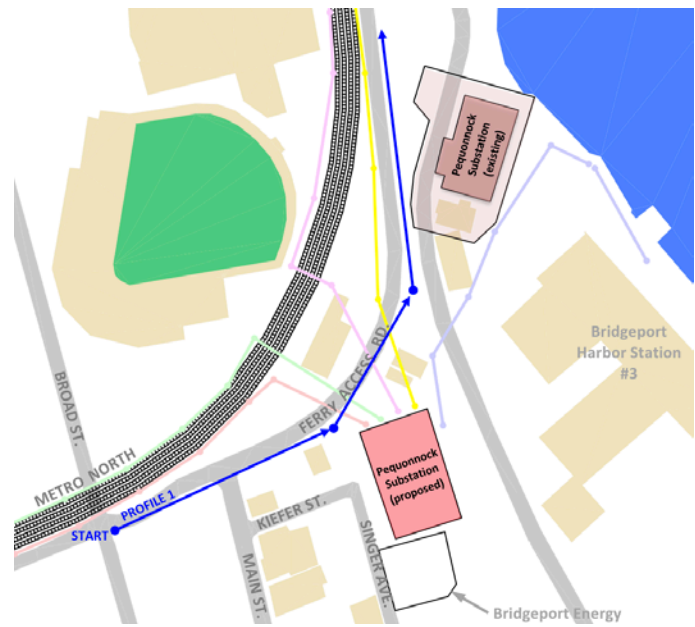
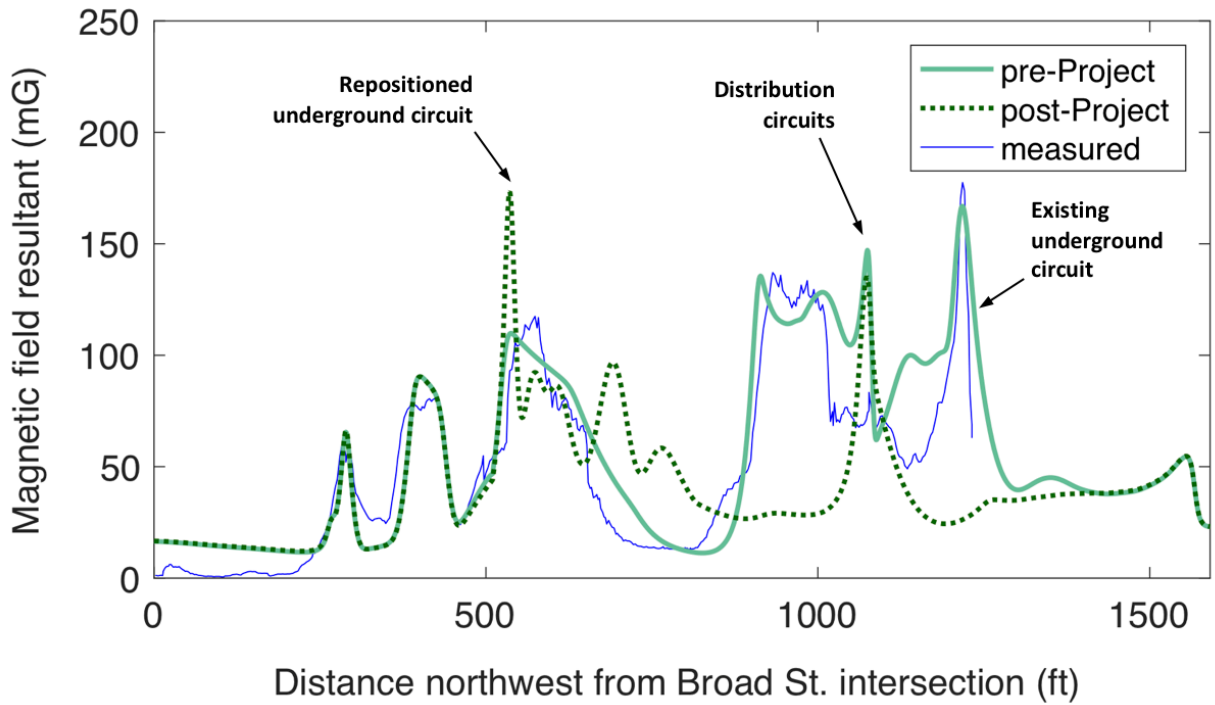

Figure 12. Calculated and measured magnetic-field levels along Profile 1.

The calculated magnetic-field levels are for existing and proposed configurations of the Pequonnock Substation under average-load conditions in 2027. Measured magnetic fields reflect existing substation and loading on November 15, 2017.

Calculated and measured magnetic field Profile 2 (West)

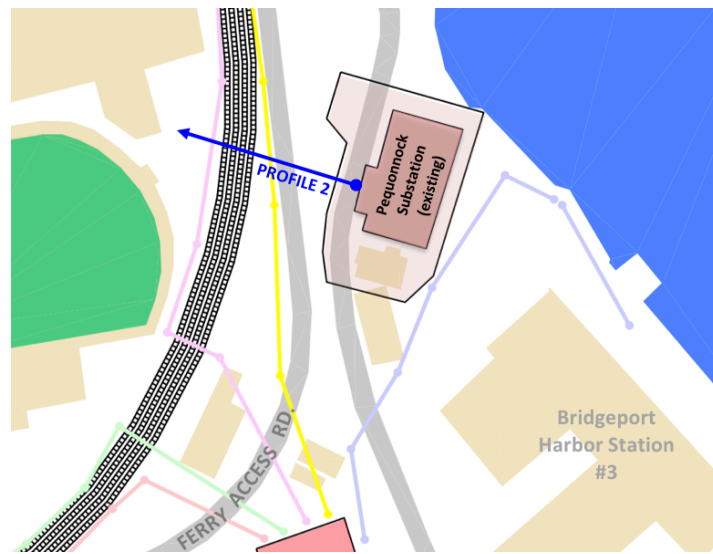
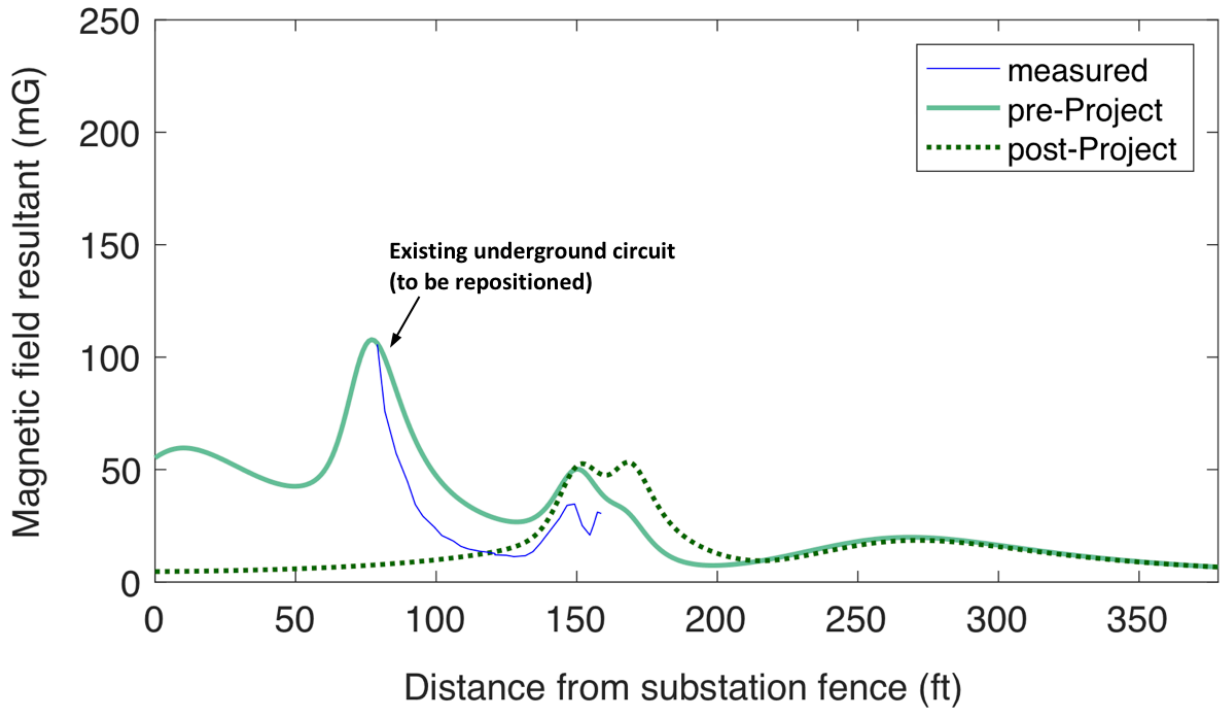

Figure 13. Calculated and measured magnetic-field levels along Profile 2.

The calculated magnetic-field levels are for existing and proposed configurations of the Pequonnock Substation under average-load conditions in 2027. Measured magnetic fields reflect existing substation and loading on November 15, 2017.

Calculated and measured magnetic field Profile 3 (North)

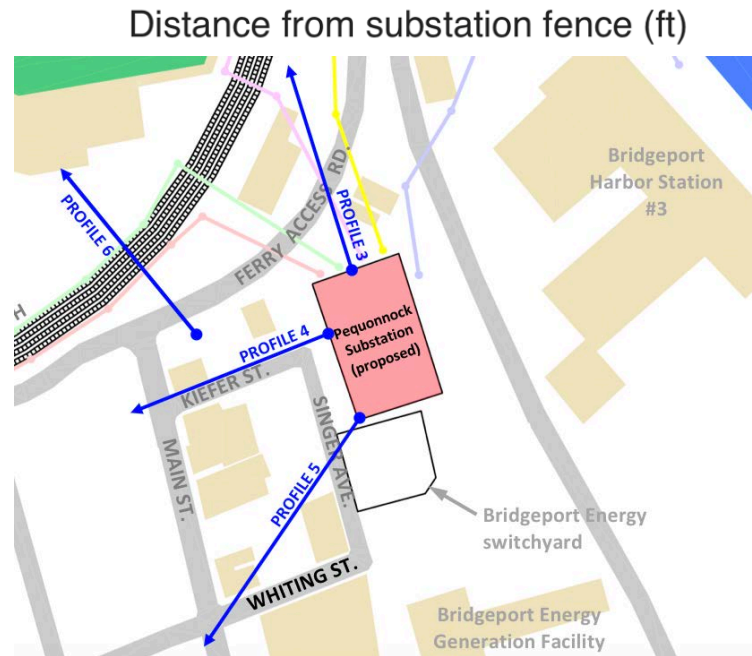
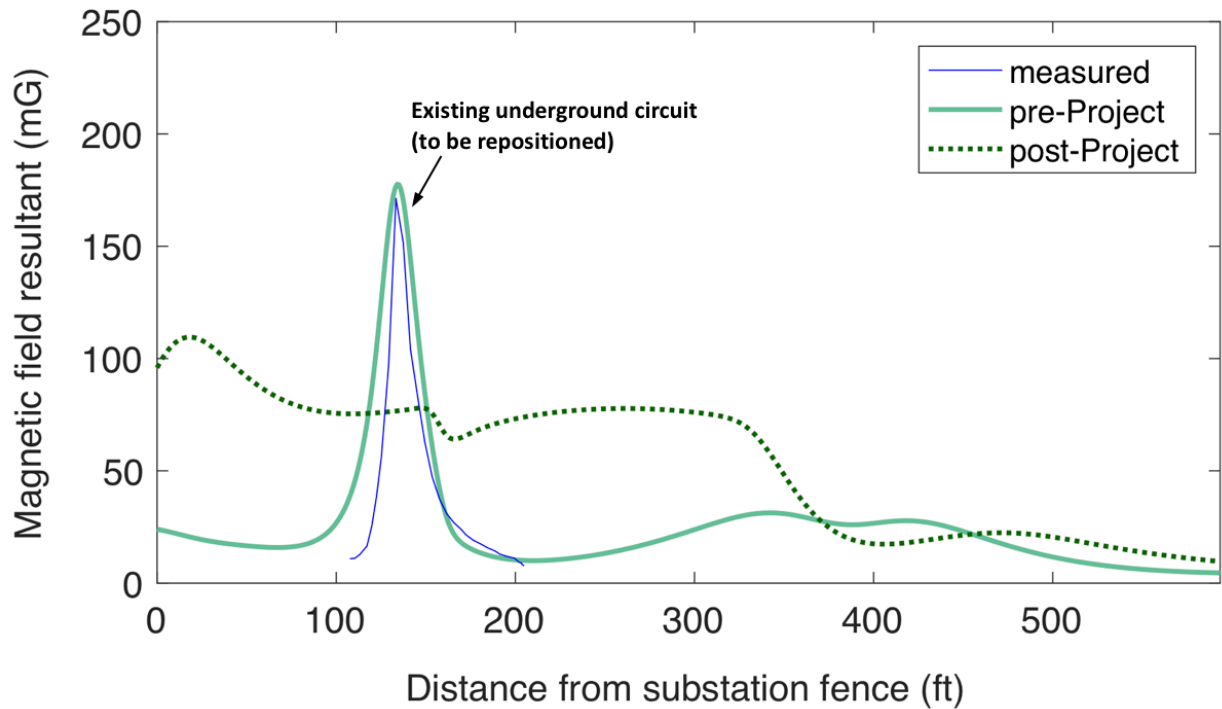

Figure 14. Calculated and measured magnetic-field levels along Profile 3.

The calculated magnetic-field levels are for existing and proposed configurations of the Pequonnock Substation under average-load conditions in 2027. Measured magnetic fields reflect existing substation and loading on November 15, 2017.

Calculated and measured magnetic field Profile 4 (West)

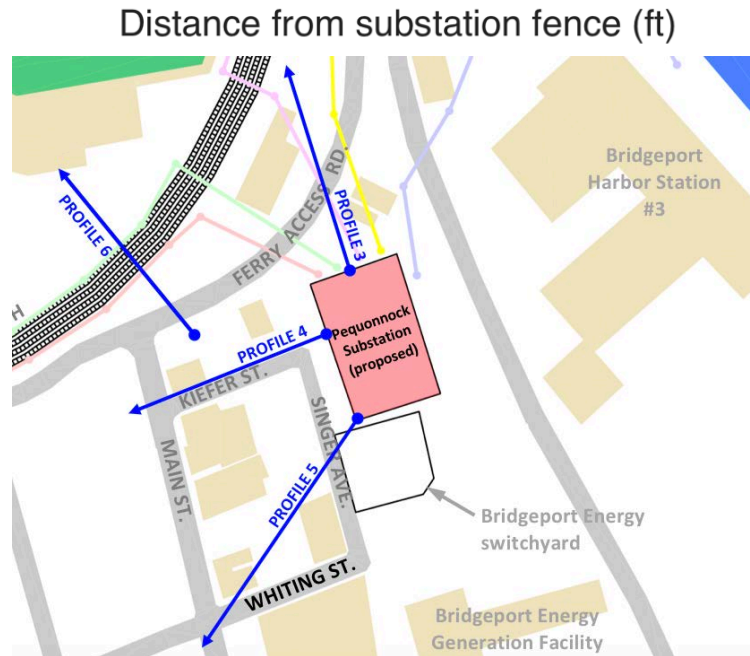
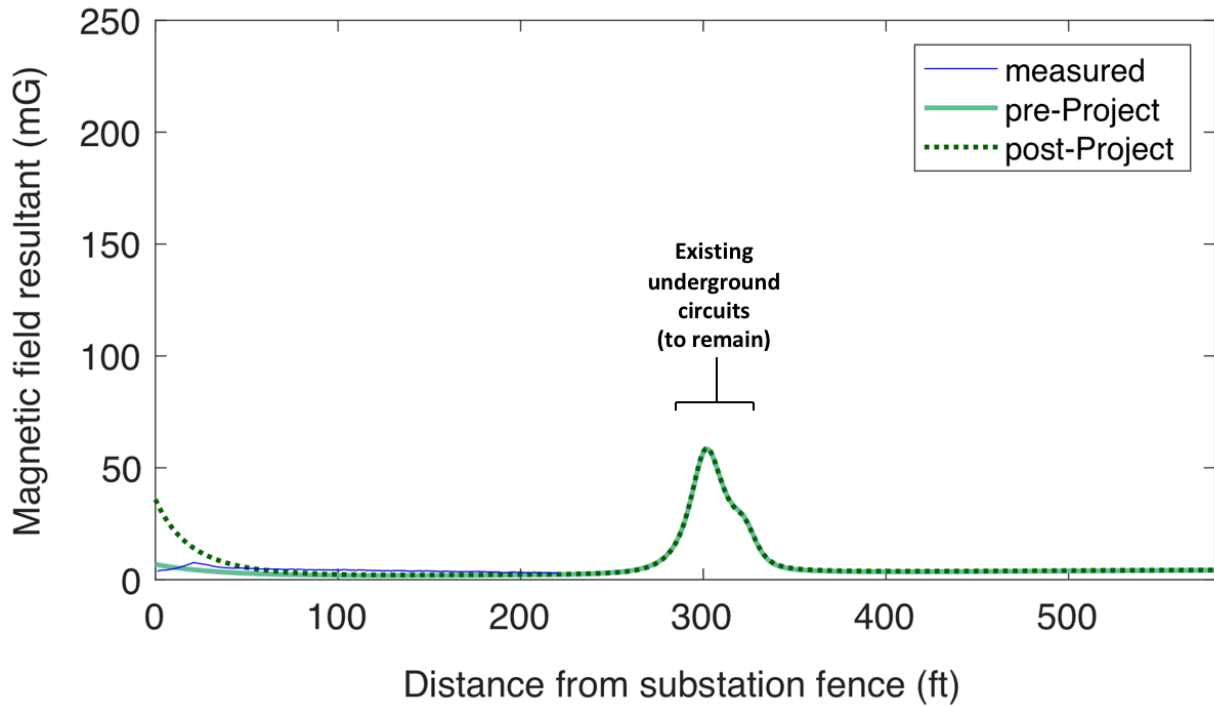

Figure 15. Calculated and measured magnetic-field levels along Profile 4.

The calculated magnetic-field levels are for existing and proposed configurations of the Pequonnock Substation under average-load conditions in 2027. Measured magnetic fields reflect existing substation and loading on November 15, 2017.

Calculated and measured magnetic field Profile 5 (Southwest)

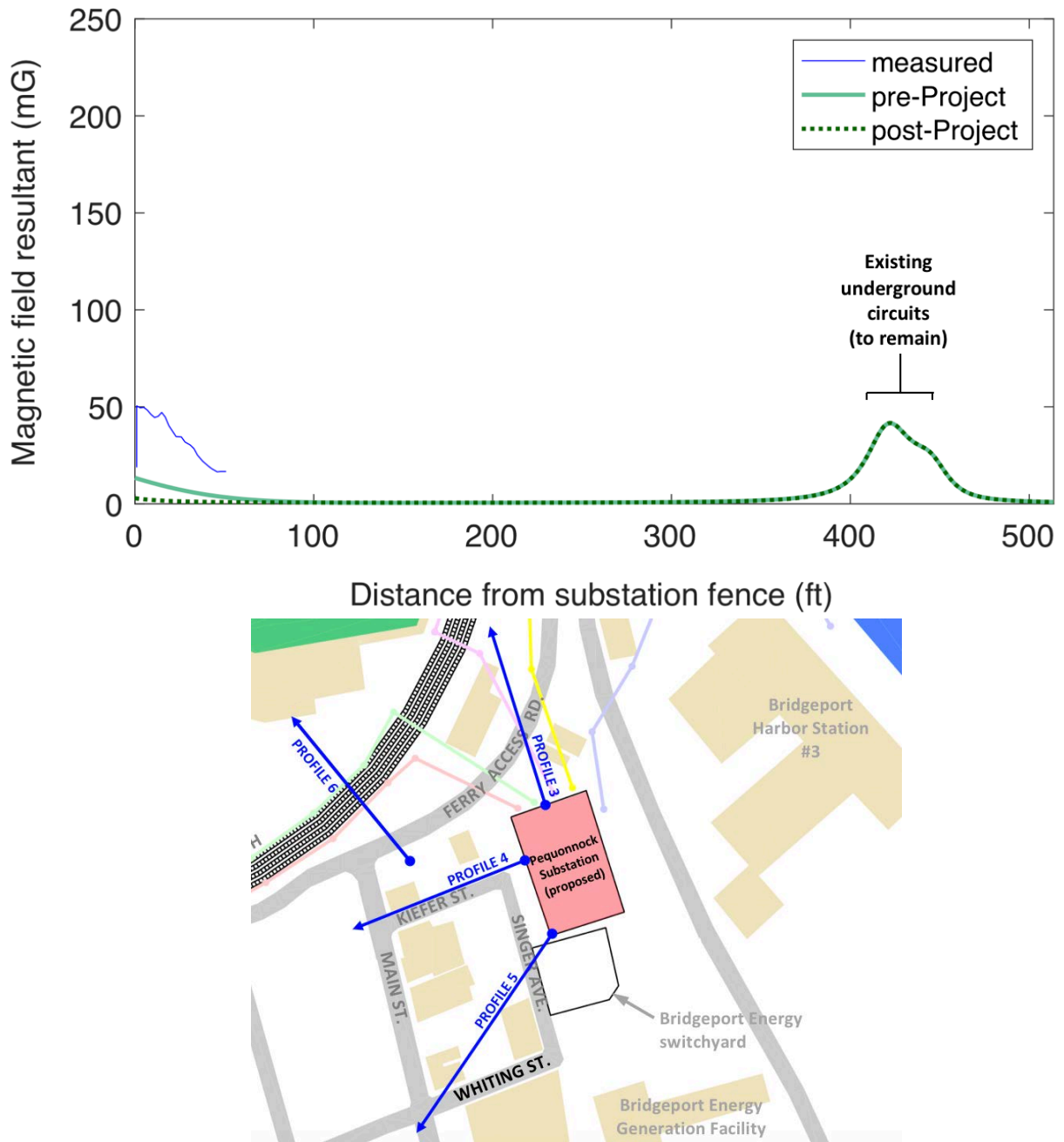

Figure 16. Calculated and measured magnetic-field levels along Profile 5.

The calculated magnetic-field levels are for existing and proposed configurations of the Pequot Substation under average-load conditions in 2027. Measured magnetic fields reflect existing substation and loading on November 15, 2017.

Calculated magnetic field Profile 6

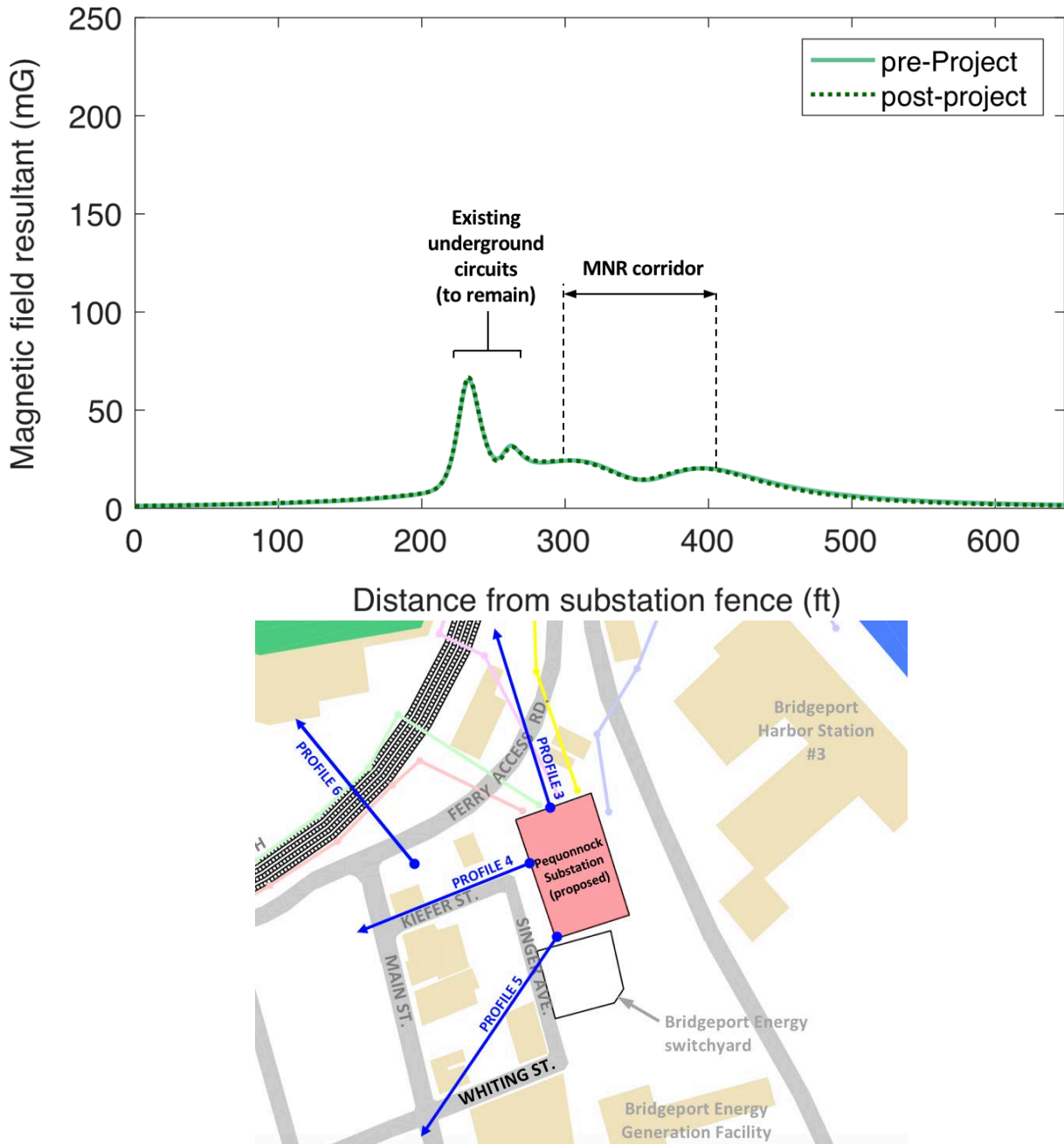

Figure 17. Calculated and measured magnetic-field levels along Profile 6.

The calculated magnetic-field levels are for existing and proposed configurations of the Pequonnock Substation under average-load conditions in 2027. Measured magnetic fields reflect existing substation and loading on November 15, 2017.

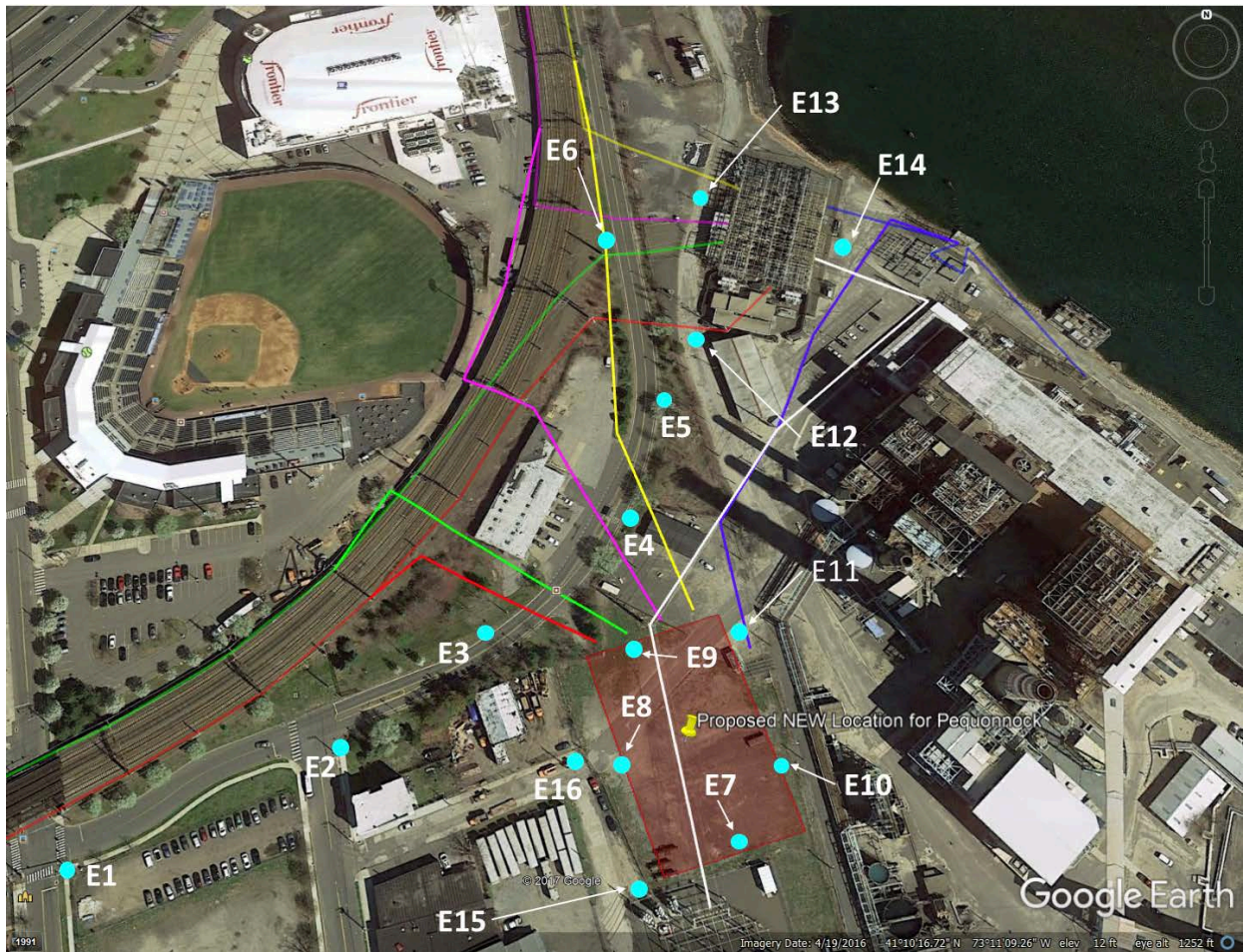

Figure 18. Locations of electric field-measurements.

Table 5. Summary of measured electric fields

Location (Figure 18)	Electric field (kV/m)			Resultant
	Vertical	North-South	East-West	
E1	0.000	0.000	0.005	0.005
E2	0.000	0.000	0.005	0.005
E3	0.005	0.000	0.037	0.037
E4	0.005	0.000	0.010	0.011
E5	0.005	0.005	0.016	0.017
E6	0.016	0.005	0.064	0.066
E7	0.000	0.000	0.005	0.005
E8	0.000	0.000	0.000	<0.005
E9	0.000	0.000	0.000	<0.005
E10	0.000	0.005	0.037	0.037
E11	0.000	0.000	0.016	0.016
E12	0.005	0.005	0.005	0.009
E13	0.058	0.021	0.107	0.123
E14	0.016	0.005	0.026	0.031
E15	0.000	0.005	0.005	0.007
E16	0.000	0.000	0.000	<0.005