

## JAHH-65B-R3B

**8-port sector antenna, 2x 698–787, 2x 824–894 and 4x 1695–2360 MHz, 65° HPBW, 3x RET and low bands have diplexers. Internal SBT's on first LB(Port 1) and first HB (Port 5).**

- Internal SBT on low and high band allow remote RET control from the radio over the RF jumper cable
- One RET for 700MHz, one RET for 850MHz, and one RET for both high bands to ensure same tilt level for 4x Rx or 4x MIMO
- Internal filter on low band and interleaved dipole technology providing for attractive, low wind load mechanical package
- Separate RS-485 RET input/output for low and high band

### Electrical Specifications

Frequency Band, MHz	698–787	824–894	1695–1880	1850–1990	1920–2200	2300–2360
Gain, dBi	14.5	15.8	18.0	18.4	18.5	18.8
Beamwidth, Horizontal, degrees	67	65	63	63	65	68
Beamwidth, Vertical, degrees	12.4	10.5	5.7	5.2	4.9	4.4
Beam Tilt, degrees	2–14	2–14	0–10	0–10	0–10	0–10
USLS (First Lobe), dB	18	18	20	20	21	23
Front-to-Back Ratio at 180°, dB	32	34	31	35	36	38
Isolation, dB	25	25	25	25	25	25
Isolation, Intersystem, dB	30	30	30	30	30	30
VSWR   Return Loss, dB	1.5   14.0	1.5   14.0	1.5   14.0	1.5   14.0	1.5   14.0	1.5   14.0
PIM, 3rd Order, 2 x 20 W, dBc	-153	-153	-153	-153	-153	-153
Input Power per Port, maximum, watts	350	350	350	350	350	300
Polarization	±45°	±45°	±45°	±45°	±45°	±45°
Impedance	50 ohm	50 ohm	50 ohm	50 ohm	50 ohm	50 ohm

### Electrical Specifications, BASTA\*

Frequency Band, MHz	698–787	824–894	1695–1880	1850–1990	1920–2200	2300–2360
Gain by all Beam Tilts, average, dBi	14.3	14.9	17.6	18.1	18.2	18.5
Gain by all Beam Tilts Tolerance, dB	±0.3	±0.5	±0.6	±0.4	±0.5	±0.6
Gain by Beam Tilt, average, dBi	2°   14.3	2°   15.0	0°   17.2	0°   17.6	0°   17.7	0°   17.9
Gain by Beam Tilt, average, dBi	8°   14.3	8°   14.9	5°   17.6	5°   18.2	5°   18.3	5°   18.7
Gain by Beam Tilt, average, dBi	14°   14.3	14°   15.4	10°   17.6	10°   18.2	10°   18.3	10°   18.7
Beamwidth, Horizontal Tolerance, degrees	±1.2	±1.4	±4	±2.4	±2.9	±2.7
Beamwidth, Vertical Tolerance, degrees	±0.9	±0.5	±0.3	±0.2	±0.3	±0.1
USLS, beampeak to 20° above beampeak, dB	18	17	17	18	19	18
Front-to-Back Total Power at 180° ± 30°, dB	25	24	26	29	27	29
CPR at Boresight, dB	22	23	20	21	21	24
CPR at Sector, dB	11	12	11	11	11	8

\* CommScope® supports NGMN recommendations on Base Station Antenna Standards (BASTA). To learn more about the benefits of BASTA, download the whitepaper [Time to Raise the Bar on BSAs](#).

### Array Layout

# Product Specifications

JAHH-65B-R3B

JAHH-65A-R3B JAHH-65B-R3B JAHH-65C-R3B

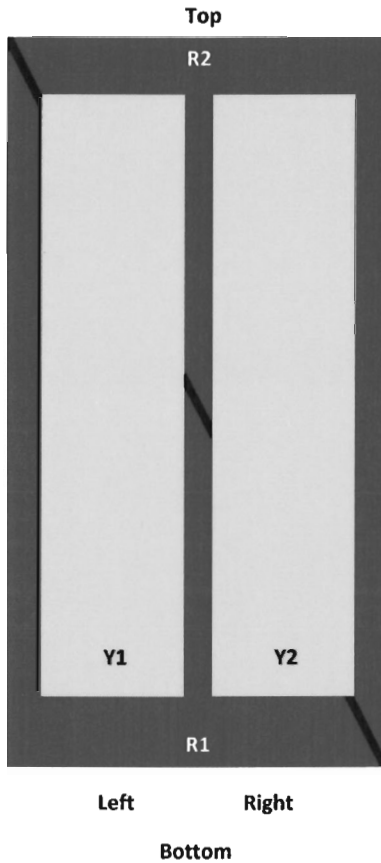

Array	Freq (MHz)	Conns	RET (SRET)	AISG RET UID
R1	698-798	1-2	1	AXXXXXXXXXXXXXXXXX1
R2	824-894	3-4	2	AXXXXXXXXXXXXXXXXX2
Y1	1695-2360	5-6	3	AXXXXXXXXXXXXXXXXX3
Y2	1695-2360	7-8		

View from the front of the antenna  
(Sizes of colored boxes are not true depictions of array sizes)

## General Specifications

Operating Frequency Band	1695 – 2360 MHz   698 – 787 MHz   824 – 894 MHz
Antenna Type	Sector
Band	Multiband
Performance Note	Outdoor usage

## Mechanical Specifications

RF Connector Quantity, total	8
RF Connector Quantity, low band	4
RF Connector Quantity, high band	4
RF Connector Interface	4.3-10 Female
Color	Light gray

# Product Specifications

COMMSCOPE®

JAHH-65B-R3B

Grounding Type	RF connector body grounded to reflector and mounting bracket
Radiator Material	Aluminum   Low loss circuit board
Radome Material	Fiberglass, UV resistant
Reflector Material	Aluminum
RF Connector Location	Bottom
Wind Loading, frontal	746.0 N @ 150 km/h 167.7 lbf @ 150 km/h
Wind Loading, lateral	243.0 N @ 150 km/h 54.6 lbf @ 150 km/h
Wind Loading, rear	776.0 N @ 150 km/h 174.5 lbf @ 150 km/h
Wind Speed, maximum	241 km/h   150 mph

## Dimensions

Length	1828.0 mm   72.0 in
Width	350.0 mm   13.8 in
Depth	208.0 mm   8.2 in
Net Weight, without mounting kit	28.7 kg   63.3 lb

## Remote Electrical Tilt (RET) Information

Input Voltage	10–30 Vdc
Internal Bias Tee	Port 1   Port 5
Internal RET	High band (1)   Low band (2)
Power Consumption, idle state, maximum	2.0 W
Power Consumption, normal conditions, maximum	13.0 W
Protocol	3GPP/AISG 2.0 (Single RET)
RET Interface	8-pin DIN Female   8-pin DIN Male
RET Interface, quantity	2 female   2 male

## Packed Dimensions

Length	1975.0 mm   77.8 in
Width	456.0 mm   18.0 in
Depth	357.0 mm   14.1 in
Shipping Weight	42.0 kg   92.6 lb

## Regulatory Compliance/Certifications

### Agency

RoHS 2011/65/EU  
China RoHS SJ/T 11364-2006  
ISO 9001:2008

### Classification

Compliant by Exemption  
Above Maximum Concentration Value (MCV)  
Designed, manufactured and/or distributed under this quality management system



# Product Specifications

COMMSCOPE®

JAHH-65B-R3B

## Included Products

BSAMNT-1 — Wide Profile Antenna Downtilt Mounting Kit for 2.4 - 4.5 in (60 - 115 mm) OD round members. Kit contains one scissor top bracket set and one bottom bracket set.

## \* Footnotes

Performance Note      Severe environmental conditions may degrade optimum performance

# ALCATEL-LUCENT B13 RRH4X30-4R

Alcatel-Lucent B13 Remote Radio Head 4x30-4R is the newest addition of Remote Radio Head to the extended product line of Alcatel-Lucent's distributed Base Station solutions, aimed at facilitating smooth RF site acquisition and related civil engineering.

**Supporting 2Tx/4Tx MIMO and 4-way Rx diversity**, Alcatel-Lucent B13 RRH4x30-4R allows operators to have a compact radio solution to deploy LTE in the 700U band (700 MHz, 3GPP band 13), providing them with the means to achieve high capacity, high quality and high coverage with minimum site requirements.

The Alcatel-Lucent B13 RRH4x30-4R product has four transmit RF paths, offering the possibility to **select, via software only, 2Tx or 4Tx MIMO configurations** with either 2x60 W or 4x30 W RF output power. It supports also 4-way Rx diversity and up to 10MHz instantaneous bandwidth.

The Alcatel-Lucent B13 RRH4x30-4R is a near zero-footprint solution and operates noise free, simplifying negotiations with site property owners and minimizing environmental impacts.

Its compactness and slim design makes the Alcatel-Lucent B13 RRH4x30-4R easy to install close to the antenna: operators can therefore locate this Remote Radio Head where RF design conditions are deemed ideal, minimizing trade-offs between available sites and RF optimum sites, together with reducing the RF feeder needs and installation costs.



## FEATURES

- Supporting LTE in 700 MHz band (700U, 3GPP band 13)
- LTE 2Tx or 4Tx MIMO (SW switchable)
- Output power: Up to 2x60W or 4x30W
- 10MHz LTE carrier with 4Rx Diversity
- Convection-cooled (fan-less)
- Supports AISG 2.0 ALD devices (RET, TMA) through RS485 or RF ports

## BENEFITS

- Compact to reduce additional footprint when adding LTE in 700U band
- MIMO scheme operation selection (2Tx or 4Tx) by software only
- Improves downlink spectral efficiency through MIMO4
- Increases LTE coverage thanks to 4Rx diversity capability and best in class Rx sensitivity
- Flexible mounting options: Pole or Wall

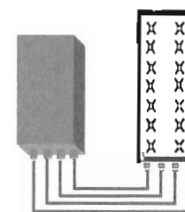

4x30W with 4T4R  
or  
2x60W with 2T4R  
Can be switched between  
modes via SW w/o site  
visit

## TECHNICAL SPECIFICATIONS

Features & performance	
<b>Number of TX/RX paths</b>	4 duplexed (either 4T4R or 2T4R by SW)
<b>Frequency band</b>	U700 (C) (3GPP bands 13): DL: 746 - 756 MHz / UL: 777 - 787 MHz
<b>Instantaneous bandwidth - #carriers</b>	10MHz – 1 LTE carrier (in 10MHz occupied bandwidth)
<b>LTE carrier bandwidth</b>	10 MHz
<b>RF output power</b>	2x60W or 4x30W (by SW)
<b>Noise figure – RX Diversity scheme</b>	2 dB typ. (<2.5 dB max) – 2 or 4 way Rx diversity
<b>Sizes (HxWxD) in mm (in.)</b>	550 x 305 x 230 (21.6" x 12.0" x 9") (with solar shield)
<b>Volume in L</b>	38 (with solar shield)
<b>Weight in kg (lb) (w/o mounting HW)</b>	26 (57.2) (with solar shield)
<b>DC voltage range</b>	-40.5 to -57V at full performance, -38 to -57V with relaxation on power consumption
<b>DC power consumption</b>	550W typical @100% RF load ( in 2Tx or 4Tx mode)
<b>Environmental conditions</b>	-40°C (-40°F) / +55°C (+131°F) IP65
<b>Wind load (@150km/h or 93mph)</b>	Frontal:<200N / Lateral :<150N
<b>Antenna ports</b>	4 ports 7/16 DIN female (50 ohms) VSWR < 1.5
<b>CPRI ports</b>	2 CPRI ports (HW ready for Rate7, 9.8 Gbps) SFP single mode dual fiber
<b>AISG interfaces</b>	1 AISG2.0 output (RS485) Integrated Smart Bias Tees (x2)
<b>Misc. Interfaces</b>	4 external alarms (1 connector) – 4 RF Tx & 4 RF Rx monitor ports - 1 DC connector (2 pins)
<b>Installation conditions</b>	Pole and wall mounting
<b>Regulatory compliance</b>	3GPP 36.141 / 3GPP 36.113 / GR-1089-CORE / GR-3108-CORE / UL 60950-1 / FCC Part 27

www.alcatel-lucent.com Alcatel, Lucent, Alcatel-Lucent and the Alcatel-Lucent logo are trademarks of Alcatel-Lucent. All other trademarks are the property of their respective owners. The information presented is subject to change without notice. Alcatel-Lucent assumes no responsibility for inaccuracies contained herein. Copyright © 2014 Alcatel-Lucent. All Rights Reserved

# ALCATEL-LUCENT B25 RRH4X30

Alcatel-Lucent Band 25 Remote Radio Head 4x30W is the new addition of Remote Radio Head to the extended product line of Alcatel-Lucent's distributed Base Station solutions, aimed at facilitating smooth RF site acquisition and related civil engineering.

**Supporting 2Tx/4Tx MIMO and 4-way Rx diversity**, Alcatel-Lucent B25 RRH4x30 allows operators to have a compact radio solution to deploy LTE in the PCS band (1.9 GHz, 3GPP band 25), providing them with the means to achieve high capacity, high quality and high coverage with minimum site requirements.

The Alcatel-Lucent B25 RRH4x30 product has four transmit RF paths, offering the possibility to **select, via software only, 2Tx or 4Tx MIMO configurations** with either 2x60 W or 4x30 W RF output power. It supports also 4-way Rx diversity, LTE carriers from 3 MHz up to 20 MHz and up to 65 MHz instantaneous bandwidth.

The Alcatel-Lucent B25 RRH4x30 is a near zero-footprint solution and operates noise free, simplifying negotiations with site property owners and minimizing environmental impacts.

Its compactness and slim design makes the Alcatel-Lucent B25 RRH4x30 easy to install close to the antenna: operators can therefore locate this Remote Radio Head where RF design conditions are deemed ideal, minimizing trade-offs between available sites and RF optimum sites, together with reducing the RF feeder needs and installation costs.



## FEATURES

- Supporting LTE in 1.9 GHz band (PCS, 3GPP band 2 & 25)
- LTE 2Tx or 4Tx MIMO (SW switchable)
- Output power: Up to 2x60W or 4x30W
- Ready for 3, 5, 10, 15 or 20MHz LTE carrier operation with 4Rx Diversity
- Ready to support up to 4 carriers anywhere in 65MHz instantaneous bandwidth
- Convection-cooled (fan-less)
- Supports AISG 2.0 devices (RET, TMA) through RS485 or RF ports

## BENEFITS

- Compact to reduce additional footprint when adding LTE in PCS band
- MIMO scheme operation selection (2Tx or 4Tx) by software only
- Full flexibility for multiple carriers operation over entire PCS spectrum
- Improves downlink spectral efficiency and cell edge throughput through MIMO4
- Increases LTE coverage thanks to 4-way Rx diversity capability and best in class Rx sensitivity
- Flexible mounting options (Pole or Wall)

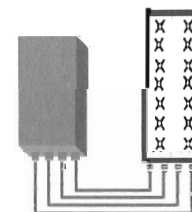

4x30W with 4T4R  
or  
2x60W with 2T4R

Can be switched between modes via SW w/o site visit

## TECHNICAL SPECIFICATIONS

Features & performance	
<b>Number of TX/RX paths</b>	4 duplexed (either 4T4R or 2T4R by SW)
<b>Frequency band</b>	3GPP bands 2 & 25 (PCS-G) DL: 1930 - 1995 MHz UL: 1850 - 1915 MHz
<b>Instantaneous bandwidth - #carriers</b>	65MHz – Up to 4 LTE carriers (in 40MHz occupied bandwidth)
<b>LTE carrier bandwidth</b>	3, 5, 10, 15 or 20 MHz
<b>RF output power</b>	2x60W or 4x30W (by SW)
<b>Noise figure (3GPP band 2)</b>	2.0 dB typ. (<2.5 dB max)
<b>RX Diversity scheme</b>	2 or 4 way Rx diversity
<b>Sizes (HxWxD)(w/ solar shield) in mm (in.)</b>	538 x 304 x 182 (21.2" x 12.0" x 7.2")
<b>Volume (w/ solar shield) in L</b>	30
<b>Weight (w/ solar shield) in kg (lb)</b>	24 (53)
<b>DC voltage range</b>	-40.5 to -57V at full performance, -38 to -57V with relaxation on power consumption
<b>DC power consumption</b>	580W typical @100% RF load
<b>Environmental conditions</b>	-40°C (-40°F) / +55°C (+131°F) IP65
<b>Wind load (@150km/h or 93mph)</b>	Frontal:<200N / Lateral :<150N
<b>Antenna ports</b>	4 ports 7/16 DIN female (50 ohms) VSWR < 1.5 (> 14dB)
<b>CPRI ports</b>	2 CPRI ports (HW ready for Rate7 / 9.8 Gbps)
<b>AISG interfaces</b>	1 AISG2.0 output (RS485), +24V/2A DC power Integrated Smart Bias Tees (x2)
<b>Misc. Interfaces</b>	1 external alarms connector (4 alarms) 4 RF Tx & 4 RF Rx monitor ports 1 DC connector (2 pins)
<b>Installation conditions</b>	Pole and wall mounting
<b>Regulatory compliance</b>	3GPP 36.141 / 3GPP 36.113 / GR-1089-CORE / GR-3108-CORE / UL 60950-1 / FCC Part 27

[www.alcatel-lucent.com](http://www.alcatel-lucent.com) Alcatel, Lucent, Alcatel-Lucent and the Alcatel-Lucent logo are trademarks of Alcatel-Lucent. All other trademarks are the property of their respective owners. The information presented is subject to change without notice. Alcatel-Lucent assumes no responsibility for inaccuracies contained herein. Copyright © 2014 Alcatel-Lucent. All Rights Reserved.



# ALCATEL-LUCENT B66A RRH4X45

The Alcatel-Lucent B66a Remote Radio Head 4x45 is the newest addition of Remote Radio Head to the extended product line of Alcatel-Lucent's distributed Base Station solutions, aimed at facilitating smooth RF site acquisition and related civil engineering. Its operational range covers beyond that of B4 (AWS) and B10 (AWS+).

**Supporting 2Tx/4Tx MIMO and 2-way/4-way Rx diversity**, the Alcatel-Lucent B66a RRH4x45 allows operators to have a compact radio solution to deploy LTE in the 2100 band (3GPP band 4, 10, and 66), providing them with the means to achieve high capacity, high quality, high reliability, large instantaneous bandwidth, and high coverage with minimum site requirements.

The Alcatel-Lucent B66a RRH4x45 product has four transmit RF paths, offering the possibility to **select, via software only, 2Tx or 4Tx MIMO configurations** with either 2x90W or 4x45W RF output power. It also supports 4-way Rx diversity at the 70 MHz instantaneous bandwidth.



The Alcatel-Lucent B66a RRH4x45 is a compact (near zero-footprint) solution and operates noise free, simplifying negotiations with site property owners and minimizing environmental impacts.

Its compactness and slim design makes the Alcatel-Lucent B66a RRH4x45 easy to install close to the antenna: operators can therefore locate this Remote Radio Head where RF design conditions are deemed ideal, minimizing trade-offs between available sites and RF optimum sites, together with reducing the RF feeder needs and installation costs.

## FEATURES

- Supporting LTE in 2110 - 2180 MHz band/DL, 1710-1780MHz/UL (3GPP band 4, 10, and 66a)
- LTE 2Tx or 4Tx MIMO (SW selectable)
- Configuration: 2T2R/2T4R/4T4R
- Output power: Up to 2x90W or 4x45W (SW configurable)
- 70MHz LTE carrier with 4Rx Diversity
- Convection-cooled (fan-less)
- Supports AISG 2.0 ALD devices (RET, TMA) through RS485 or RF ports

## BENEFITS

- Compact to reduce additional footprint when adding LTE in AWS 1-3 band
- Selection of MIMO configuration (2Tx or 4Tx) by software only
- Improves downlink spectral efficiency through 4Tx MIMO
- Increases LTE coverage thanks to 4Rx diversity capability and best in class Rx sensitivity
- Flexible mounting options: Pole or Wall

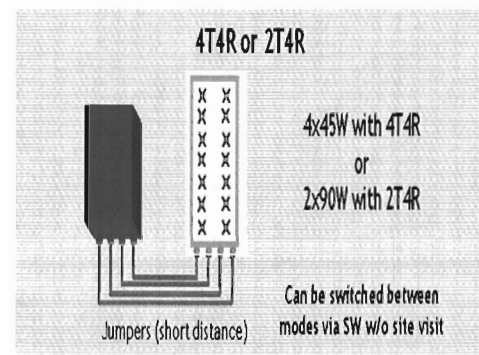

## TECHNICAL SPECIFICATIONS

	4 duplexed (either 4T4R or 2T4R selectable by SW)
	AWS 1-3, B4/B66a DL: 2110-2180 MHz / UL: 1710-1780 MHz
	70 MHz – 4 LTE MIMO carriers (in 70 MHz occupied bandwidth)
	5, 10, 15, 20 MHz
	2x90W or 4x45W (selectable by SW)
	2 dB typical (<2.5 dB max) – 2 or 4 way Rx diversity -104.5 dBm maximum
	655x299x182 (25.8x11.8x7.2) (with solar shield) 640x290x160 (25.2x11.4x6.3) (without solar shield) 35.5 (with solar shield) 29.7 (without solar shield) 25.8kg (56.8lb) (with solar shield)
	Nominal: -48V, -40.5 to -57V at full performance, -38 to -57V with relaxation on power consumption 750W typical @100% RF load (in 2Tx or 4Tx mode); Add 58W for 2A*29V for AISG
	-40°C (-40°F) / +55°C (+131°F) UL50E Type 4 Enclosure 250N (56lb) Frontal/150N (34lb) Lateral
	4 ports 4.3-10 female (50 ohms) VSWR < 1.5
	2 CPRI ports (HW ready for Rate 7, 9.8 Gbps) SFP: SMDF (HW supports also SMSF and MMDF)
	1 AISG 2.0 output (RS485) Integrated Smart Bias Tees (x2)
	4 external alarms (1 connector) 1 DC connector (2 pins)
	Pole and wall mounting
	3GPP 36.141 / 3GPP 36.113 / GR-487 / GR-1089-CORE / GR-3108-CORE / UL 60950-1 / FCC Part 27 / FCC Part 15 / GR-3178-CORE

www.alcatel-lucent.com Alcatel, Lucent, Alcatel-Lucent and the Alcatel-Lucent logo are trademarks of Alcatel-Lucent. All other trademarks are the property of their respective owners. The information presented is subject to change without notice. Alcatel-Lucent assumes no responsibility for inaccuracies contained herein. Copyright © 2016 Alcatel-Lucent. All Rights Reserved

**HYBRIFLEX™ RRH Hybrid Feeder Cabling Solution, 1-5/8", Single-Mode Fiber**

**Product Description**

RFS' HYBRIFLEX Remote Radio Head (RRH) hybrid feeder cabling solution combines optical fiber and DC power for RRHs in a single lightweight aluminum corrugated cable, making it the world's most innovative solution for RRH deployments.

It was developed to reduce installation complexity and costs at Cellular sites. HYBRIFLEX allows mobile operators deploying an RRH architecture to standardize the RRH installation process and eliminate the need for and cost of cable grounding. HYBRIFLEX combines optical fiber (multi-mode or single-mode) and power in a single corrugated cable. It eliminates the need for junction boxes and can connect multiple RRHs with a single feeder. Standard RFS CELLFLEX<sup>2</sup> accessories can be used with HYBRIFLEX cable. Both pre-connectorized and on-site options are available.

**Features/Benefits**

- Aluminum corrugated armor with outstanding bending characteristics – minimizes installation time and enables mechanical protection and shielding
- Same accessories as 1 5/8" coaxial cable
- Outer conductor grounding – Eliminates typical grounding requirements and saves on installation costs
- Lightweight solution and compact design – Decreases tower loading
- Robust cabling – Eliminates need for expensive cable trays and ducts
- Installation of tight bundled fiber optic cable pairs directly to the RRH – Reduces CAPEX and wind load by eliminating need for interconnection
- Optical fiber and power cables housed in single corrugated cable – Saves CAPEX by standardizing RRH cable installation and reducing installation requirements
- Outdoor polyethylene jacket – Ensures long-lasting cable protection

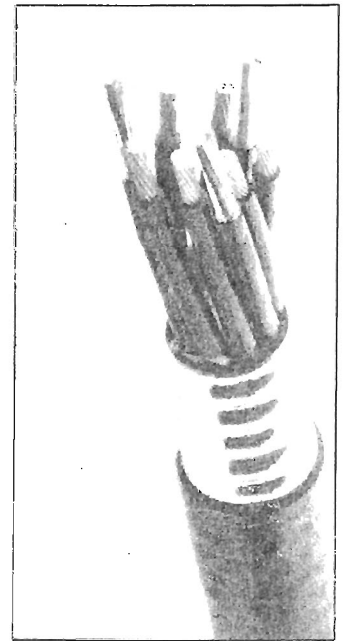

Figure 1: HYBRIFLEX Series

**Technical Specifications**

<b>Mechanical Properties</b>			
Outer Conductor Armor	Corrugated Aluminum	[mm (in)]	46.5 (1.83)
Jacket	Polyethylene, PE	[mm (in)]	50.3 (1.98)
UV-Protection	Individual and External Jacket		Yes
<b>Mechanical Properties</b>			
Weight, Approximate		[kg/m (lb/ft)]	1.9 (1.30)
Minimum Bending Radius, Single Bending		[mm (in)]	200 (8)
Minimum Bending Radius, Repeated Bending		[mm (in)]	500 (20)
Recommended/Maximum Clamp Spacing		[m (ft)]	1.0 / 1.2 (3.25 / 4.0)
<b>Electrical Properties</b>			
DC-Resistance Outer Conductor Armor		[Ω/km (Ω/1000ft)]	0.68 (0.205)
DC-Resistance Power Cable, 8.4mm <sup>2</sup> (8AWG)		[Ω/km (Ω/1000ft)]	2.1 (0.307)
<b>Optical Properties</b>			
Version			Single-mode OM3
Quantity, Fiber Count			16 (8 pairs)
Core/Clad		[μm]	50/125
Primary Coating (Acrylate)		[μm]	245
Buffer Diameter, Nominal		[μm]	900
Secondary Protection, Jacket, Nominal		[mm (in)]	2.0 (0.08)
Minimum Bending Radius		[mm (in)]	104 (4.1)
Insertion Loss @ wavelength 850nm		dB/km	3.0
Insertion Loss @ wavelength 1310nm		dB/km	1.0
Standards (Meets or exceeds)			UL94-V0, UL1666 RoHS Compliant
<b>DC Power Cable Properties</b>			
Size (Power)		[mm (AWG)]	8.4 (8)
Quantity, Wire Count (Power)			16 (8 pairs)
Size (Alarm)		[mm (AWG)]	0.8 (18)
Quantity, Wire Count (Alarm)			4 (2 pairs)
Type			UV protected
Strands			19
Primary Jacket Diameter, Nominal		[mm (in)]	6.8 (0.27)
Standards (Meets or exceeds)			NFPA 130, ICEA S-95-658 UL Type XHHW-2, UL 44 UL-LS Limited Smoke, UL VW-1 IEEE-383 (1974), IEEE1202/FT4 RoHS Compliant
<b>Environment</b>			
Installation Temperature		[°C (°F)]	-40 to +65 (-40 to 149)
Operation Temperature		[°C (°F)]	-40 to +65 (-40 to 149)

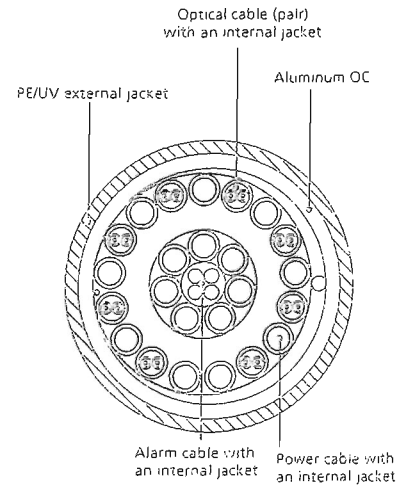

Figure 2: Construction Detail

All information contained in the present datasheet is subject to confirmation at time of ordering.

# GENERAC®

# INDUSTRIAL POWER

## SG035

## 5.4L

### Industrial Spark-Ignited Generator Set

EPA Certified Stationary Emergency

SG035 35 kW

Standby Power Rating  
**35 kW 44 kVA 60 Hz**

Prime Power Rating\*  
**32 kW 39 kVA 60 Hz**

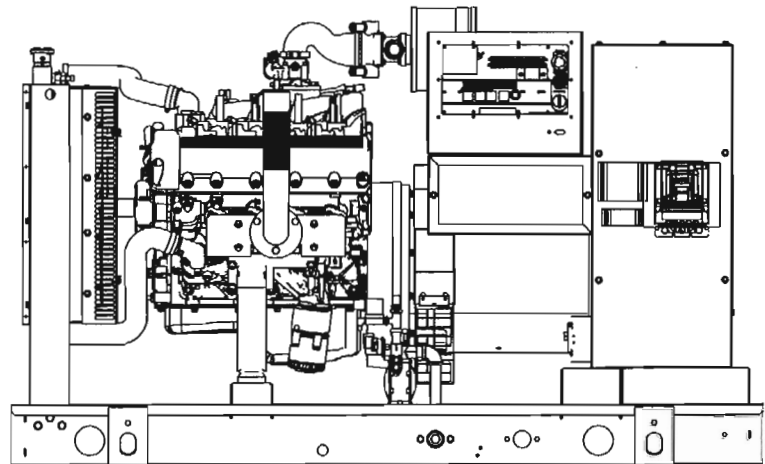

\*EPA Certified Prime ratings are not available in the U.S. or its Territories

Image used for illustration purposes only

## Codes and Standards

Generac products are designed to the following standards:



UL2200, UL508, UL142, UL498



NFPA70, 99, 110, 37



NEC700, 701, 702, 708



ISO9001, 8528, 3046, 7637, Pluses #2b, 4



NEMA ICS10, MG1, 250, ICS6, AB1



ANSI C62.41

American National Standards Institute



IBC 2009, CBC 2010, IBC 2012, ASCE 7-05,  
ASCE 7-10, ICC-ES AC-156 (2012)

## Powering Ahead

For over 50 years, Generac has led the industry with innovative design and superior manufacturing.

Generac ensures superior quality by designing and manufacturing most of its generator components, including alternators, enclosures and base tanks, control systems and communications software.

Generac's gensets utilize a wide variety of options, configurations and arrangements, allowing us to meet the standby power needs of practically every application.

Generac searched globally to ensure the most reliable engines power our generators. We choose only engines that have already been proven in heavy-duty industrial application under adverse conditions.

Generac is committed to ensuring our customers' service support continues after their generator purchase.

# SG035

## Standard Features

### ENGINE SYSTEM

#### General

- Oil Drain Extension
- Air Cleaner
- Fan Guard
- Stainless Steel flexible exhaust connection
- Critical Exhaust Silencer (enclosed only)
- Factory Filled Oil
- Radiator duct adapter (open set only)

#### Fuel System

- Primary and Secondary Fuel Shutoff
- Flexible Fuel Line - NPT Connection

#### Cooling System

- Closed Coolant Recovery System
- UV/Ozone resistant hoses
- Factory-installed Radiator
- Radiator drain extension
- 50/50 Ethylene glycol antifreeze

#### Engine Electrical System

- Battery charging alternator
- Battery Cables
- Battery Tray
- Solenoid activated starter motor
- Rubber-booted engine electrical connections

### ALTERNATOR SYSTEM

- UL2200 GENprotect™
- Class H insulation material
- 2/3 Pitch
- Skewed Stator
- Brushless Excitation
- Sealed Bearings
- Amortisseur winding
- Full load capacity alternator

### GENERATOR SET

- Internal Genset Vibration Isolation
- Separation of circuits - high/low voltage
- Separation of circuits - multiple breakers
- Wrapped Exhaust Piping
- Standard Factory Testing
- 2 Year Limited Warranty (Standby rated Units)
- 1 Year Warranty (Prime rated units)
- Silencer mounted in the discharge hood (enclosed only)

### ENCLOSURE (if selected)

- Rust-proof fasteners with nylon washers to protect finish
- High performance sound-absorbing material
- Gasketed doors
- Stamped air-intake louvers
- Air discharge hoods for radiator-upward pointing
- Stainless steel lift off door hinges
- Stainless steel lockable handles
- Rhino Coat™ - Textured polyester powder coat

## CONTROL SYSTEM



### Control Panel

- Digital H Control Panel - Dual 4x20 Display
- Programmable Crank Limiter
- 7-Day Programmable Exerciser
- Special Applications Programmable PLC
- RS-232/485
- All-Phase Sensing DVR
- Full System Status
- Utility Monitoring
- Low Fuel Pressure Indication
- 2-Wire Start Compatible
- Power Output (kW)
- Power Factor
- kW Hours, Total & Last Run

- Real/Reactive/Apparent Power
- All Phase AC Voltage
- All Phase Currents
- Oil Pressure
- Coolant Temperature
- Coolant Level
- Engine Speed
- Battery Voltage
- Frequency
- Date/Time Fault History (Event Log)
- Isochronous Governor Control
- Waterproof/sealed Connectors
- Audible Alarms and Shutdowns
- Not in Auto (Flashing Light)
- Auto/Off/Manual Switch
- E-Stop (Red Mushroom-Type)
- NFPA110 Level I and II (Programmable)
- Customizable Alarms, Warnings, and Events
- Modbus protocol
- Predictive Maintenance algorithm
- Sealed Boards
- Password parameter adjustment protection

- Single point ground
- 15 channel data logging
- 0.2 msec high speed data logging
- Alarm information automatically comes up on the display

### Alarms

- Oil Pressure (Pre-programmable Low Pressure Shutdown)
- Coolant Temperature (Pre-programmed High Temp Shutdown)
- Coolant Level (Pre-programmed Low Level Shutdown)
- Low Fuel Pressure Alarm
- Engine Speed (Pre-programmed Over speed Shutdown)
- Battery Voltage Warning
- Alarms & warnings time and date stamped
- Alarms & warnings for transient and steady state conditions
- Snap shots of key operation parameters during alarms & warnings
- Alarms and warnings spelled out (no alarm codes)

# SG035

## Configurable Options

### ENGINE SYSTEM

- General
- Engine Block Heater
- Oil Heater
- Air Filter Restriction Indicator
- Stone Guard (Open Set Only)
- Critical Exhaust Silencer (Open Set Only / Standard on Ultra Low Emissions Option)
- Engine Electrical System
- 10A UL battery charger
- 2.5A UL battery charger
- Battery Warmer

### ALTERNATOR SYSTEM

- Alternator Upsizing
- Anti-Condensation Heater
- Tropical coating
- Permanent Magnet Excitation

### CONTROL SYSTEM

- 21-Light Remote Annunciator
- Remote Relay Panel (8 or 16)
- Oil Temperature Sender with Indication Alarm

### GENERATOR SET

- Gen-Link Communications Software (English Only)
- Extended Factory Testing (3 Phase Only)
- IBC Seismic Certification
- 8 Position Load Center
- 2 Year Extended Warranty
- 5 Year Warranty
- 5 Year Extended Warranty

### CIRCUIT BREAKER OPTIONS

- Main Line Circuit Breaker
- 2nd Main Line Circuit Breaker
- Shunt Trip and Auxiliary Contact
- Electronic Trip Breakers

### ENCLOSURE

- Standard Enclosure
- Level 1 Sound Attenuation
- Level 2 Sound Attenuation
- Steel Enclosure
- Aluminum Enclosure
- 150 MPH Wind Kit
- 12 VDC Enclosure Lighting Kit
- 120 VAC Enclosure Lighting Kit
- AC/DC Enclosure Lighting Kit
- Door Alarm Switch

## Engineered Options

### ENGINE SYSTEM

- Coolant heater ball valves
- Fluid containment pans

### ALTERNATOR SYSTEM

- 3rd Breaker Systems

### GENERATOR SET

- Special Testing
- Battery Box

### ENCLOSURE

- Motorized Dampers
- Enclosure Ambient Heaters

### CONTROL SYSTEM

- Spare inputs (x4) / outputs (x4) - H Panel Only
- Battery Disconnect Switch

## Rating Definitions

**Standby** – Applicable for a varying emergency load for the duration of a utility power outage with no overload capability.

**Prime** – Applicable for supplying power to a varying load in lieu of utility for an unlimited amount of running time. A 10% overload capacity is available for 1 out of every 12 hours. The Prime Power option is only available on International applications.

Power ratings in accordance with ISO 8528-1, Second Edition dated 2005-06-01, definitions for Prime Power (PRP) and Emergency Standby Power (ESP).

**SG035**

**application and engineering data**

**ENGINE SPECIFICATIONS**

**General**

Make	Generac
Cylinder #	8
Type	V
Displacement - L (Cu In)	5.4 (329.53)
Bore - mm (in)	90.17 (3.55)
Stroke - mm (in)	105.92 (4.17)
Compression Ratio	9:1
Intake Air Method	Naturally Aspirated
Number of Main Bearings	4
Connecting Rods	Forged
Cylinder Head	Aluminum
Cylinder Liners	No
Ignition	Single Fire
Pistons	Aluminum Alloy
Crankshaft	Nodular Iron
Lifter Type	Hydraulic
Intake Valve Material	Steel Alloy
Exhaust Valve Material	Hardened Steel
Hardened Valve Seats	Yes

**Engine Governing**

Governor	Electronic
Frequency Regulation (Steady State)	+/- 0.25%

**Lubrication System**

Oil Pump Type	Gear
Oil Filter Type	Full-flow spin-on cartridge
Crankcase Capacity - L (qts)	5.7 (6)

**Cooling System**

Cooling System Type	Pressurized Closed Recovery
Water Pump Flow - gpm (lpm)	38 (144)
Fan Type	Pusher
Fan Speed (rpm)	2143
Fan Diameter mm (in)	508 (20)
Coolant Heater Wattage	1500
Coolant Heater Standard Voltage	120 V

**Fuel System**

Fuel Type	Natural Gas, Propane Vapor
Carburetor	Down Draft
Secondary Fuel Regulator	Standard
Fuel Shut Off Solenoid	Standard
Operating Fuel Pressure	7" - 11" H <sub>2</sub> O

**Engine Electrical System**

System Voltage	12 VDC
Battery Charging Alternator	Standard
Battery Size	See Battery Index 0161970SBY
Battery Voltage	12 VDC
Ground Polarity	Negative

**ALTERNATOR SPECIFICATIONS**

Standard Model	390
Poles	4
Field Type	Revolving
Insulation Class - Rotor	H
Insulation Class - Stator	H
Total Harmonic Distortion	<5%
Telephone Interference Factor (TIF)	<50
Standard Excitation	Brushless
Bearings	Sealed Ball
Coupling	Flexibile Disc
Prototype Short Circuit Test	Yes

Voltage Regulator Type	Full Digital
Number of Sensed Phases	All
Regulation Accuracy (Steady State)	+/- 0.25%

# SG035

# operating data

## POWER RATINGS

	Natural Gas		Propane Vapor	
	35 kW	Amps:	35 kW	Amps:
Single-Phase 120/240 VAC @1.0pf	35 kW	146	35 kW	146
Three-Phase 120/208 VAC @0.8pf	35 kW	121	35 kW	121
Three-Phase 120/240 VAC @0.8pf	35 kW	105	35 kW	105
Three-Phase 277/480 VAC @0.8pf	35 kW	53	35 kW	53
Three-Phase 346/600 VAC @0.8pf	35 kW	42	35 kW	42

## STARTING CAPABILITIES (sKVA)

		sKVA vs. Voltage Dip											
		480 VAC						208/240 VAC					
Alternator	kW	10%	15%	20%	25%	30%	35%	10%	15%	20%	25%	30%	35%
Standard	35	24	36	48	60	72	84	18	27	36	45	54	63
Upsize 1	40	27	41	54	68	81	95	20	31	41	51	61	71
Upsize 2	50	34	52	69	86	103	120	26	39	52	65	77	90
Upsize 3	60	42	63	83	104	125	146	32	47	62	78	94	110

## FUEL CONSUMPTION RATES\*

Natural Gas – ft <sup>3</sup> /hr (m <sup>3</sup> /hr)		Propane Vapor – ft <sup>3</sup> /hr (m <sup>3</sup> /hr)	
Percent Load	Standby	Percent Load	Standby
25%	239 (6.8)	25%	69.8 (2.0)
50%	409 (11.6)	50%	119.7 (3.4)
75%	553 (15.7)	75%	161.6 (4.6)
100%	682 (19.3)	100%	219.8 (6.2)

\*Fuel supply installation must accommodate fuel consumption rates at 100% load.

## COOLING

		Standby
Air Flow (inlet air combustion and radiator)	ft <sup>3</sup> /min (m <sup>3</sup> /min)	2460 (69.7)
Coolant Flow per Minute	gpm (lpm)	38 (144)
Coolant System Capacity	gal (L)	3 (11.36)
Heat Rejection to Coolant	BTU/hr	144,000
Max. Operating Air Temp on Radiator	°F (°C)	122 (50)
Max. Operating Ambient Temperature (before derate)	°F (°C)	110 (43.3)
Maximum Radiator Backpressure	in H <sub>2</sub> O	0.5

## COMBUSTION AIR REQUIREMENTS

	Standby
Flow at Rated Power cfm (m <sup>3</sup> /min)	87 (2.5)

## ENGINE

		Standby
Rated Engine Speed	rpm	1800
Horsepower at Rated kW**	hp	54
Piston Speed	ft/min (m/min)	1251 (381)
BMEP	psi	72

\*\* Refer to "Emissions Data Sheet" for maximum bHP for EPA and SCAQMD permitting purposes.

## EXHAUST

		Standby
Exhaust Flow (Rated Output)	cfm (m <sup>3</sup> /min)	260 (7.4)
Maximum Recommended Back Pressure	inHg	1.5
Exhaust Temp (Rated Output)	°F (°C)	900 (482)
Exhaust Outlet Size (Open Set)	in	2.5" I.D. Flex (No muffler)

Deration – Operational characteristics consider maximum ambient conditions. Derate factors may apply under atypical site conditions. Please consult a Generac Power Systems Industrial Dealer for additional details. All performance ratings in accordance with ISO3046, BS5514, ISO8528 and DIN6271 standards.



**SG035**

**dimensions and weights**

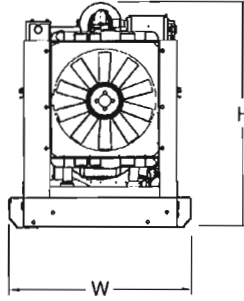
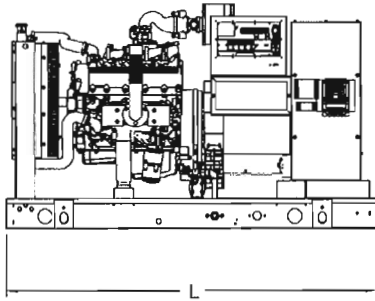

**OPEN SET (Includes Exhaust Flex)**

L x W x H in (mm)	76 (1930) x 37.4 (949.9) x 47 (1193.8)
Weight lbs (kg)	1575 (714)

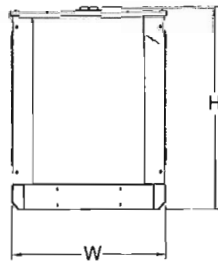
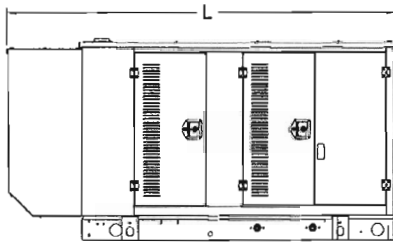

**STANDARD ENCLOSURE**

L x W x H in (mm)	94.8 (2408.9) x 38 (965.1) x 49.5 (1258.1)
Weight lbs (kg)	Steel: 2100 (952) Aluminum: 1754 (795)

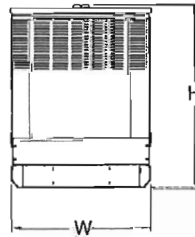
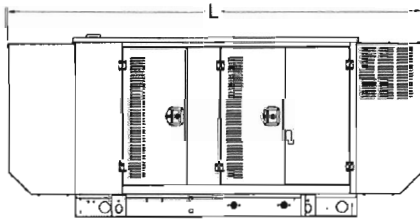

**LEVEL 1 ACOUSTIC ENCLOSURE**

L x W x H in (mm)	112.5 (2857.1) x 38 (965.1) x 49.5 (1258.1)
Weight lbs (kg)	Steel: 2140 (970) Aluminum: 1767 (801)

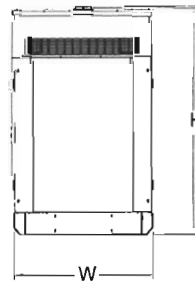
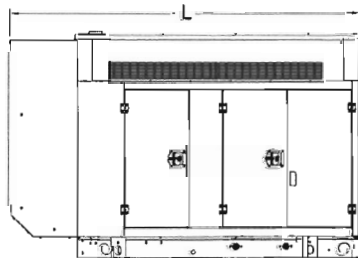

**LEVEL 2 ACOUSTIC ENCLOSURE**

L x W x H in (mm)	94.8 (2407) x 38 (965.1) x 62 (1573.9)
Weight lbs (kg)	Steel: 2328 (1056) Aluminum: 1831 (830)

**YOUR FACTORY RECOGNIZED GENERAC INDUSTRIAL DEALER**

Specification characteristics may change without notice. Please consult a Generac Power Systems Industrial Dealer for detailed installation drawings.